



Page 01–78

○ Cardiac & Vascular Instruments

MICRO NEEDLE HOLDERS

Castroviejo Micro Needle Holder

- Flat Handled
- Tungsten Carbide Jaws
- Straight 1.2mm Jaws



With Lock	Serrated Jaws	Smooth Jaws	Without Lock	Serrated Jaws	Smooth Jaws
13cm/5"	MCV101-13	MCV105-13	13cm/5"	MCV109-13	MCV113-13
18cm/7"	MCV102-18	MCV106-18	18cm/7"	MCV110-18	MCV114-18
20cm/8"	MCV103-20	MCV107-20	20cm/8"	MCV111-20	MCV115-20
21cm/8 ¹ / ₄ "	MCV104-21	MCV108-21	21cm/8 ¹ / ₄ "	MCV112-21	MCV116-21

Castroviejo Micro Needle Holder

- Flat Handled
- Diamond Dusted Jaws
- Straight 1.2mm Jaws



With Lock		WITHOUT LOCK	
14cm/5 ¹ / ₂ "	MCV117-14	14cm/5 ¹ / ₂ "	MCV120-14
18cm/7"	MCV118-18	18cm/7"	MCV121-18
21cm/8 ¹ / ₄ "	MCV119-21	21cm/8 ¹ / ₄ "	MCV122-21

Titanium Castroviejo Micro Needle Holder

- Flat Handled
- Diamond Dusted Jaws
- Straight 1.2mm Jaws



With Lock		Without Lock	
15cm/6"	MCV123-15T	15cm/6"	MCV127-15T
18cm/7"	MCV124-18T	18cm/7"	MCV128-18T
21cm/8 ¹ / ₄ "	MCV125-21T	21cm/8 ¹ / ₄ "	MCV129-21T
24cm/9 ¹ / ₂ "	MCV126-24T	24cm/9 ¹ / ₂ "	MCV130-24T

Reill Micro Needle Holder

- Round Bodied
- Diamond Dusted Jaws
- Delicate 1mm Jaws



With Lock	Straight	Curved	Without Lock	Straight	Curved
14.5cm/5 ³ / ₄ "	MCV131-14	MCV132-14	14.5cm/5 ³ / ₄ "	MCV133-14	MCV134-14

Jacobson Micro Needle Holder

- Round Bodied
- Diamond Dusted Jaws
- Straight Delicate 1mm Jaws



With Lock		Without Lock	
18cm/7"	MCV135-18	18cm/7"	MCV138-18
21cm/8 ¹ / ₄ "	MCV136-21	21cm/8 ¹ / ₄ "	MCV139-21
23cm/9"	MCV137-23	23cm/9"	MCV140-23

Titanium Jacobson Micro Needle Holder

- Round Bodied
- Diamond Dusted Jaws
- Straight



With Lock	Standard 1.2mm Jaws	Delicate 1mm Jaws	Without Lock	Standard 1.2mm Jaws	Delicate 1mm Jaws
15cm/6"	MCV141-15T	MCV141-1-15T	15cm/6"	MCV145-15T	MCV145-1-15T
18cm/7"	MCV142-18T	MCV142-1-18T	18cm/7"	MCV146-18T	MCV146-1-18T
21cm/8 ¹ / ₄ "	MCV143-21T	MCV143-1-21T	21cm/8 ¹ / ₄ "	MCV147-21T	MCV147-1-21T
23cm/9"	MCV144-23T	MCV144-1-23T	23cm/9"	MCV148-23T	MCV148-1-23T

MICRO NEEDLE HOLDERS

Jacobson Micro Needle Holder

- Round Bodied
- Tungsten Carbide Jaws
- 1.2mm Jaws



With Lock	Straight	Curved	Without Lock	Straight	Curved
15cm/6"	MCV149-15	MCV149-1-15	15cm/6"	MCV153-15	MCV153-1-15
18cm/7"	MCV150-18	MCV150-1-18	18cm/7"	MCV154-18	MCV154-1-18
21cm/8 ¹ / ₄ "	MCV151-21	MCV151-1-21	21cm/8 ¹ / ₄ "	MCV155-21	MCV155-1-21
23cm/9"	MCV152-23	MCV152-1-23	23cm/9"	MCV156-23	MCV156-1-23

Jacobson 'Heavy Style' Needle Holder

- Round Bodied
- Diamond Dusted Jaws
- For Larger Needles - 3/0 size
- Straight Jaws



With Lock		Without Lock	
18cm/7"	MCV157-18	18cm/7"	MCV160-18
23cm/9"	MCV158-23	23cm/9"	MCV161-23
25cm/10"	MCV159-25	25cm/10"	MCV162-25

Titanium Jacobson 'Heavy Style' Needle Holder

- Round Bodied
- Diamond Dusted Jaws
- For Larger Needles - 3/0 size
- Straight Jaws



With Lock		Without Lock	
18cm/7"	MCV163-18T	18cm/7"	MCV166-18T
23cm/9"	MCV164-23T	23cm/9"	MCV167-23T
25cm/10"	MCV165-25T	25cm/10"	MCV168-25T

Barraquer Micro Needle Holder

- Round Bodied
- 0.4mm Jaws



Without Lock	Straight	Curved
13cm/5"	MCV169-13	MCV172-13
15cm/6"	MCV170-15	MCV173-15
18cm/7"	MCV171-18	MCV174-18

Castroviejo Micro Needle Holder

- Flat Handled
- 0.4mm Jaws



Without Lock	Curved
14cm/5½"	MCV175-14
18cm/7"	MCV176-18

Double Action Micro Needle Holder

- Round Bodied
- 0.4mm Jaws



Without Lock	Curved
15cm/6"	MCV177-15
18cm/7"	MCV178-18

BAYONET MICRO NEEDLE HOLDERS

Yasargil Bayonet Micro Needle Holder

- Flat Handled
- Delicate 1mm Jaws



With Lock	Straight	Curved	Without Lock	Straight	Curved
23cm/9"	MCV179-23	MCV180-23	23cm/9"	MCV181-23	MCV182-23

Bayonet Micro Needle Holder

- Round Bodied
- Delicate 1mm Jaws



With Lock	Straight	Curved	Without Lock	Straight	Curved
21cm/8 ¹ / ₄ "	MCV183-21	MCV185-21	21cm/8 ¹ / ₄ "	MCV187-21	MCV189-21
23cm/9"	MCV184-23	MCV186-23	23cm/9"	MCV188-23	MCV190-23

Derf Needle Holder
12cm/4³/₄" TC

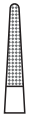

MCV191-12

Smooth



MCV192-12

Halsey Needle Holder
13cm/5" TC



MCV193-13

Smooth



MCV194-13

Nieverts Needle Holder (offset ring)
13cm/5" TC

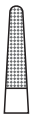

MCV195-13





RING HANDLED NEEDLE HOLDERS

Mayo Hegar Needle Holder

- Tungsten Carbide Inserts
- Heavy Jaws

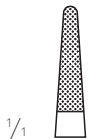
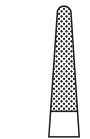
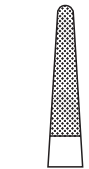
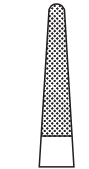

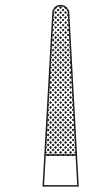
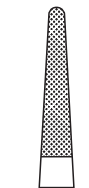
						
$\frac{1}{1}$						
14cm/5 $\frac{1}{2}$ "	16cm/6 $\frac{1}{4}$ "	18cm/7"	20cm/8"	23cm/9"	26cm/10 $\frac{1}{4}$ "	30cm/12"
MCV196-14	MCV197-16	MCV198-18	MCV199-20	MCV200-23	MCV201-26	MCV202-30

Crile Wood Needle Holder

- Tungsten Carbide Inserts
- Fine Jaws

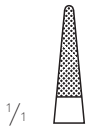
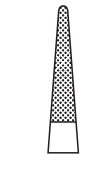
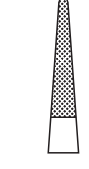
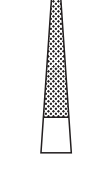
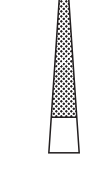

				
$\frac{1}{1}$				
15cm/6"	18cm/7"	20cm/8"	23cm/9"	26cm/10 $\frac{1}{4}$ "
MCV203-15	MCV204-18	MCV205-20	MCV206-23	MCV207-26

DeBaKey Needle Holder

- Tungsten Carbide Inserts
- Fine Jaws

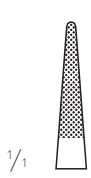
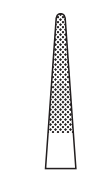
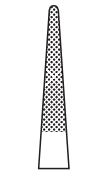
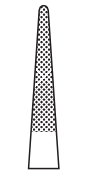

			
18cm/7"	23cm/9"	26cm/10¼"	30cm/12"
MCV208-18	MCV209-23	MCV210-26	MCV211-30

Micro Vascular Needle Holder

- Tungsten Carbide Inserts
- Slim Delicate Pattern

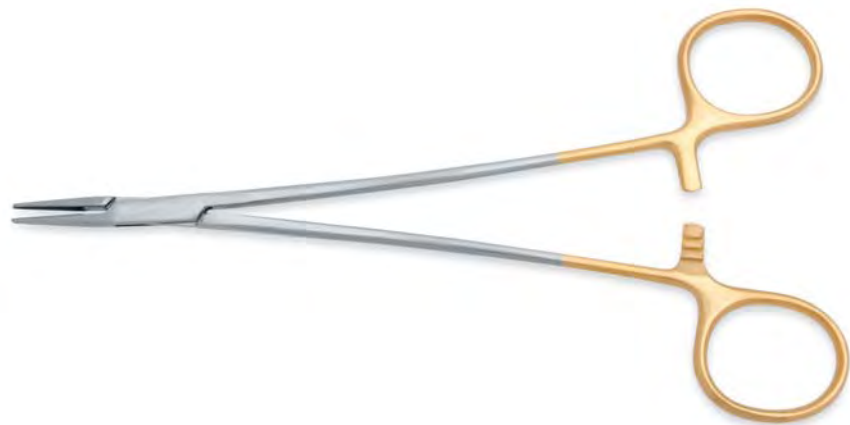

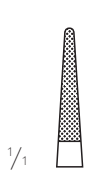
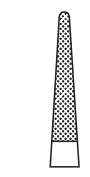
	
15cm/6"	18cm/7"
MCV212-15	MCV213-18



RING HANDLED NEEDLE HOLDERS

Micro Ryder Needle Holder

- Tungsten Carbide Inserts



1.4mm					
1/4					
13cm/5"	15cm/6"	18cm/7"	20cm/8"	23cm/9"	
MCV214-13	MCV215-15	MCV216-18	MCV217-20	MCV218-23	

French Eye (Ryder) Needle

- Tungsten Carbide Inserts



1.9mm			
1/4			
16cm/6 1/4"	18cm/7"	20cm/8"	26cm/10 1/4"
MCV219-16	MCV220-18	MCV221-20	MCV222-26

Fine Touch Needle Holder

- Diamond Dusted Jaws
- Delicate 1mm Jaws
- For 5/0 Sutures or smaller

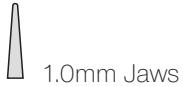

- 16cm/6¹/₄" **MCV223-16**
- 18cm/7" **MCV224-18**
- 22cm/8³/₄" **MCV225-22**



Stratte Needle Holder

- Tungsten Carbide Inserts
- Curved to side
- 23cm/9" length

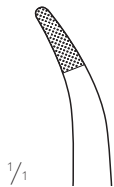

MCV226-23 *illustrated



MCV227-23 Stratte reverse



Berry Sternal Needle Holder

- Tungsten Carbide Inserts

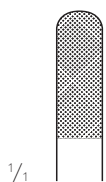

18cm/7"
MCV228-18



VASCULAR FORCEPS

DeBakey-Diethrich Atraumatic Tissue Forceps

- Fine 1.5mm Atraumatic Jaws



15cm/6"	MCV229-15
20cm/8"	MCV230-20
24cm/9½"	MCV231-24



1/1



DeBakey Atraumatic Tissue Forceps



	1.5mm Tips
15cm/6"	MCV232-15
20cm/8"	MCV233-20
24cm/9½"	MCV234-24



	2mm Tips
15cm/6"	MCV235-15
20cm/8"	MCV236-20
24cm/9½"	MCV237-24
30cm/12"	MCV238-30



	2.8mm Tips
15cm/6"	MCV239-15
20cm/8"	MCV240-20
24cm/9½"	MCV241-24
30cm/12"	MCV242-30



Titanium DeBakey Atraumatic Tissue Forceps



	1.5mm Tips
15cm/6"	MCV243-15T
20cm/8"	MCV244-20T
24cm/9½"	MCV245-24T



	2mm Tips
15cm/6"	MCV246-15T
20cm/8"	MCV247-20T
24cm/9½"	MCV248-24T



	2.8mm Tips
15cm/6"	MCV249-15T
20cm/8"	MCV250-20T
24cm/9½"	MCV251-24T



Gillies Dissecting Forceps

- 15cm/6" length
- Toothed

MCV252-15

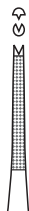

McIndoes Dissecting Forceps

- 15cm/6" length
- Non-Toothed

MCV253-15



Titanium Cushing Dissecting Forceps

- 18cm/7" length
- Serrated 1mm Tips

MCV254-18T



Adson Bayonet Dissecting Forceps

- 19cm/7½" length
- Flat Handled

MCV255-19 Serrated tip

MCV256-19 Toothed



VASCULAR FORCEPS

Gerald-DeBakey Forceps

- Flat Handled
- 1.2mm DeBakey Tips

17.5cm/6³/₄" **MCV257-17**

21cm/8¹/₄" **MCV258-21**



Titanium Gerald-DeBakey Forceps

- Flat Handled
- 1.2mm DeBakey Tips

17.5cm/6³/₄" **MCV259-17T**

21cm/8¹/₄" **MCV260-21T**



Gerald Tissue Forceps

- Flat Handled
- Tungsten Carbide Tips
- 1.2mm Tips

17.5cm/6³/₄" **MCV261-17**



Gerald Plain Forceps

- Flat Handled
- Diamond Dusted Tips
- 1mm Tips

17.5cm/6³/₄" **MCV262-17**



Gerald Platform Forceps

- Flat Handled
- Tying platform 6 x 1mm
- Diamond Dusted Tips



17.5cm/6³/₄" **MCV263-17**
 21cm/8¹/₄" **MCV264-21**



Titanium Gerald Platform Forceps

- Flat Handled
- Tying platform 6 x 1mm
- Diamond Dusted Tips



17.5cm/6³/₄" **MCV265-17T**
 21cm/8¹/₄" **MCV266-21T**



Gerald Micro Ring Tip Forceps

- Flat Handled
- 1mm Diamond Dusted Rings



17.5cm/6³/₄" **MCV267-17**
 21cm/8¹/₄" **MCV268-21**



Titanium Gerald Micro Ring Tip Forceps

- Flat Handled
- 1mm Diamond Dusted Rings



17.5cm/6³/₄" **MCV269-17T**
 21cm/8¹/₄" **MCV270-21T**



ROUND BODIED MICRO FORCEPS

Micro Platform Forceps

- Diamond Dusted Tips



18cm/7" **MCV271-18**

21cm/8¹/₄" **MCV272-21**



Titanium Micro Platform Forceps

- Diamond Dusted Tips



18cm/7" **MCV273-18T**

21cm/8¹/₄" **MCV274-21T**

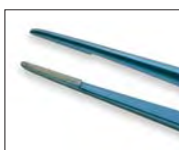

Micro Platform Forceps with Counter Balance

- Diamond Dusted Tips



18cm/7" **MCV275-18**

21cm/8¹/₄" **MCV276-21**



Titanium Micro Platform Forceps with Counter Balance

- Diamond Dusted Tips



18cm/7" **MCV277-18T**

21cm/8¹/₄" **MCV278-21T**



Micro Ring Tip Forceps

- Diamond Dusted 1mm Ring



18cm/7" **MCV279-18**

21cm/8¹/₄" **MCV280-21**



Titanium Micro Ring Tip Forceps

- Diamond Dusted 1mm Ring



18cm/7" **MCV281-18T**

21cm/8¹/₄" **MCV282-21T**



Micro Ring Tip Forceps with Counter Balance

- Diamond Dusted 1mm Ring



18cm/7" **MCV283-18**

21cm/8¹/₄" **MCV284-21**



Titanium Micro Ring Tip Forceps with Counter Balance

- Diamond Dusted 1mm Ring



18cm/7" **MCV285-18T**

21cm/8¹/₄" **MCV286-21T**



ROUND BODIED MICRO FORCEPS

DeBakey Micro Forceps

- Round Bodied
- 1mm DeBakey Tips



18cm/7" **MCV287-18**
 21cm/8¹/₄" **MCV288-21**

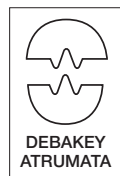

Titanium DeBakey Micro Forceps

- Round Bodied
- 1mm DeBakey Tips



18cm/7" **MCV289-18T**
 21cm/8¹/₄" **MCV290-21T**

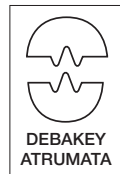

DeBakey Micro Forceps

- Round Bodied
- 1mm DeBakey Tips
- With Counterbalance



18cm/7" **MCV291-18**
 21cm/8¹/₄" **MCV292-21**

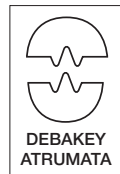

Bayonet Micro Forceps

- Round Bodied
- Blunt 1mm Tips



21cm/8¹/₄" **MCV293-21**

23cm/9" **MCV294-23**

Yasargil Bayonet Micro Forceps

- Flat Handed
- Blunt 1mm Tips



22.5cm/8¹/₄" **MCV295-22**

24cm/9¹/₂" **MCV296-24**

Yasargil Bayonet Tumor Grasping Forceps

- Flat Handed
- 22.5cm/8¹/₄" length



Plain Ring

3mm Ø **MCV297-22**

5mm Ø **MCV298-22**



Serrated Ring

3mm Ø **MCV299-22**

5mm Ø **MCV300-22**



Toothed Ring

3mm Ø **MCV301-22**

5mm Ø **MCV302-22**

BIPOLAR FORCEPS

Bayonet Micro Forceps

- Round Bodied
- Blunt 1mm Tips



21cm/8¹/₄" **MCV303-21**

23cm/9" **MCV304-23**

Yasargil Bayonet Micro Forceps

- Flat Handed
- Blunt 1mm Tips



22.5cm/8¹/₄" **MCV305-22**

24cm/9¹/₂" **MCV306-24**

Yasargil Bayonet Tumor Grasping Forceps

- Flat Handed
- 22.5cm/8¹/₄" length



Plain Ring

3mm Ø **MCV307-22**

5mm Ø **MCV308-22**



Serrated Ring

3mm Ø **MCV309-22**

5mm Ø **MCV310-22**



Toothed Ring

3mm Ø **MCV311-22**

5mm Ø **MCV312-22**

Bayonet Bipolar Forceps

- 19cm/7¹/₂" length



Tip Size

- 0.7mm **MCV313-83**
- 1mm **MCV314-81**
- 2mm **MCV315-82**

Bayonet Bipolar Forceps

- 22.5cm/8³/₄" length



Tip Size

- 0.3mm **MCV316-90**
- 0.7mm **MCV317-91**
- 1.2mm **MCV318-92**

Bayonet Bipolar Forceps

- 24cm/9¹/₂" length



Tip Size

- 0.3mm **MCV319-90**
- 0.7mm **MCV320-91**
- 1.2mm **MCV321-92**

MCV322-35L



- Fitting Block End Forceps
- Banana Plug Vallylab Machine Fitting
- 4.5 metre length

MCV323-38L



- Fitting Block End Forceps
- Erbe BM780 Machine Fitting
- 4.5 metre length



BIPOLAR FORCEPS

Bayonet Bipolar Coagulation Forceps

- 22.5cm/8³/₄" length
- Non-Stick Tips
- Mallis 2 Pin Fitting



Tip Size

- 0.5mm **MCV324-AU**
- 0.7mm **MCV325-AUS/0.7**
- 1.0mm **MCV326-AU**
- 1.3mm **MCV327-AUS**
- 1.5mm **MCV328-AU**
- 2.0mm **MCV329-AUS**



Iris Scissors

- 11.5cm/4½" Straight
- Micro Serrated Cutting Edge

MCV331-11



Iris Scissors

- 11.5cm/4½" Curved
- Micro Serrated Cutting Edge

MCV332-11

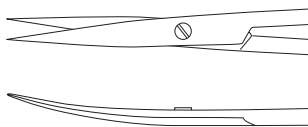

Strabismus Scissors

- 11.5cm/4½" Straight
- Micro Serrated Cutting Edge

MCV333-11



Strabismus Scissors

- 11.5cm/4½" Curved
- Micro Serrated Cutting Edge

MCV334-11





SCISSORS

Stevens Tenotomy Scissors

- 11.5cm/4½" Curved
- Micro Serrated Cutting Edge

MCV335-11

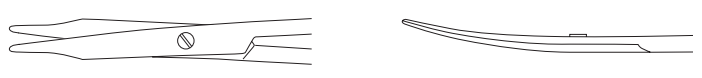

Stevens-Stillle Pattern Tenotomy Scissors

- 12.5cm/5" Curved
- Micro Serrated Cutting Edge
- Larger Oversized Rings

MCV336-12



Jameson-Werber Scissors

- 13.5cm/5¼" Curved
- Micro Serrated Cutting Edge

MCV337-13



Jameson Scissors

- 15cm/6" Curved
- Micro Serrated Cutting Edge

MCV338-15



Jameson Scissors

- 15cm/6" Curved
- **Strong pattern**
- Micro Serrated Cutting Edge

MCV339-15

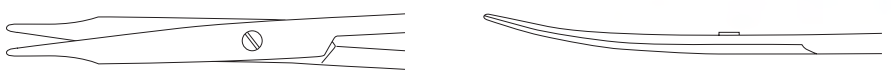

Slim Baby Metzenbaum Easy-Cut Scissors

- 14cm/5½" Curved
- Micro Serrated Cutting Edge

MCV340-14

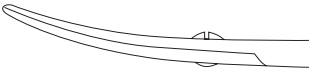

Slim Metzenbaum Easy-Cut Scissors

- 18cm/7" Curved
- Micro Serrated Cutting Edge

MCV341-18

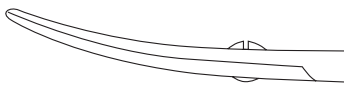

Baby Metzenbaum Easy-Cut Scissors

- 14cm/5½" Curved
- Micro Serrated Cutting Edge

MCV342-14



McIndoe / Metzenbaum Easy-Cut Scissors

- 18cm/7" Curved
- Micro Serrated Cutting Edge

MCV343-18



Nelson Metzenbaum Easy-Cut Scissors

- 23cm/9" Curved
- Micro Serrated Cutting Edge

MCV344-23





SCISSORS

Mayo Easy-Cut Scissors

- 14cm/5½" Straight
- Micro Serrated Cutting Edge

MCV345-14



Mayo Easy-Cut Scissors

- 14cm/5½" Curved
- Micro Serrated Cutting Edge

MCV346-14

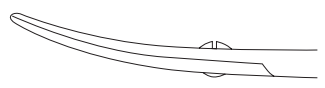

Mayo Easy-Cut Scissors

- 17cm/6¾" Straight
- Micro Serrated Cutting Edge

MCV347-17



Mayo Easy-Cut Scissors

- 17cm/6¾" Curved
- Micro Serrated Cutting Edge

MCV348-17



Diethrich Coronary Scissors - Standard Pattern

- 18cm/7" length
- Needle Fine Tips
- Polished Fine Blades
- 12mm Blade length

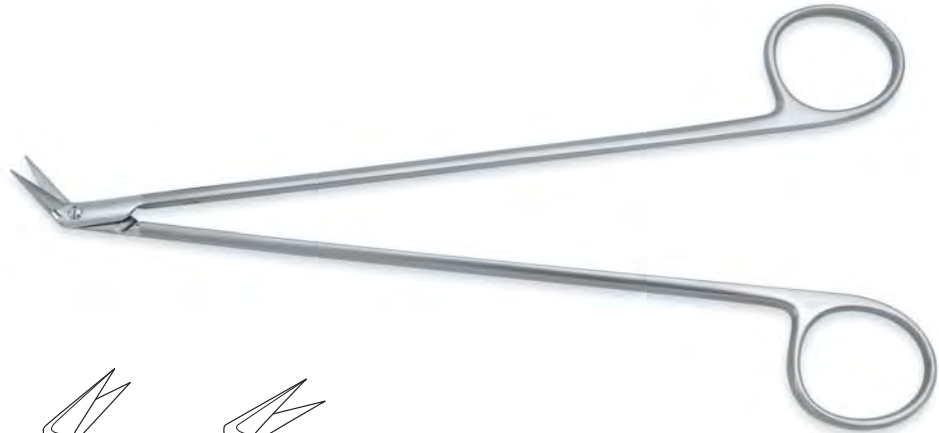

25° angled
MCV349-18



45° angled
MCV350-18



60° angled
MCV351-18

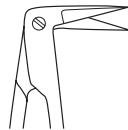

90° angled
MCV352-18



125° angled
MCV353-18

Diethrich Coronary Scissors - Short Fine Blade

- 18cm/7" length
- Needle Fine Tips
- Precise Polished Blades
- 8mm Blade length



25° angled
MCV354-18S



45° angled
MCV355-18S



60° angled
MCV356-18S



90° angled
MCV357-18S



125° angled
MCV358-18S

DIETHRICH SCISSORS

Diethrich Coronary Scissors - **Extra Long Delicate Blades**

- 18cm/7" length
- Needle Fine Tips
- Precise Polished Blades
- 15mm Blade length

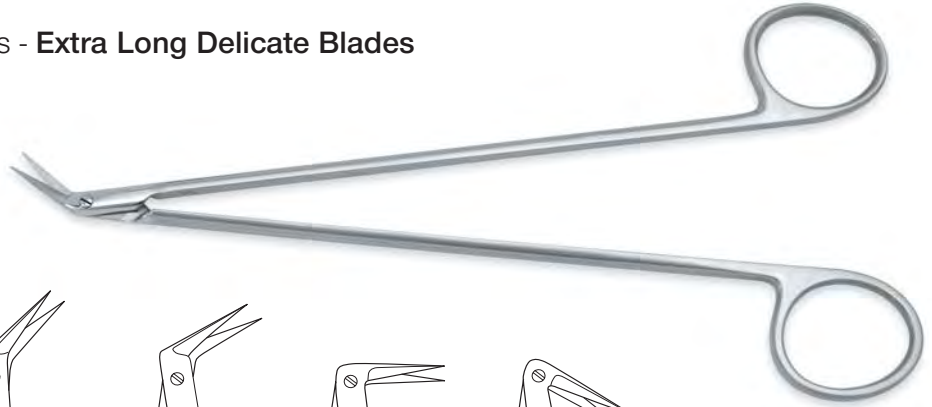

25° angled
MCV359-18L



45° angled
MCV360-18L



60° angled
MCV361-18L

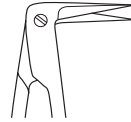

90° angled
MCV362-18L

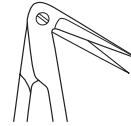

125° angled
MCV363-18L

Diethrich Coronary Scissors - **with Guide Rail**

- 18cm/7" length
- 12mm Blade length

125° angled blades

MCV364-18G

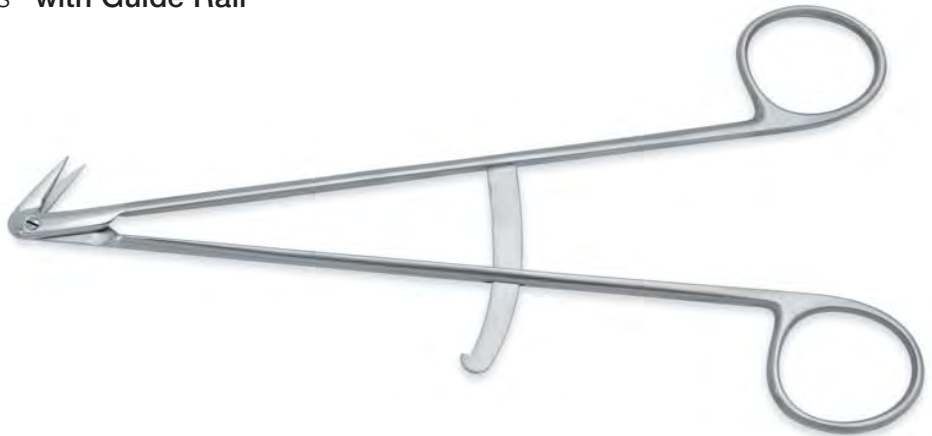

Favaloro Coronary Scissors

- 17cm/6³/₄" length
- 12mm Blade length

125° angled blades

MCV365-18



Potts-Smith Vascular Scissors

- 19cm/7¹/₂" length
- Blades angled to side

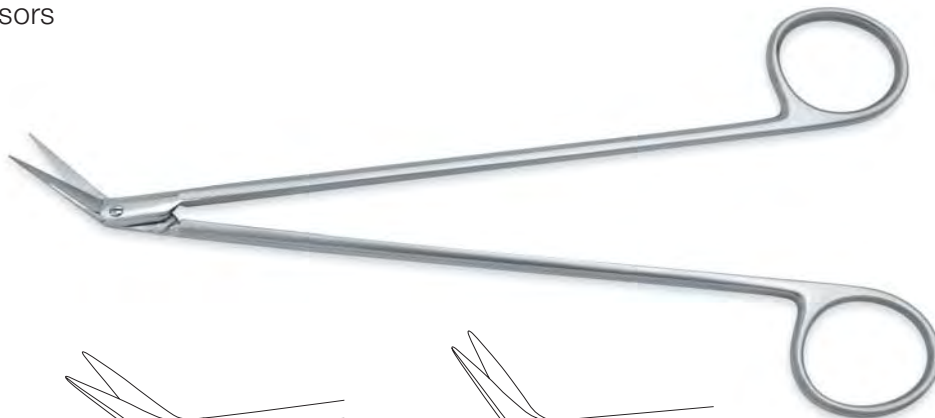

25° angled

MCV366-19

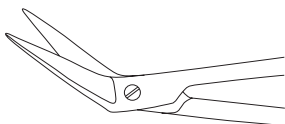

45° angled

MCV367-19

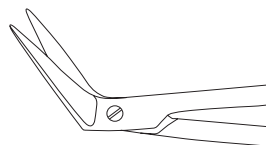

60° angled

MCV368-19

Jacobson Bayonet Micro Scissors

- Flat Handled
- 18cm/7" length



Straight

MCV369-18

Curved

MCV370-18

Yasargil Bayonet Micro Scissors

- Flat Handled
- 22.5cm/8³/₄" length



Standard Blade



Straight

MCV371-22

Vannas Blade



Straight

MCV373-22



Curved

MCV372-22



Curved

MCV374-22



MICRO CORONARY SCISSORS

Castroviejo Micro Scissors

- Flat Handled
 - 9cm/3" length
 - 45° Angled Blades
 - 14mm Blade length
- MCV375-90**



Castroviejo Micro Scissors

- Round Handled
 - 11cm/4 1/2" length
 - 45° Angled Blades
 - 14mm Blade length
- MCV376-11**



Micro Coronary Scissors - Standard 10mm Blades

- Round Handled - **Short length**
- 14cm/5 1/2" length
- Blades angled to side



25° angled
MCV377-14



45° angled
MCV378-14



60° angled
MCV379-14



90° angled
MCV380-14



125° angled
MCV381-14

Micro Coronary Scissors - **Standard 10mm Blades**

- Round Handled
- 18cm/7" length
- Blades angled to side



25° angled
MCV382-18



45° angled
MCV383-18

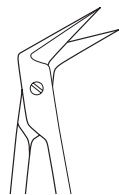

60° angled
MCV384-18

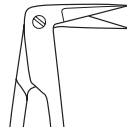

90° angled
MCV385-18



125° angled
MCV386-18

Micro Coronary Scissors - **Short Fine 8mm Blades**

- Round Handled
- 18cm/7" length
- Blades angled to side



25° angled
MCV387-18



45° angled
MCV388-18



60° angled
MCV389-18



90° angled
MCV400-18



125° angled
MCV401-18



MICRO CORONARY SCISSORS

Micro Coronary Scissors - Standard 10mm Blades

- Flat Handled
- 18cm/7" length
- Blades angled to side



25° angled
MCV402-18



45° angled
MCV403-18

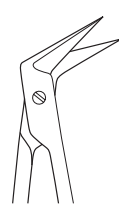

60° angled
MCV404-18

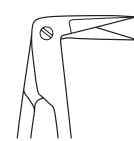

90° angled
MCV405-18



125° angled
MCV406-18

Micro Coronary Scissors - Short Fine 8mm Blades

- Flat Handled
- 18cm/7" length
- Blades angled to side



25° angled
MCV407-18

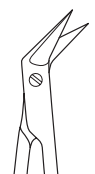

45° angled
MCV408-18



60° angled
MCV409-18



90° angled
MCV410-18



125° angled
MCV411-18

Straight Micro Scissors

- Flat Handled
 - 15cm/6" length
 - Blades 19mm long
- MCV412-15**



Adventitia Scissors with pointed tips

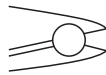

MCV413-15

Available with Micro Serrations for nerve cutting - **Straight**

Curved Micro Scissors

- Flat Handled
 - 15cm/6" length
 - Blades 19mm long
- MCV414-15**



Dissecting Scissors with rounded tips

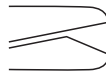

MCV415-15

Available with Micro Serrations for nerve cutting - **Curved**

Straight Micro Scissors

- Flat Handled
 - 15cm/6" length
 - Blades 15mm long
- MCV416-15**



Adventitia Scissors with pointed tips

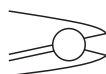

Curved Micro Scissors

- Flat Handled
 - 15cm/6" length
 - Blades 15mm long
- MCV417-15**



Dissecting Scissors with rounded tips



MICRO SCISSORS

Straight Micro Scissors

- Round Handled
 - 15cm/6" length
 - Blades 12mm long
- MCV418-15R8**



Adventitia Scissors with pointed tips

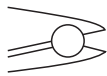

Curved Micro Scissors

- Round Handled
 - 15cm/6" length
 - Blades 12mm long
- MCV419-15R8**



Dissecting Scissors with rounded tips

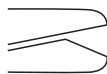

Straight Micro Scissors

- Round Handled
 - 18cm/7" length
 - Blades 14mm long
- MCV420-18R8**



Adventitia Scissors with pointed tips

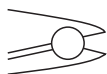

Curved Micro Scissors

- Round Handled
 - 18cm/7" length
 - Blades 14mm long
- MCV421-18R8**



Dissecting Scissors with rounded tips



Titanium Neonates Sternal Spreader

- Including 2 pairs of Interchangeable Blades
- 52mm spread, 40mm arm length

MCV422-14



Fenestrated
Blades x2
10mm width
15mm depth



Solid
Blades x2
20mm width
15mm depth



Morse-Favaloro Sternal Spreader

- Double Swivel Blades

Code	Arm length	Blade depth	Size
MCV423-12	55mm	12mm	Infant
MCV424-13	70mm	13mm	Infant
MCV425-14	80mm	14mm	Paediatric
MCV426-15	95mm	15mm	Paediatric
MCV427-16	110mm	19mm	Adolescent
MCV428-19	130mm	19mm	Adolescent
MCV429-21	145mm	21mm	Adolescent



Waterston Rib Spreader

- Infant size

MCV430-20



Arm length	Blade width	Blade depth
195mm	40mm	20mm



RIB SPREADERS

Finochietto Rib Spreader

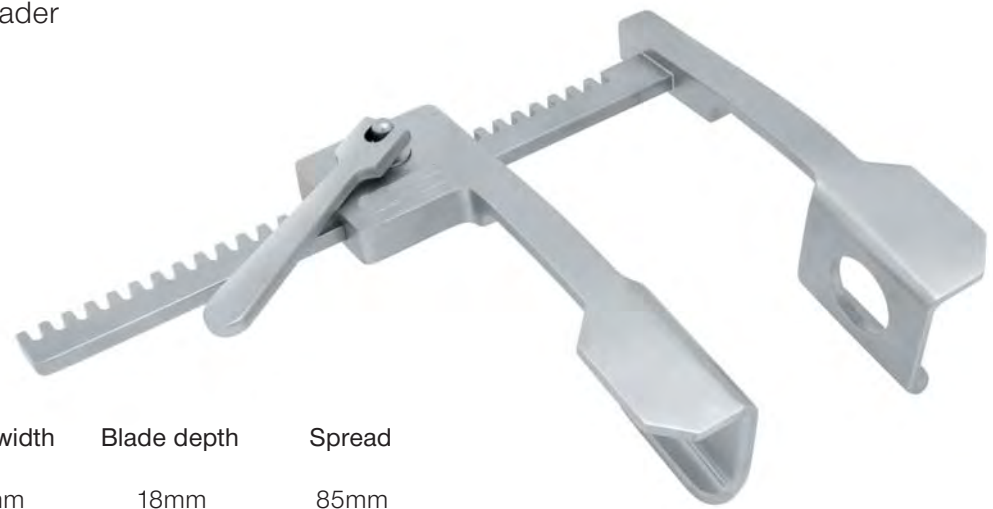

Code	Blade width	Blade depth	Spread
MCV431-18	21mm	18mm	85mm
MCV432-36	45mm	36mm	150mm
MCV433-44	65mm	44mm	225mm
MCV434-50	60mm	50mm	225mm
MCV435-65	65mm	65mm	225mm

Sellors Rib Spreader

MCV436-00

Supplied with set of 3 sizes of Blades and Key

- Small Blade 38mm Depth
- Medium Blade 45mm Depth
- Large Blade 65mm Depth

- Max spread 225mm



38mm Depth Small Blade



45mm Depth Medium Blade



65mm Depth Large Blade



Key

Tuffier Rib Spreader

MCV437-50



Blade width	Blade depth
45mm	50mm

Tudor Edwards Modified Tuffier Rib Spreader

- Complete with key

MCV438-35



Blade width	Blade depth
25mm	35mm

Key

Tudor Edwards Rib Spreader

MCV439-00

Supplied with set of 3 sizes of Blades and Key

Small Blade	25mm Depth
Medium Blade	50mm Depth
Large Blade	75mmDepth



25mm Depth
Small Blade



50mm Depth
Medium Blade



75mm Depth
Large Blade



Key



RIB SPREADERS

Ronald Edwards Rib Spreader

- Curved arms, fenestrated Blades

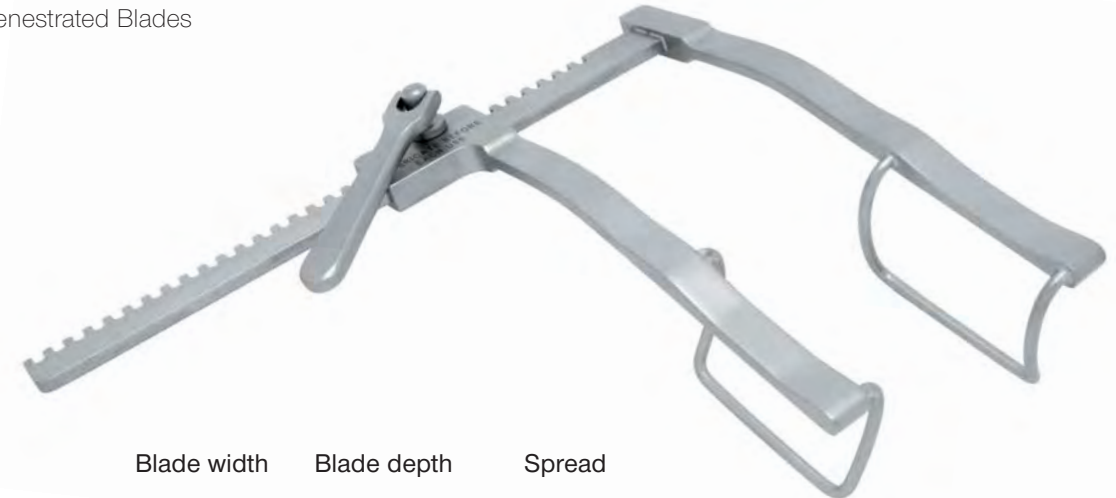

Code		Blade width	Blade depth	Spread
MCV440-50	Medium	30mm	50mm	135mm
MCV441-75	Large	65mm	75mm	205mm

Papworth Rib Spreader

- 225mm spread

MCV442-25



Blade width	Blade depth
65mm	25mm

Sellors Rib Approximator and Spreader Combined

- 20cm/8" length

MCV443-00



IMA Rib Retractor

- Complete Set for Internal Mammary Artery Surgery
- Converts left or right side

Complete set includes:

- Frame
- Channelled Blade 100mm
- Claw Blade short 28mm

- Claw Blade long 32mm

MCV444-00

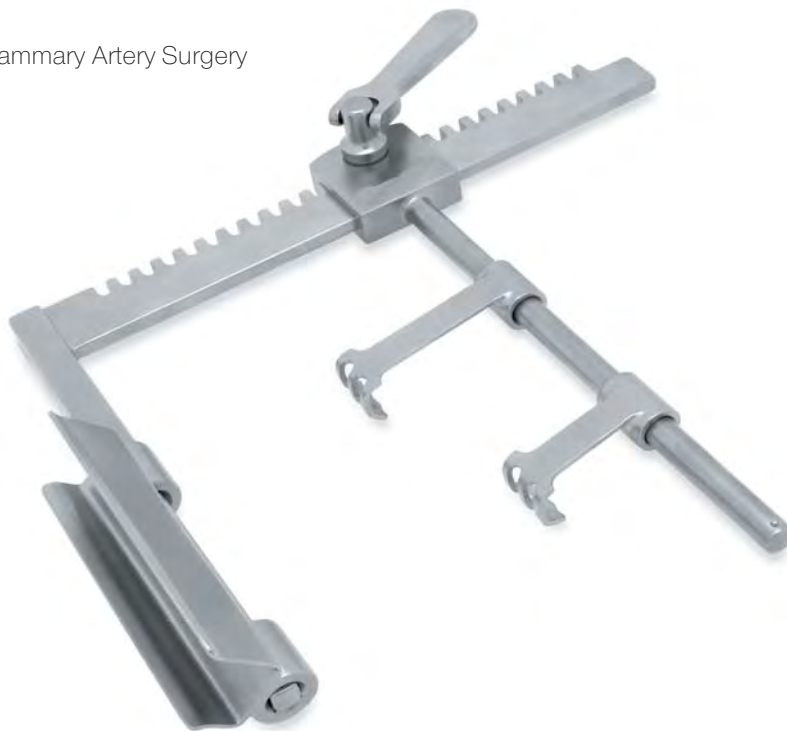

Channeled Blade

- 100mm long x 20mm wide



Claw Blades



Lengths

- 28mm *
- 32mm *
- 38mm
- 43mm
- 50mm

* included in Set



RIB SPREADERS

Cooley Cosgrove Mitral Valve Retractor

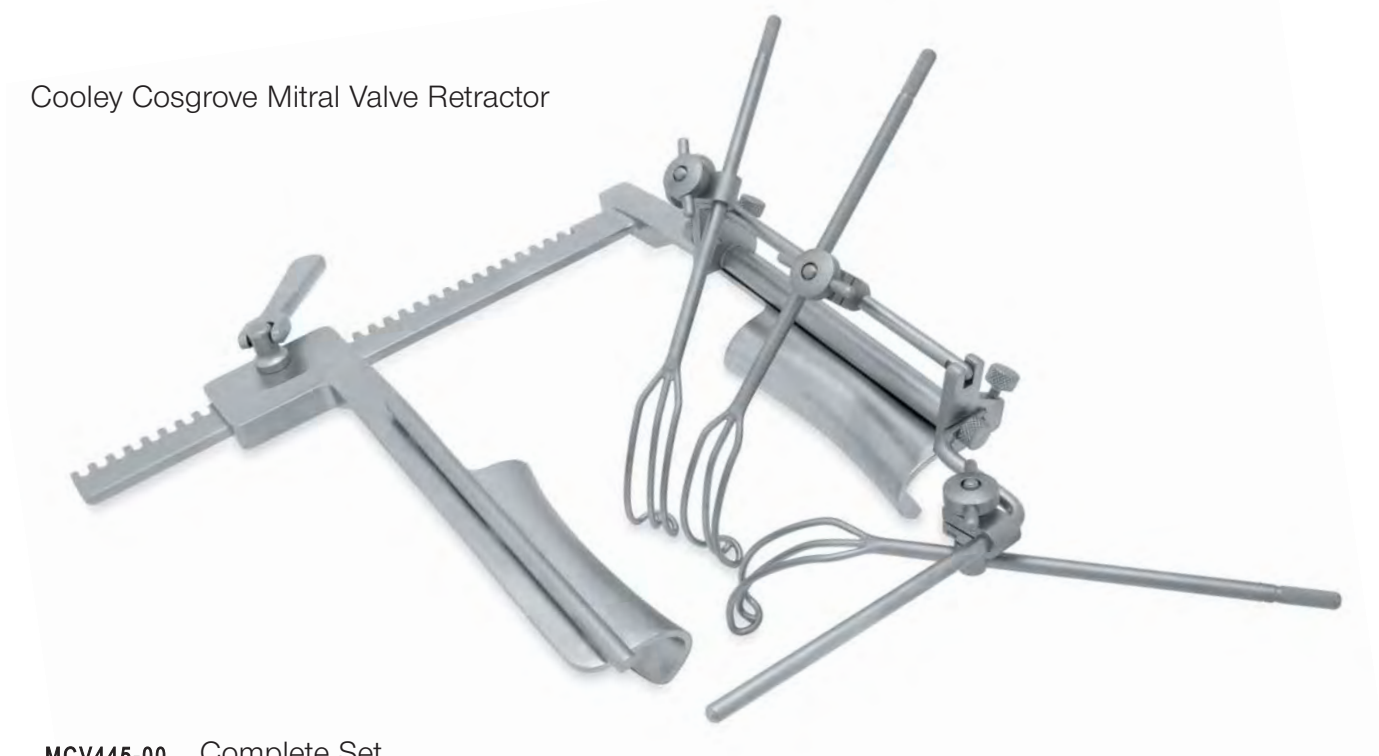

MCV445-00 Complete Set

- Consisting of:
- 1x Cooley Rib Spreader Adult Blades 40mm x 110mm with Cosgrove Mounting Bars
 - 1x Main Bracket Attachment
 - 3x Universal Clamps
 - 1x Side Arm Bar
 - 1x Tricuspid Retractor Blade
 - 1x Large Retractor Blade
 - 3x Small Retractor Blades



Retractor Blade Large **MCV448-01**

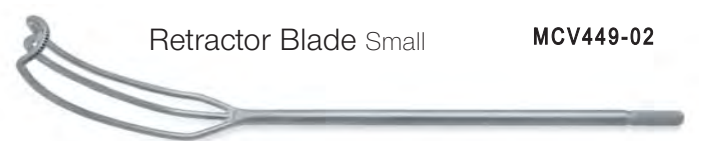

Retractor Blade Small **MCV449-02**



Tricuspid Retractor Blade **MCV450-03**



Universal Clamp
MCV446-06



Main Bracket Attachment **MCV447-05**



Side Arm Bar
MCV451-04

Abdominal Ring Retractor System

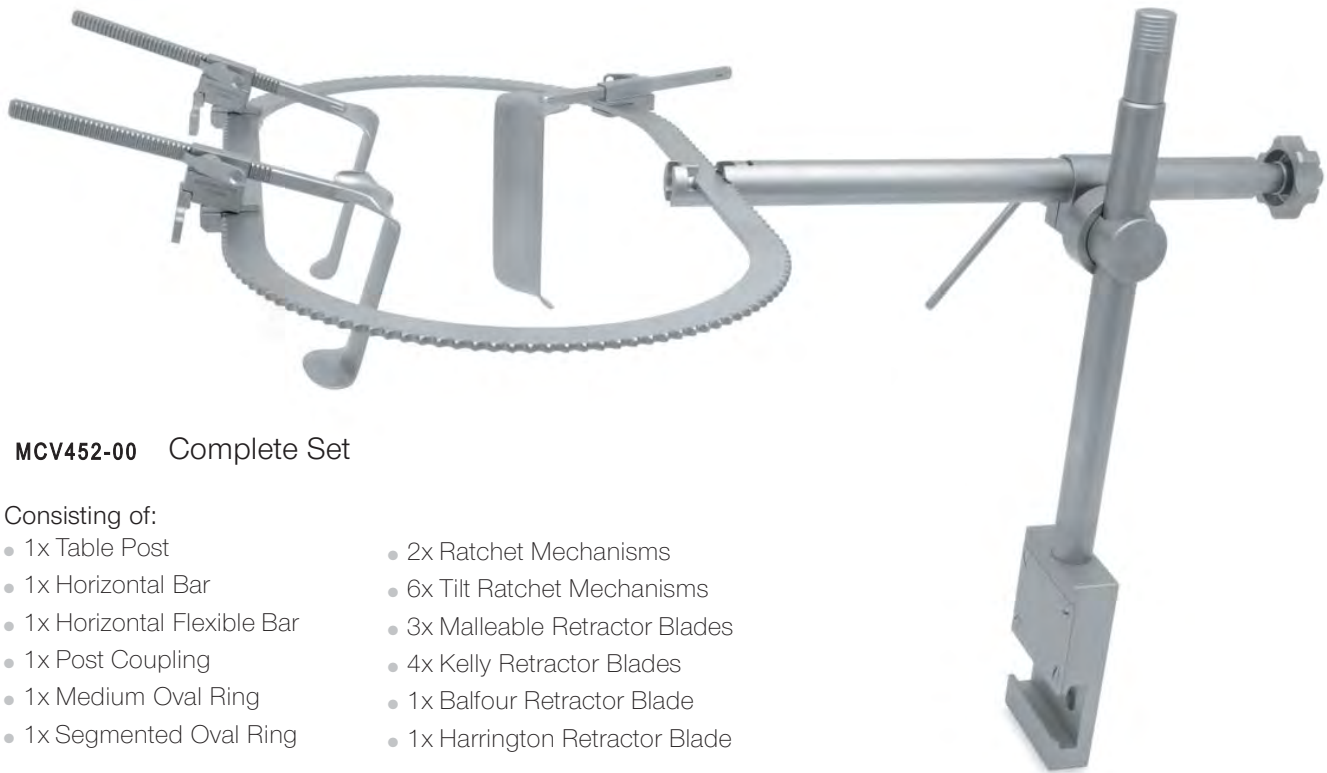

MCV452-00 Complete Set

Consisting of:

- 1x Table Post
- 1x Horizontal Bar
- 1x Horizontal Flexible Bar
- 1x Post Coupling
- 1x Medium Oval Ring
- 1x Segmented Oval Ring
- 2x Ratchet Mechanisms
- 6x Tilt Ratchet Mechanisms
- 3x Malleable Retractor Blades
- 4x Kelly Retractor Blades
- 1x Balfour Retractor Blade
- 1x Harrington Retractor Blade

Components:

Table Post

MCV453-00



Horizontal Bar

MCV454-00



Horizontal Flexible Bar

MCV455-00



Post Coupling

MCV456-00



Ratchet Mechanism

MCV457-00



Tilt Ratchet Mechanism

MCV458-00





ABDOMINAL RING RETRACTOR

Medium Oval Ring

MCV459-00



Segmented Oval Ring

MCV460-00



Malleable Retractor Blades

Code	Blade Size	
	width	depth
MCV461-01	38mm	152mm
MCV462-02	51mm	152mm
MCV463-03	76mm	152mm



Kelly Retractor Blades

Code	Blade Size	
	width	depth
MCV464-01	51mm	76mm
MCV465-02	51mm	102mm
MCV466-03	51mm	127mm
MCV467-04	51mm	154mm



Balfour Retractor Blade

Code	Blade Size	
	width	depth
MCV468-01	67mm	76mm



Harrington Retractor Blade

Code	Blade Size	
	width	depth
MCV469-01	63mm	143mm

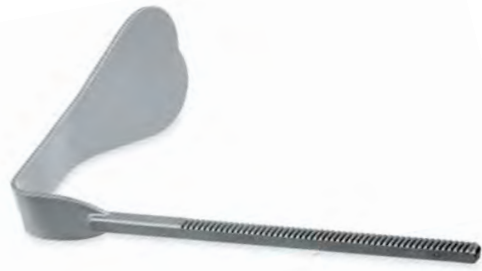

Jacobson Micro Vessel Probe

- 18.5cm/7¹/₄"
- Probe with ball tip



MCV470-18

Krayenbühl Nerve and Vessel Hook

- 18.5cm/7¹/₄"



MCV471-18



MCV472-18



MCV473-18



MCV474-18



Adson Dural Hook

- 19cm/7¹/₂"
- 2mm tip length

Sharp

MCV475-19

Blunt

MCV476-19



Cushing Blunt Hook

- 19cm/7¹/₂"
- 3mm tip length

MCV477-19



Crile Blunt Hook

- 20cm/8"
- 7mm tip length

MCV478-20



Adson Hook

- 20cm/8"
- 5mm tip length

Sharp

MCV479-20

Blunt

MCV480-20



Blalock Blunt Hook

- 24cm/9¹/₂"
- 5mm tip length

MCV481-24



RETRACTORS & HOOKS

Gillies Skin Hook

- 18cm/7"

MCV482-01 Small size
MCV483-02 Large size



Klienert-Kutz Skin Hook

- 16cm/6¹/₄"

MCV484-01



Ragnell-Davies Retractor

- 14cm/5¹/₂"

MCV485-14



Mini-Langenbeck Retractor

- 16cm/6¹/₄"

MCV486-10 10 x 6mm *illustrated
MCV487-17 17 x 5mm



Desmarres Saddle Retractor

- 16cm/6¹/₄"
- 12mm width

MCV488-12



Senn-Miller Double Ended Catspaw Retractor

- 16cm/6¹/₄"

MCV489-01 Sharp prongs
MCV490-02 Blunt prongs



Kilner-Miniature Pattern Catspaw Retractor

- 15cm/6"

MCV491-01



Langenbeck Retractor

• 21.5cm/8¹/₂"



Code	Blade Size		
	depth	width	
MCV492-21	22mm x 6mm		Small
MCV493-21	45mm x 13mm		Medium
MCV494-21	65mm x 25mm		Large
MCV495-21	90mm x 20mm		X-large

Morris Retractor

• 25cm/9³/₄"



Code	Blade Size	
	depth	width
MCV496-40	50mm x 40mm	
MCV497-50	50mm x 50mm	
MCV498-65	50mm x 65mm	
MCV499-40	70mm x 40mm	
MCV500-50	70mm x 50mm	
MCV501-65	70mm x 65mm	

Deavers Abdominal Retractor

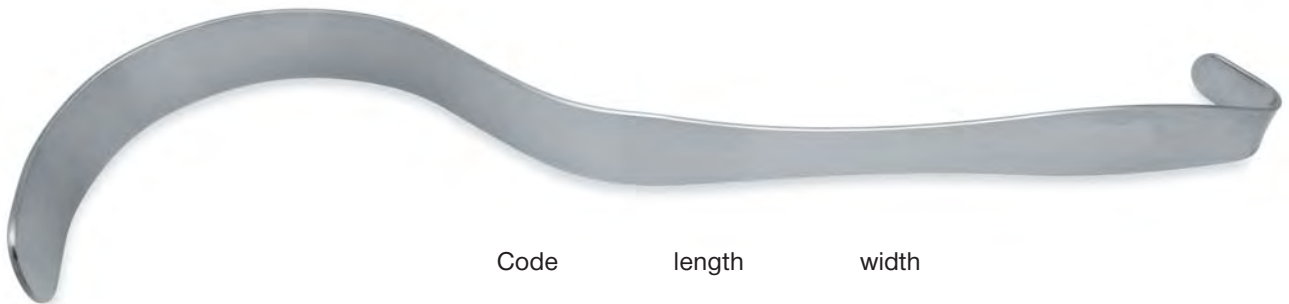

Code	length	width
MCV502-25	300mm	25mm
MCV503-30	350mm	25mm
MCV504-38	300mm	38mm
MCV505-50	300mm	50mm
MCV506-75	300mm	75mm



RETRACTORS

Tudor Edwards Scapula Retractor

- 20cm/8"
- Toothed blade 50mm x 45mm

MCV507-20



Brompton Erector Spinae Retractor

- Hollow handle
- 20cm/8"
- 2 Prong blades

MCV508-20



Brock Erector Spinae Retractor

- Hollow handle
- 20cm/8"

MCV509-20



Allison Lung Retractor



Code		length
MCV510-28	Infant	28cm
MCV511-28	Child	28cm
MCV512-30	Adult	30cm

Ross Aortic Retractor

- 26cm/10½"



Code	width	Code	width
MCV513-10	No.1	MCV516-40	No.4
MCV514-20	No.2	MCV517-50	No.5
MCV515-30	No.3	MCV518-60	No.6

Baby Weitlaner S/R Retractor

- 2 x 3 Blunt Prongs
- 11.5cm/4½"

MCV519-10



West's S/R Retractor

- 3 x 4 Sharp Prongs
- 14cm/5½"

MCV520-14



Travers S/R Retractor

- 4 x 5 Blunt Prongs
- 20cm/8"

MCV521-20



Norfolk and Norwich S/R Retractor

- 4 x 5 Blunt Prongs
- 20cm/8"

MCV522-20



RIB RASPATORY

Doyen Periosteal Elevator - Right

MCV523-15 Child - 15cm length

MCV524-16 Adult - 16.5cm length



Doyen Periosteal Elevator - Left

MCV525-15 Child - 15cm length

MCV526-16 Adult - 16.5cm length



Price Thomas Rib Raspatory

MCV527-12 12mm width

MCV528-20 20mm width



Semb Rib Raspatory



No.1
short shaft,
notched
end for rib
edge,
200mm

MCV529-20



No.2
long shaft,
notched
end for rib
edge,
235mm

MCV530-23



No.3
short shaft,
straight
end,
190mm

MCV531-19



No.4
long shaft,
straight
end,
250mm

MCV532-25



No.5
short shaft,
oval blade,
220mm

MCV533-22



No.6
short shaft,
angled oval
end for back
of first rib,
195mm

MCV534-19



No.7
long shaft,
for edge of
first rib,
250mm

MCV535-25



No.8
chisel end for
disarticulation
of costo
vertebral joint,
200mm

MCV536-20

Stille-Liston Bone Cutters

- Double Action
- Straight
- 27cm/10³/₄"

MCV537-27

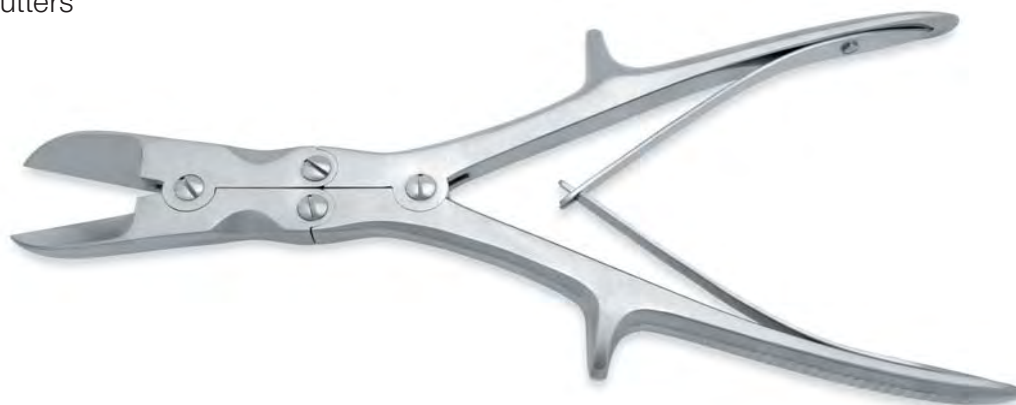

Liston-Key-Horsley Bone Cutters

- Double Action
- Angled
- 27cm/10³/₄"

MCV538-27



Tudor Edwards/Vehmehren Costotome

- 24cm/9¹/₂"
- For Cutting Ribs

MCV539-24





WIRE CUTTERS

Muller Claus Wire Cutters

- 16cm/6"
 - Tungsten Carbide Edges
 - Cuts wire up to 16mm Ø
- MCV540-16**



Muller Claus Wire Cutters

- Tungsten Carbide Edges
 - 18cm/7" length (*illustrated)
 - Cuts wire up to 2mm Ø
- MCV541-18**



- 22cm/8³/₄" length
 - Cuts wire up to 3mm Ø
- MCV542-22**

End Wire Cutters

- 18cm/7" length
 - Tungsten Carbide Edges
 - Cuts wire up to 17mm Ø
- MCV543-18**



Muller Claus Wire Pullers

- 18cm/7" length

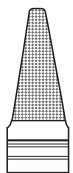

2mm Jaws
MCV544-18

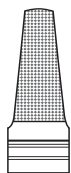

4mm Jaws
MCV545-18



6mm Jaws
MCV546-18



MacDonalds Dissector

- 19cm/7½"



MCV547-19

Watson Cheyne Dissector

MCV548-12 12.5cm/5"

MCV549-18 18cm/7"



Freer Dissector

- 19cm/7½"



MCV550-18

MICRO CLAMPS

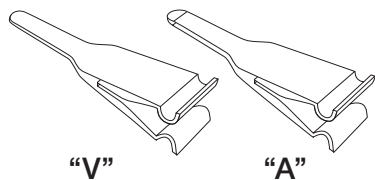

“A” or “V” Pattern?

Throughout the series, the “V” pattern is the all-purpose clamp, commonly used on all veins, and almost all arteries. The “A” pattern, available in all sizes, is designed for exceptionally thick-walled vessels and slippery arteries. The slight incurve of the tips of the “A” pattern jaw provides extra security against slippage.

- Light and compact design
- Extremely durable
- A unique gripping surface
- Smooth sliding bar action on all approximator clamps
- Clamp profile with parallel sided jaws
- Matt or black finish

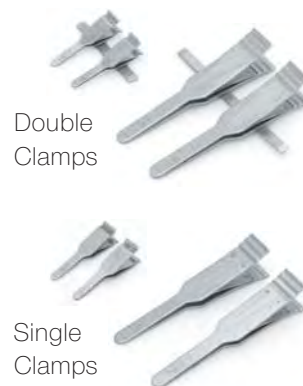

Ordering details

SINGLE CLAMPS

MCV551-396 V
MCV552-397 A



CLAMP SIZE
B-1
0.4 - 1.0mm

MCV553-398 V
MCV554-399 A



B-2
0.6 - 1.5mm

MCV555-400 V
MCV556-401 A



B-3
1.0 - 2.25mm

MCV557-325



HD-S
1.5 - 3.5mm

MCV558-286



RD-S
2.0 - 5.0mm

DOUBLE APPROXIMATING CLAMPS

MCV559-414 V
MCV560-415 A



CLAMP SIZE
ABB - 11
0.4 - 1.0mm

MCV561-416 V
MCV562-417 A



ABB - 22
0.6 - 1.5mm

MCV563-418 V
MCV564-419 A



ABB - 33
1.0 - 2.25mm

MCV565-326

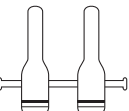
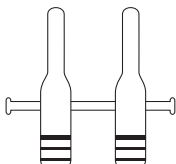

HD-D
1.5 - 3.5mm

MCV566-287

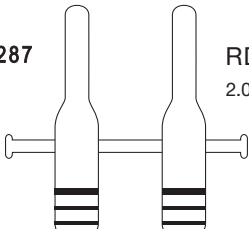

RD-D
2.0 - 5.0mm

DOUBLE CLAMPS WITH FRAME

MCV567-408 V
MCV568-409 A



CLAMP SIZE
ABB-1
0.4 - 1.0mm

MCV569-410 V
MCV570-411 A



ABB-2
0.6 - 1.5mm

MCV571-412 V
MCV572-413 A



ABB-3
1.0 - 2.25mm

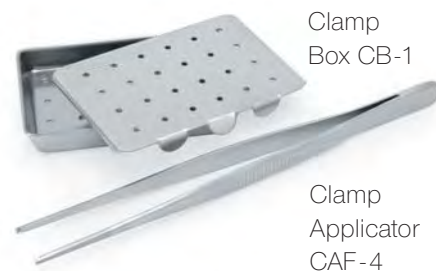

Diethrich Mini Bulldog Clamps

- Straight
- Weight 3gr
- Closing pressure 80gr



Overall length
Jaw length
Code

50mm
8mm

MCV573-50



55mm
12mm

MCV574-55



60mm
16mm

MCV575-60



65mm
20mm

MCV576-65

Diethrich Mini Bulldog Clamps

- Angled
- Weight 3gr
- Closing pressure 80gr



Overall length
Jaw length
Code

43mm
8mm

MCV577-43

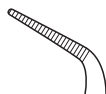

45mm
12mm

MCV578-45

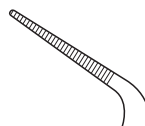

50mm
16mm

MCV579-50

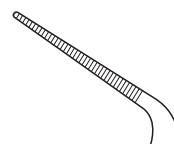

55mm
20mm

MCV580-55

BULLDOG CLAMPS

DeBakey-Diethrich Mini Bulldog Clamps

- Straight
- Weight 3gr
- Closing pressure 180gr



Overall length
Jaw length
Code

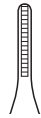

47mm
10mm

MCV581-47

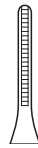

51mm
14mm

MCV582-51

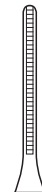

57mm
20mm

MCV583-57

DeBakey-Diethrich Mini Bulldog Clamps

- Angled
- Weight 3gr
- Closing pressure 180gr



Overall length
Jaw length
Code



44mm
10mm

MCV584-44

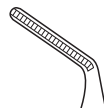

46mm
14mm

MCV585-46

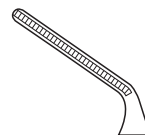

49mm
20mm





MCV586-49

Low Closing Pressure for Veins 110gr marked with V
 High Closing Pressure for Arteries 220gr marked with A

Titanium Mini Glover Bulldog Clamps

- Straight
- Weight 0.8gr







				
Overall length	30mm	35mm	40mm	50mm
Jaw length	11mm	15mm	17mm	24mm
Vein	MCV587-30T	MCV588-35T	MCV589-40T	MCV590-50T
Low Closing Pressure				
Arterial	MCV591-30T	MCV592-35T	MCV593-40T	MCV594-50T
High Closing Pressure				

Titanium Mini Glover Bulldog Clamps

- Curved
- Weight 0.8gr







				
Overall length	30mm	35mm	40mm	50mm
Jaw length	11mm	15mm	17mm	24mm
Vein	MCV595-30T	MCV596-35T	MCV597-40T	MCV598-50T
Low Closing Pressure				
Arterial	MCV599-30T	MCV600-35T	MCV601-40T	MCV602-50T
High Closing Pressure				

Titanium Mini Glover Bulldog Clamps

- Strongly Curved
- Weight 0.8gr



				
Overall length	30mm	35mm	40mm	50mm
Jaw length	11mm	15mm	17mm	24mm
Vein	MCV603-30T	MCV604-35T	MCV605-40T	MCV606-50T
Low Closing Pressure				
Arterial	MCV607-30T	MCV608-35T	MCV609-40T	MCV610-50T
High Closing Pressure				





BULLDOG CLAMPS

Glover Bulldog Clamps

- Straight
- Closing Pressure adjustable

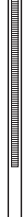
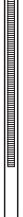



				
Overall length	50mm	68mm	85mm	105mm
Jaw length	20mm	30mm	43mm	56mm
Code	MCV611-50	MCV612-68	MCV613-85	MCV614-05

Glover Bulldog Clamps

- Curved
- Closing Pressure adjustable



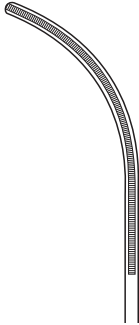
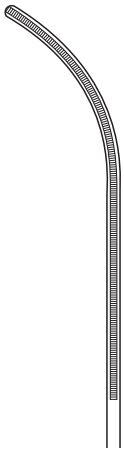



				
Overall length	46mm	64mm	78mm	100mm
Jaw length	20mm	30mm	43mm	56mm
Code	MCV615-50	MCV616-68	MCV617-85	MCV618-05

Mini-Glover Bulldog Clamps

- Weight 12g



				
Overall length	35mm	35mm	35mm	35mm
Jaw length	14mm	14mm	14mm	14mm
Code	MCV619-35	MCV620-35	MCV621-35	MCV622-35

Glover Bulldog Clamps

- Angled
- 55mm length Jaws

MCV623-55



DeBakey-Satinsky Bulldog Clamps

- Curved
- 55mm length Jaws

MCV624-55



DeBakey Carotid Bulldog Clamps

- Curved
- 90mm length Jaws

MCV625-90



DeBakey-Satinsky Bulldog Clamps

- Curved
- 100mm length Jaws

MCV626-10





BULLDOG CLAMPS

Gregory 'Soft' Carotid Bulldog Clamps

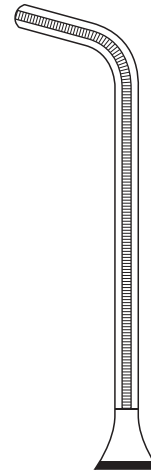
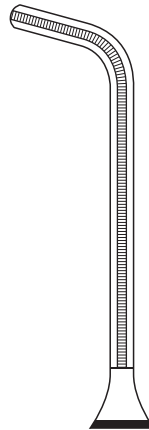
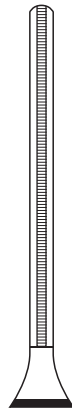
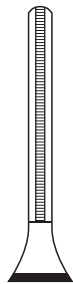

Overall length
Jaw length
Code

90mm
27mm
MCV627-90

110mm
44mm
MCV628-11

105mm
55mm
MCV629-10

110mm
60mm
MCV630-11

Modified Gregory 'Soft' Bulldog Clamps

- Curved
- Weight 12g

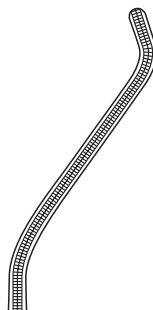
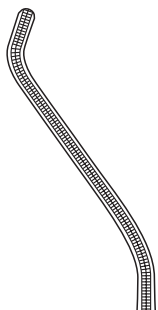

Overall length
Jaw length
Code

110mm
60mm
MCV631-11

110mm
60mm
MCV632-11

curved to left

curved to right

DeBaKey Bulldog Clamps

- Straight

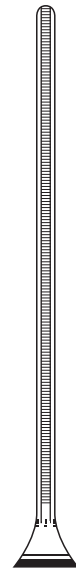
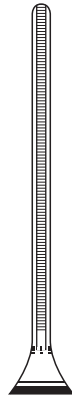
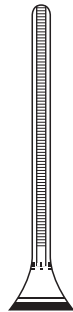
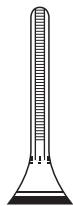

Overall length
Jaw length

80mm
20mm

90mm
30mm

105mm
45mm

125mm
68mm

Code

MCV633-08

MCV634-09

MCV635-10

MCV636-12

DeBaKey Bulldog Clamps

- Curved

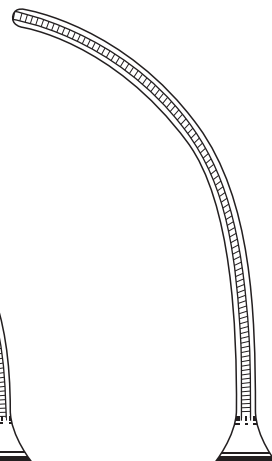
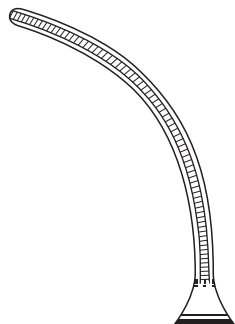
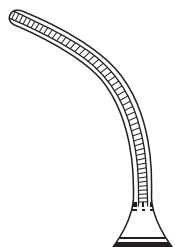
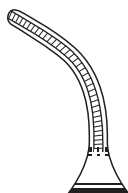

Overall length
Jaw length

75mm
20mm

85mm
30mm

95mm
45mm

115mm
68mm

Code

MCV637-08

MCV638-09

MCV639-10

MCV640-12

VASCULAR CLAMPS

DeBakey Castaneda Paediatric Clamp

- Curved shanks
- Suitable for Paediatric and delicate surgery
- 12cm/5" length

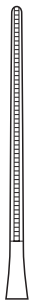

MCV641-12

Straight

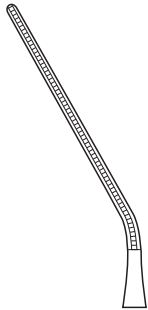

MCV642-12

Angled 25°

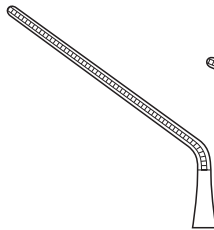

MCV643-12

Angled 45°

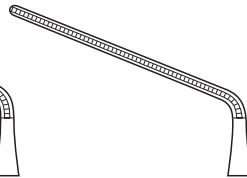

MCV644-12

Angled 60°

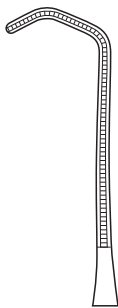

MCV645-12

Anastomosis

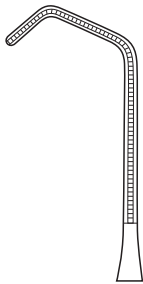

MCV646-12

Anastomosis

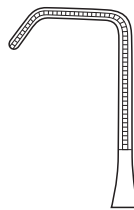

MCV647-12

omosis 90°

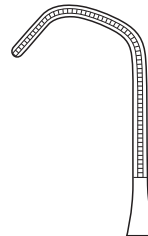

MCV648-12 *

Satinsky

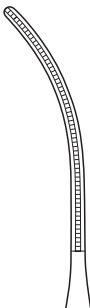

MCV649-12

Light curve



MCV650-12

Spoon shaped

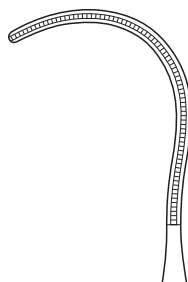

MCV651-12

Strong curve

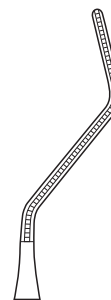

MCV652-12

Carotid



DeBakey Ring Handled Bulldog Clamp

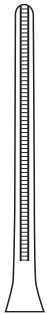

MCV653-12 straight
12.5cm/5"

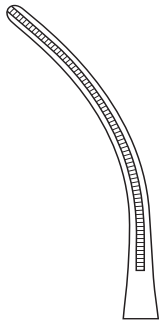

MCV654-12 curved
12.5cm/5"

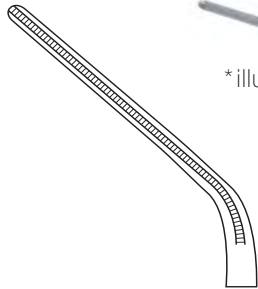

MCV655-12 *angled 45°
12.5cm/5"

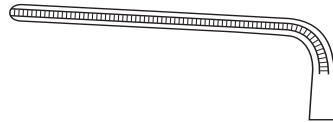

MCV656-12 angled 90°
10cm/4"



*illustrated

DeBakey-Glover Anastomosis Clamp

- Straight shanks

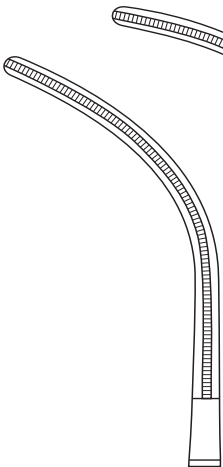
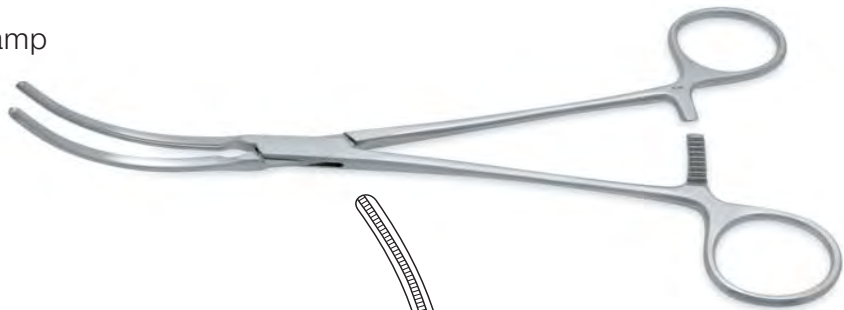

MCV657-21
21cm/8 1/4"

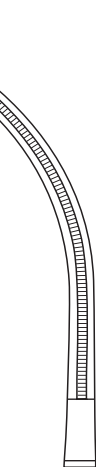

MCV658-24
24cm/9 1/2"

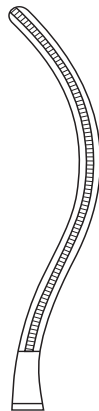

MCV659-21
21cm/8 1/4"

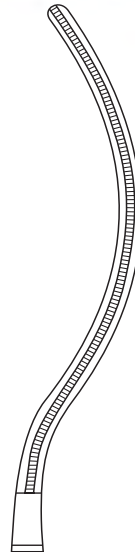

MCV660-26
26cm/10 1/4"

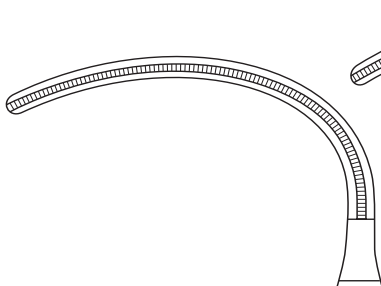

MCV661-18
18.5cm/7 1/4"

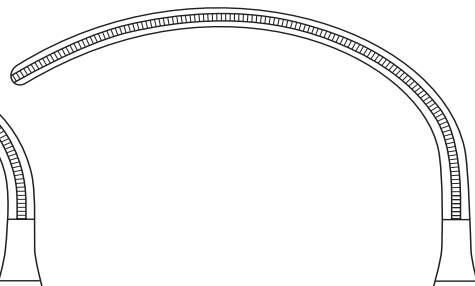

MCV662-22
22cm/8 3/4"

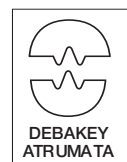



VASCULAR CLAMPS

Lambert-Kay Aortic Clamp

- 20cm/8" length

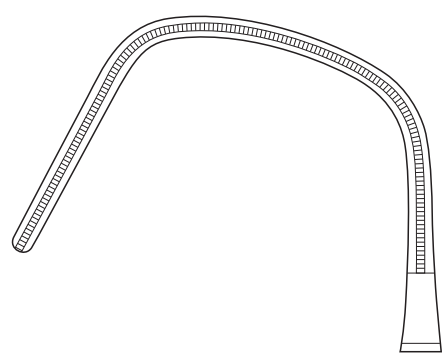

MCV663-20

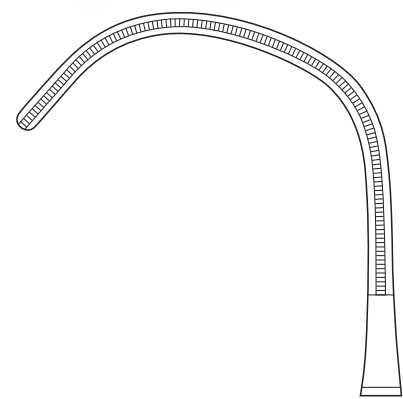

MCV664-21



Weber Aortic Clamp

- 26cm/10 1/4" length

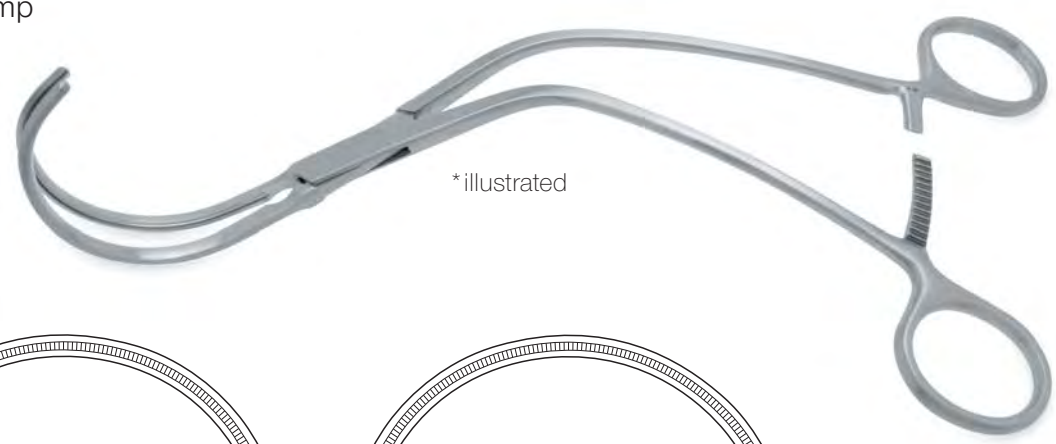

* illustrated

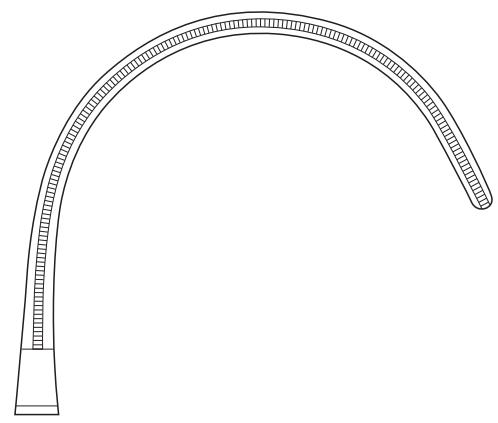

MCV665-26 * Left curved

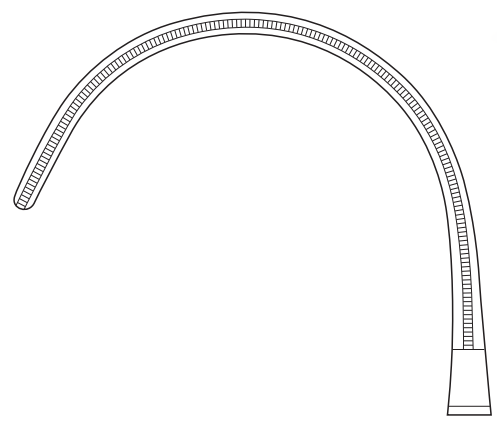

MCV666-26 Right curved



DeBakey Aortic Aneurism Clamp

- Curved Shanks



24cm/9 $\frac{1}{2}$ "
MCV667-24

27cm/10 $\frac{1}{4}$ "
MCV668-27

31cm/12 $\frac{1}{4}$ "
MCV669-31

33cm/13"
MCV670-33

DeBakey-Bahnson Aortic Aneurism Clamp

- S-Shape Shanks

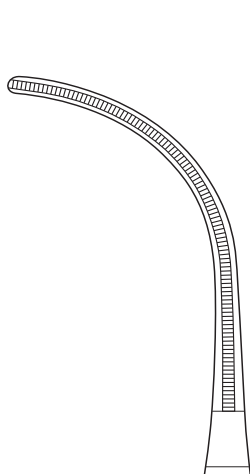

24.5cm/9 $\frac{3}{4}$ "
MCV671-24

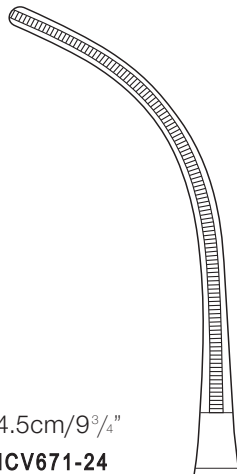

25.5cm/10"
MCV672-25

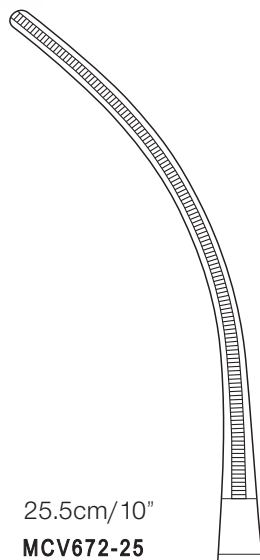

26.5cm/10 $\frac{1}{2}$ "
MCV673-26





VASCULAR CLAMPS

DeBakey Glover Patent Ductus Clamp

- Straight Shanks

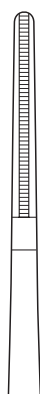

20cm/8"
MCV674-20

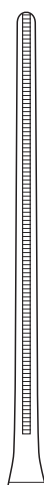

22cm/8³/₄"
MCV675-22

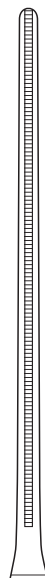

26cm/10¹/₄"
MCV676-26



DeBakey Glover Patent Ductus Clamp

- Angled Shanks

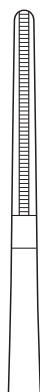

20cm/8"
MCV677-20

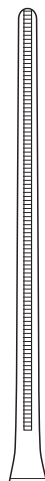

22cm/8³/₄"
MCV678-22

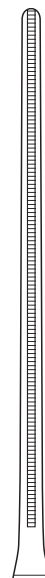

26cm/10¹/₄"
MCV679-26



DeBakey Peripheral Clamp



*illustrated

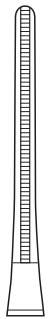

Straight Shanks *
19.5cm/7³/₄"
MCV680-19

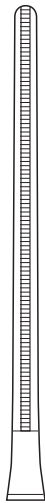

Straight Shanks
22cm/8³/₄"
MCV681-22

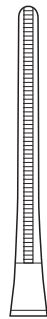

Angled Shanks
19.5cm/7³/₄"
MCV682-19



Angled Shanks
22cm/8³/₄"
MCV683-22



DeBakey Peripheral Clamp

- Curved Shanks
- Angled 45°

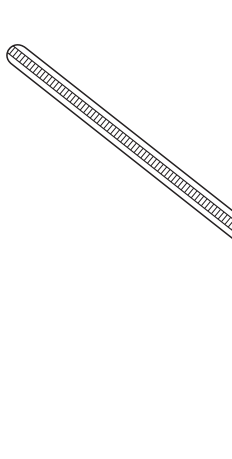

19cm/7¹/₂"
MCV684-19

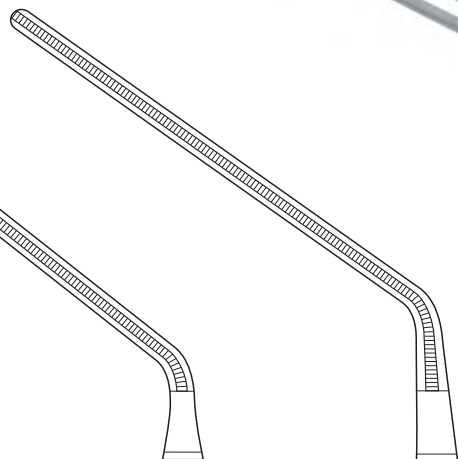

26cm/8¹/₂"
MCV685-26

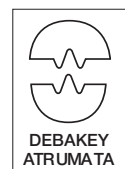



VASCULAR CLAMPS

DeBakey Peripheral Clamp

- S-Shaped

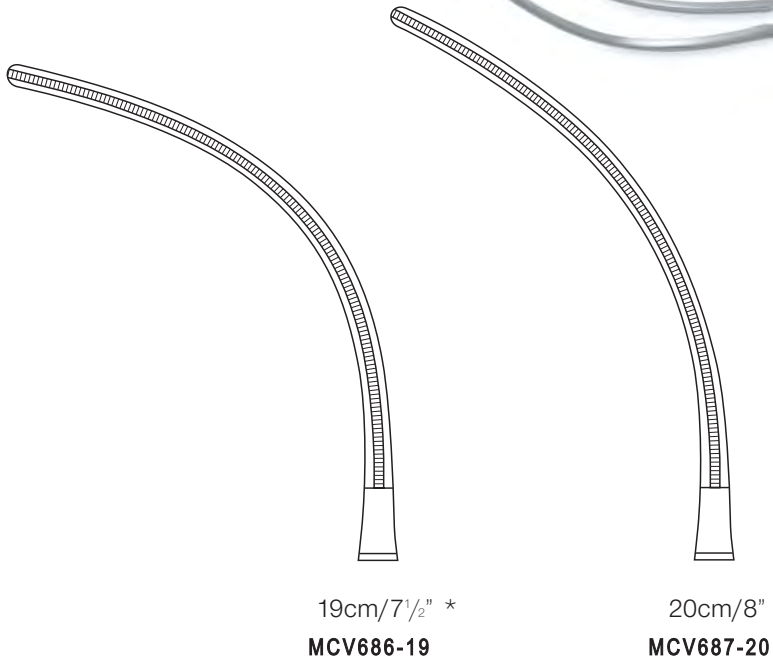

* illustrated



Leland-Jones Peripheral Vascular Clamp

- Straight Shanks

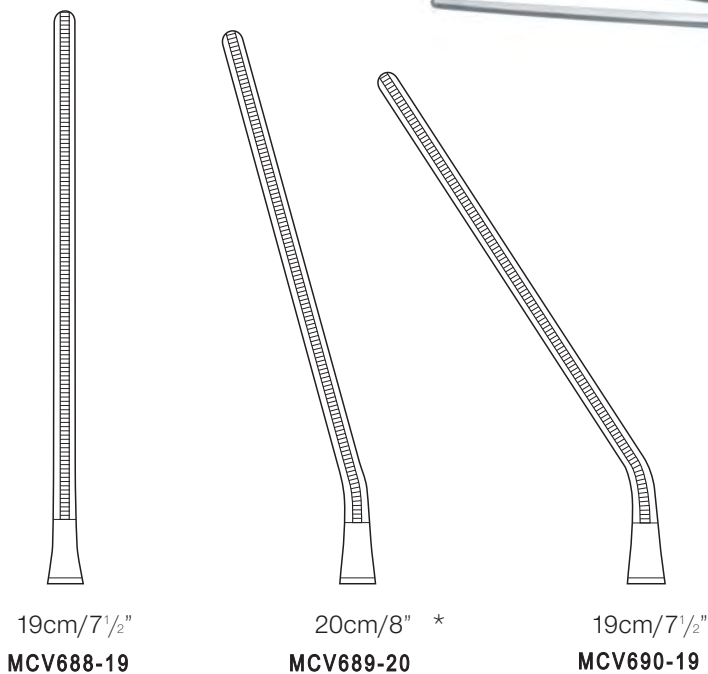

* illustrated

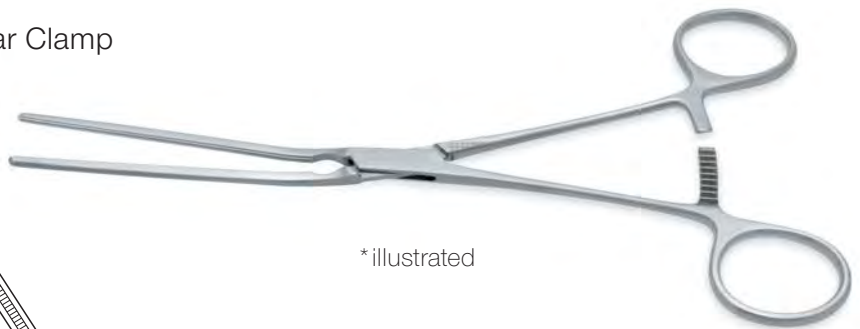

DeBakey Multi-Purpose Clamp

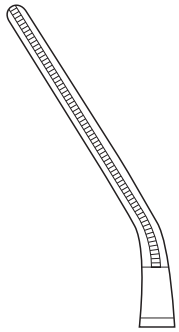

MCV691-16 *
16cm/6 1/4"
30° Angled Jaws

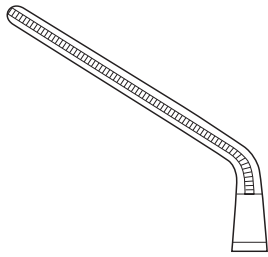

MCV692-15
15.5cm/6"
60° Angled Jaws

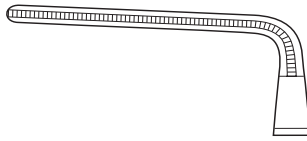

MCV693-14
14.5cm/6 1/2"
90° Angled Jaws

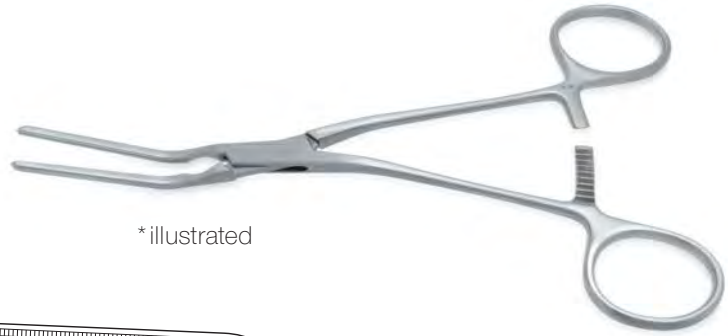

* illustrated

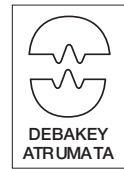

DeBakey Multi-Purpose Forceps

- Angled 60°
- Curved Shanks

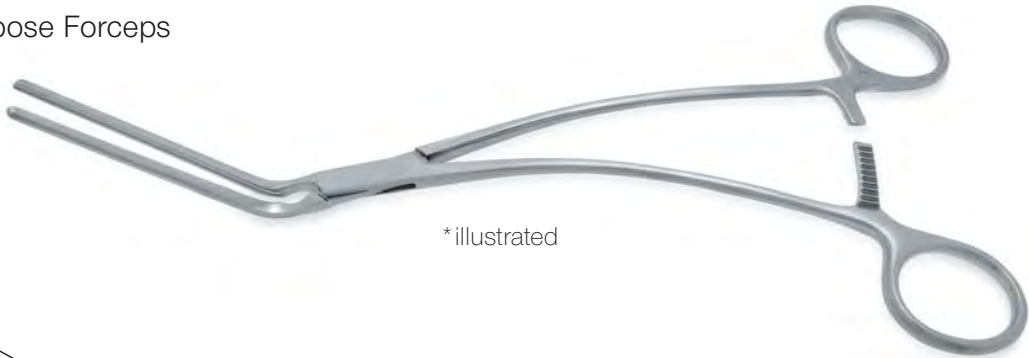

* illustrated

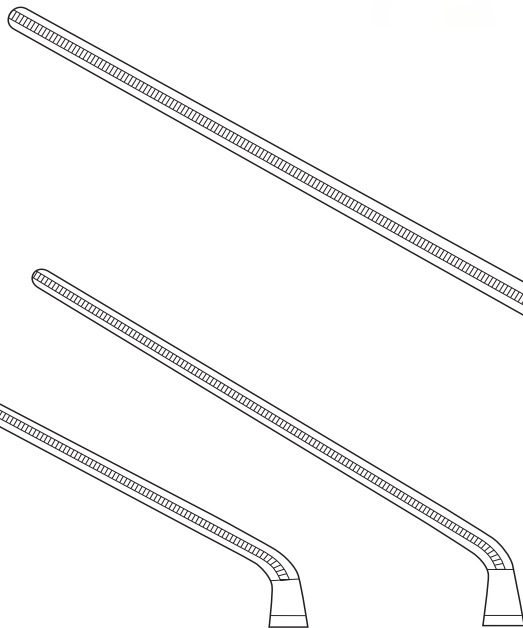

MCV694-20
20cm/8"

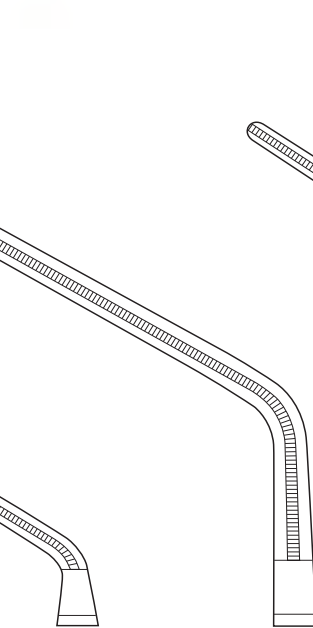

MCV695-24 *
24cm/9 1/2"

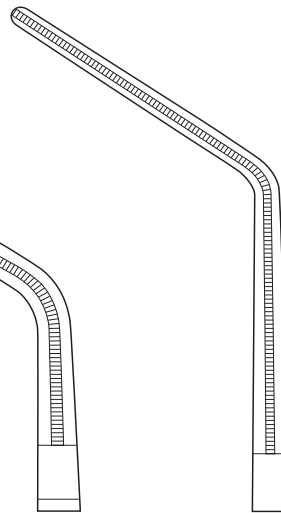

MCV696-30
30cm/12"

MCV697-25
25cm/10"

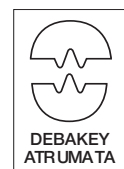



VASCULAR CLAMPS

DeBakey Multi-Purpose Clamp

- Angled 90°



* illustrated

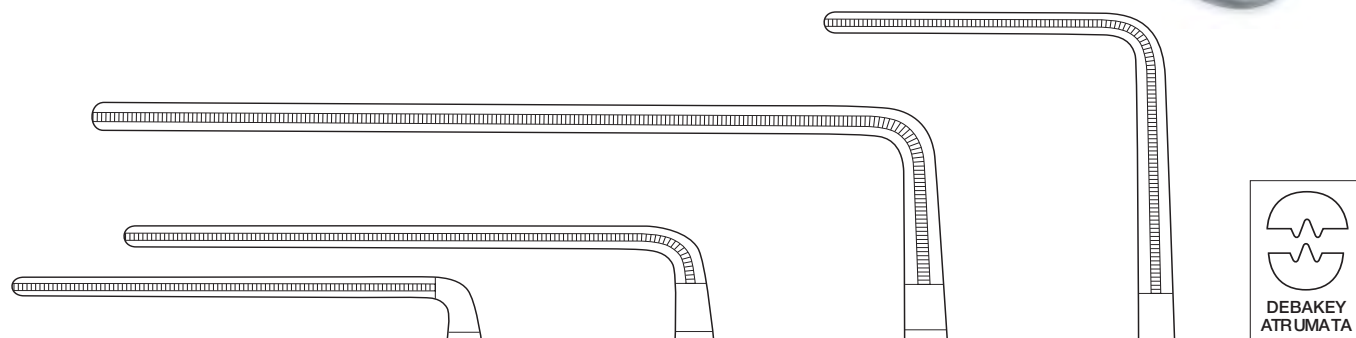

MCV698-18

18cm/7"

MCV699-21 *

21.5cm/8½"

MCV700-27

27.5cm/10¾"

MCV701-23

23cm/9"

DeBakey-Beck Paediatric Aortic Forceps

- Straight Shanks

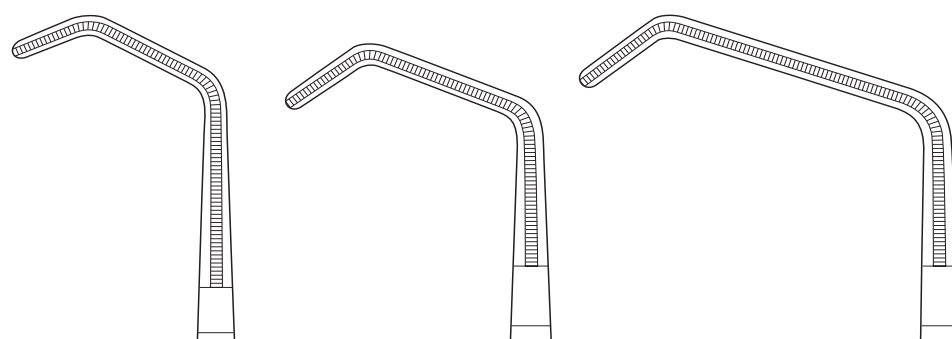

MCV702-16

16.5cm/6½"
Small

MCV703-19 *

19.5cm/7¾"
Medium

MCV704-20

20.5cm/8"
Large

DeBakey Tangential Occlusion Clamp

- Curved Shanks

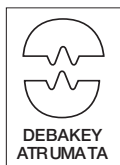
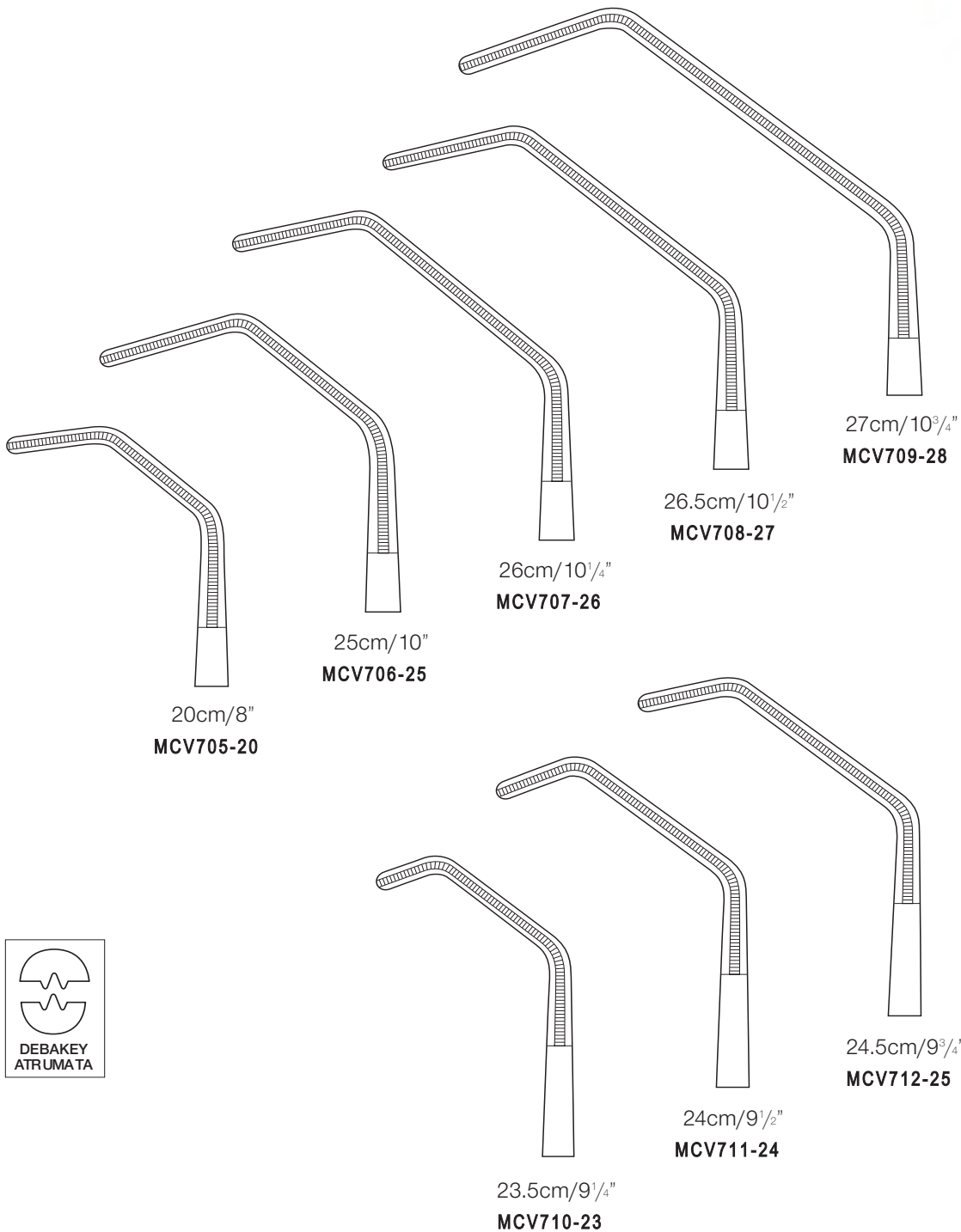
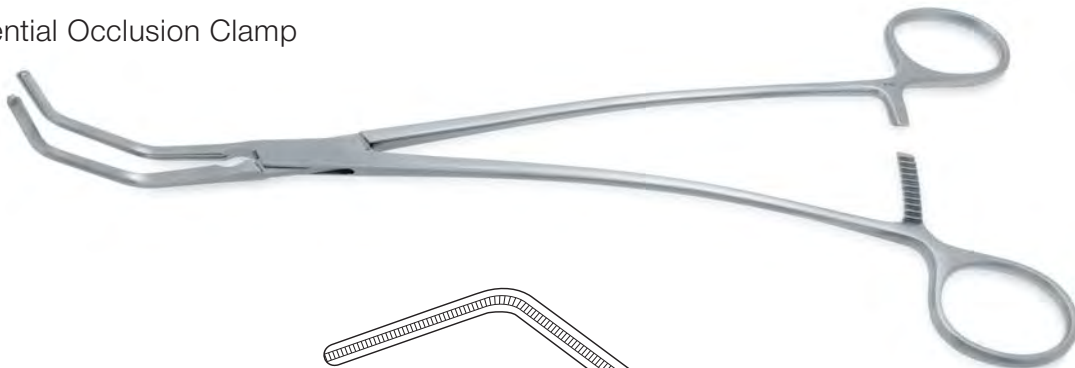



VASCULAR CLAMPS

DeBakey Anastomosis Clamp

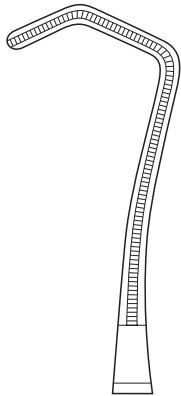

17cm/6³/₄"
MCV713-17



DeBakey-Derra Anastomosis Clamp

- 17cm/6³/₄" length

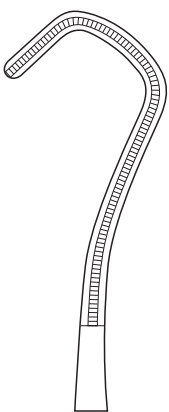

MCV714-17

Small

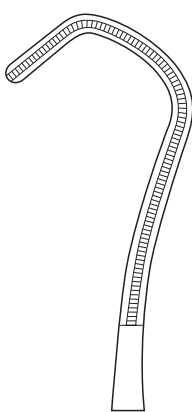

MCV715-17

Medium

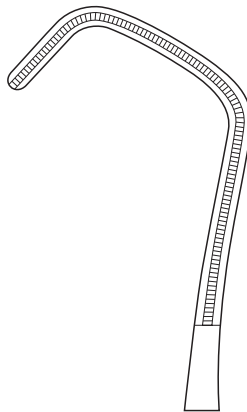

MCV716-17

Large



DeBakey-Reynolds Anastomosis Clamp

- Angled Shanks

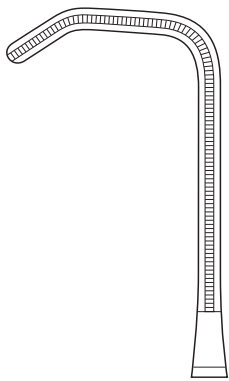

MCV717-16

16.5cm/6½"

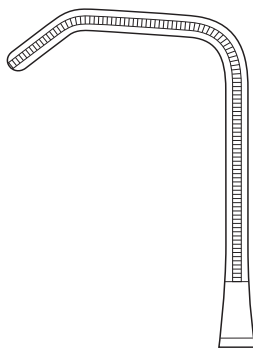

MCV718-16

16.5cm/6½"

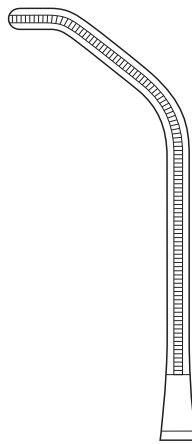

MCV719-18

18cm/7"

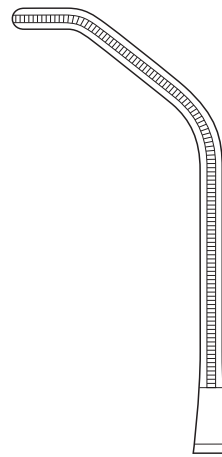

MCV720-18

18cm/7"

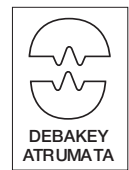

DeBakey Curved Anastomosis Forceps

- 17cm/6¾" length
- Curved Shanks

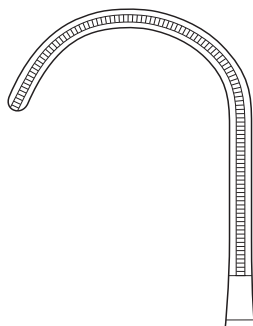

MCV721-17

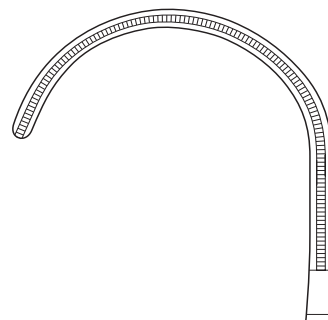

MCV722-17



VASCULAR CLAMPS

DeBakey-Semb Ligature Carrier

• 25cm/10" length

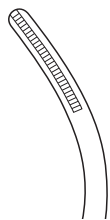

MCV723-25

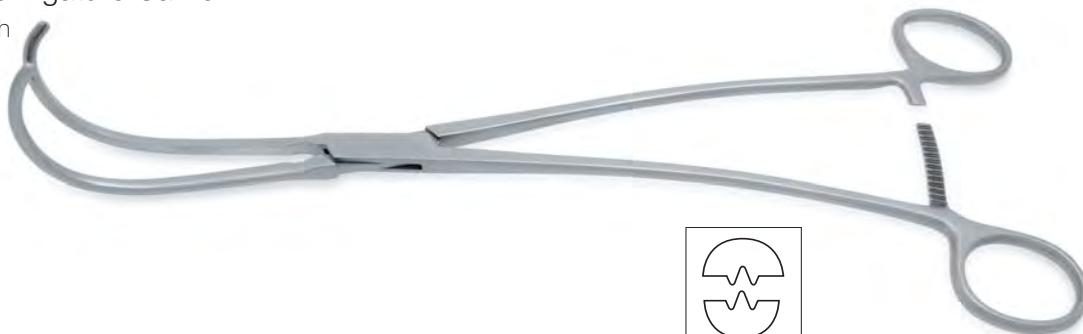

DeBakey Ligature Forceps

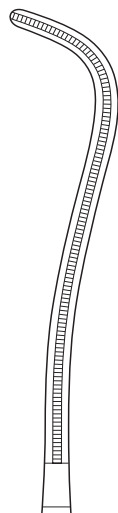

MCV724-19

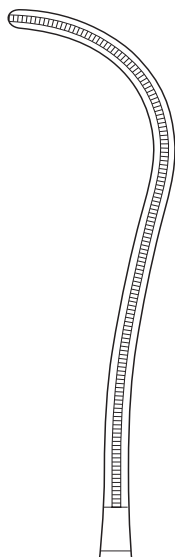

MCV725-19



Semb Ligature Forceps

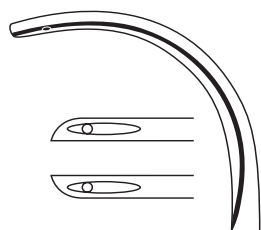

MCV726-23



MCV727-24



Cooley-Derra Anastomosis Clamp

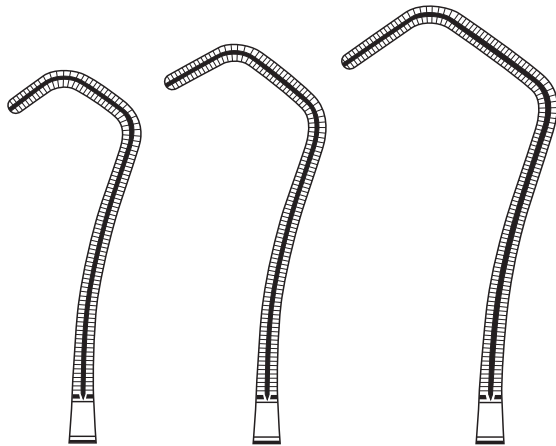

MCV728-16

small
16.5cm/6½"

MCV729-17

medium
17cm/6¾"

MCV730-17

large
17.5cm/7"



Cooley-Beck Vascular Clamp

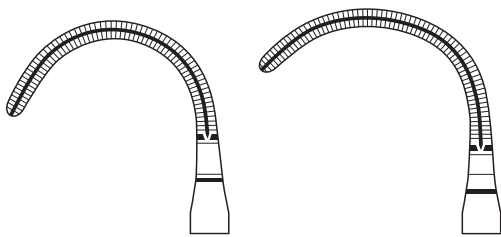

MCV731-15

15cm/6"

MCV732-15

15cm/6"



Cooley Coarctation Clamp

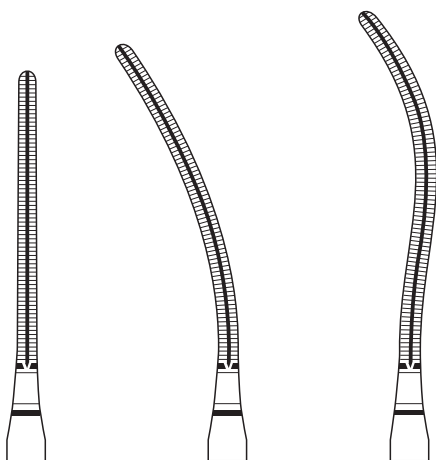

MCV733-17

MCV734-17

MCV735-18

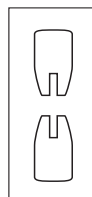

VASCULAR CLAMPS

Javid Carotid Clamp

- Small size
- 15cm/6" length

MCV736-15



For holding the shunt tube during Carotid Surgery

Javid Carotid Clamp

- Large size
- 18cm/7" length

MCV737-18



Dardik Multi-Purpose Clamp

Jaw Angle 15cm/6" length 17cm/6³/₄" length

0°	MCV738-00	MCV739-00
15°	MCV740-15	MCV741-15
30°	MCV742-30	MCV743-30
45°	MCV744-45	MCV745-45
90°	MCV746-90	MCV747-90

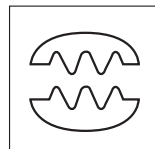
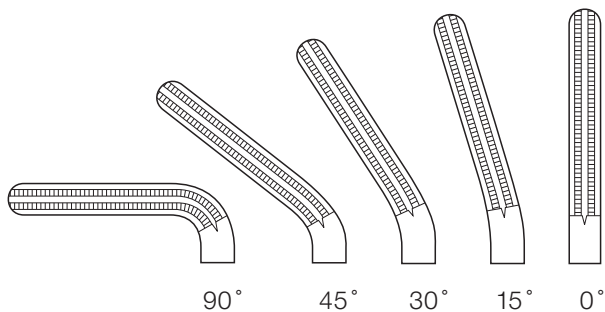

Frazier Suction Tube

- Angled 30°

diameter Ø	Overall Length	
	17cm/6½"	23cm/9"
2.0mm 6FG	MCV748-17	MCV749-23
2.3mm 7FG	MCV750-17	MCV751-23
2.7mm 8FG	MCV752-17	MCV753-23
3.0mm 9FG	MCV754-17	MCV755-23
3.3mm 10FG	MCV756-17	MCV757-23
3.7mm 11FG	MCV758-17	MCV759-23
4.0mm 12FG	MCV760-17	MCV761-23



American Pattern Suction Tube

- 16.5cm/6½" length
- MCV762-16**



Brompton Hospital Suction Tube

- 30cm/11¾" length



MCV763-30 Adult size for 9.5mm/⅜" tubing

MCV764-30 Child size for 6mm/¼" tubing

Brompton Hospital Suction Tube

- Paediatric 4.8mm Ø Tip size
- 23cm/9" length
- For 6.5mm/¼" tubing

MCV765-23



Southampton Western Hospital Suction Tube

- 22cm/8½" length
- Paediatric 3.3mm/⅛" Ø
- For 6.5mm/¼" tubing

MCV766-22



SUCTION TUBES & CANNULA

Tibbs Arterial Cannula

- Long Pattern
- Luer lock

Set of 4 **MCV767-10**

Large Cone **MCV768-20**

Small Cone **MCV769-30**

Large Olive **MCV770-40**

Small Olive **MCV771-50**



Heparin Flushing Needle

- Luer lock

2mm Ø Tip **MCV772-20**

2.5mm Ø Tip **MCV773-25**

3mm Ø Tip **MCV774-30**



Magill Suction Tube

- 21cm/8¹/₄" length

3mm Ø Tip **MCV775-21**

3.5mm Ø Tip **MCV776-21**

4.0mm Ø Tip **MCV777-21**



Yankauer Sucti

- 30.5cm/12" leng

MCV778-30



Pooles Suction Tube

- 24cm/9¹/₂" length
- 10mm Ø

MCV779-24 Straight mount * illustrated

MCV780-24 Curved mount



Paediatric Pooles Suction Tube

- 15cm/6" length
- 6mm Ø

MCV781-15



Ross Atrial Basket



length	tubing size Ø	code
29mm	1/2"/12.7mm	MCV782-15
29mm	3/8"/9.5mm	MCV783-20
19mm	3/8"/9.5mm	MCV784-25
16mm	1/4"/6.3mm	MCV785-30

Ross Sump Sucker (screw apart)



	diameter	tubing size Ø	code
Adult	7.5mm	3/16"/5.0mm	MCV786-75
Child	6.5mm	3/16"/5.0mm	MCV787-65
Infant	5.0mm	1/8"/3.5mm	MCV788-50

Ross Ventricular Vent (screw apart)



	diameter	tubing size Ø	code
Adult	7.5mm	3/16"/5.0mm	MCV789-75
Child	6.5mm	3/16"/5.0mm	MCV790-65
Infant	5.0mm	1/8"/3.5mm	MCV791-50

Baylor Sump Sucker (screw apart)



outside diameter	45° angled	90° angled
4.0mm	MCV792-40	MCV793-40
5.0mm	MCV794-50	MCV795-50
6.0mm	MCV796-60	MCV797-60

Bentall Femoral Cannula

- Rolled edge to bevel



bore Ø	code	bore Ø	code
1.5mm	MCV798-15	4.5mm	MCV804-45
2.0mm	MCV799-20	5.0mm	MCV805-50
2.5mm	MCV800-25	5.5mm	MCV806-55
3.0mm	MCV801-30	6.0mm	MCV807-60
3.5mm	MCV802-35	6.5mm	MCV808-65
4.0mm	MCV803-40	7.0mm	MCV809-70

Iliac Cannula

- Angled



bore Ø	code	bore Ø	code
2.5mm	MCV810-25	4.5mm	MCV814-45
3.0mm	MCV811-30	5.0mm	MCV815-50
3.5mm	MCV812-35	5.5mm	MCV816-55
4.0mm	MCV813-40	6.0mm	MCV817-60

JS Venous Cannula

- Cage tip
- 80° angled
- Long tubing end



bore Ø	code	bore Ø	code
3mm	MCV818-30	6mm	MCV821-60
4mm	MCV819-40	7mm	MCV822-70
5mm	MCV820-50	8mm	MCV823-80

VESSEL DILATORS & PROBES

Ross Coronary Artery Probe

- Same thickness along length of shaft

diameter Ø	10cm length	15cm length
0.5mm	MCV824-05	MCV825-05
1.0mm	MCV826-10	MCV827-10
1.5mm	MCV828-15	MCV829-15
2.0mm	MCV830-20	MCV831-20
2.5mm	MCV832-25	MCV833-25
3.0mm	MCV834-30	MCV835-30



DeBakey Vessel Dilator

- 190mm length
- Malleable shaft

diameter Ø		diameter Ø	
0.5mm	MCV836-05	3.5mm	MCV842-35
1.0mm	MCV837-10	4.0mm	MCV843-40
1.5mm	MCV838-15	4.5mm	MCV844-45
2.0mm	MCV839-20	5.0mm	MCV845-50
2.5mm	MCV840-25	7.0mm	MCV846-70
3.0mm	MCV841-30	9.0mm	MCV847-90

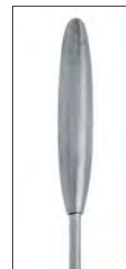

Garrett Vessel Dilator

- Malleable shaft

diameter Ø	14cm length	diameter Ø	21cm length
1.0mm	MCV848-10	1.0mm	MCV857-10
1.5mm	MCV849-15	1.5mm	MCV858-15
2.0mm	MCV850-20	2.0mm	MCV859-20
2.5mm	MCV851-25	2.5mm	MCV860-25
3.0mm	MCV852-30	3.0mm	MCV861-30
3.5mm	MCV853-35	3.5mm	MCV862-35
4.0mm	MCV854-40	4.0mm	MCV863-40
4.5mm	MCV855-45	4.5mm	MCV864-45
5.0mm	MCV856-50	5.0mm	MCV865-50



Rummel Cardiac Stilette

- Suture Hook
- 32.5cm length



MCV866-32