

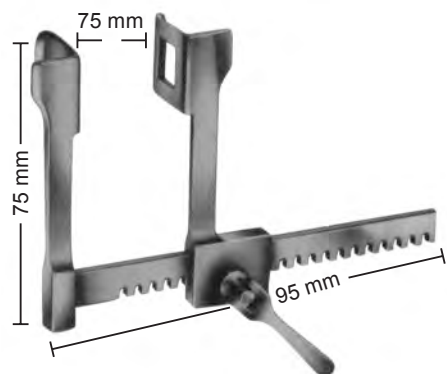

Page 01-63

- Cardiovascular And Thoracic
- Surgery Muller Vessel Clips
- Bulldog Clamps



PQ-001
FINOCHIETTO
for children
18X21 mm

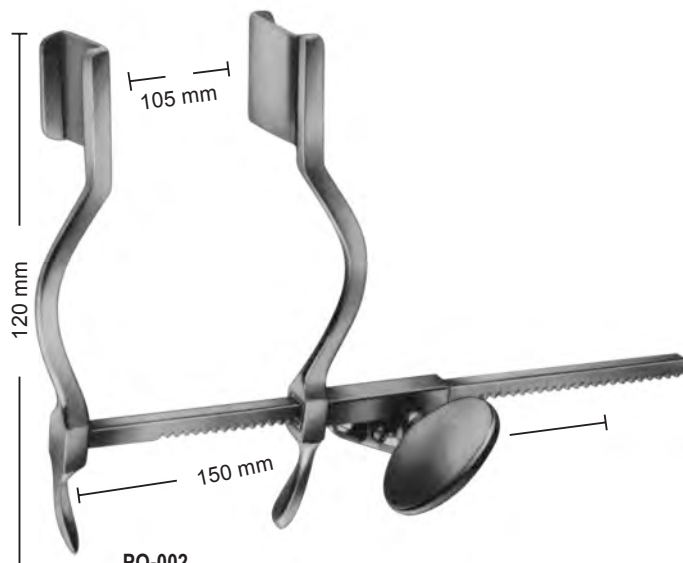

PQ-002
HERTZLER
for children
20X25 mm

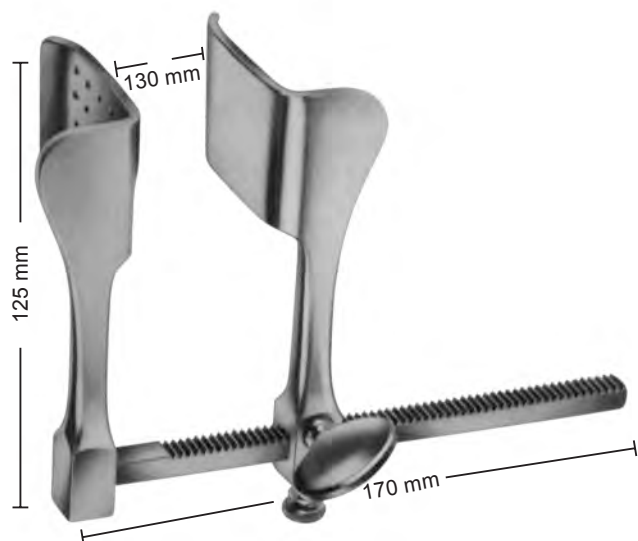

PQ-003
TUFFIER
Blades
43X53 mm

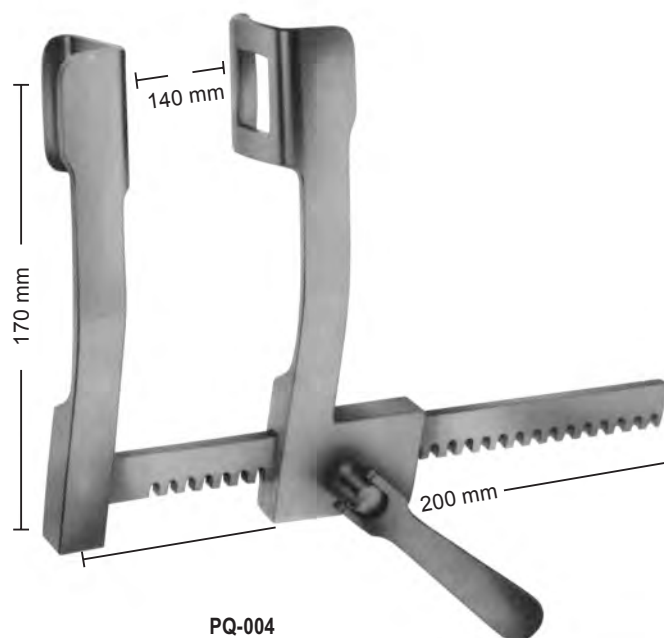

PQ-004
FINOCHIETTO
Blades
36X45 mm



RIB SPREADERS

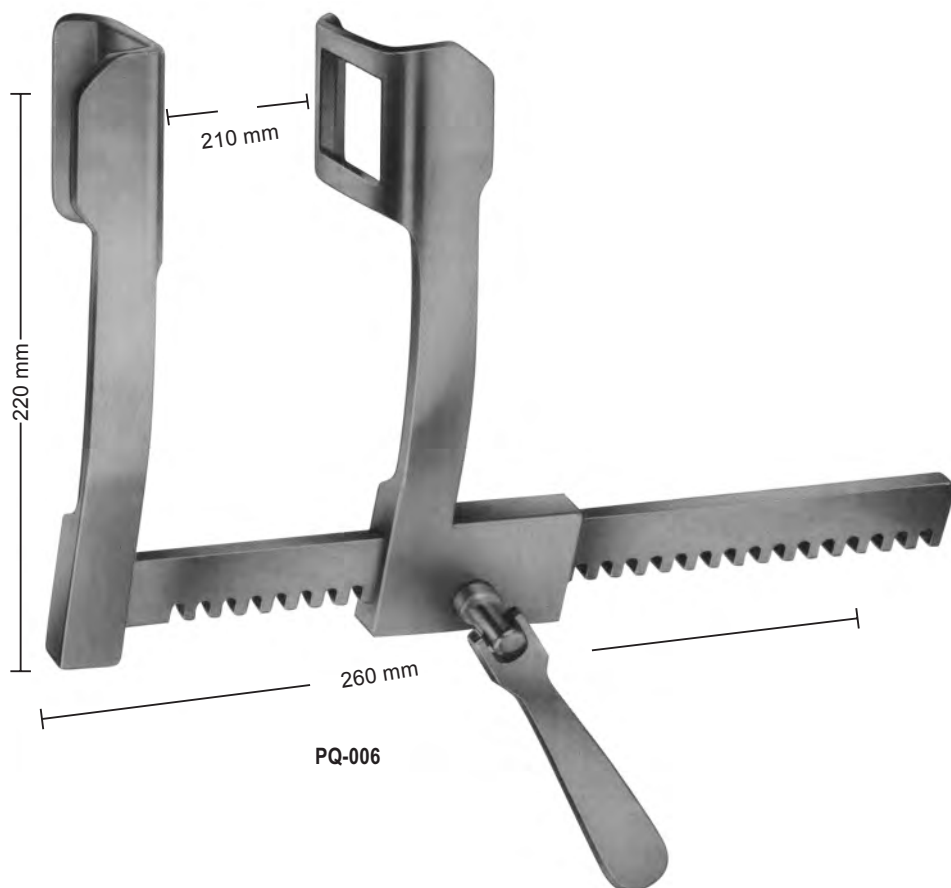
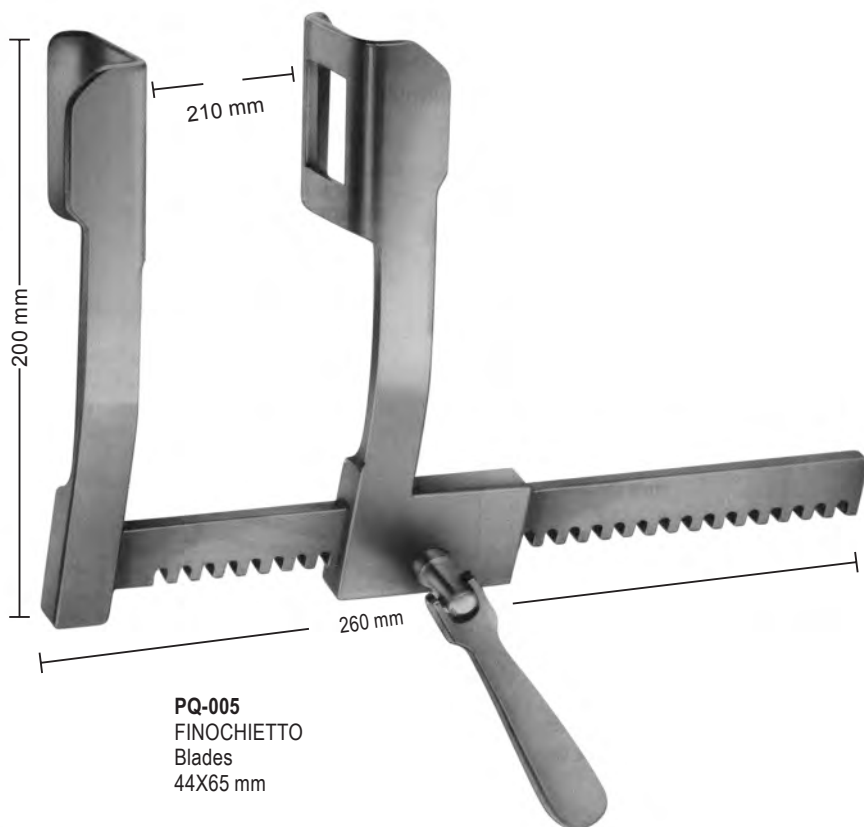



PQ-007
Blades
46x67 mm



PQ-008
Blades
80x67 mm



PQ-009
Blades
46x67 mm

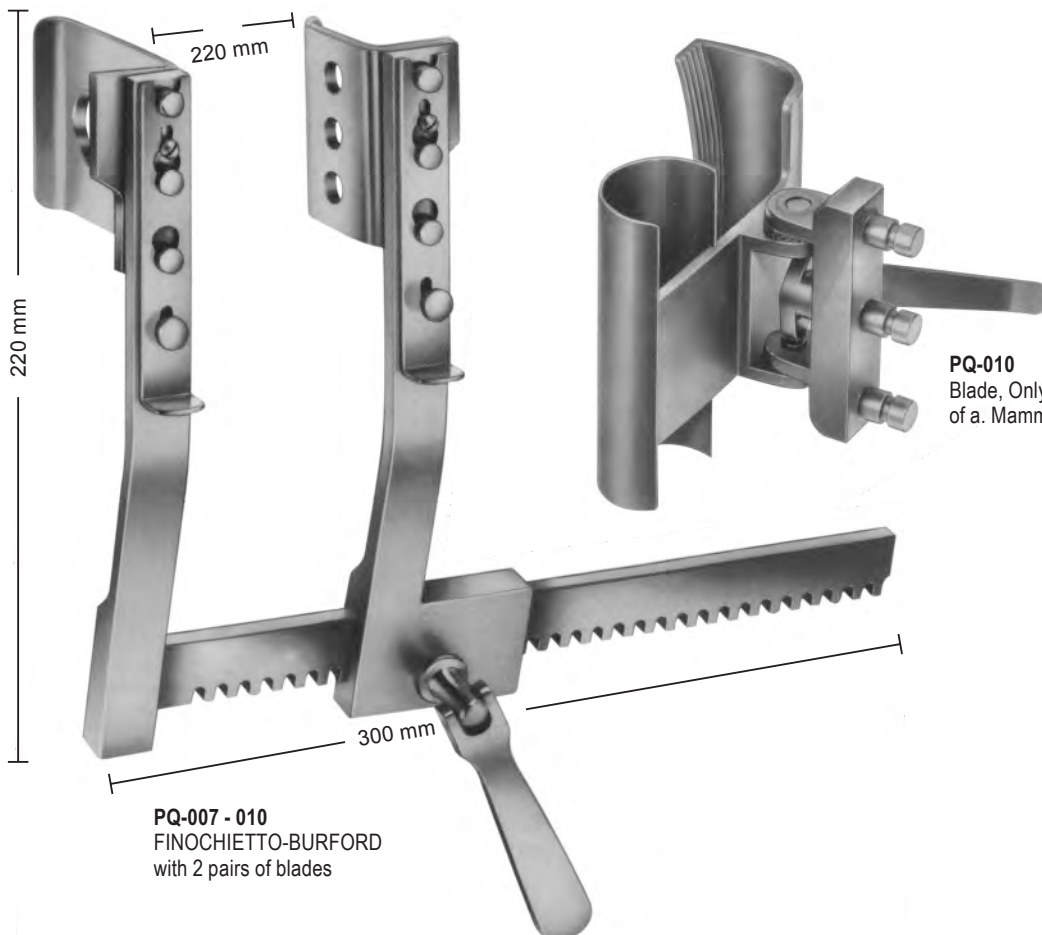



RIB SPREADERS

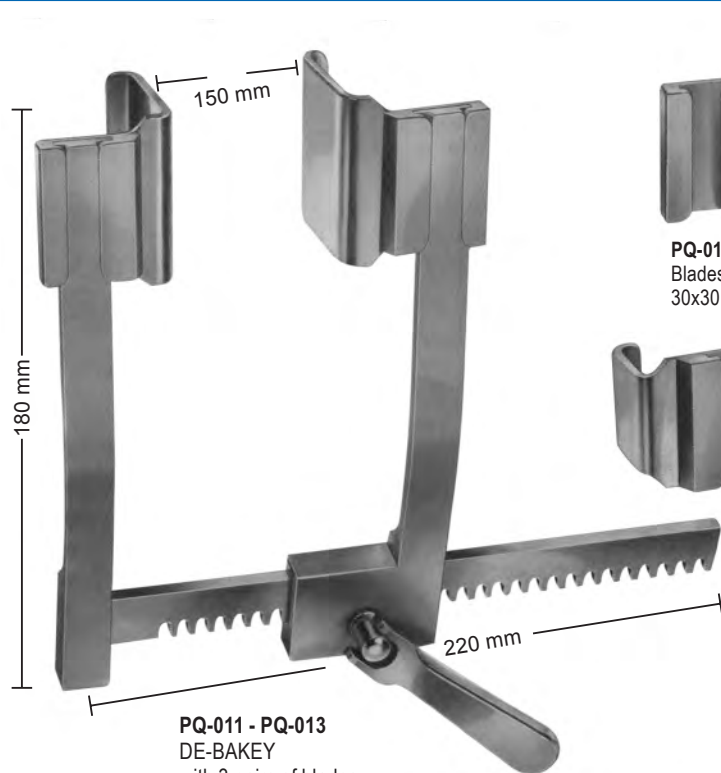

PQ-011 - PQ-013
DE-BAKEY
with 3 pairs of blades



PQ-011
Blades
30x30 mm



PQ-012
Blades
40x40 mm



PQ-013
Blades
50x50 mm

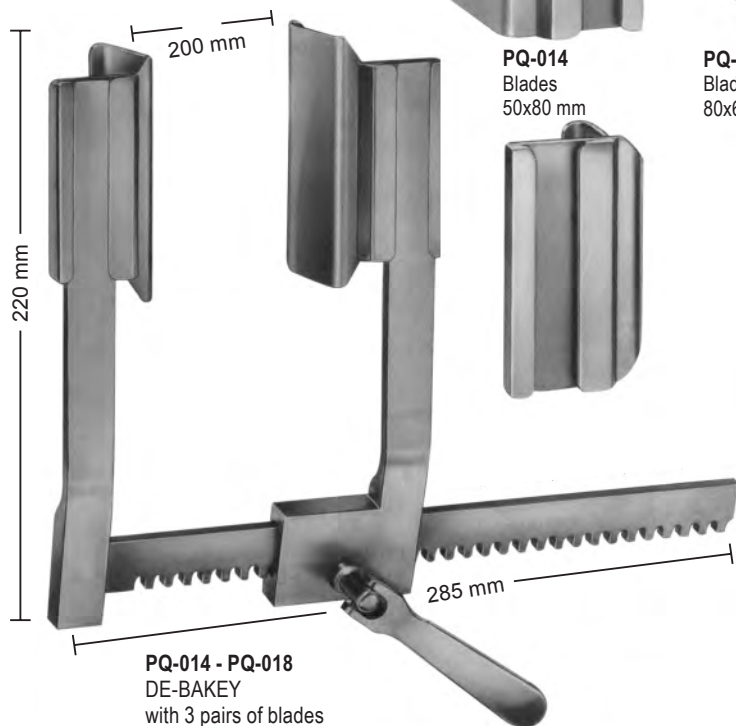
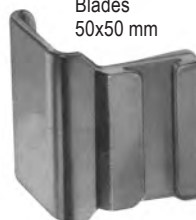

PQ-014 - PQ-018
DE-BAKEY
with 3 pairs of blades



PQ-014
Blades
50x80 mm



PQ-015
Blades
80x60 mm



PQ-016
Blades
50x80 mm



PQ-017
Blades
40x100 mm



PQ-018
Sternotomy Blades
50x660 mm



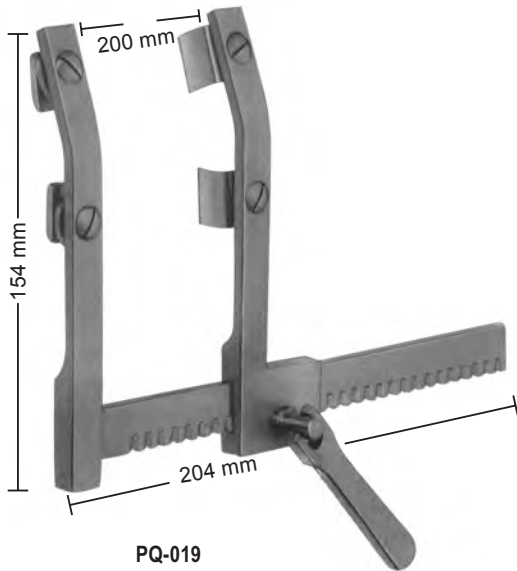

PQ-019
MORSE
Sternotomy spreader
for children, with moveable
double, each blade
12x20 mm

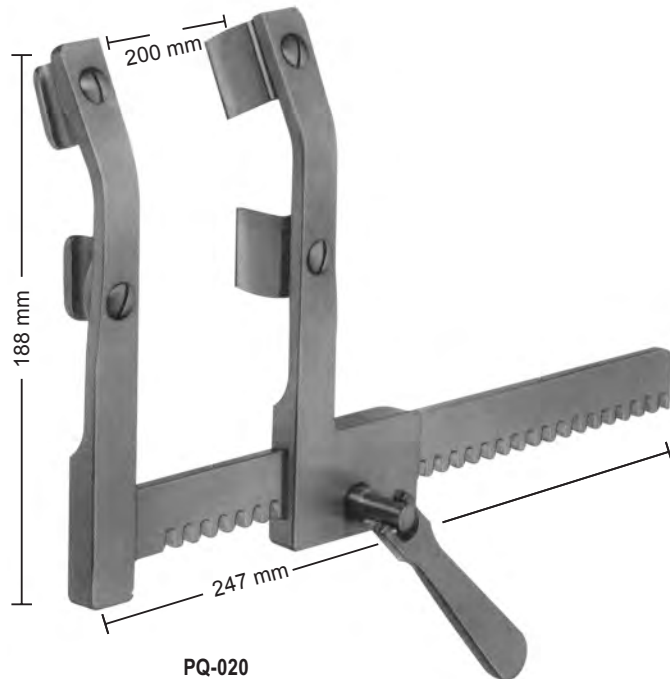

PQ-020
MORSE
Sternotomy spreader
for adults, with moveable
double, each blade
19x19 mm



STERNUM-SPREADERS

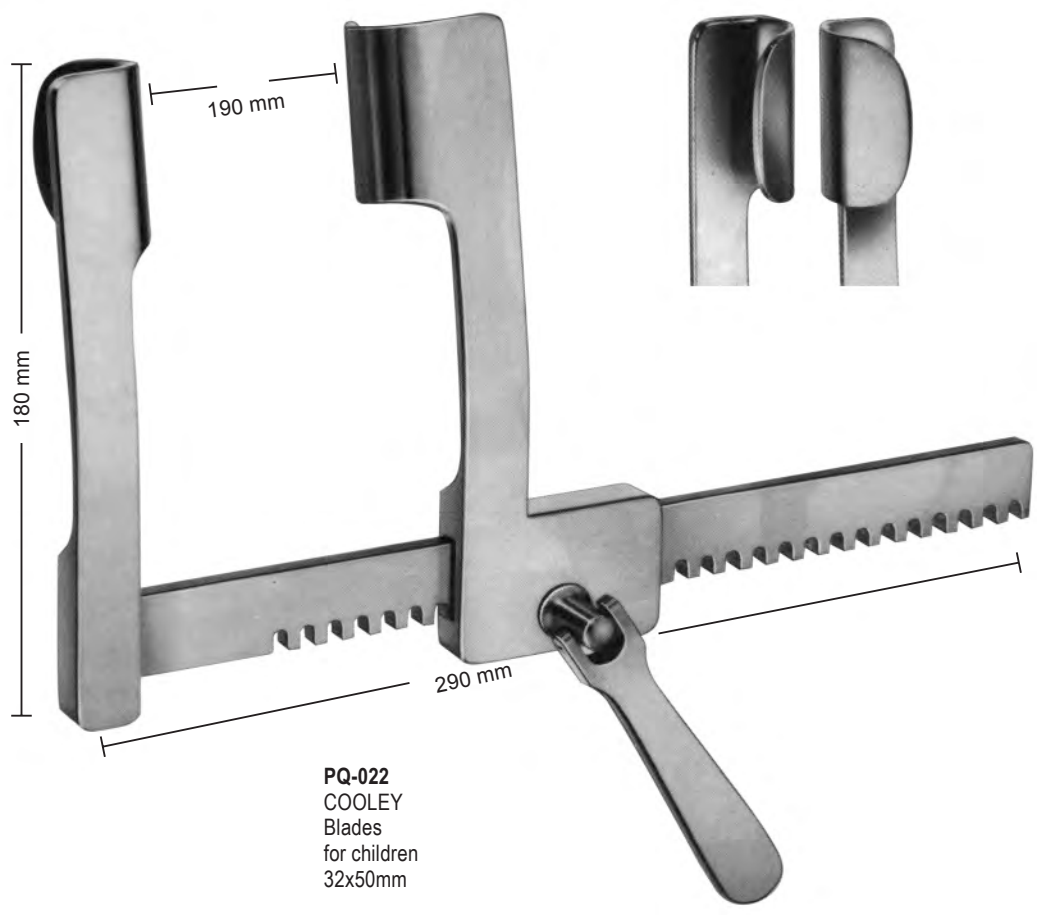
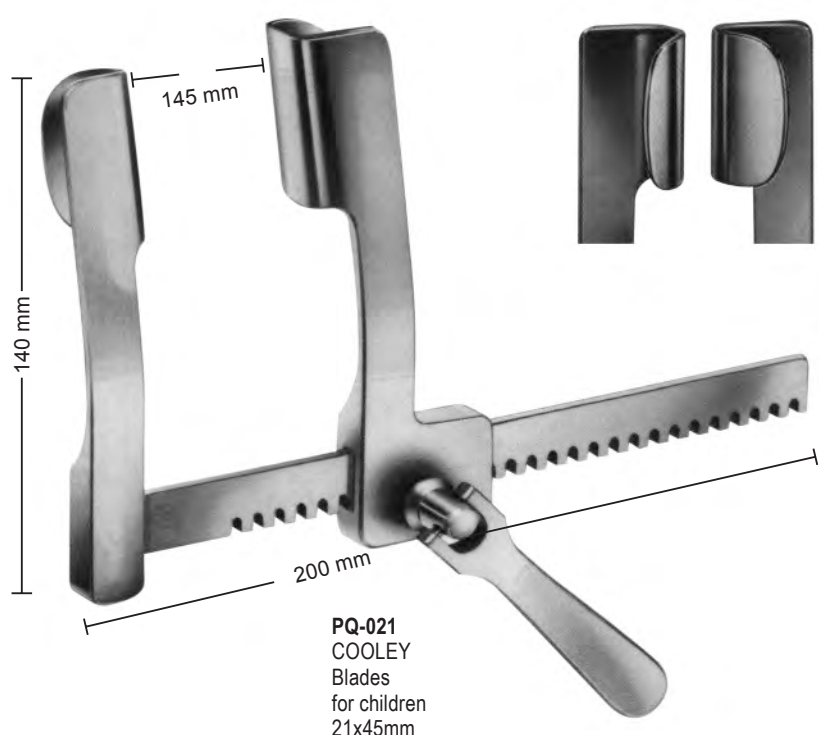

STAINLESS STEEL

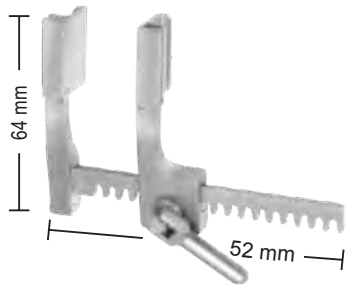

PQ-023 - PQ-024
for blades, with 2 pairs of blades
9X20 mm 9X10 mm, spreading 52 mm



PQ-023
Blades, only
9x20 mm



PQ-024
Blades, only
9x10 mm

ALUMINIUM

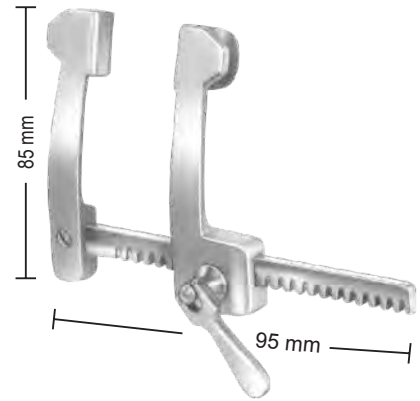

COOLEY PQ-025
for blades, lateral blades 12X16 mm,
spreading 95 mm

ALUMINIUM

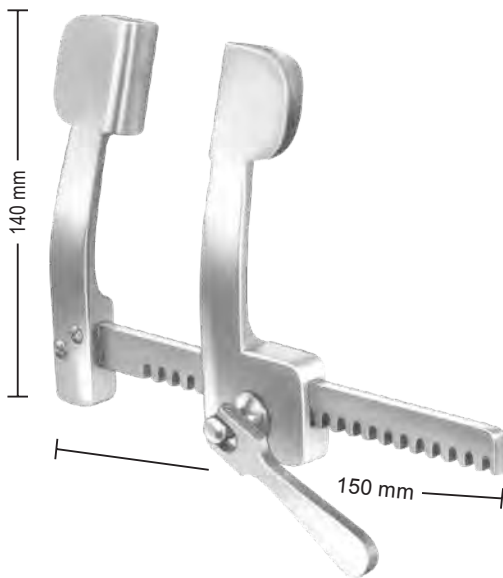

COOLEY PQ-026
for children, lateral blades 21X44 mm,
spreading 150 mm

ALUMINIUM

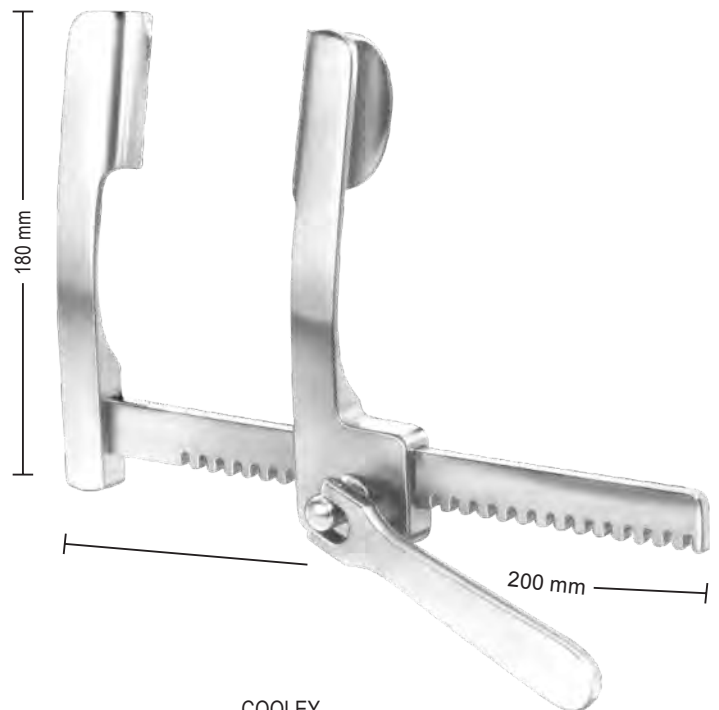

COOLEY PQ-027
for adults, lateral blades 35X50 mm,
spreading 200 mm

RIB RETRACTORS

ALUMINIUM

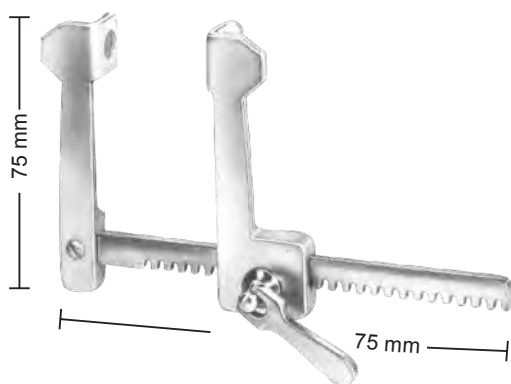

FINOCHIETTO, INFANT
PQ-028
 for children, lateral blades 15X15 mm,
 spreading 75 mm

STAINLESS STEEL

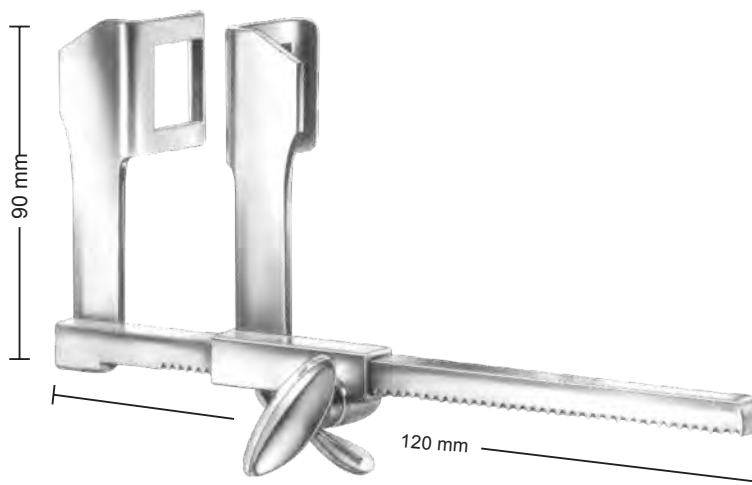

HAIGHT
PQ-029
 lateral blades 30X30 mm,
 spreading 120 mm

ALUMINIUM

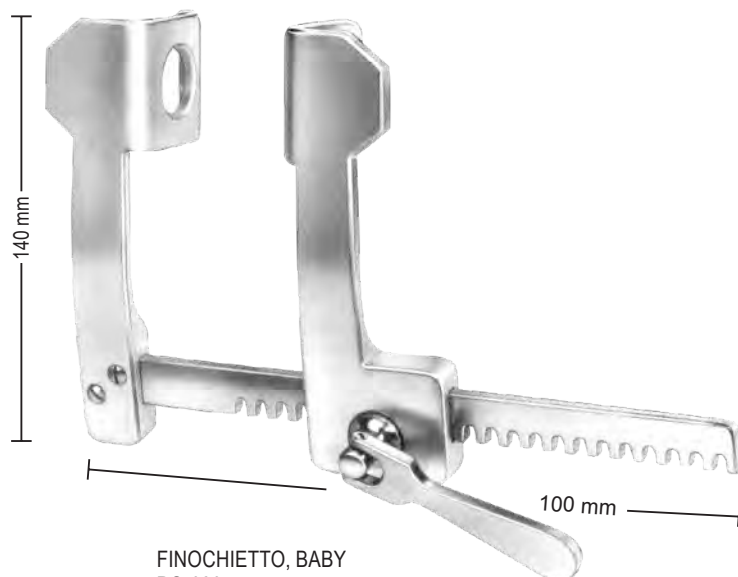

FINOCHIETTO, BABY
PQ-030
 for children, lateral blades 31X31 mm,
 spreading 100 mm

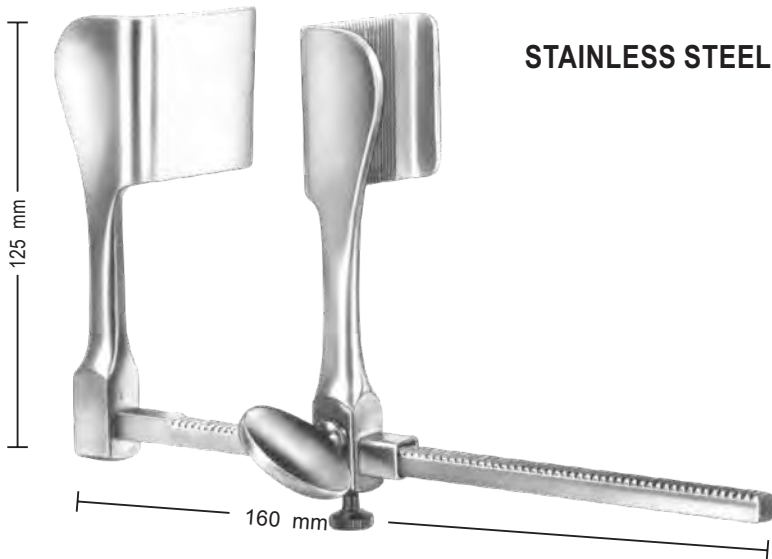

TUFFIER
PQ-031
 lateral blades 45X45 mm,
 spreading 160 mm

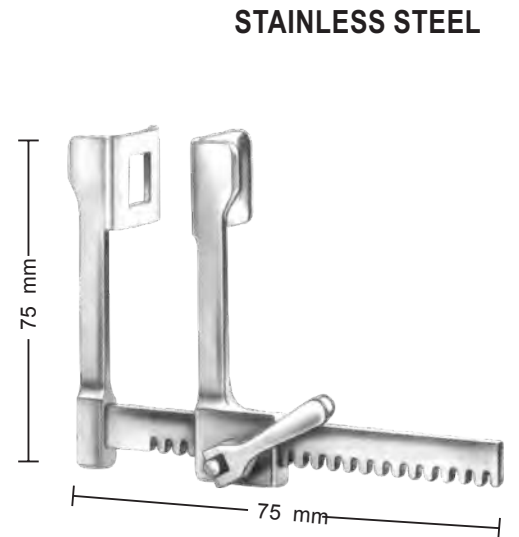

FINOCHIETTO, BABY
PQ-032
 lateral blades 14X15 mm,
 spreading 75 mm



FINOCHIETTO
PQ-033
 lateral blades 30X45 mm, 46X62 mm , 80X65 mm,
 spreading 150 mm, 190 mm, 190 mm



THORACIC RETRACTORS



PQ-035
Blades
75x75 mm



PQ-036
Blades
42x65 mm



Blades with Ball Snap System
Delivery: in Pairs

- PQ-034 - PQ-036**
 Thoraxsperrer (Mercedes-Sperrer)
 complete consisting of:
PQ-034 Retractor only
PQ-035 1 Pair of blades 42x65 mm
PQ-036 1 Pair of blades 75x75 mm



PQ-037
SELLORS
Rib spreader and contractor
with swivel blades
200 mm



PQ-038
BAILEY
150 mm



PQ-039
for children

PQ-040
for children

PQ-039 - PQ-041
BAILEY
200 mm



RING HANDLE BULLDOG CLAMPS

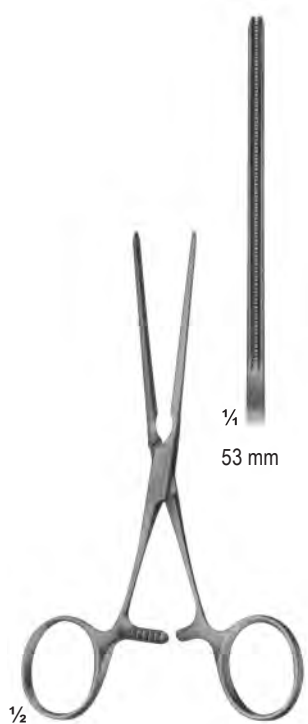

PQ-042
DE-BAKEY
gerade straight
130 mm

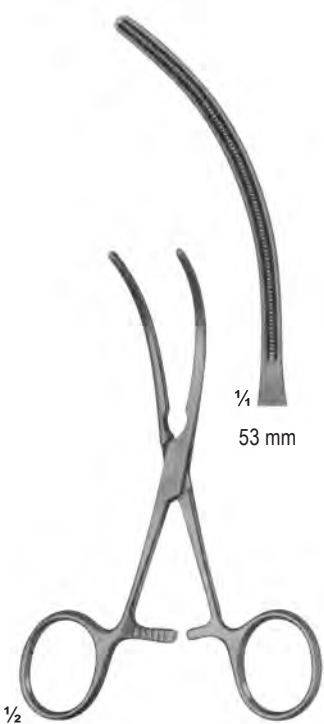

PQ-043
DE-BAKEY
Maul gebogen
curved jaws
125 mm

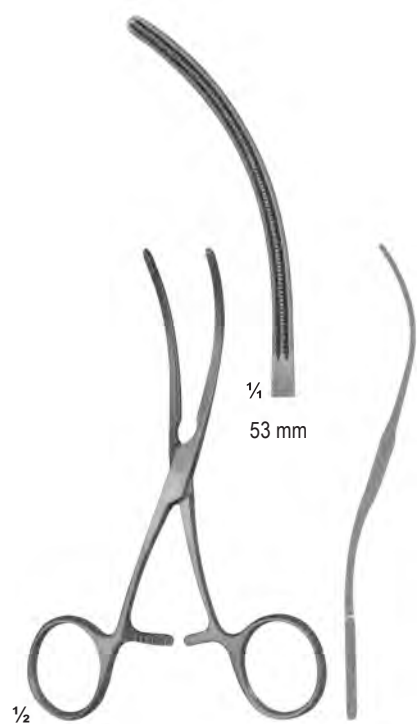

PQ-044
DE-BAKEY
S-shaped curved
125 mm

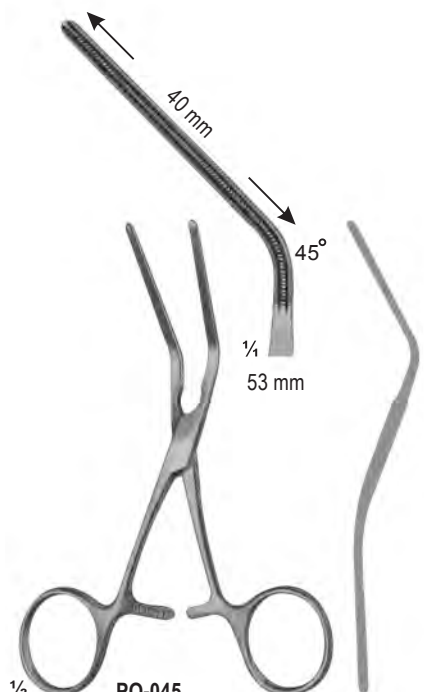

PQ-045
DE-BAKEY
45° winklig gebogen
angled 45°
125 mm

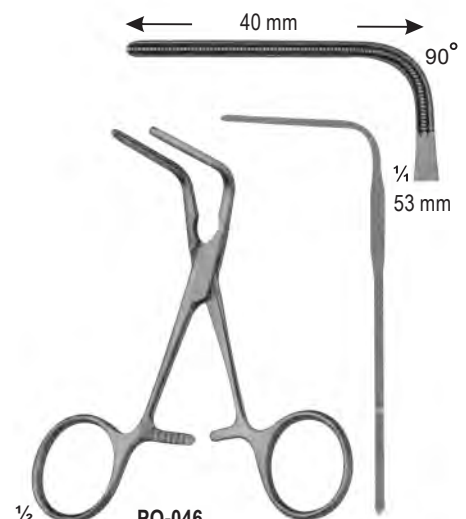

PQ-046
DE-BAKEY
90° winklig gebogen
angled 90°
105 mm

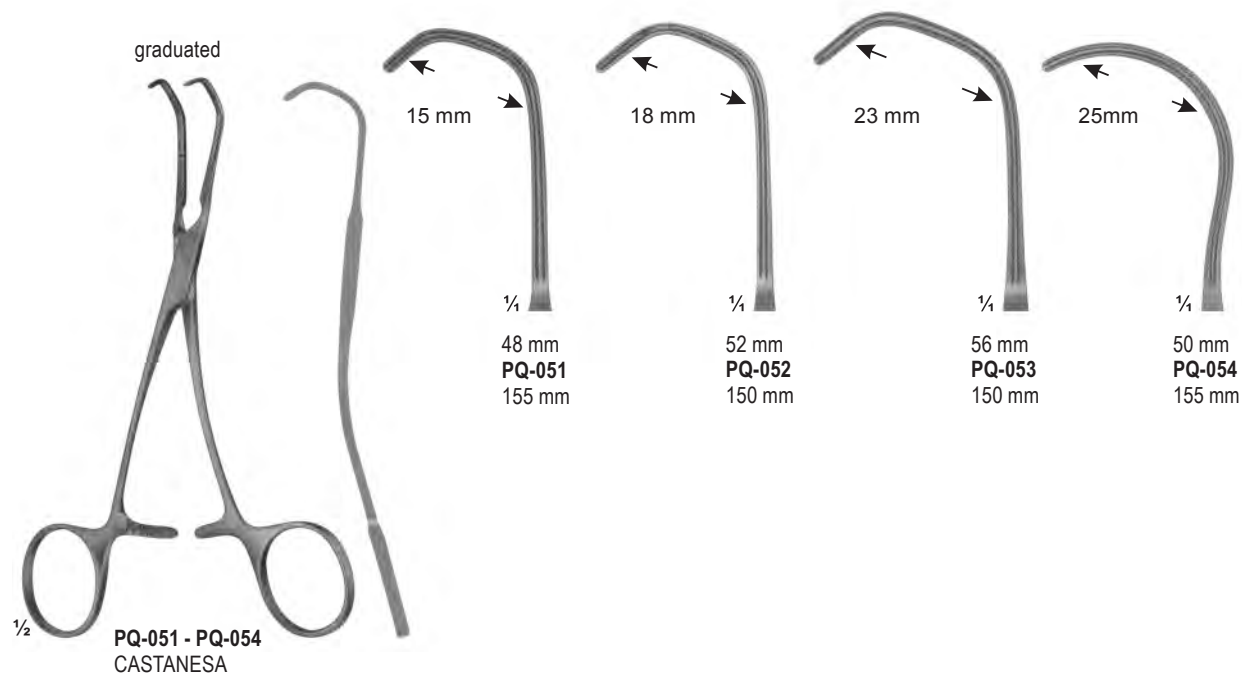
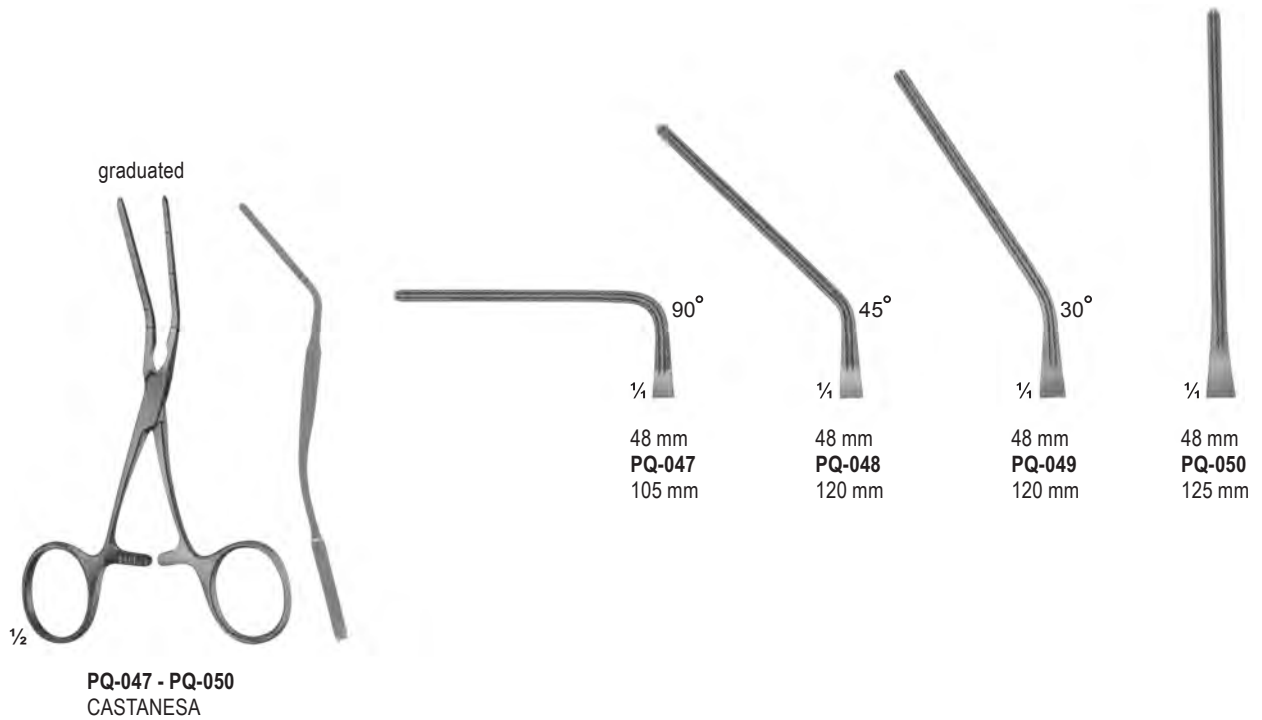



ANASTOMOSIS AND MULTI-PURPOSE-CLAMPS-PEDIATRIC TYPES

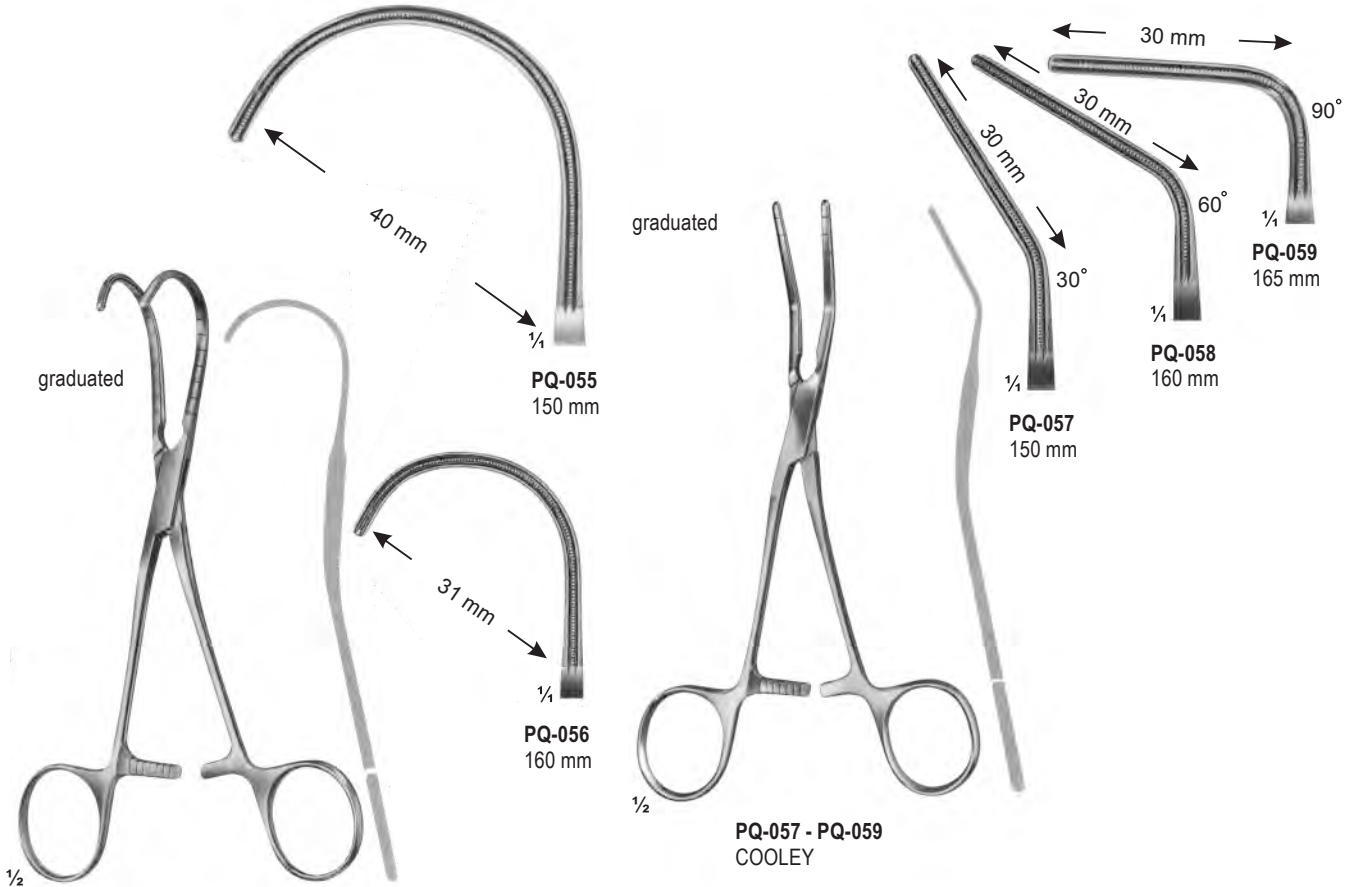

PQ-055 - PQ-056
DE BAKEY

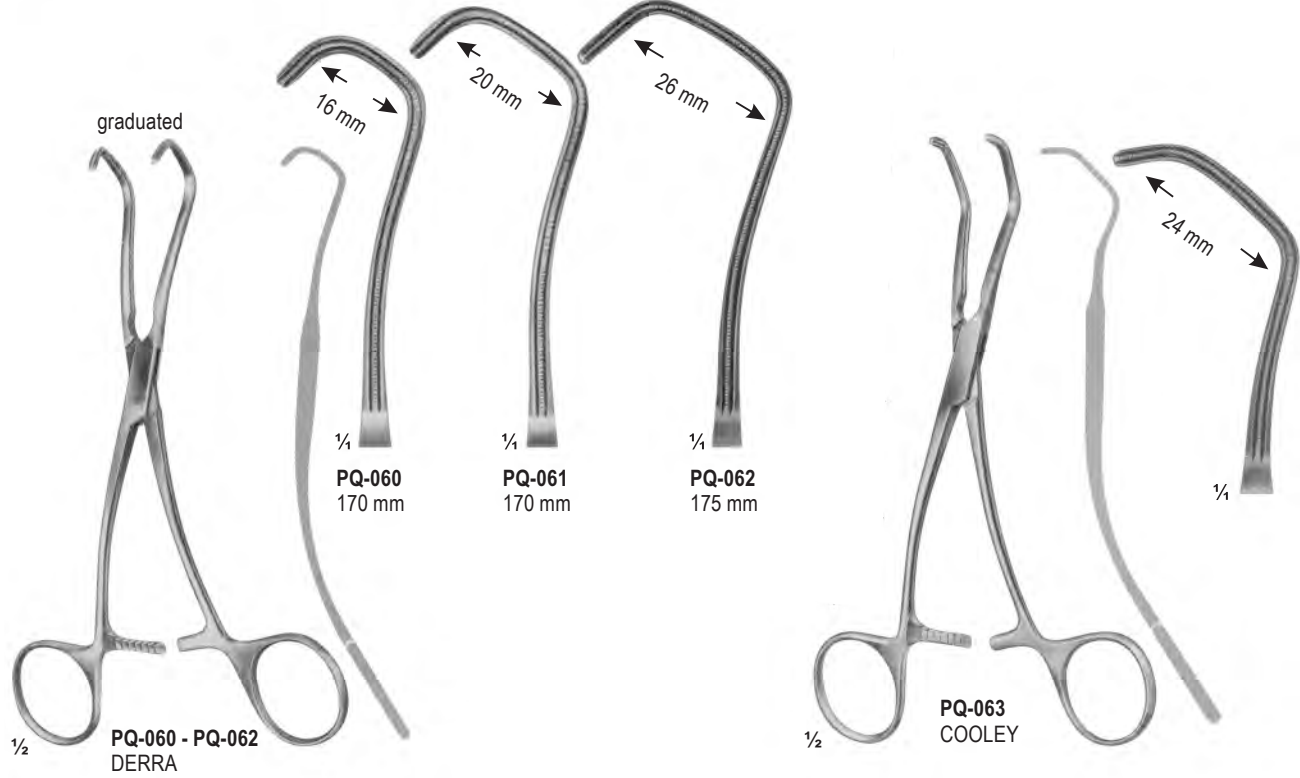

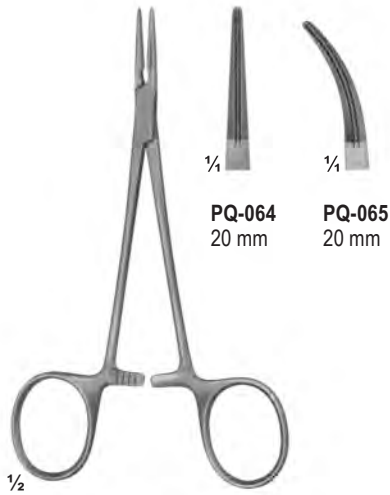

PQ-064
20 mm

PQ-065
20 mm

PQ-064 - PQ-065
HALSTED
125 mm

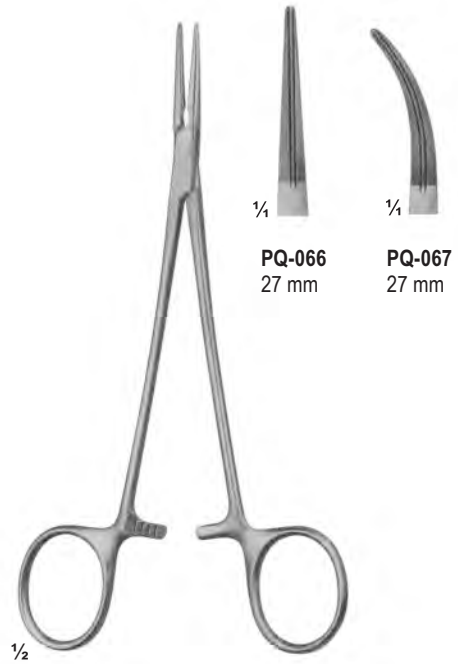

PQ-066
27 mm

PQ-067
27 mm

PQ-066 - PQ-067
RANKIN
165 mm

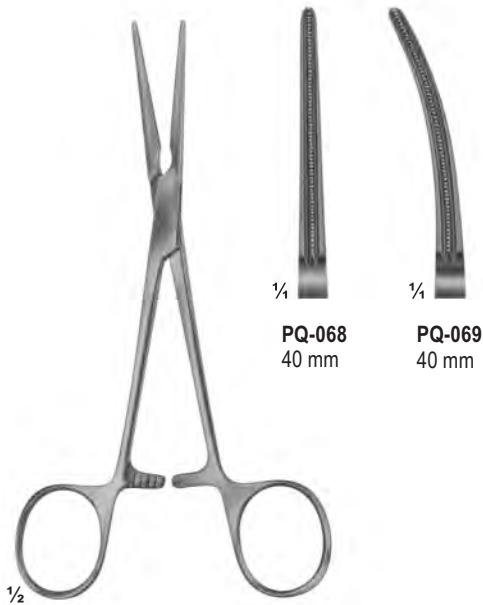

PQ-068
40 mm

PQ-069
40 mm

PQ-068 - PQ-069
DE BAKEY-BAINRIDGE
155 mm

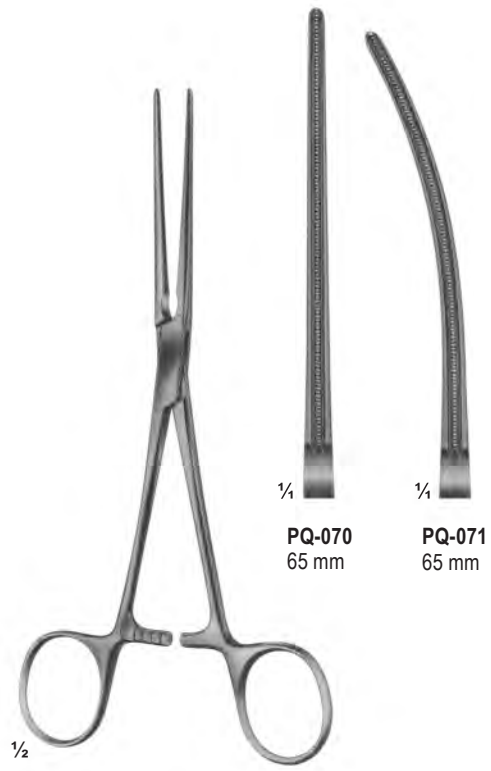

PQ-070
65 mm

PQ-071
65 mm

PQ-070 - PQ-071
DE BAKEY-BAINRIDGE
180 mm



NON-TRAUMATIC HAEMOSTATIC FORCEPS

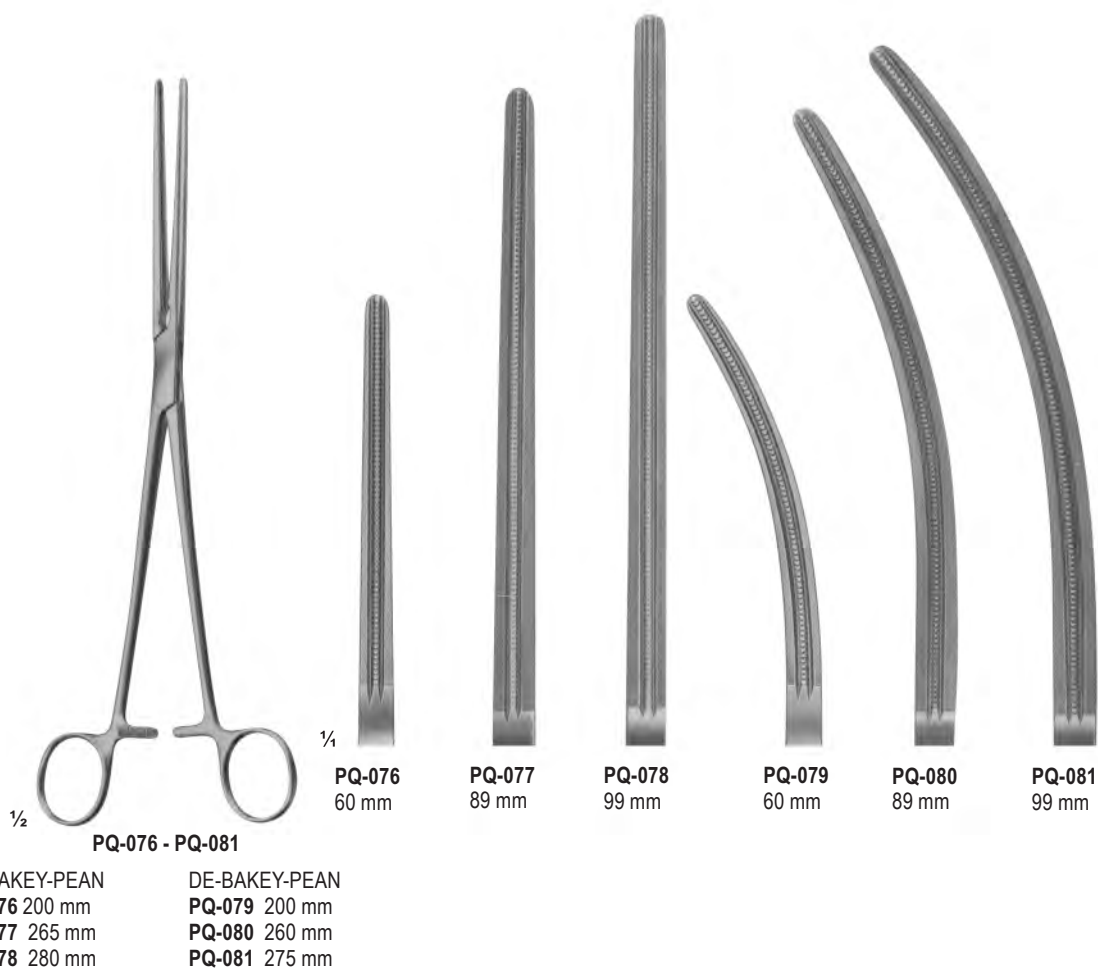
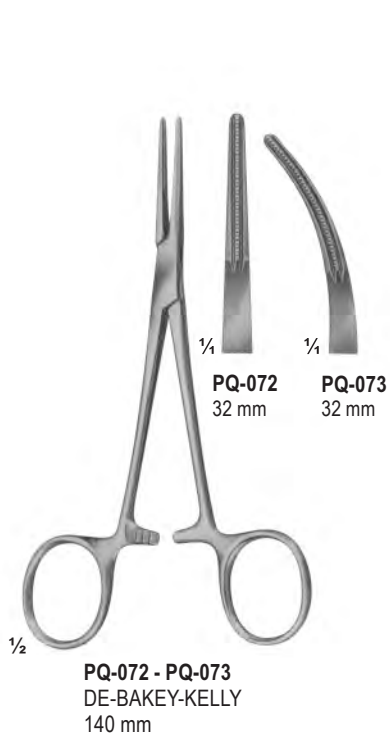

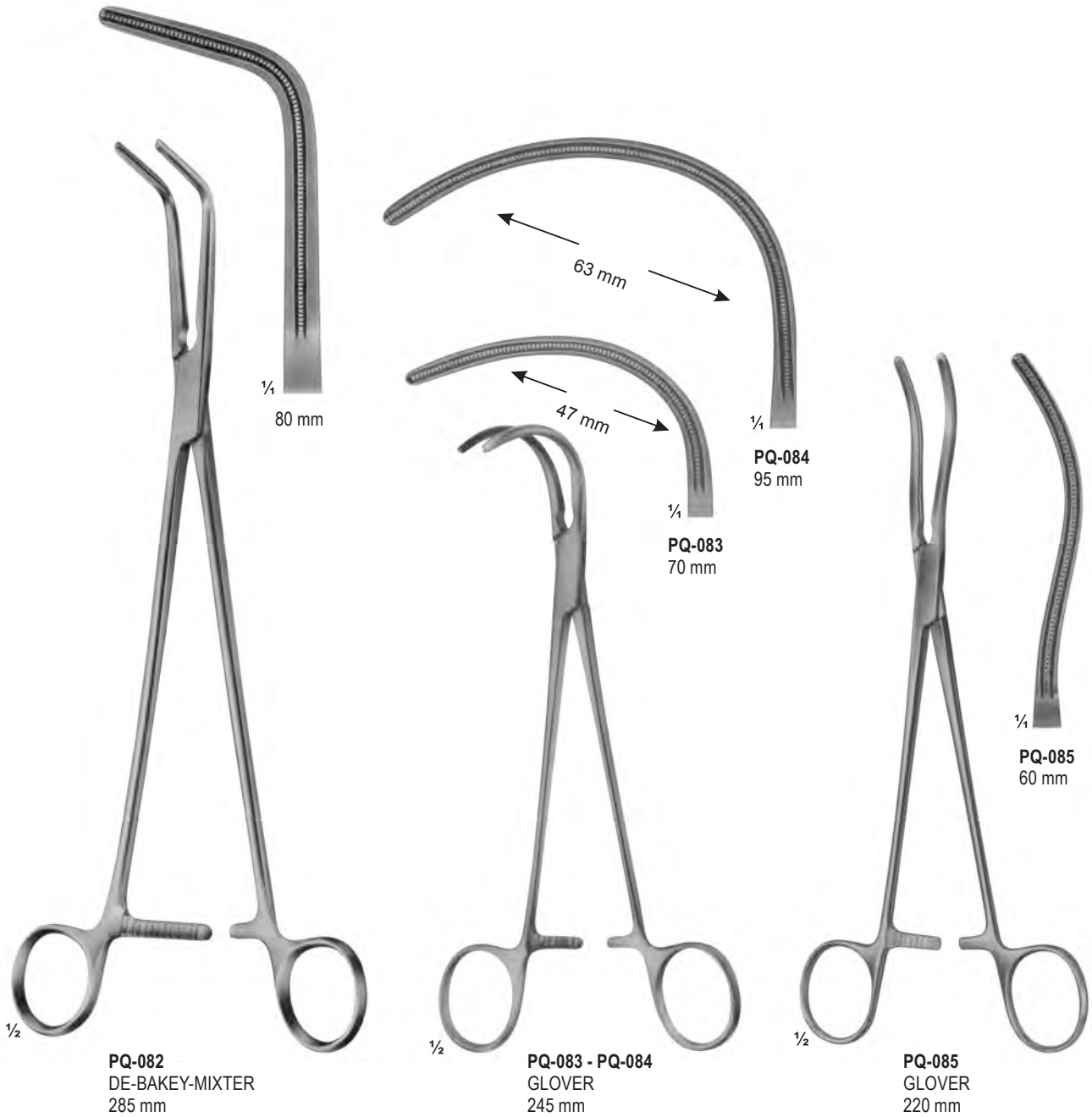



VENA-CAVA CLAMPS

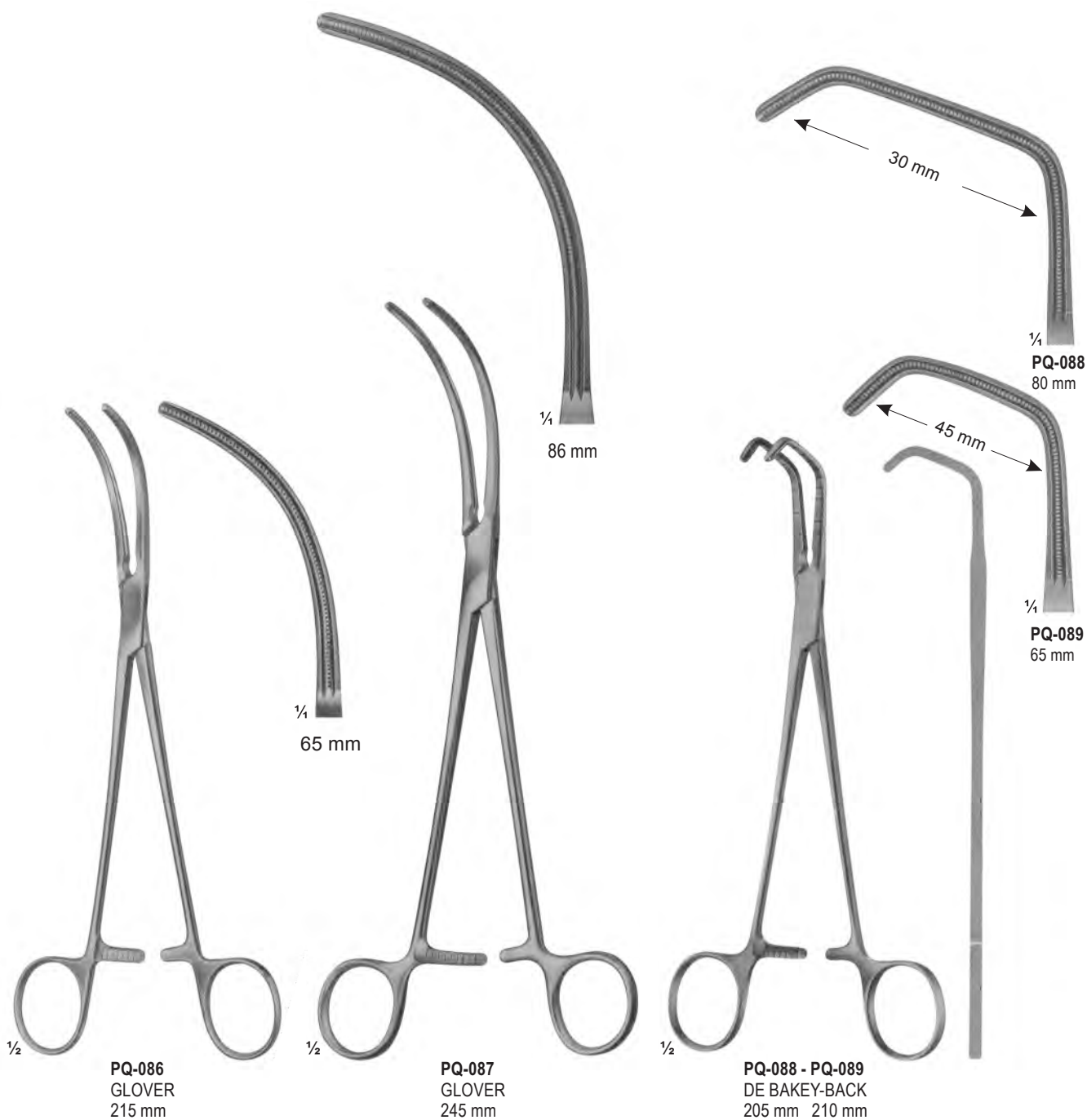



PQ-090 - PQ-093
DE BAKEY-HARKEN
PQ-090 - 255 mm
PQ-091 - 245 mm
PQ-092 - 245 mm
PQ-093 - 245 mm

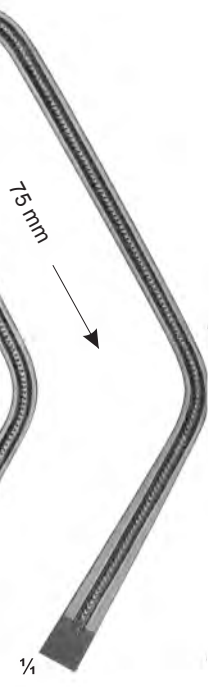
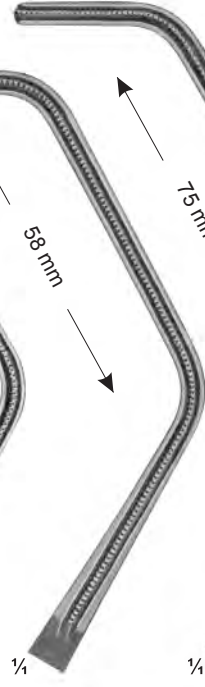
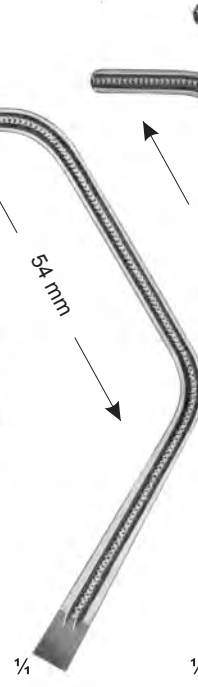
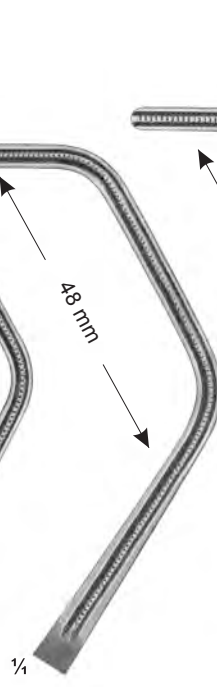
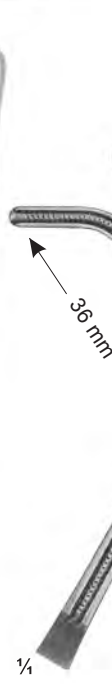

PQ-094 - PQ-098
DE BAKEY

Total Length:
Length of jaws:

PQ-094
220 mm
85 mm

PQ-095
256 mm
95 mm

PQ-096
270 mm
99 mm

PQ-097
270 mm
103 mm

PQ-098
280 mm
119 mm



NON-TRAUMATIC HAEMOSTATIC FORCEPS



DE-BAKEY-KELLY
PQ-099 - PQ-100
140 mm



PQ-099
32 mm



PQ-100
32 mm



PEAN
PQ-101 - PQ-102
155 mm



PQ-101
50 mm



PQ-102
50 mm



DE-BAKEY-PEAN
PQ-103 200 mm
PQ-104 265 mm
PQ-105 280 mm



PQ-103
60 mm



PQ-104
89 mm



PQ-105
99 mm



PQ-106
200 mm



PQ-107
260 mm

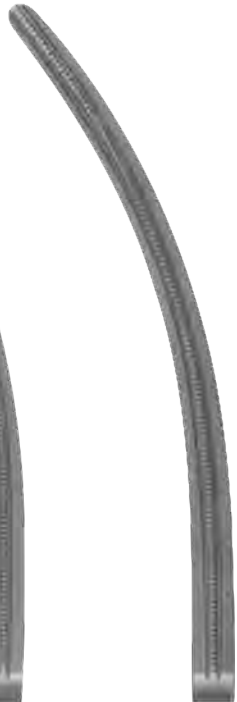

PQ-108
275 mm

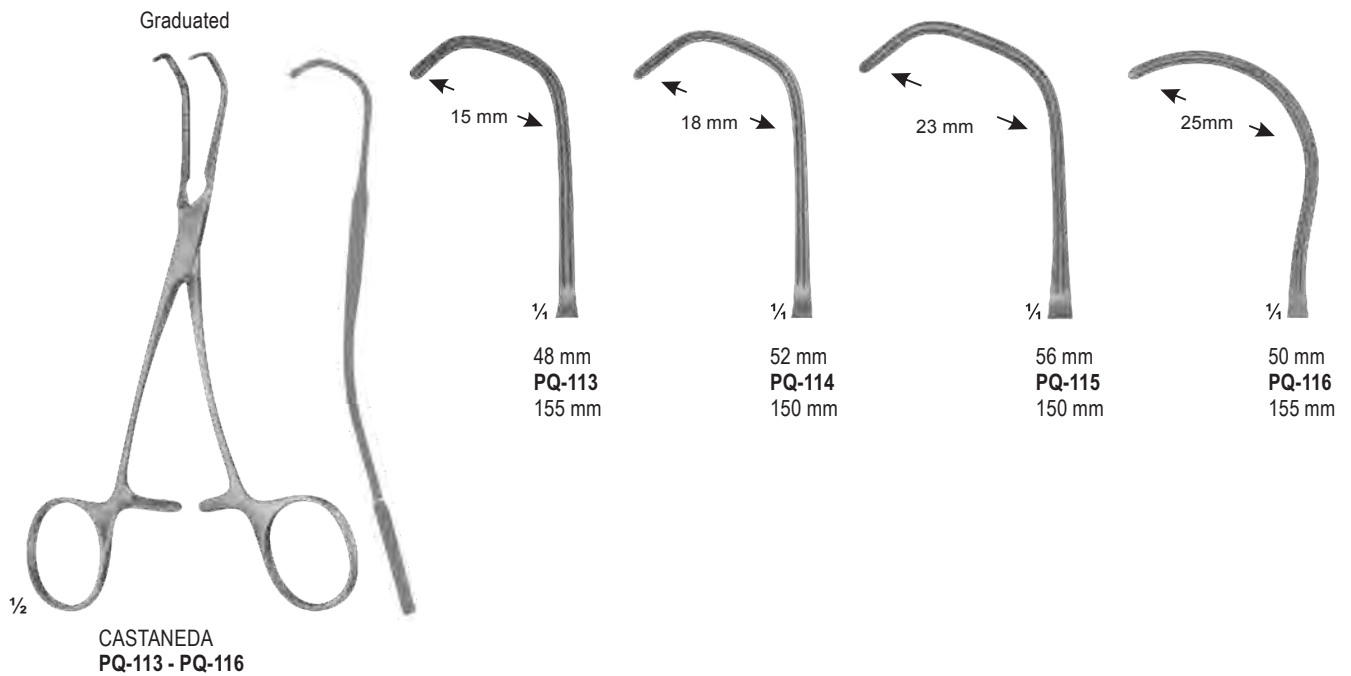
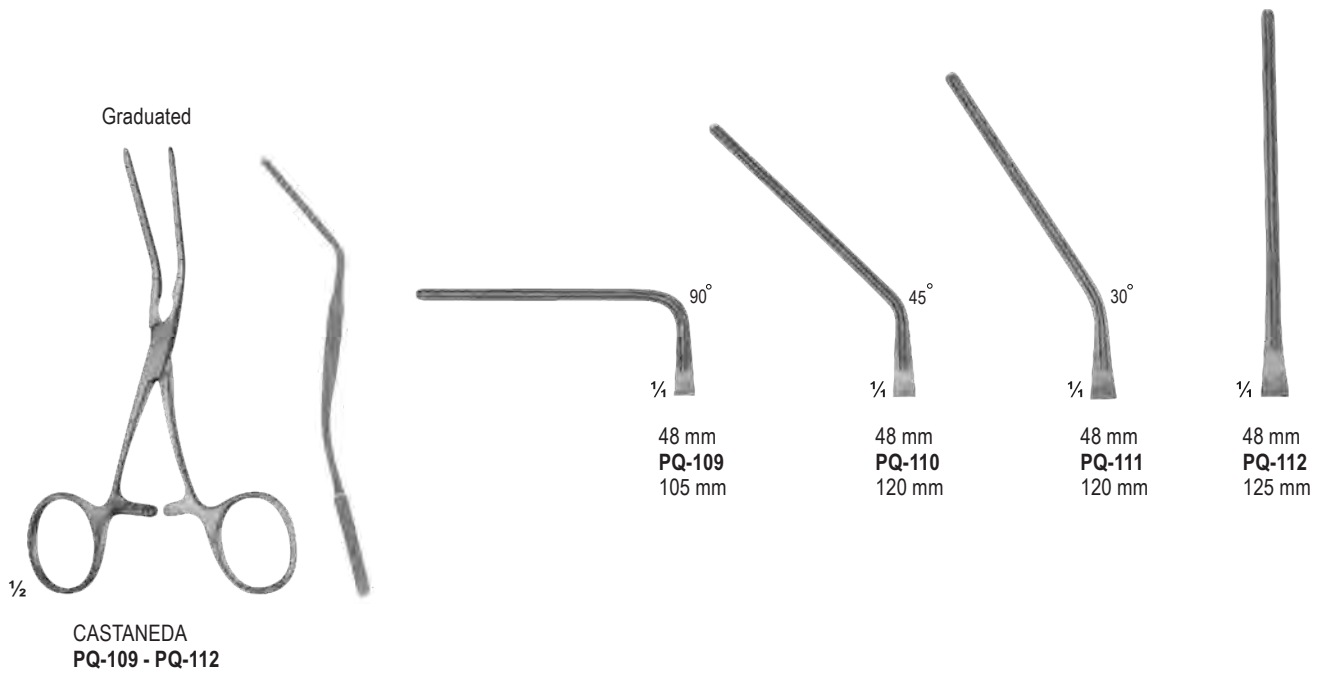



ANASTOMOSIS CLAMPS & VENA-CAVA CLAMPS



GLOVER
PQ-117 - PQ-118
245 mm

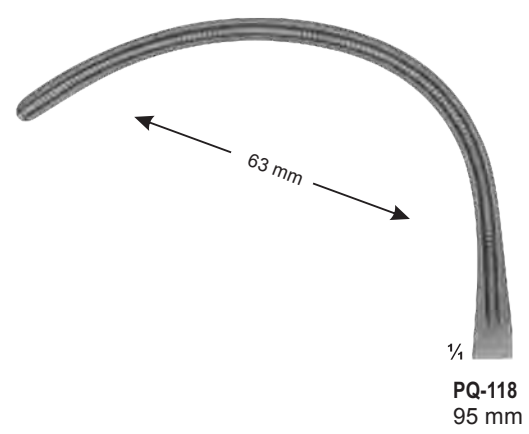

1/4
PQ-118
95 mm

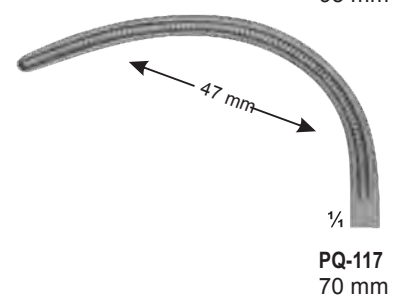

1/4
PQ-117
70 mm

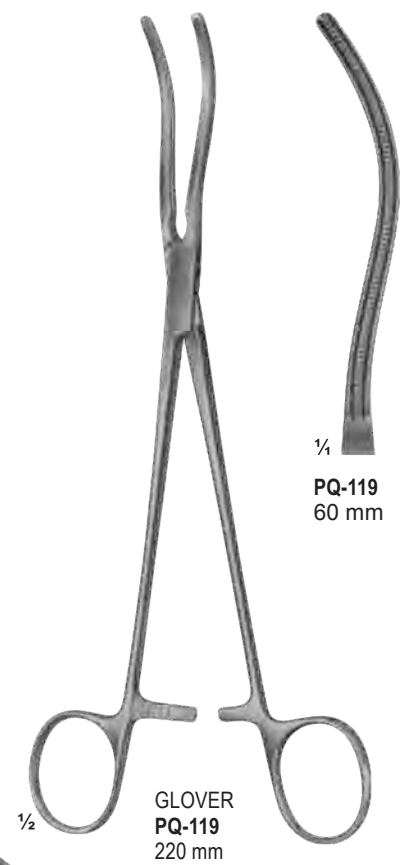

GLOVER
PQ-119
220 mm

1/4
PQ-119
60 mm

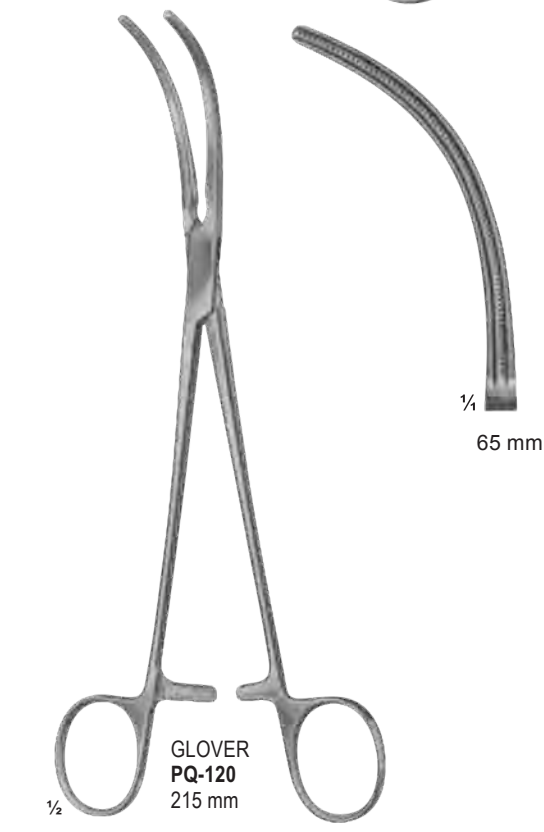

GLOVER
PQ-120
215 mm



1/4
65 mm

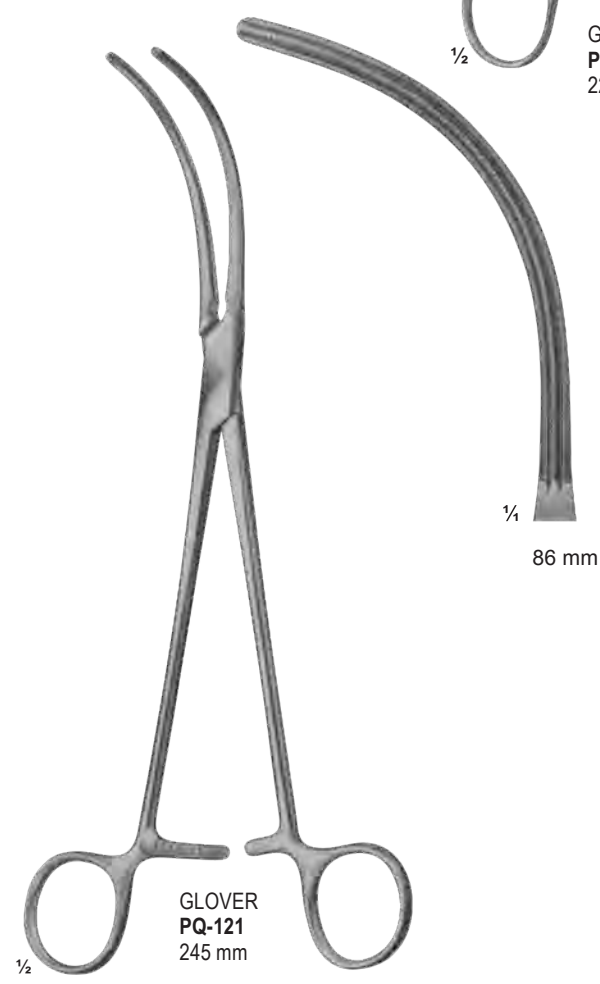

GLOVER
PQ-121
245 mm



1/4
86 mm



DE BAKEY-BACK
PQ-122 20.5 cm
PQ-123 21 cm

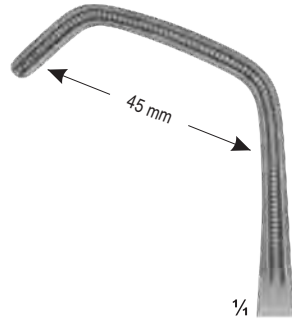

PQ-122
 65 mm

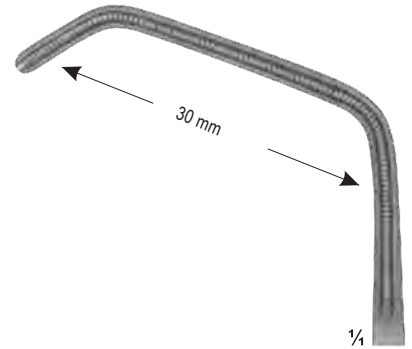

PQ-123
 80 mm



PQ-124
 86 mm



PQ-125
 86 mm



PQ-126
 86 mm

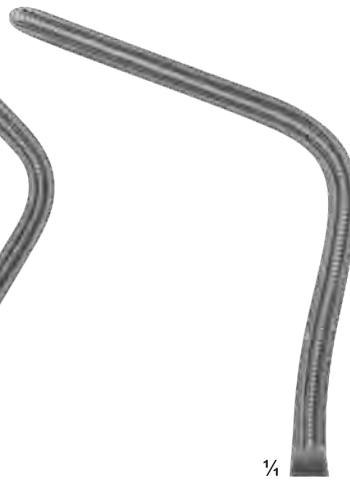

PQ-127
 86 mm



DE BAKEY-HARKEN
PQ-124 25.5 cm
PQ-125 24.5 cm
PQ-126 24.5 cm
PQ-127 24.5 cm



MULTI-PURPOSE CLAMPS

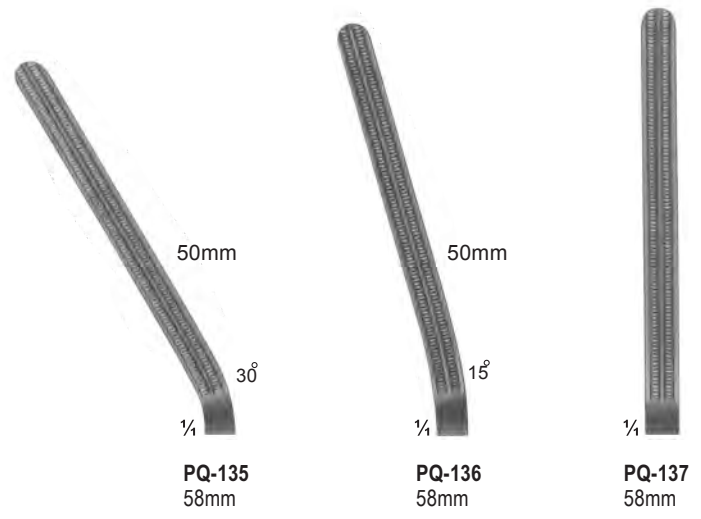
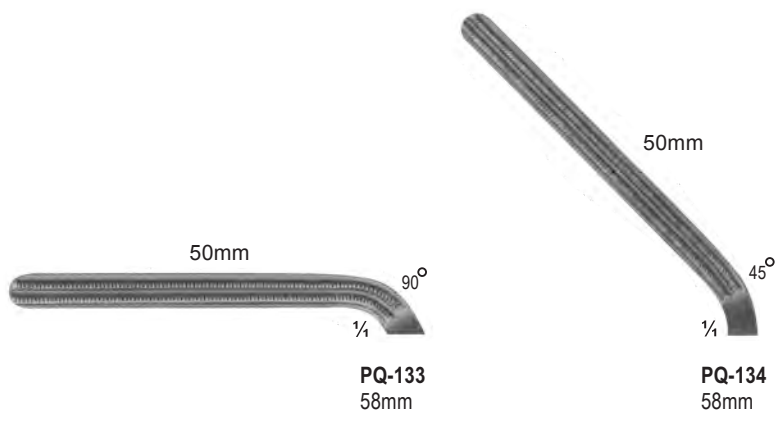
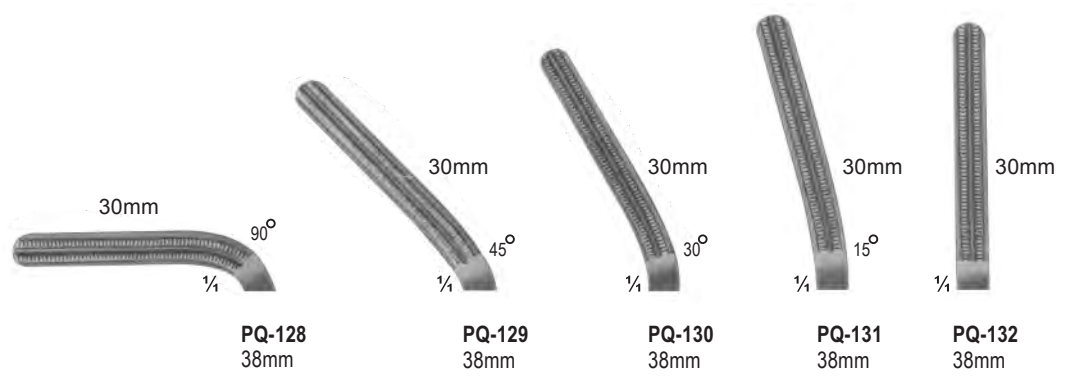

- DARDIK
- | | | | |
|--------|---------|--------|---------|
| PQ-128 | 15 cm | PQ-133 | 17 cm |
| PQ-129 | 15 cm | PQ-134 | 17 cm |
| PQ-130 | 15 cm | PQ-135 | 17 cm |
| PQ-131 | 14.5 cm | PQ-136 | 16 cm |
| PQ-132 | 13 cm | PQ-137 | 13.5 cm |

ATRAUMA

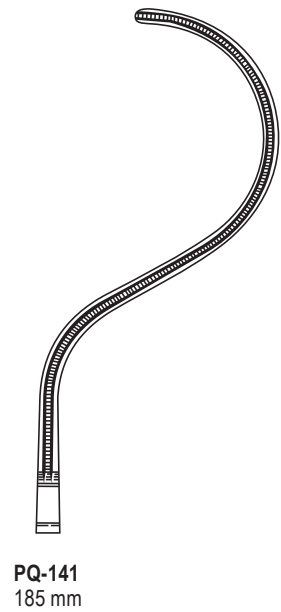
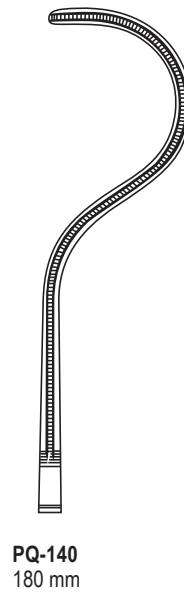
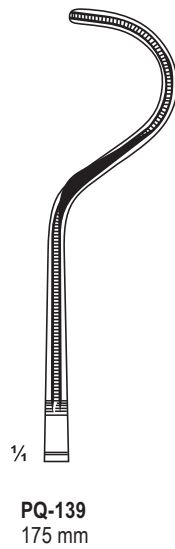
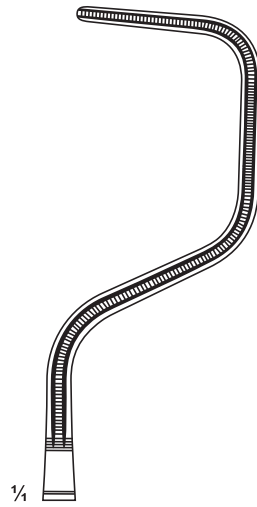
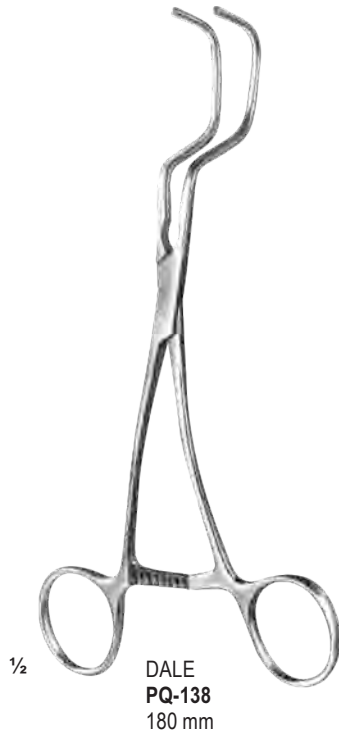



AORTIC CLAMPS

ATRAUMA

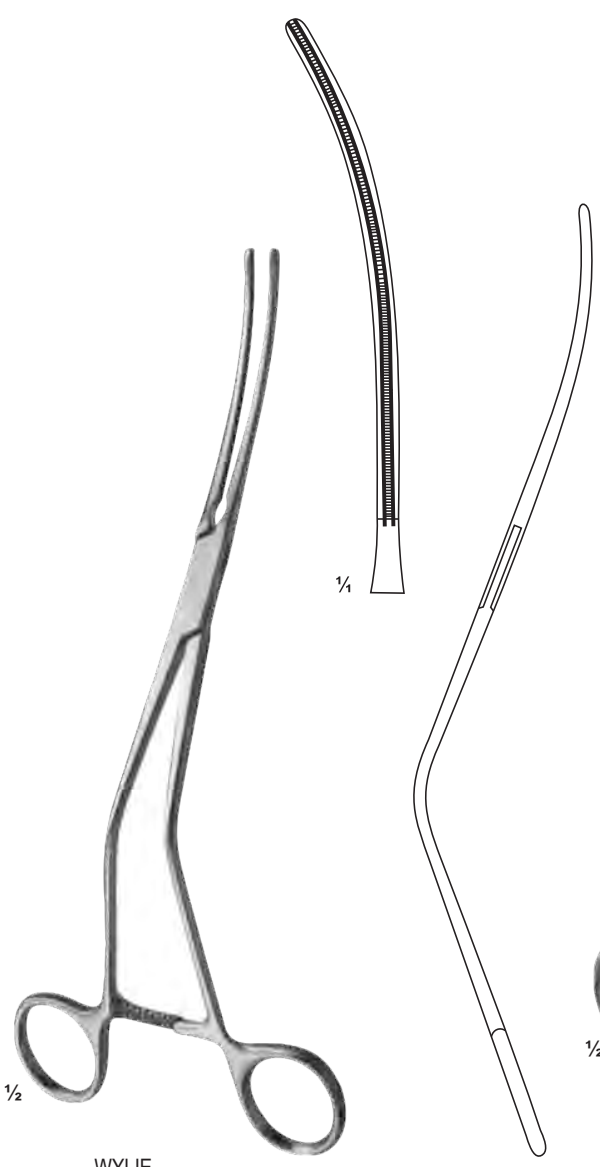

WYLIE
PQ-142
240 mm

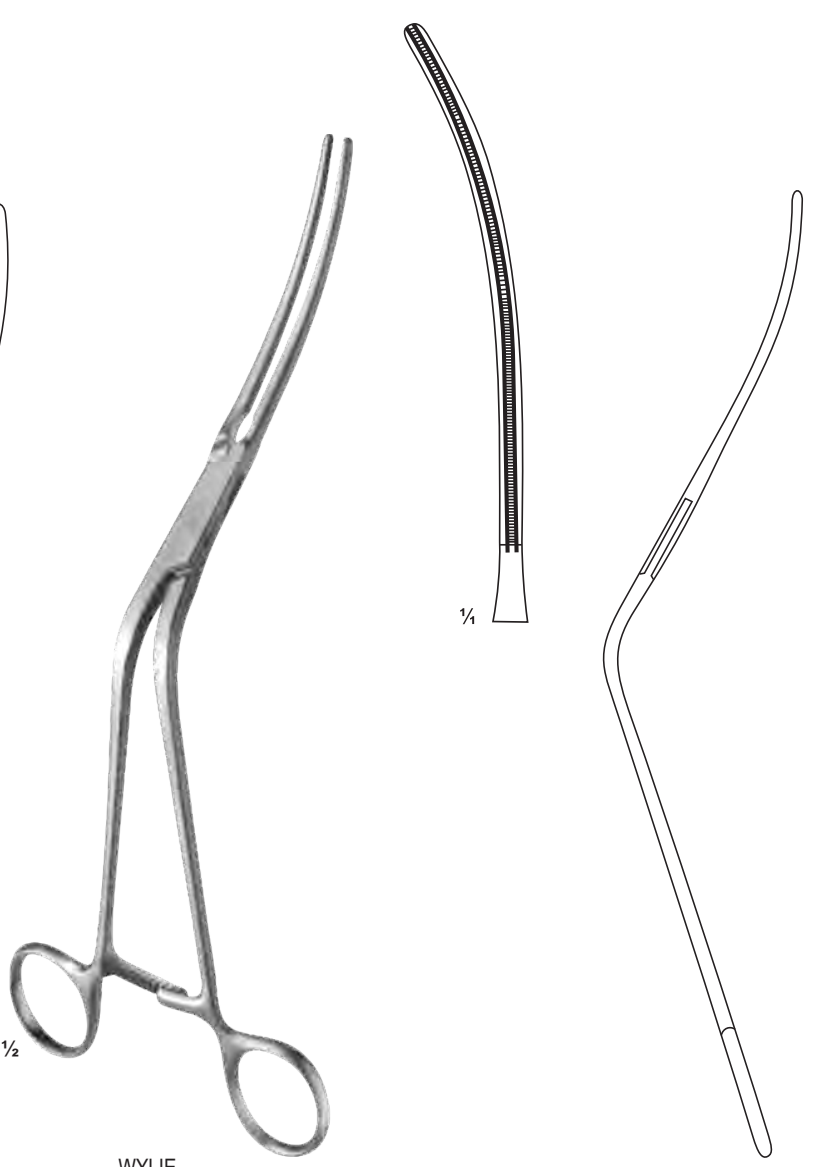

WYLIE
PQ-143
270 mm

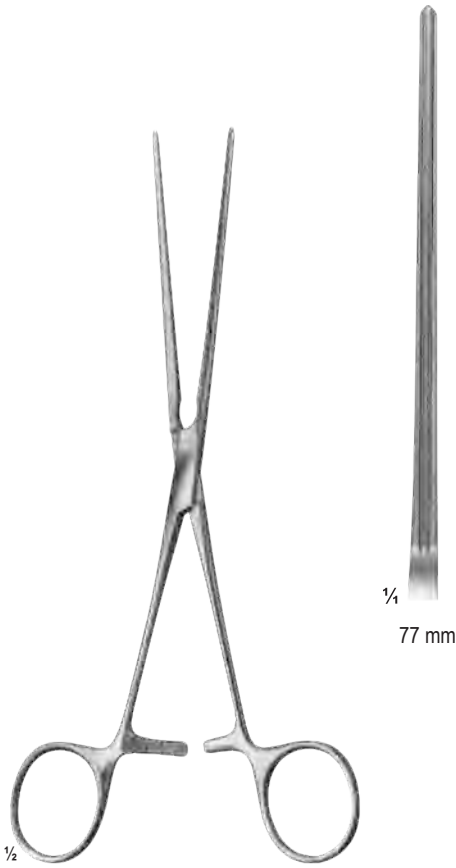

LELAND-JONES
PQ-144
195 mm

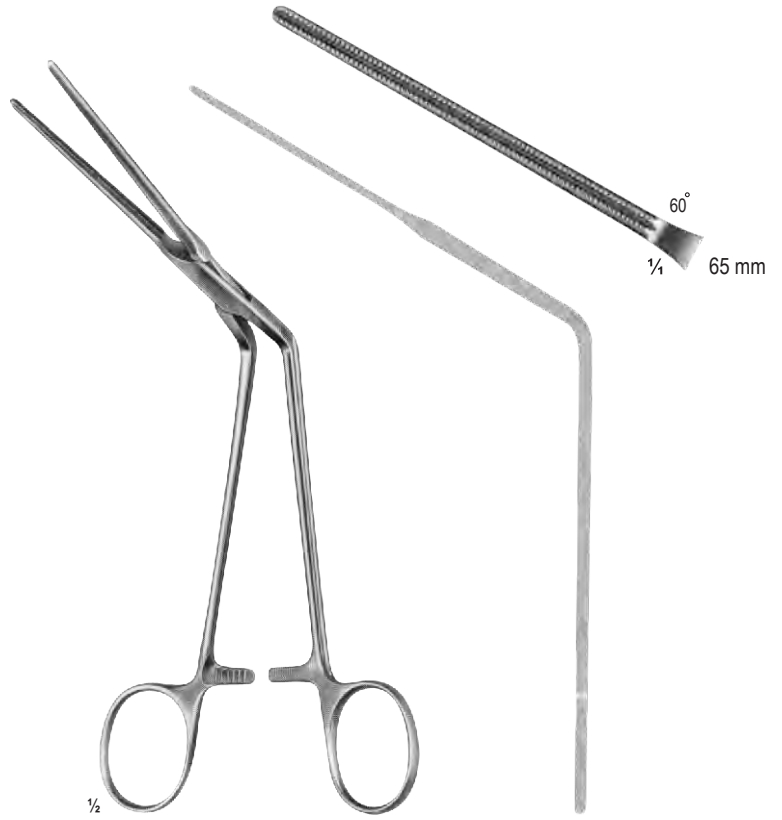

DE BAKEY
PQ-145
200 mm
Liac Clamp



COOLEY
PQ-146 120 mm
PQ-147 125 mm
PQ-148 125 mm

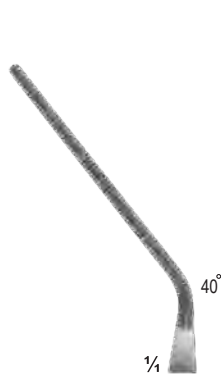

PQ-146
50 mm



PQ-147
50 mm



PQ-148
52 mm



ANEURYSM CLAMPS

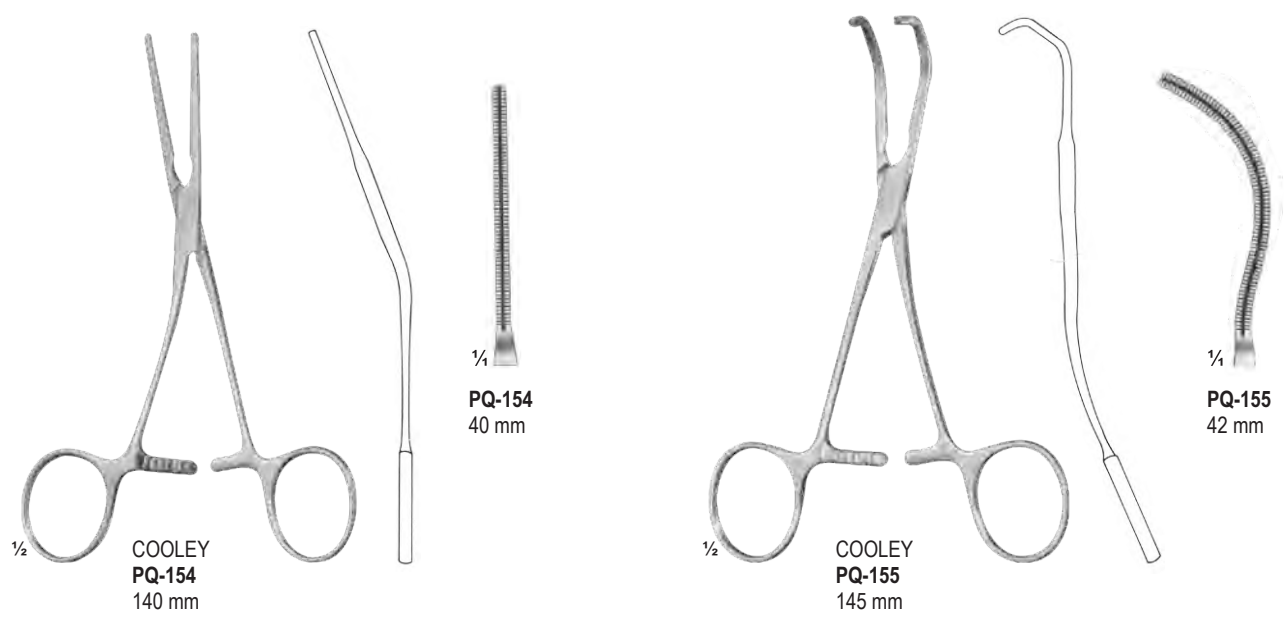
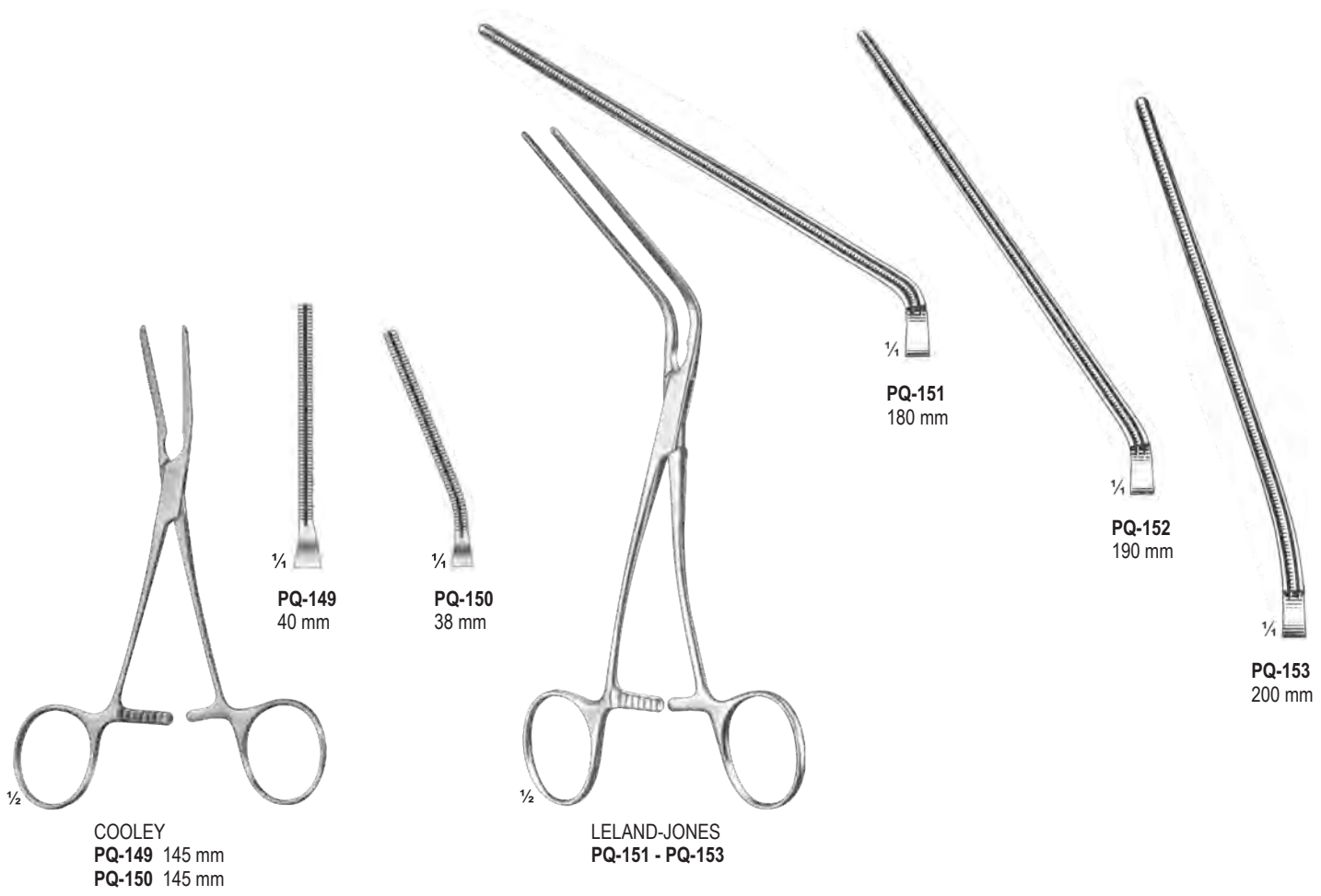

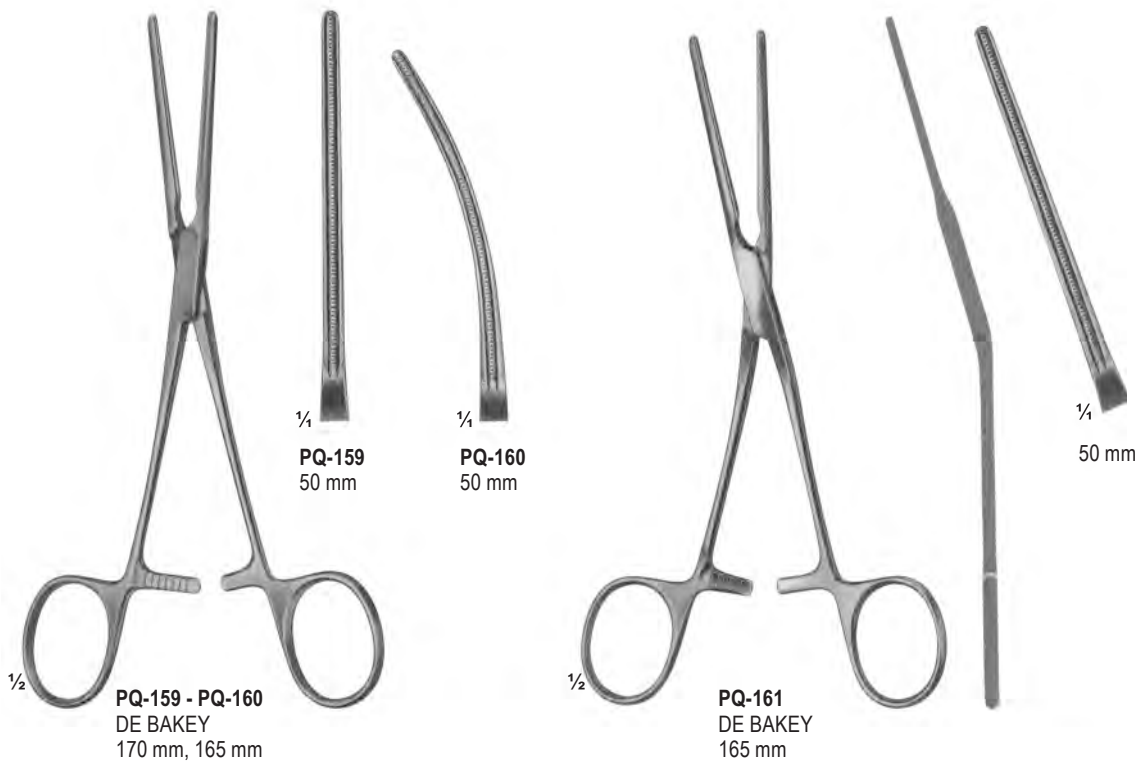
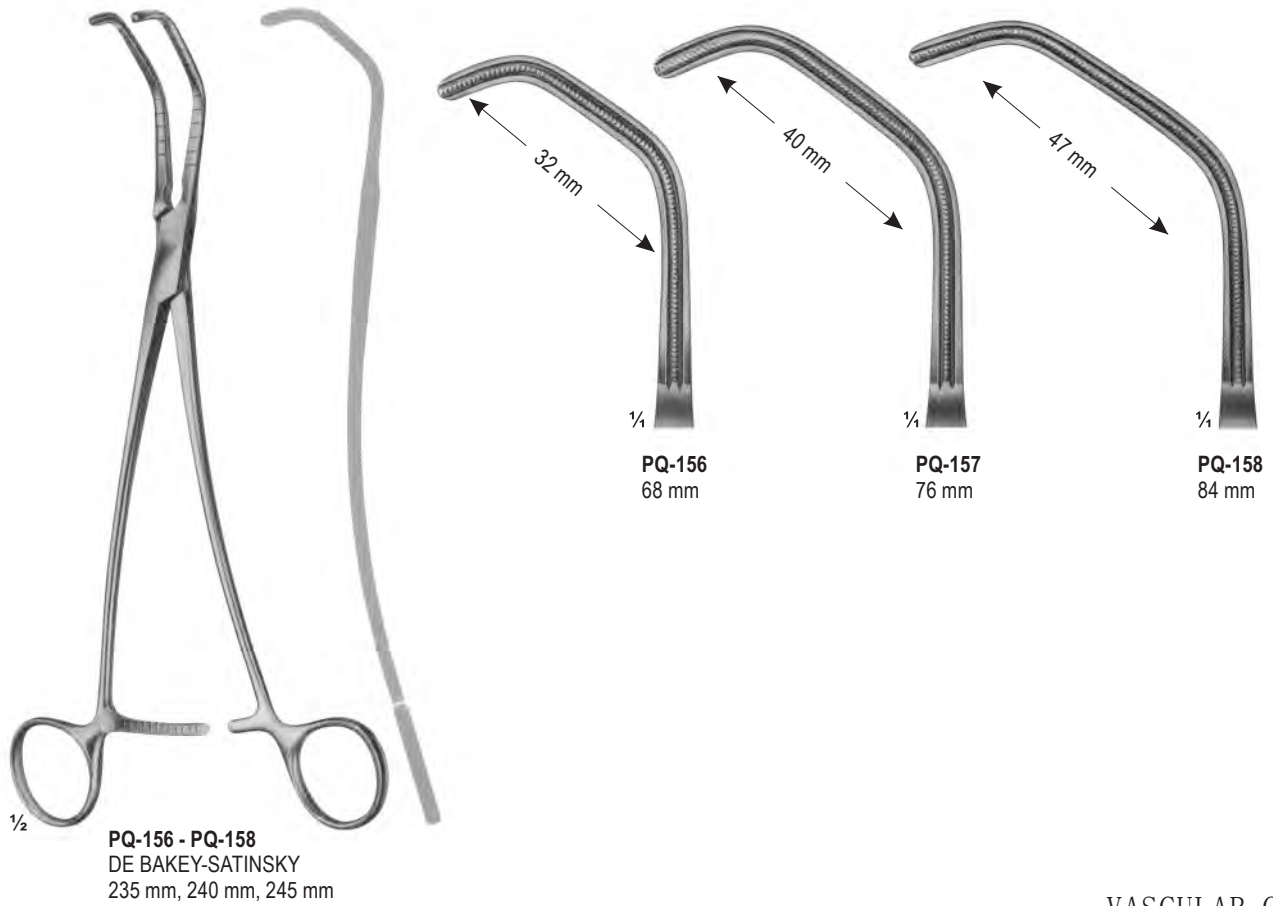



VENA-CAVA CLAMPS

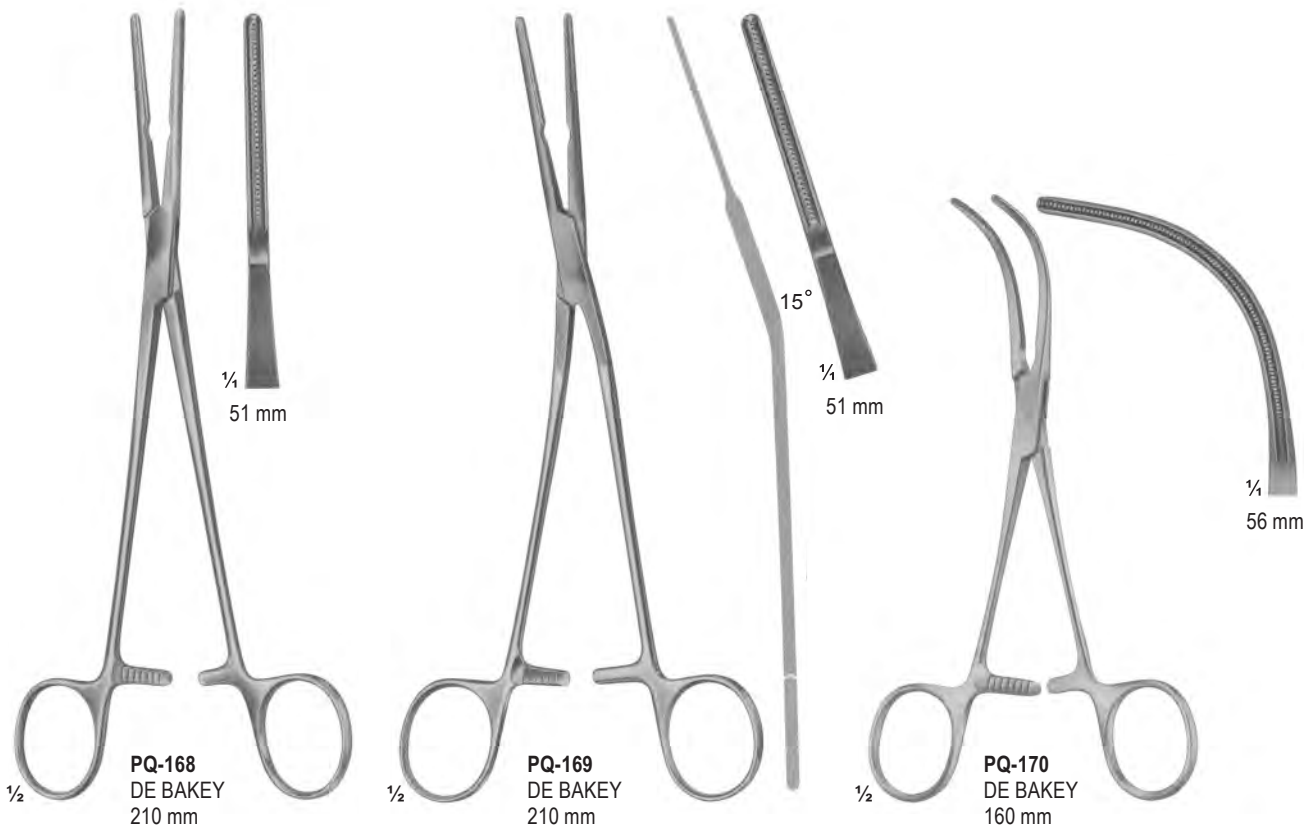
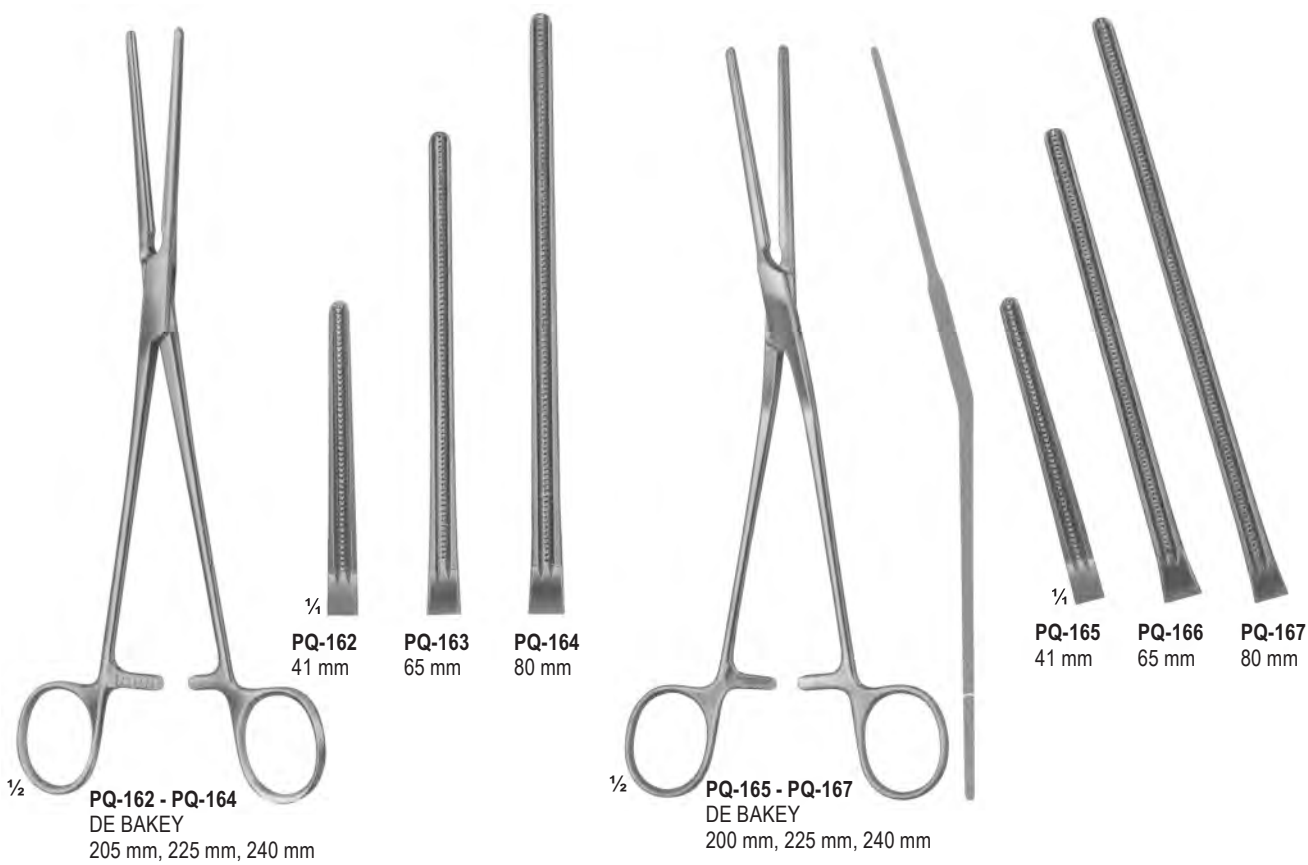

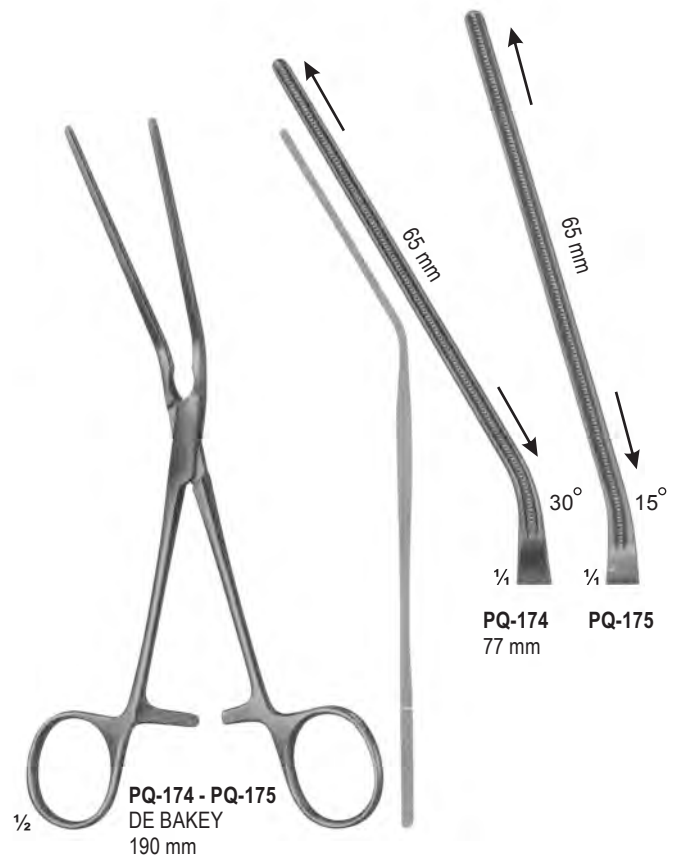
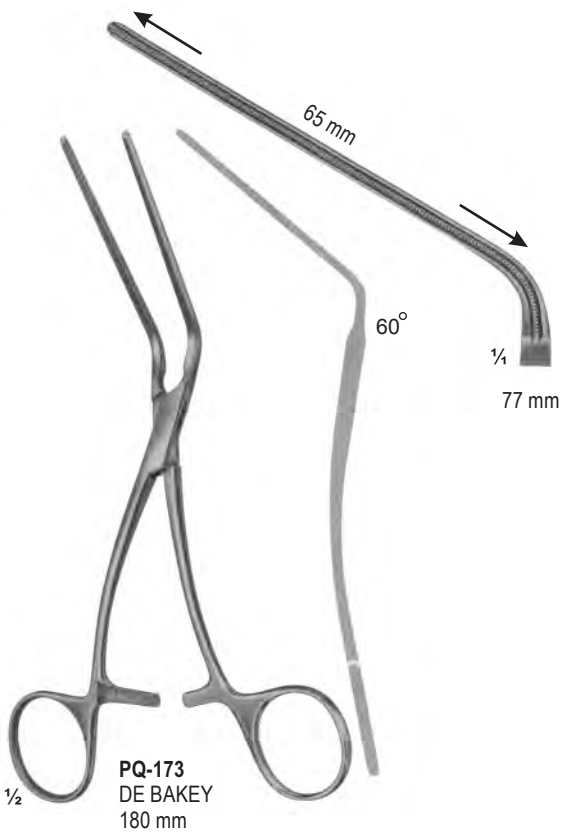
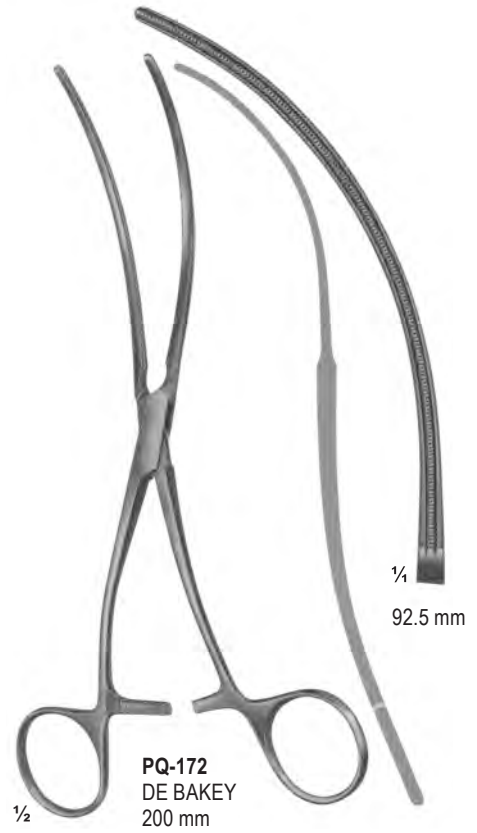
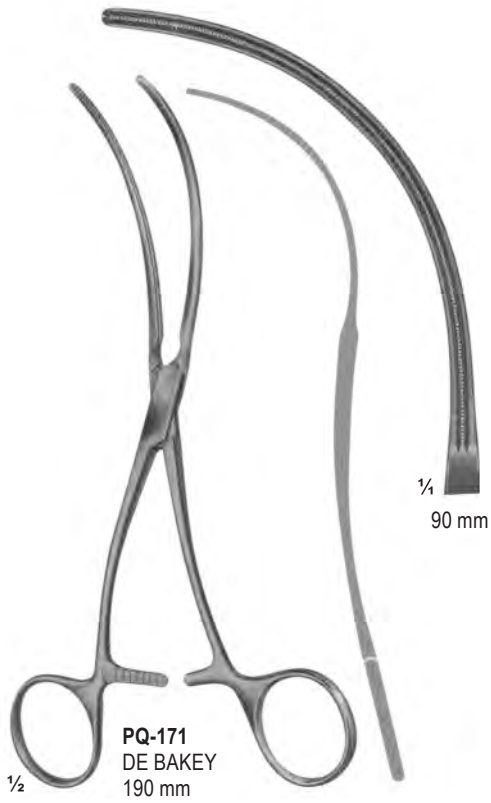



VENA-CAVA CLAMPS

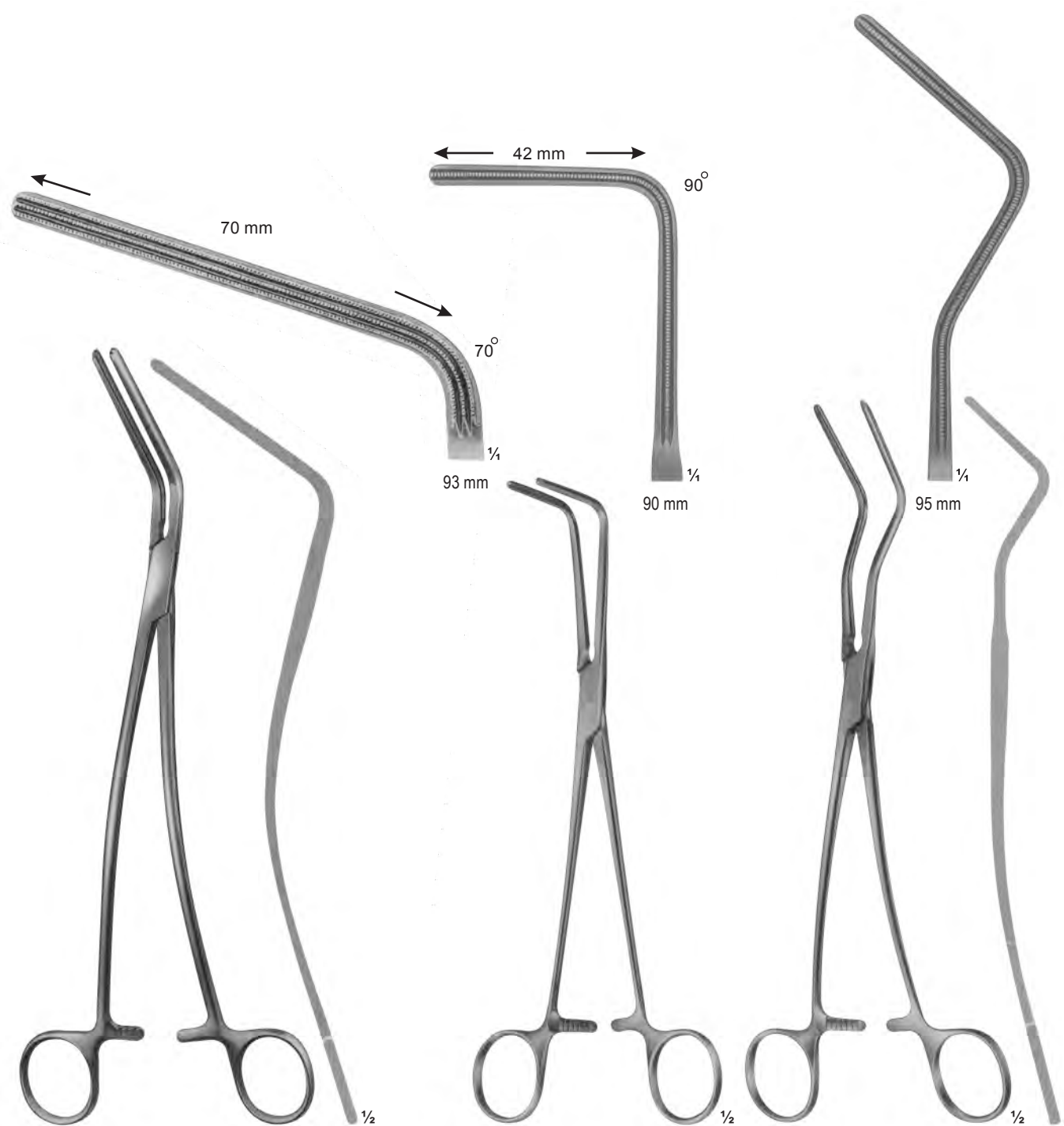

PQ-176
DE BAKEY
240 mm

PQ-177
LEES
220 mm

PQ-178
LEES
245 mm



AORTA CLAMPS

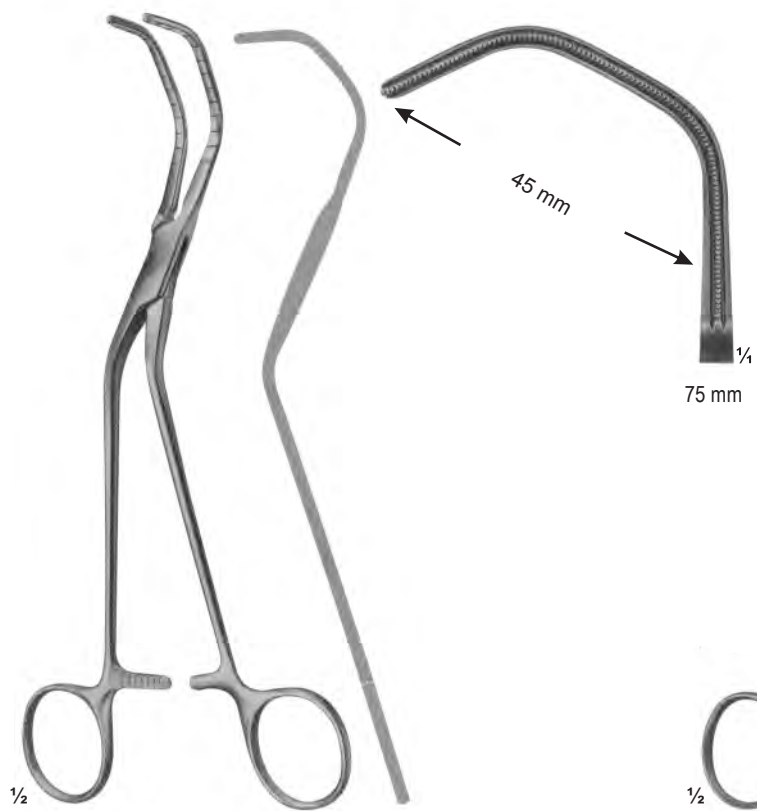

PQ-184
DIETRICH
210 mm

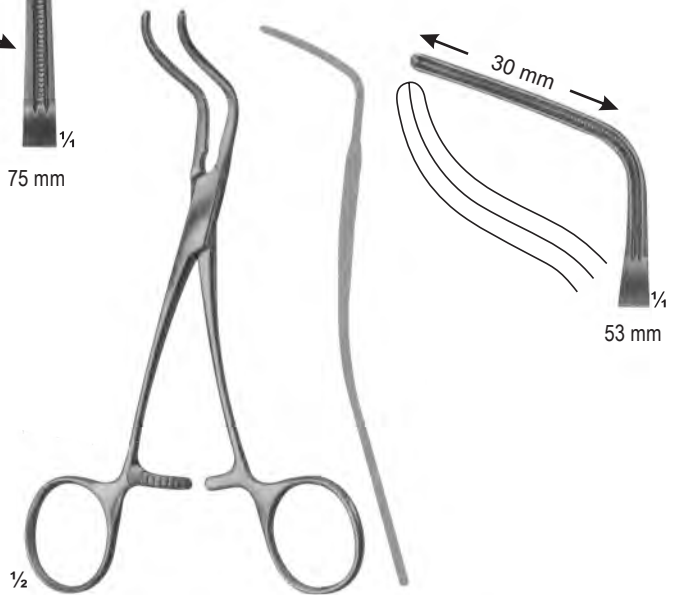

PQ-185
SUBRAMANIAN
155 mm

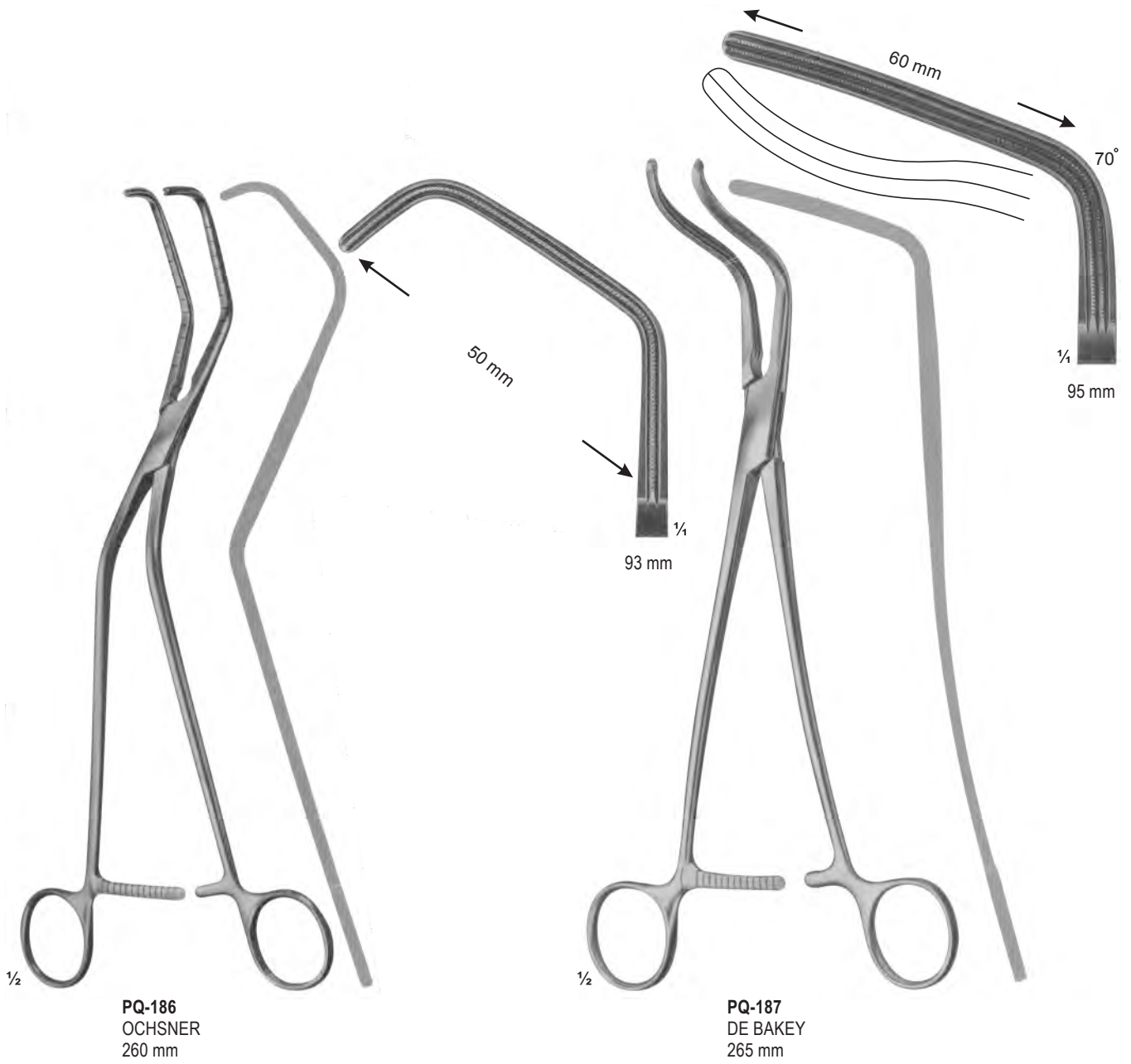



AORTA-ANASTOMOSIS CLAMPS

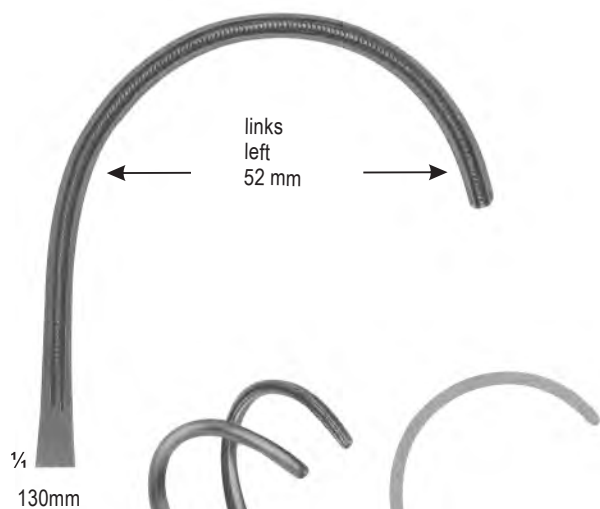

L
PQ-188
WEBER
265 mm

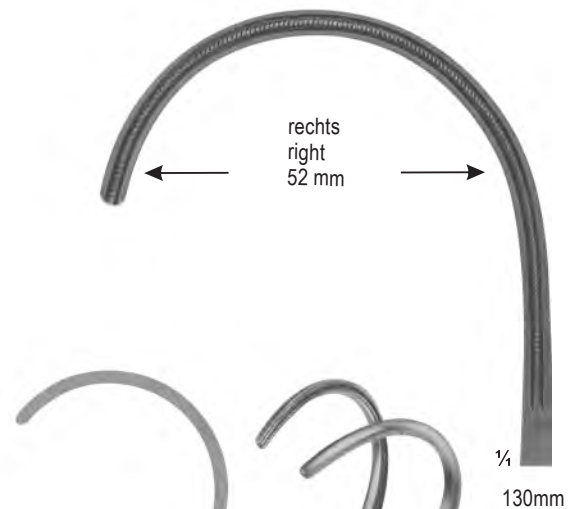

R
PQ-189
WEBER
265 mm



1/2 **PQ-190 - PQ-193**
DE BAKEY

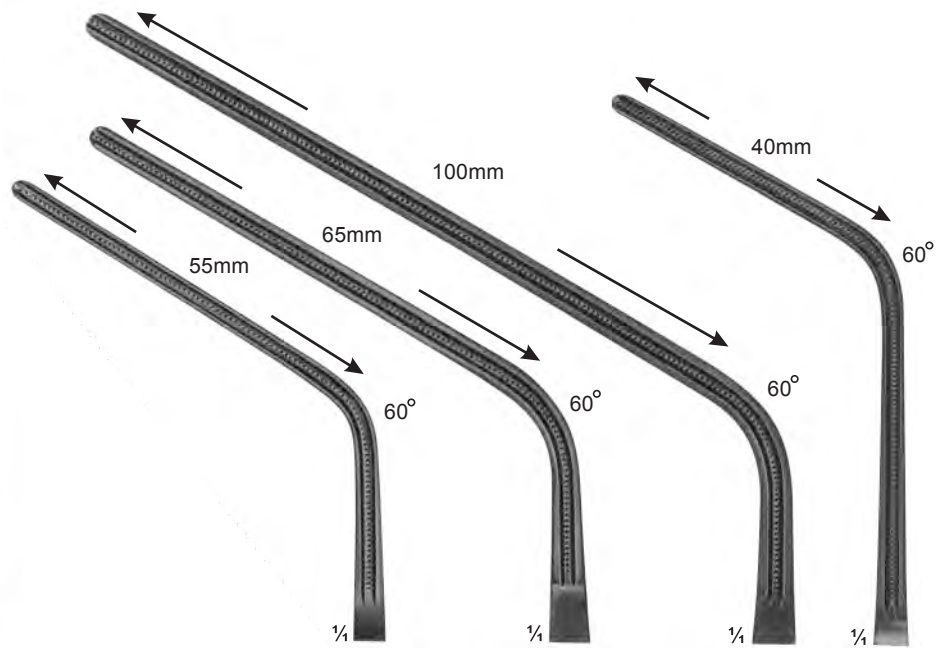

	PQ-190	PQ-191	PQ-192	PQ-193
Total Length:	230 mm	280 mm	305 mm	240 mm
Length of jaws:	85 mm	100 mm	135 mm	93 mm



1/2 **PQ-194 - PQ-197**
DE BAKEY

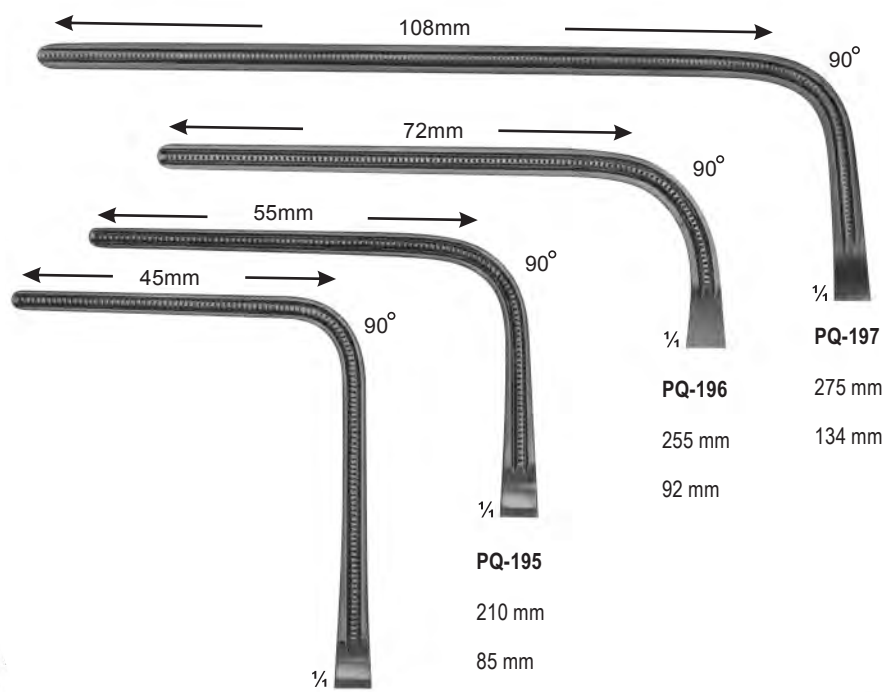

	PQ-194	PQ-195	PQ-196	PQ-197
Total Length:	225 mm	210 mm	255 mm	275 mm
Length of jaws:	93 mm	85 mm	92 mm	134 mm



RING HANDLE BULLDOG CLAMPS

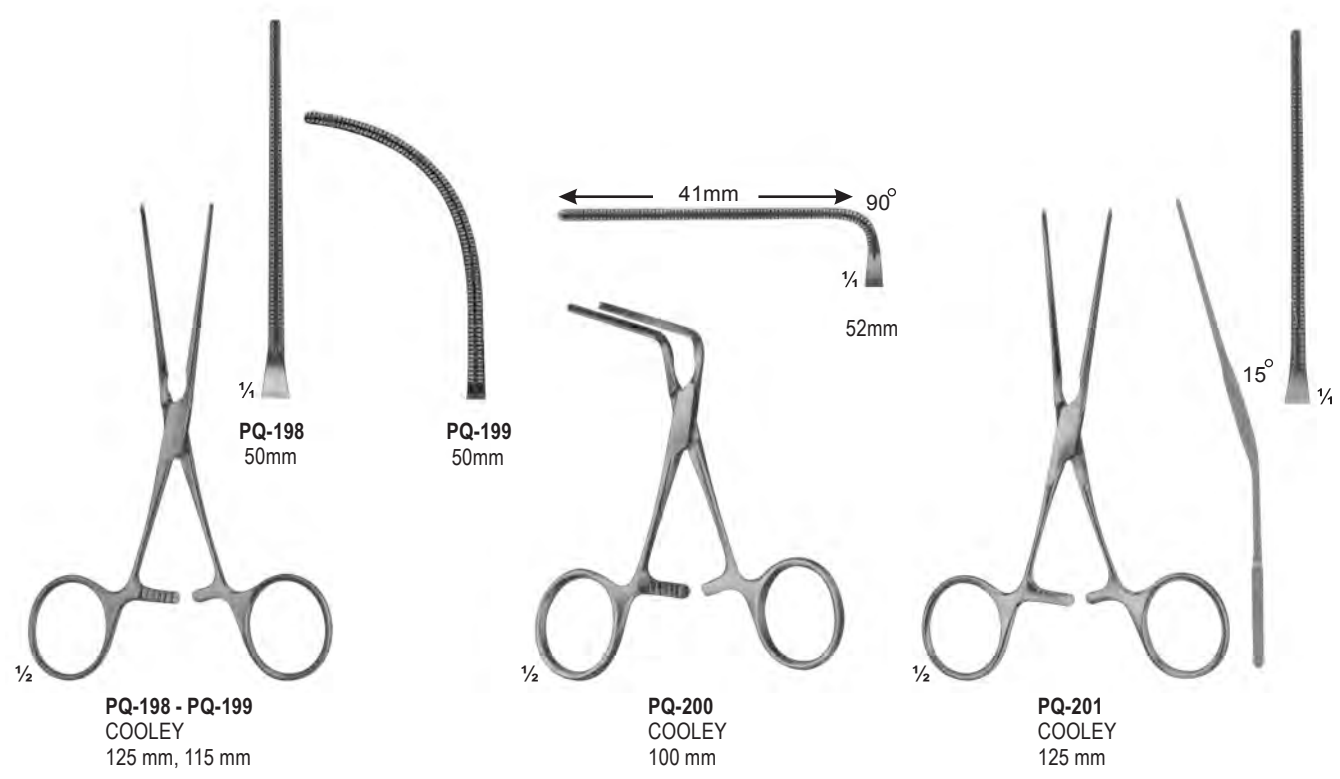

ANASTOMOSIS CLAMPS, PEDIATRIC PATTERNS

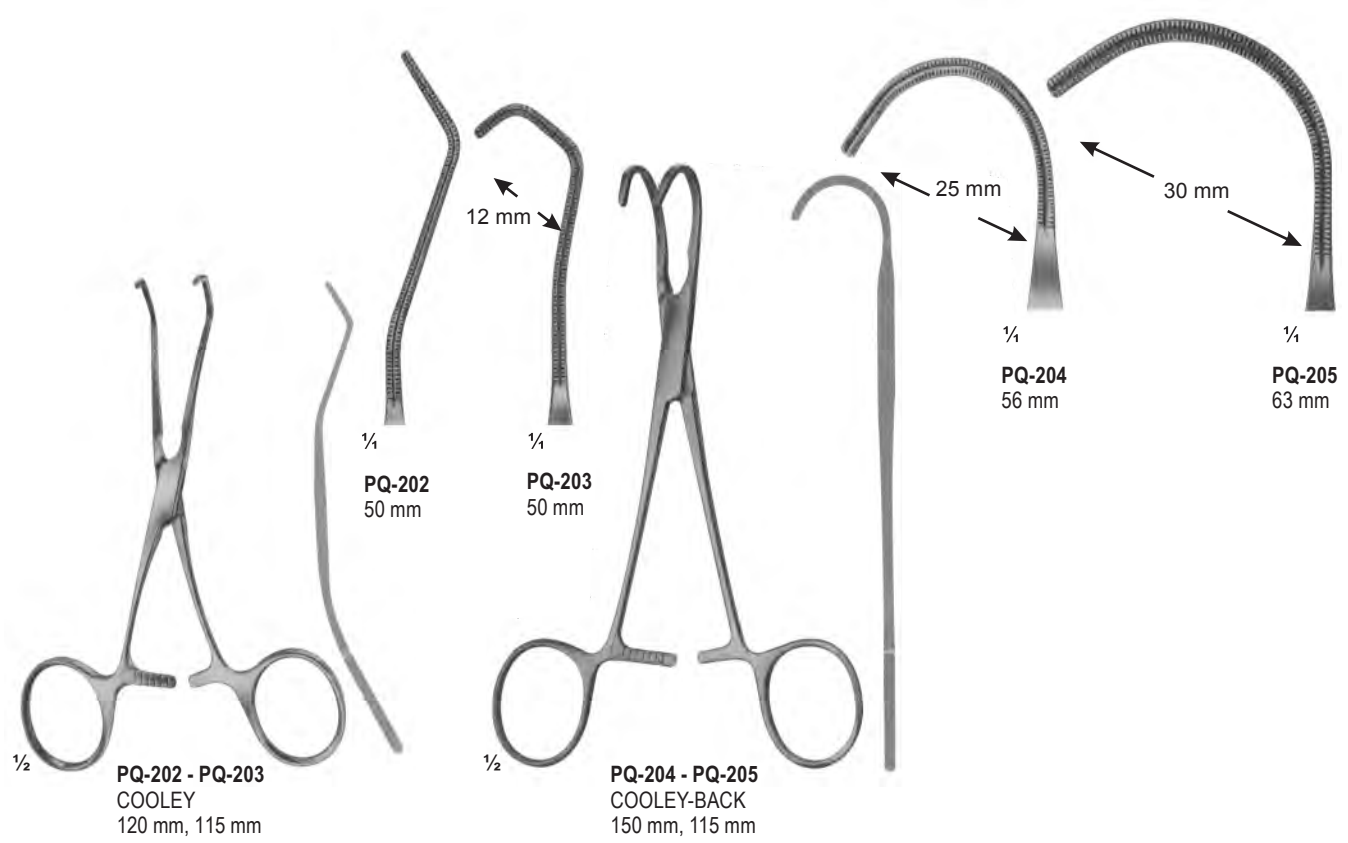

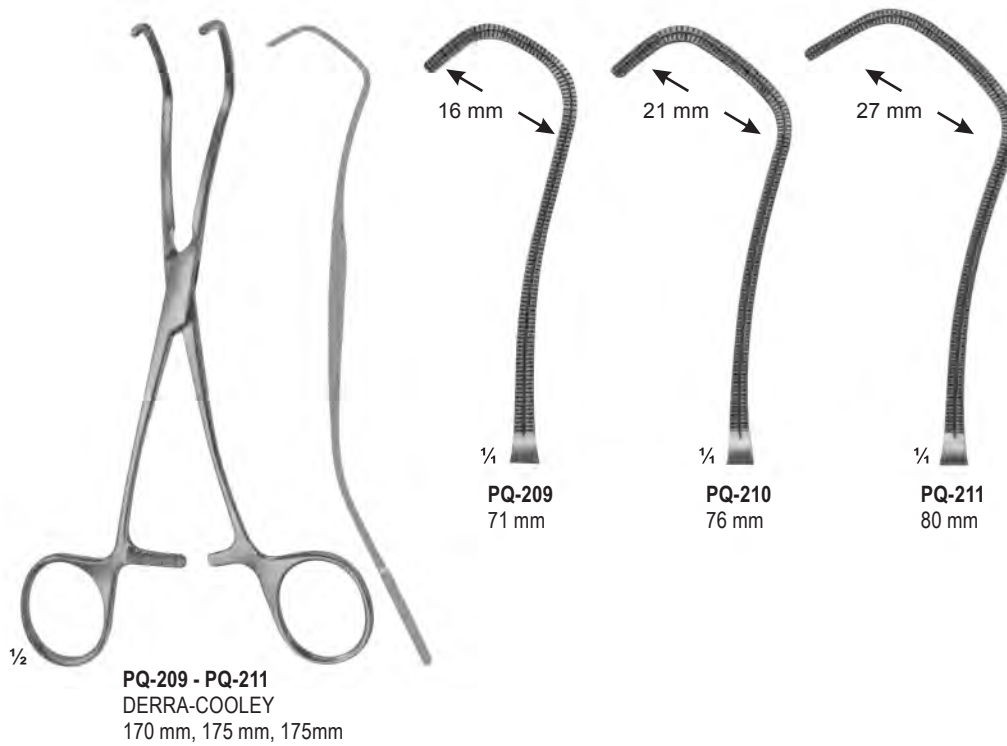
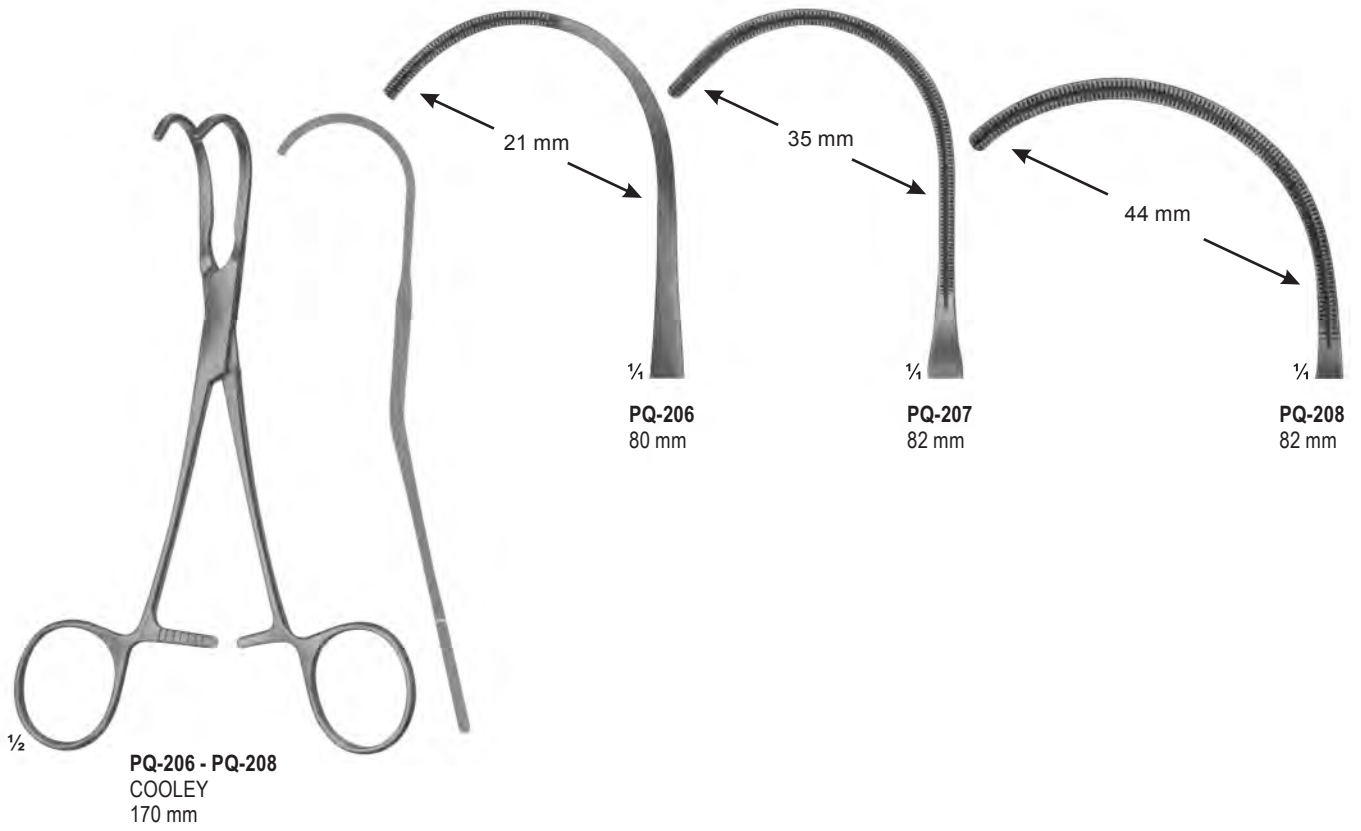



AORTA-ANASTOMOSIS CLAMPS

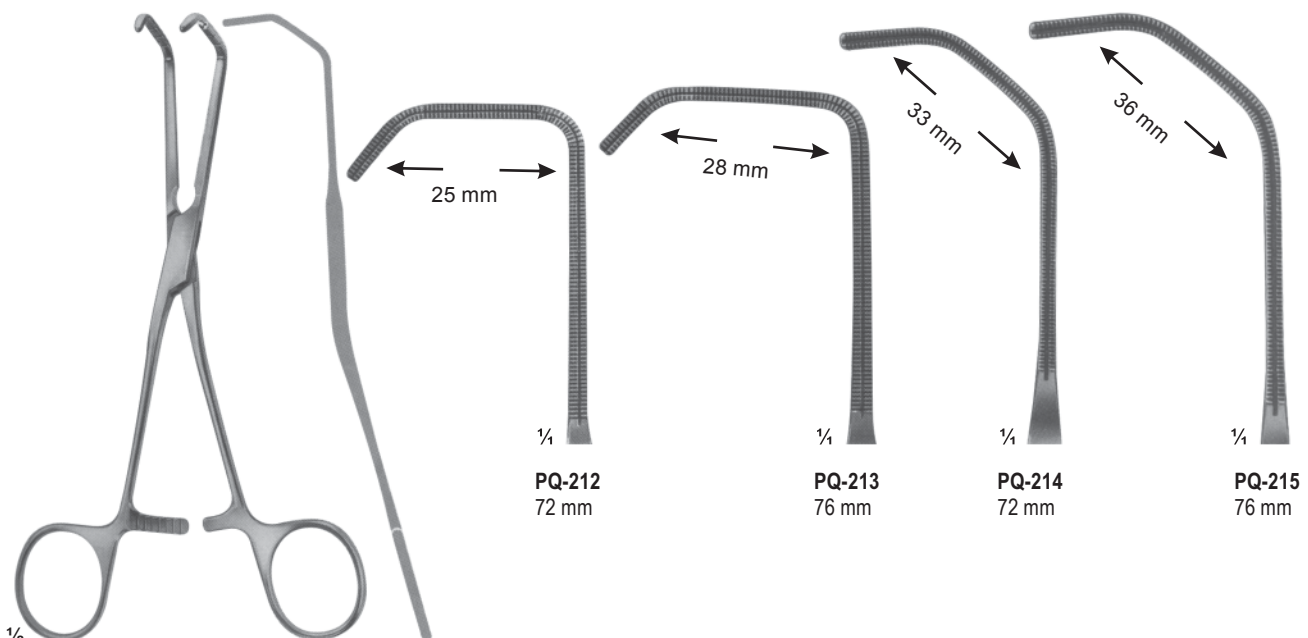

PQ-212
72 mm

PQ-213
76 mm

PQ-214
72 mm

PQ-215
76 mm

PQ-212 - PQ-215
COOLEY
165 mm, 165 mm
175 mm, 180 mm

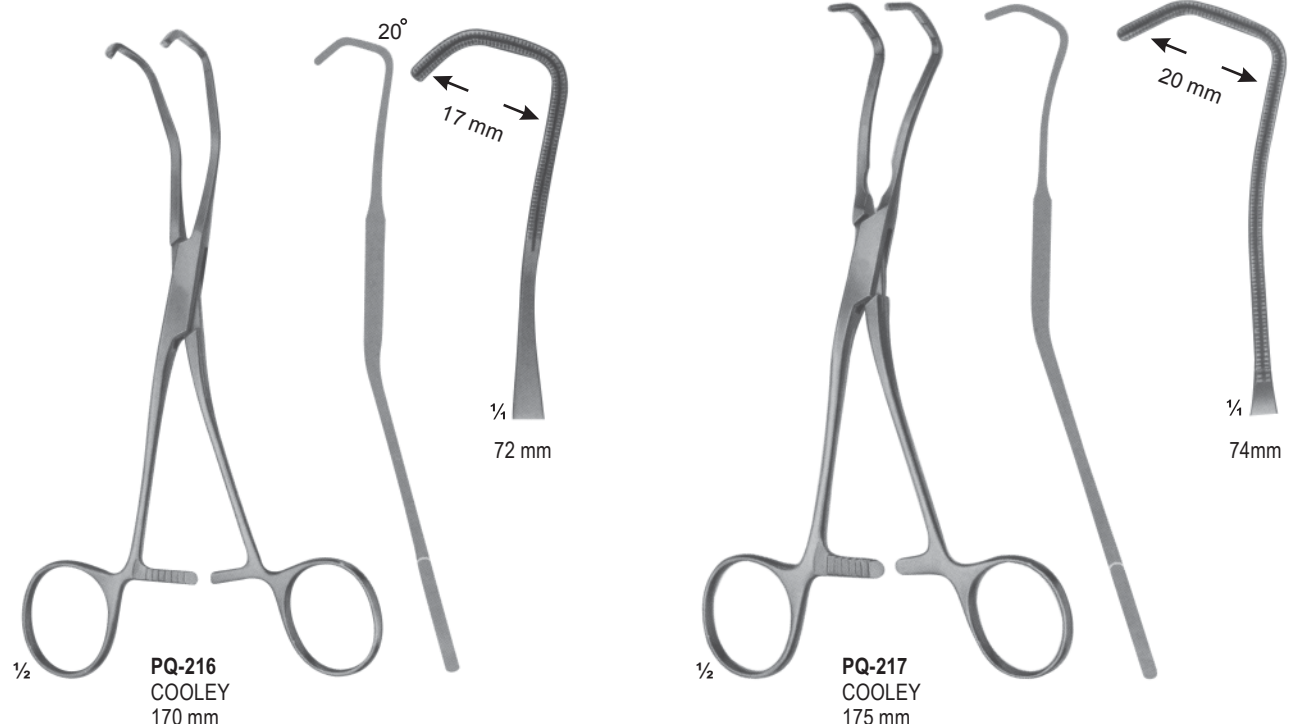

PQ-216
72 mm

PQ-217
74 mm

PQ-216
COOLEY
170 mm

PQ-217
COOLEY
175 mm

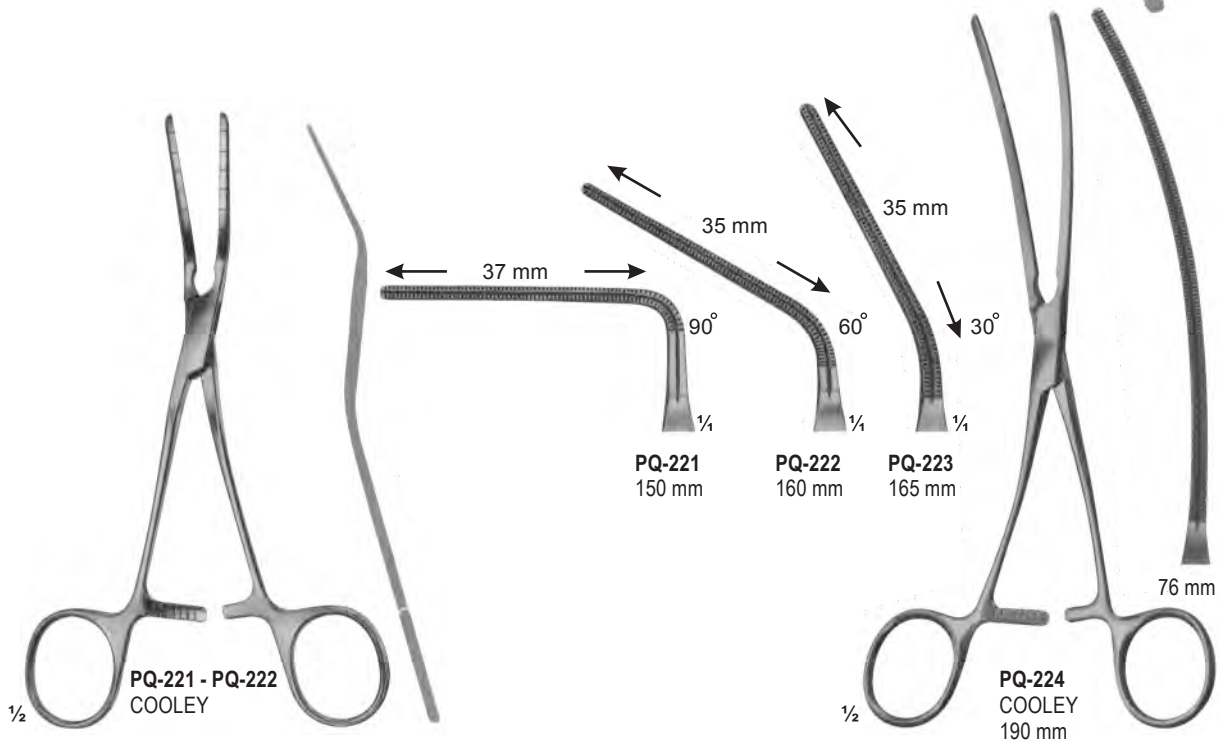
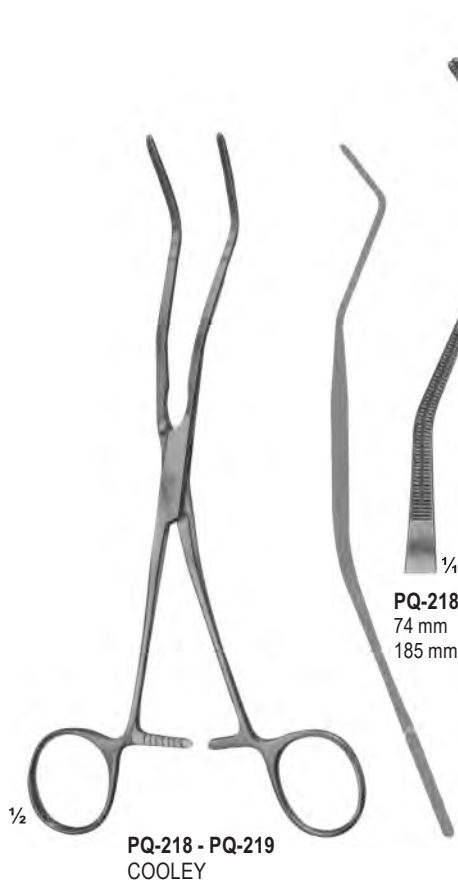



AORTA-ANASTOMOSIS CLAMPS

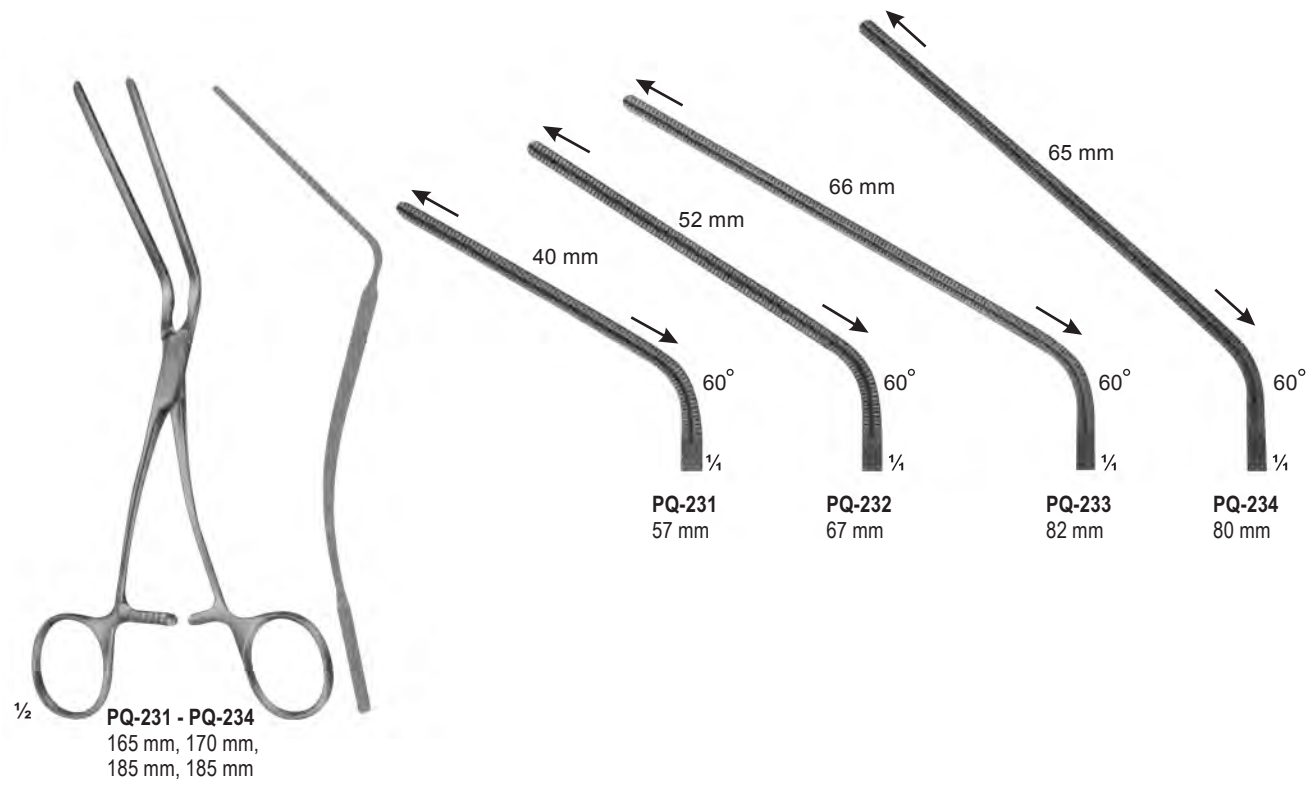
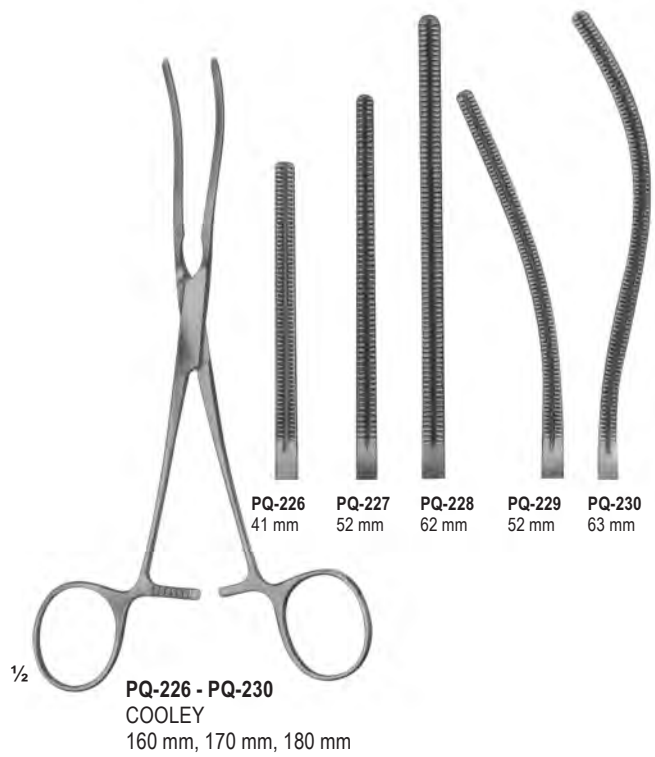
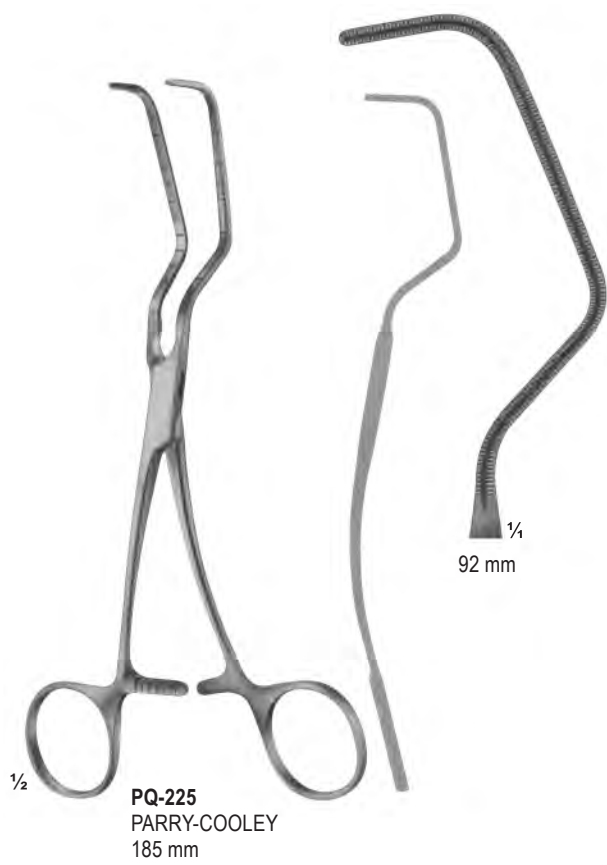



1/2
DARDIK
PQ-235 150 mm
PQ-236 150 mm
PQ-237 150 mm
PQ-238 145 mm
PQ-239 130 mm

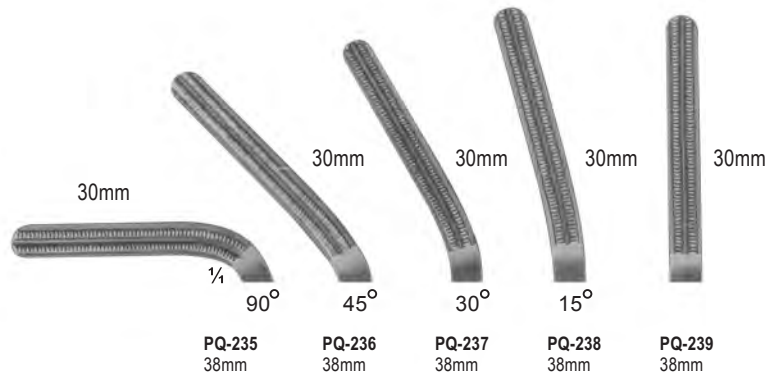

1/2
DARDIK
PQ-235 170 mm
PQ-236 170 mm
PQ-237 170 mm
PQ-238 160 mm
PQ-239 135 mm

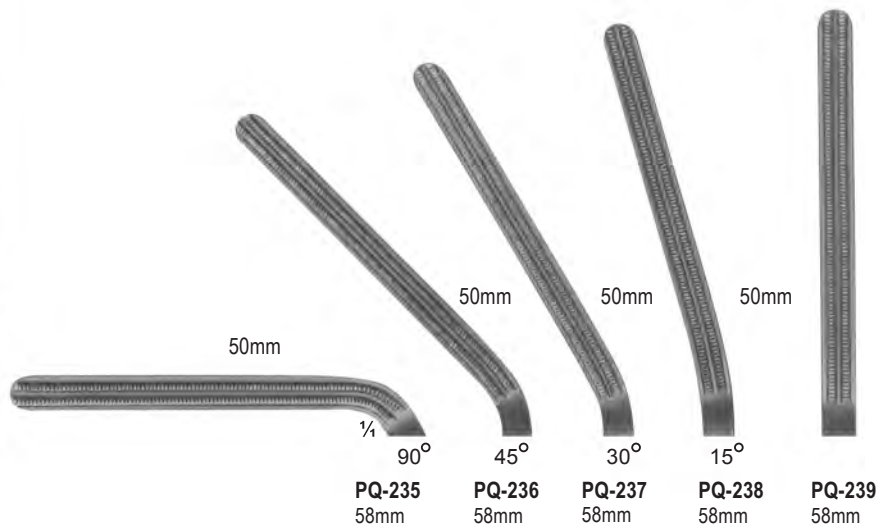



MULTI-PURPOSE CLAMPS



PQ-240
WILLIAMS
160 mm



PQ-241
TUTTLE
230 mm



PQ-242
NELSON
230 mm

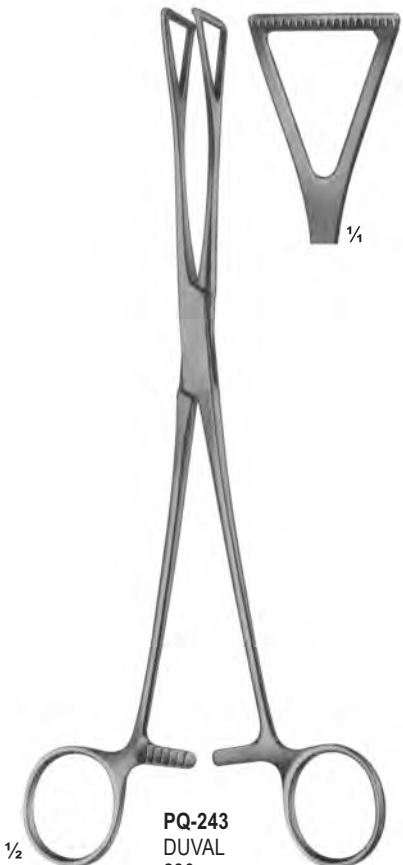

PQ-243
DUVAL
230 mm

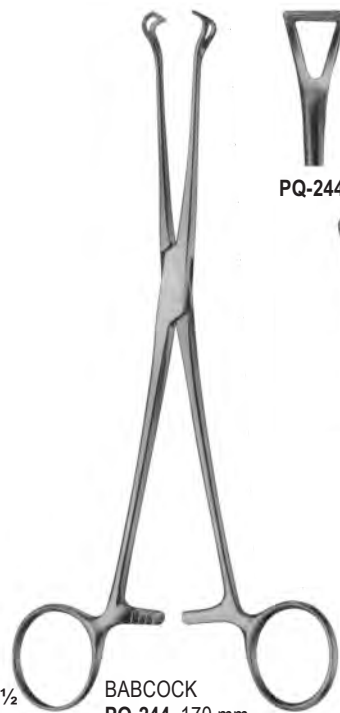

BABCOCK
PQ-244 170 mm
PQ-245 215 mm
PQ-246 220 mm

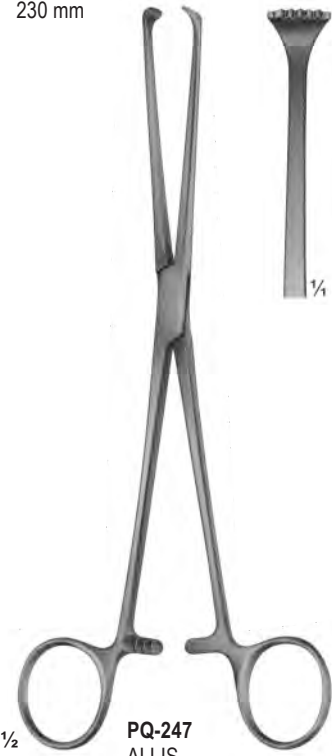
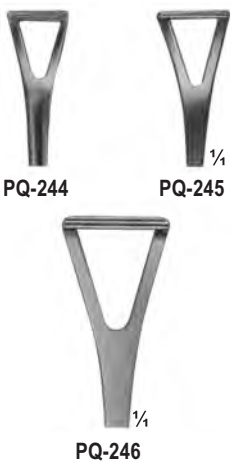

PQ-247
ALLIS
220 mm

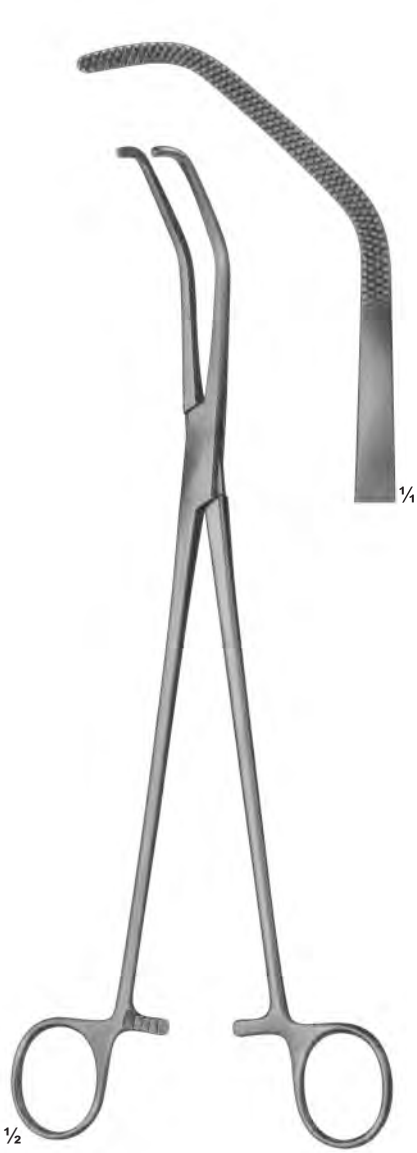

PQ-248
SATINSKY
265 mm



PQ-249
SATINSKY
265 mm

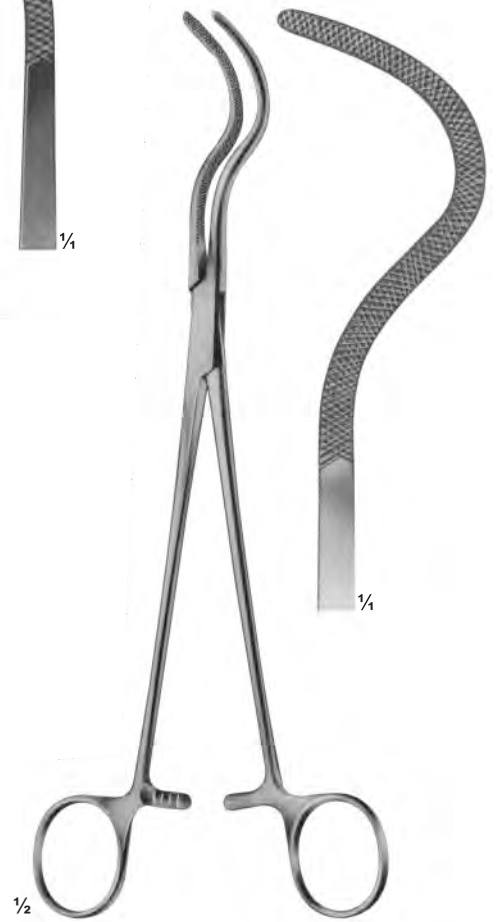

PQ-250
HARKEN
240 mm



CAROTID CLAMPS, VASCULAR CLAMPS

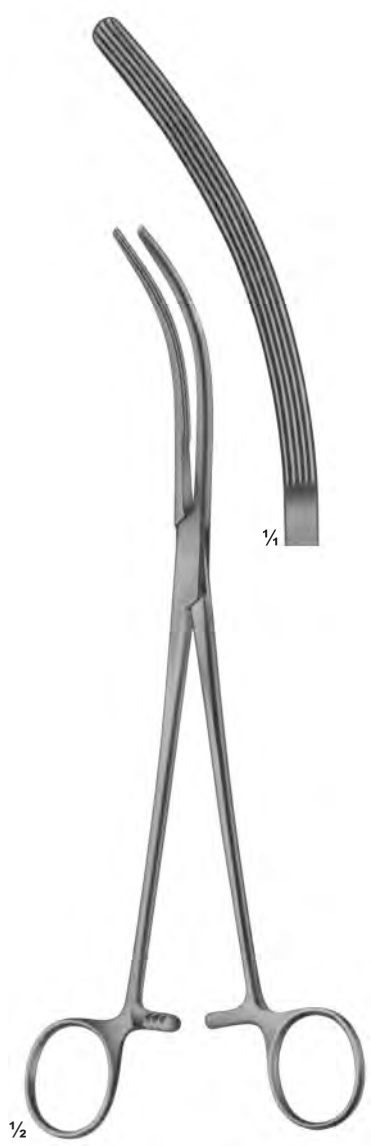

PQ-251
CRAFOORD-SELLORS
240 mm

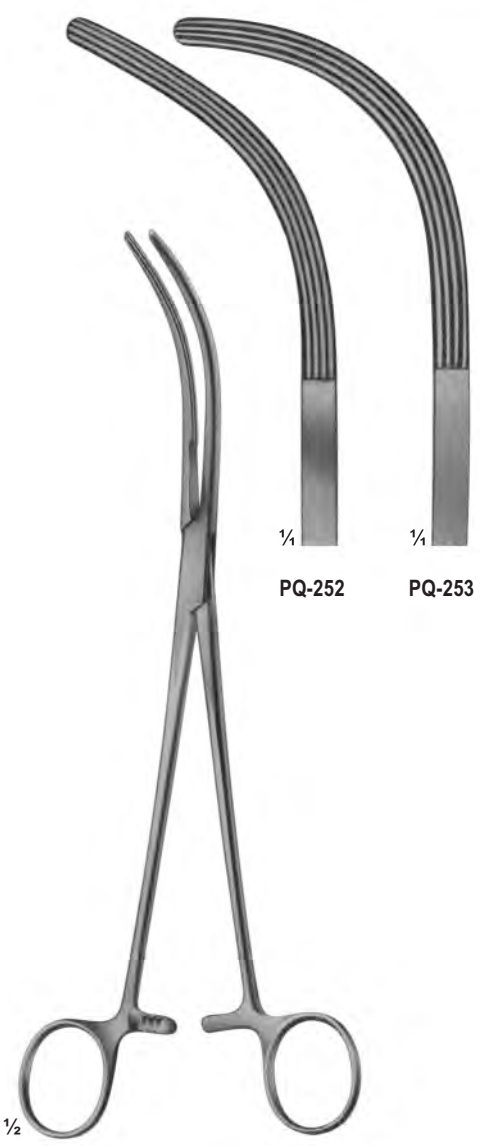

PQ-252 - PQ-253
CRAFOORD
240 mm



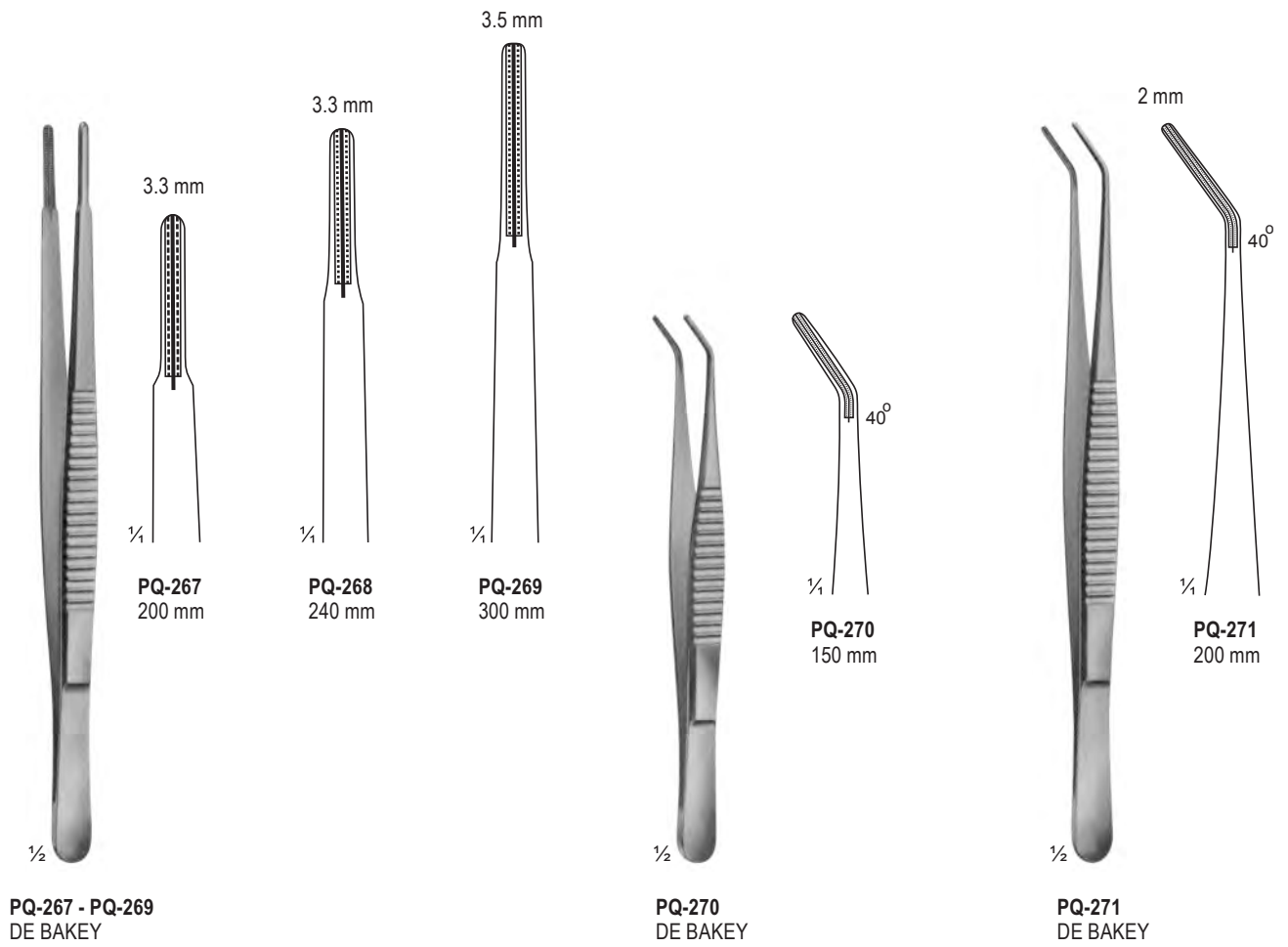

ULTRA - LIGHT - FORCEPS, DISSECTING FORCEPS

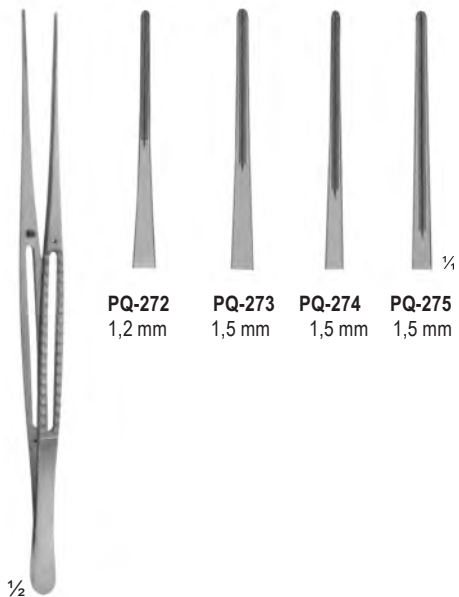

PQ-272 1,2 mm
PQ-273 1,5 mm
PQ-274 1,5 mm
PQ-275 1,5 mm

PQ-272 150 mm
PQ-273 200 mm
PQ-274 240 mm
PQ-275 300 mm

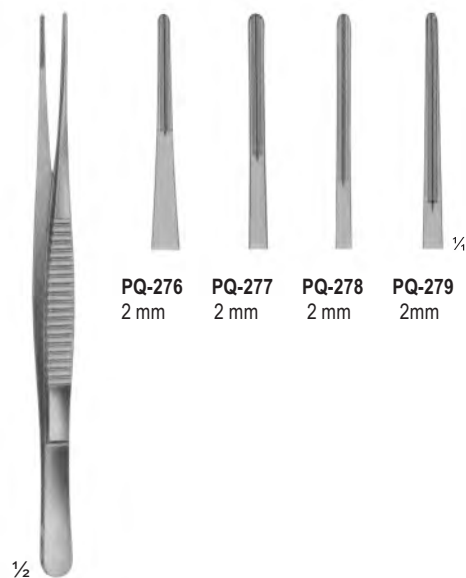

PQ-276 2 mm
PQ-277 2 mm
PQ-278 2 mm
PQ-279 2mm

DE BAKEY
PQ-276 150 mm
PQ-277 200 mm
PQ-278 240 mm
PQ-279 300 mm

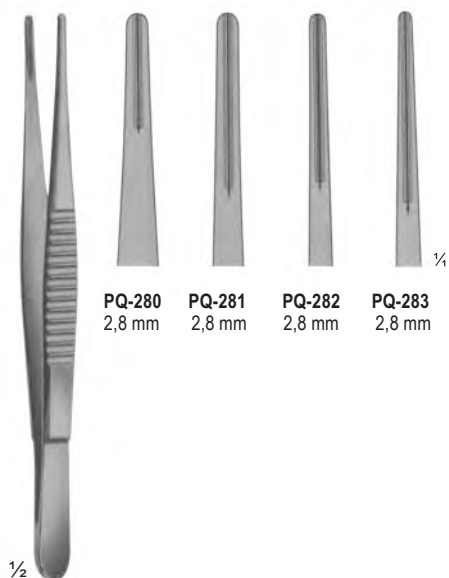

PQ-280 2,8 mm
PQ-281 2,8 mm
PQ-282 2,8 mm
PQ-283 2,8 mm

DE BAKEY
PQ-280 150 mm
PQ-281 200 mm
PQ-282 240 mm
PQ-283 300 mm

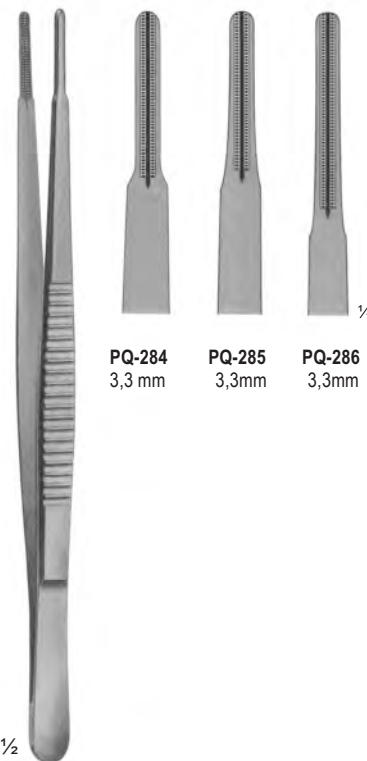

PQ-284 3,3 mm
PQ-285 3,3mm
PQ-286 3,3mm

DE BAKEY
PQ-284 200 mm
PQ-285 240 mm
PQ-286 300 mm

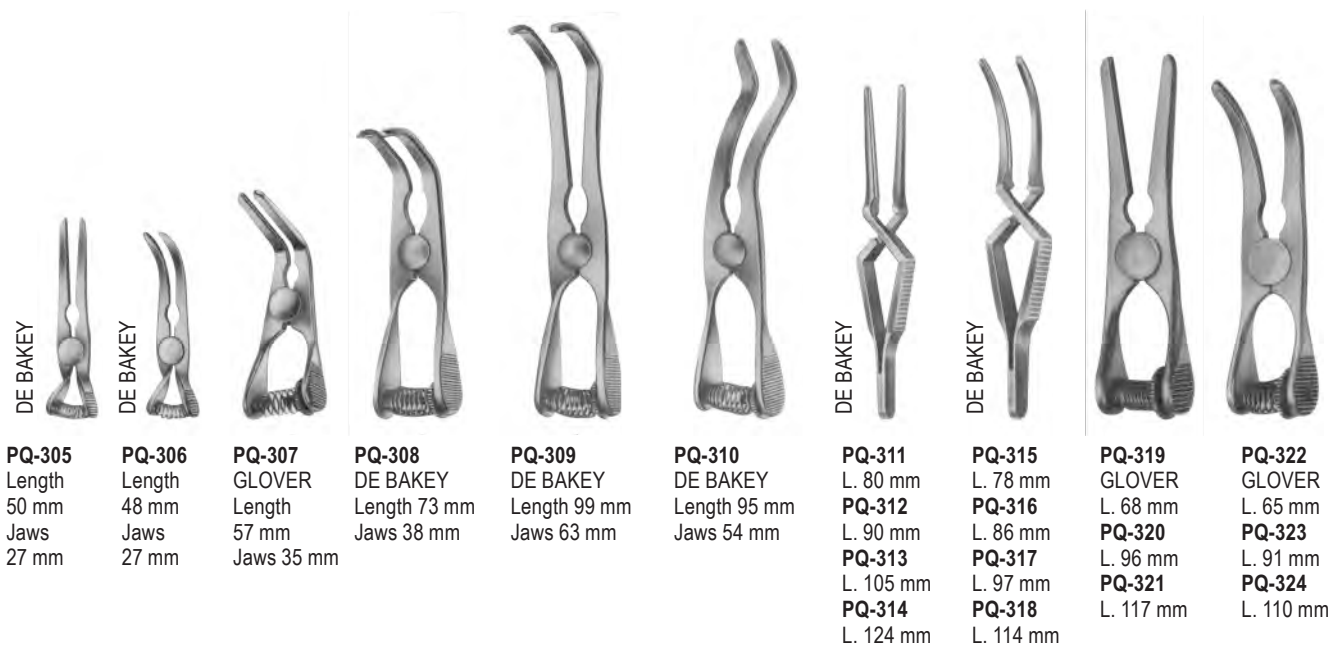
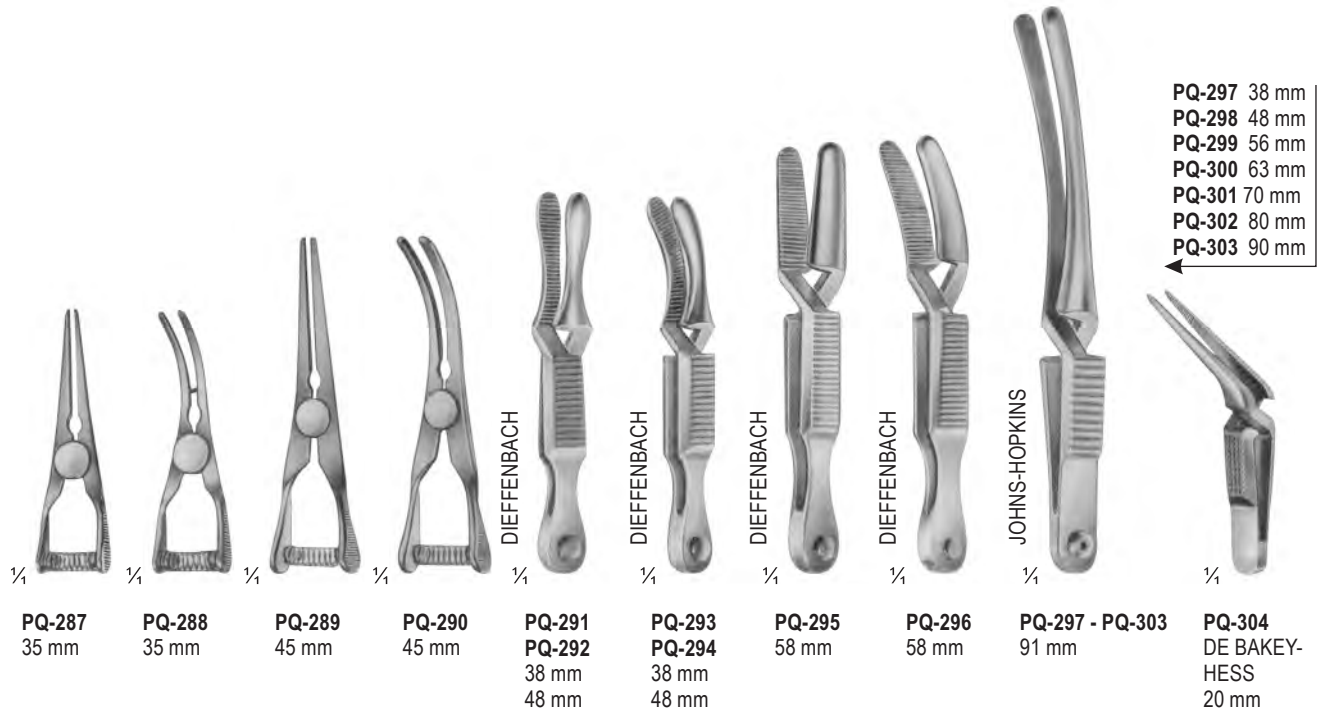



VASCULAR DILATORS

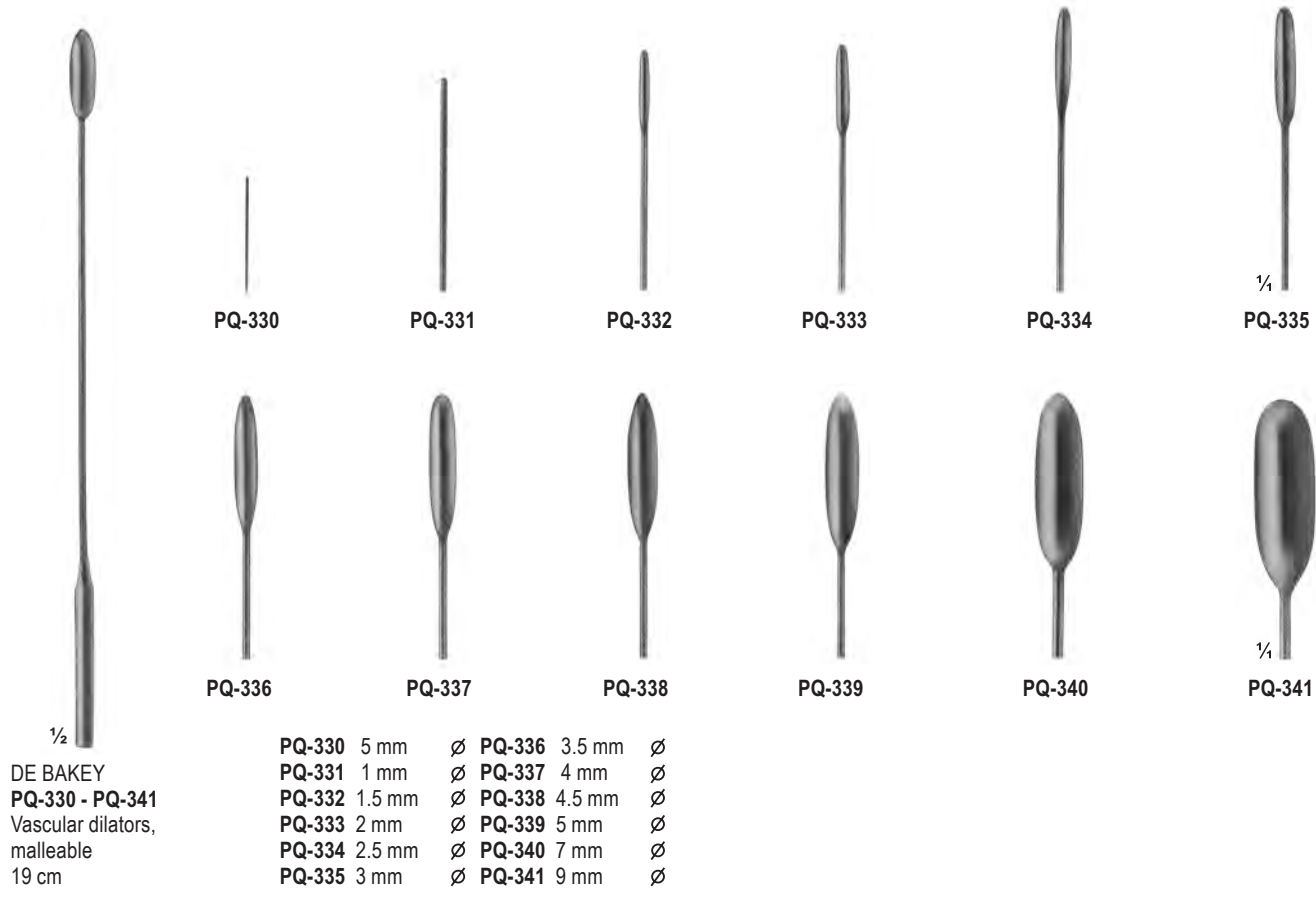
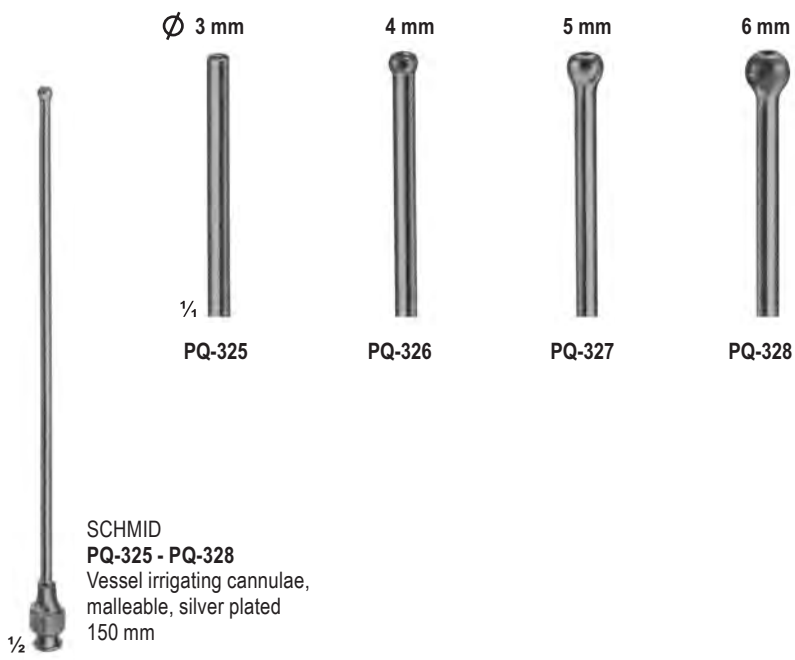

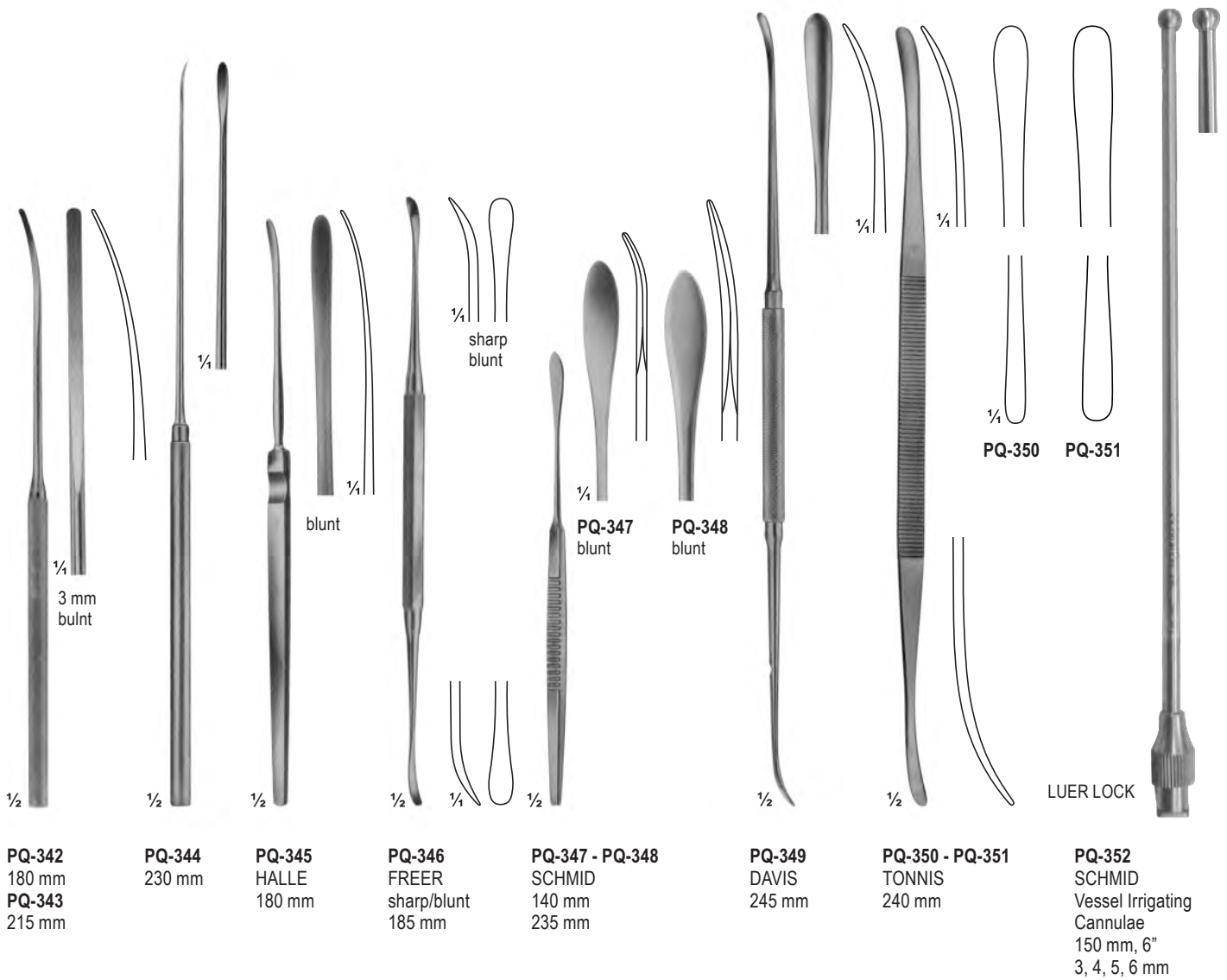



INTIMA SPATULAS, VASCULAR DILATORS

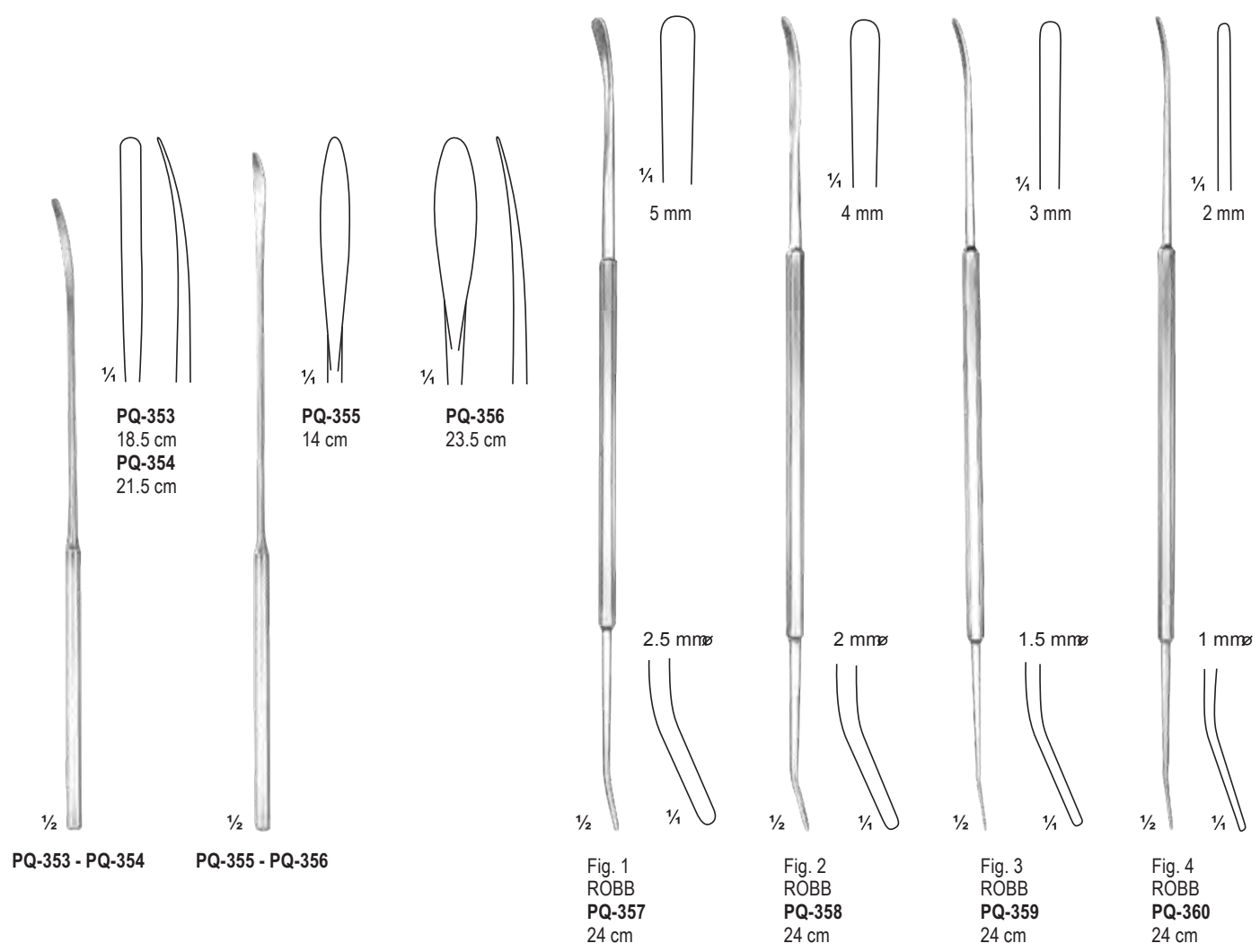



CRILE
PQ-361
20 cm



CRILE
PQ-362
20.5 cm



PQ-363 - PQ-366
26 cm

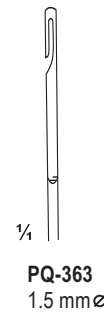

PQ-363
1.5 mm \varnothing

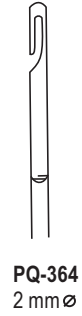

PQ-364
2 mm \varnothing

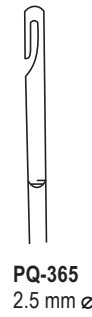

PQ-365
2.5 mm \varnothing

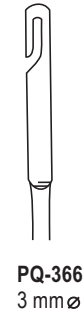

PQ-366
3 mm \varnothing

NERVE HOOKLETS, TOURNIQUETS



PQ-367
2 mm



PQ-368
3 mm



PQ-369
5 mm



PQ-370
6 mm



PQ-371
7 mm



PQ-372
8.5 mm

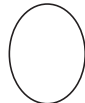

PQ-373
10 mm

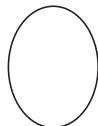

PQ-374
12 mm



PQ-375
14mm



1/4

PQ-367 - PQ-375
Endarterectomy strippers
55 cm



1/2

PQ-376
Handle for
11 cm



1/2

RUMEL-BELBONT
PQ-377 - PQ-378
32.5 cm
PQ-377 - 4 mm ϕ
PQ-378 - 6.4 mm ϕ

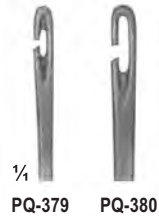

1/4

PQ-379

PQ-380

PQ-379 - PQ-380
Guide only

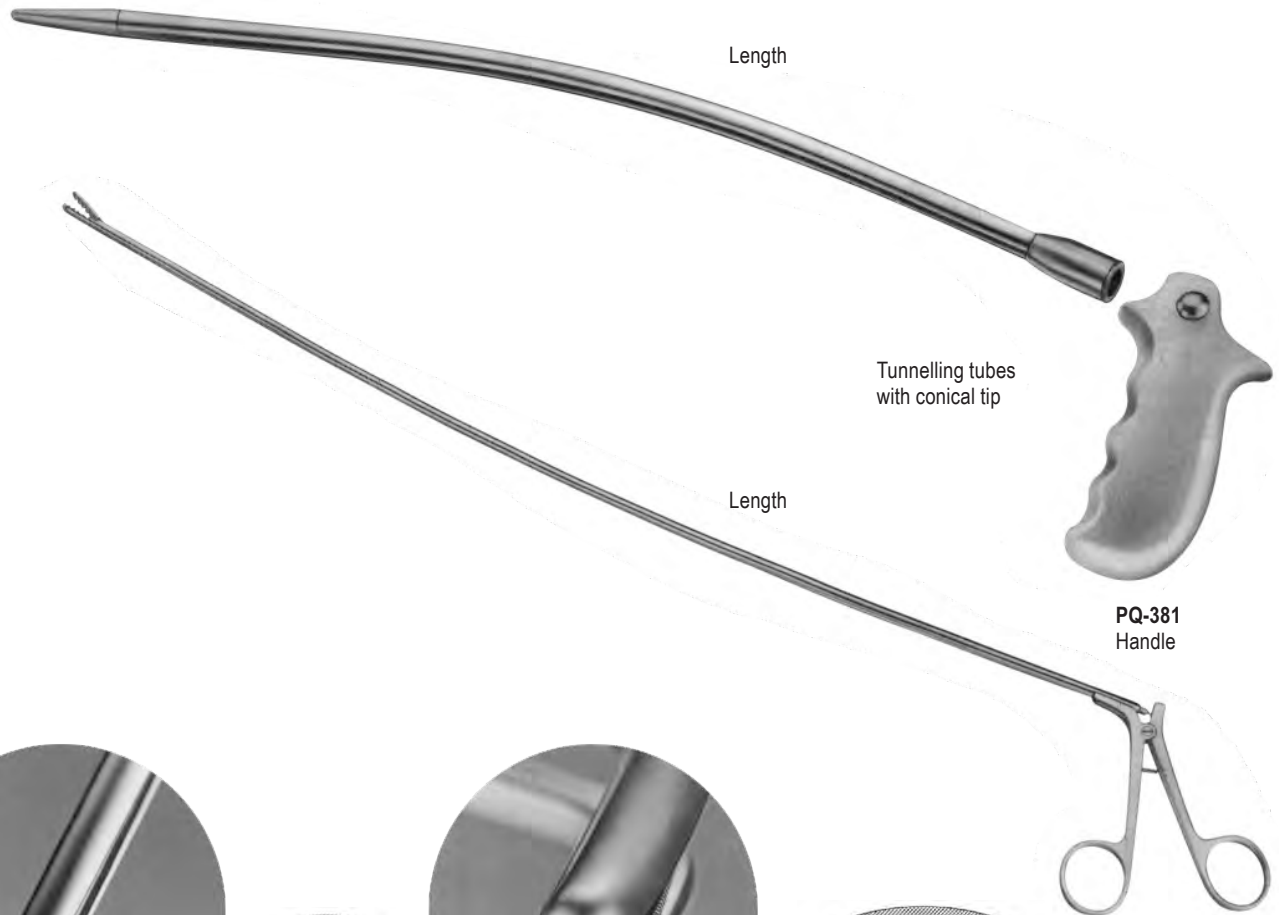

DE BAKEY
PQ-382
1 : 2 rows of teeth

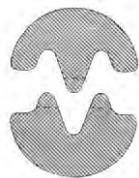

DE BAKEY
PQ-383
2 : 3 rows of teeth

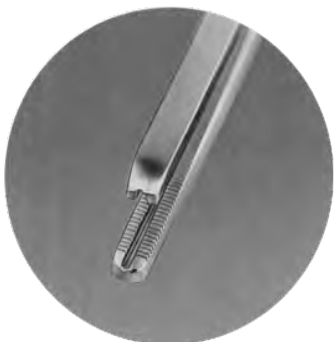
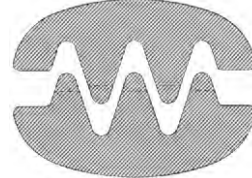

COOLEY
PQ-384
2 : 2 rows of teeth

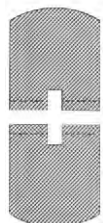

DARDIK
PQ-385
2 : 3 rows of teeth





AORTIC DILATORS

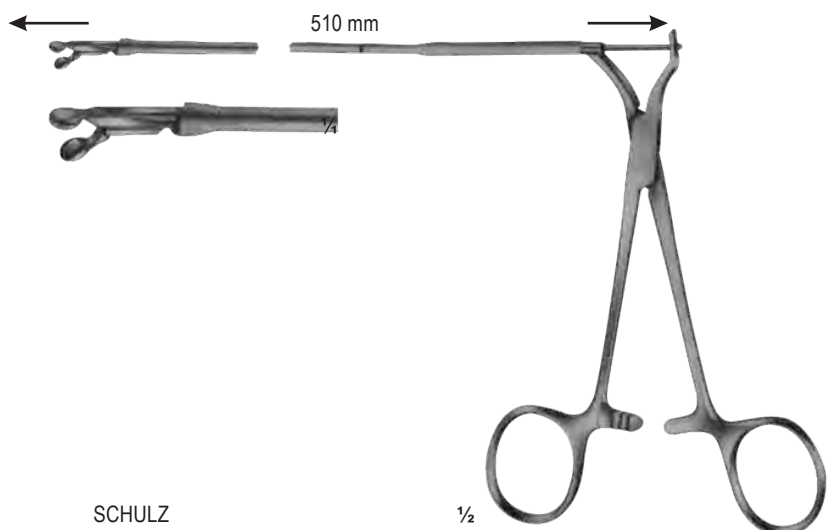

SCHULZ
PQ-386
Bioptome, mit flexiblem Schaft, 510 mm lang,
with round jaws 3 mm diam.

Biopsy forceps, for biopsy from the right atrium
through cava juglaris, prior to heart implantations.

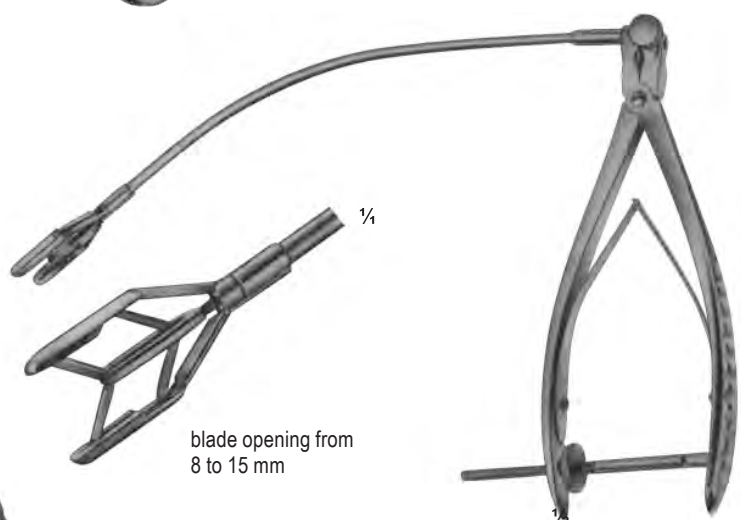

COOLEY
PQ-387
Dilator for
mitral valve
for children

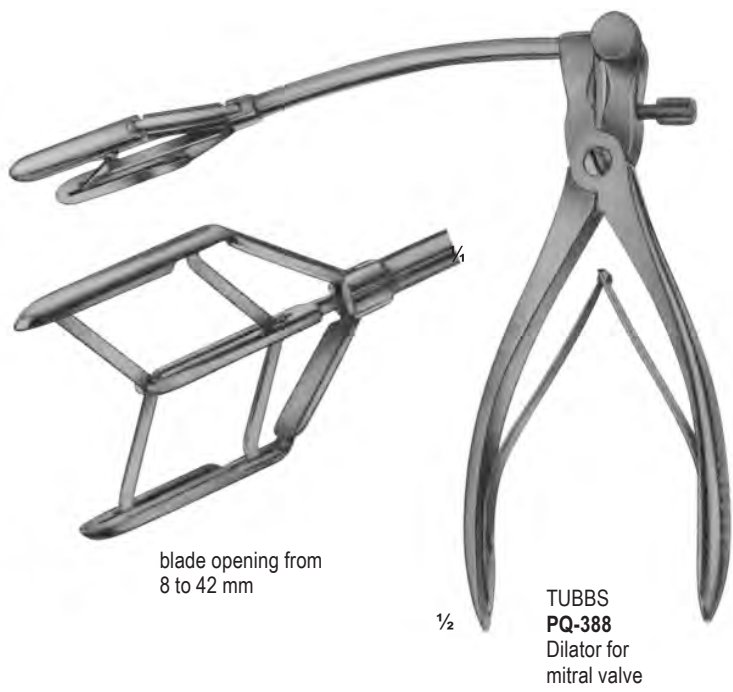

TUBBS
PQ-388
Dilator for
mitral valve

blade opening from
8 to 42 mm

blade opening from
8 to 15 mm





RIB HOLDING FORCEPS

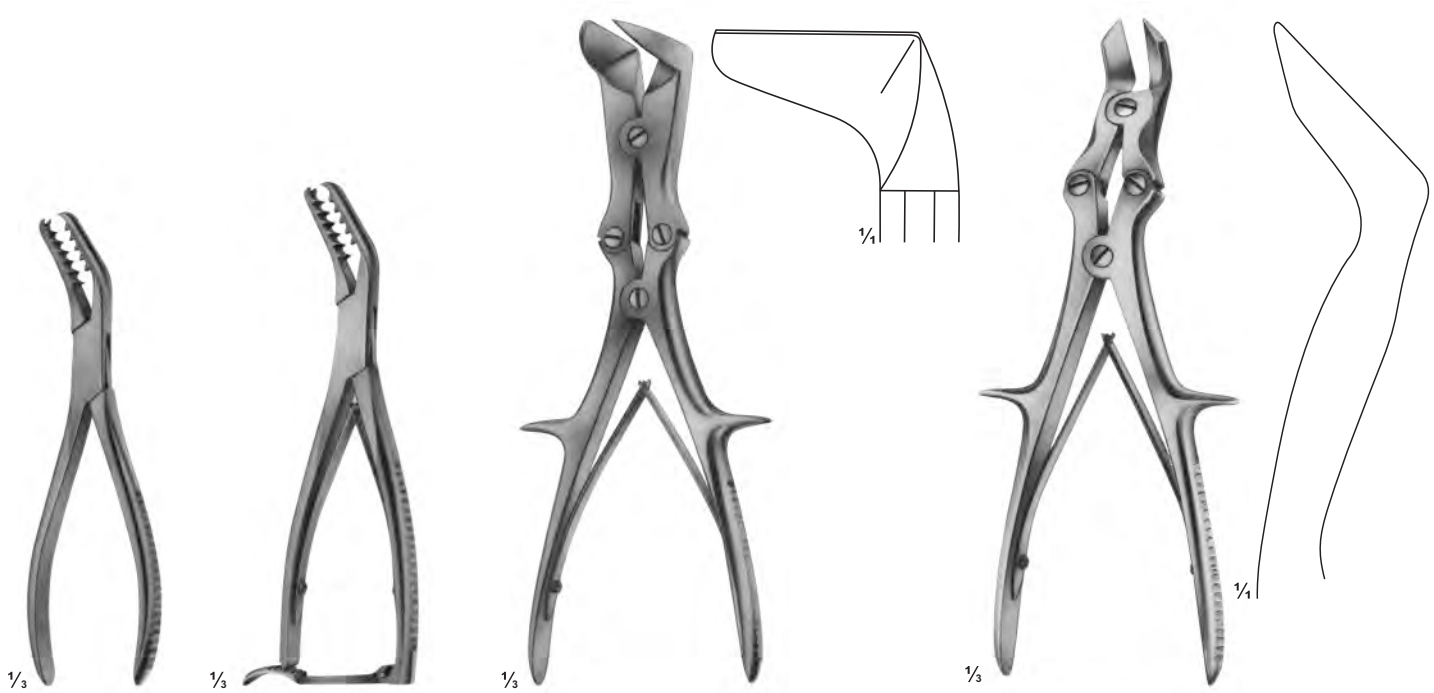

PQ-393
SEMB
Rib-and Bone
Holding forceps
190 mm

PQ-394
SEMB
Rib-and Bone
Holding forceps
190 mm

PQ-395
LISTON-STILLE
265 mm

PQ-396
LISTON-KEY-HORSLEY
255 mm

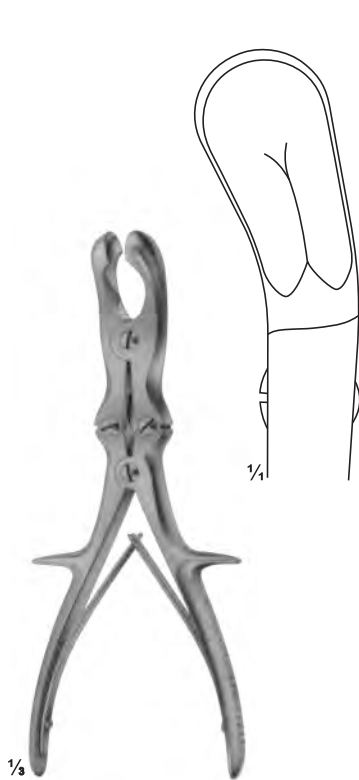

PQ-397
SEME
Rib Rongeur to shorten
the rib stumps
240 mm

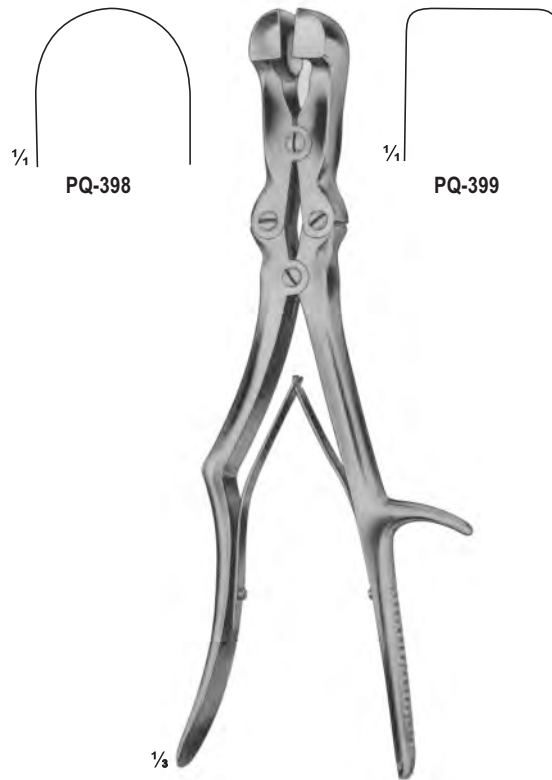

PQ-398 - PQ-399
SAUERDRUCH-CORYLLOS
Rib rongeurs to shorten
the rib stumps
310 mm

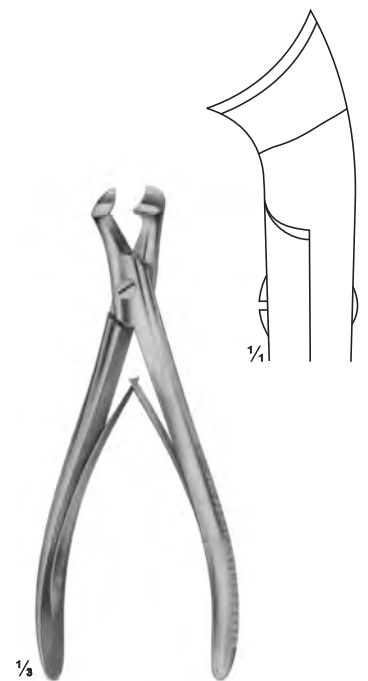

PQ-400
MARKWALDER
Rib Rongeur to Round
the rib stumps
190 mm



RIB RASPATORIES

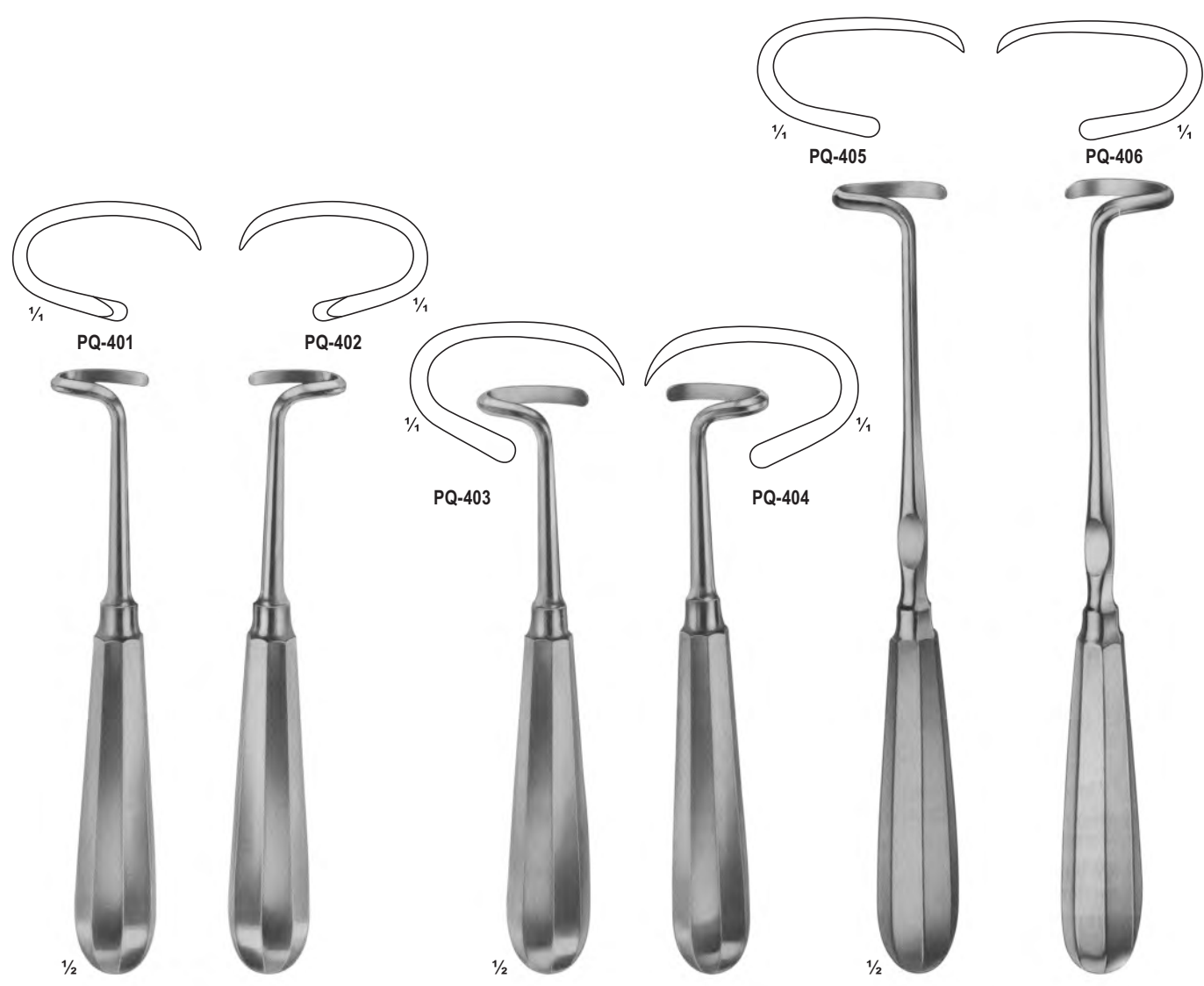

PQ-401 - PQ-402
DOYEN
for children
175 mm

PQ-403 - PQ-404
DOYEN
for adults
175 mm

PQ-405 - PQ-406
DOYEN
240 mm



$\frac{1}{2}$
PQ-407 - PQ-411
SEMB
230 mm

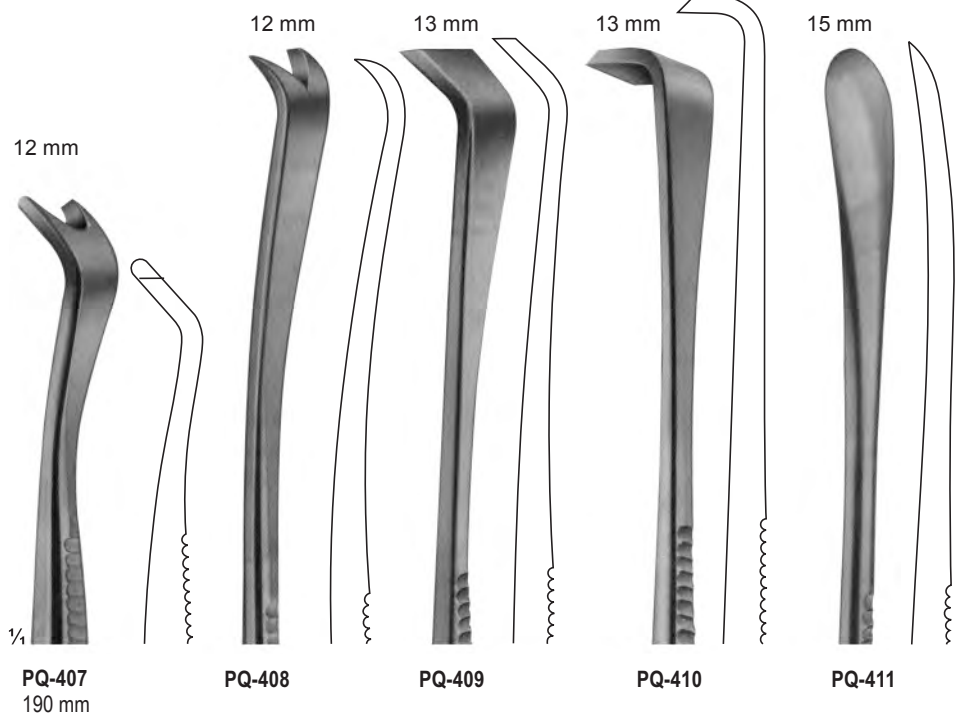

$\frac{1}{2}$
PQ-412
LANGENBECK
190 mm

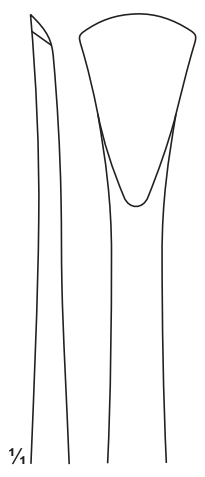

$\frac{1}{2}$
PQ-413 - PQ-417
LAMBOTTE
215 mm

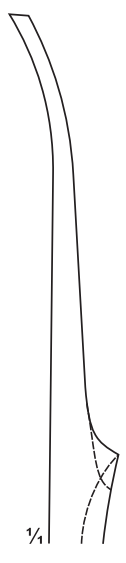

PQ-413 5 mm
PQ-414 10 mm
PQ-415 15 mm
PQ-416 20 mm
PQ-417 25 mm



$\frac{1}{2}$
PQ-418
ALEXANDER
210 mm

