

# Page 01-26

- Dilators
- Biopsy Instruments And Curettes
- Uterine Probes, Uterine Dressing -Tenaculum
- Ovum Forceps
- Uterine Elevating Forceps



1/2

**NO-001 - NO-043**  
HEGAR  
with very conical point  
185 mm

|               |       |               |          |
|---------------|-------|---------------|----------|
| <b>NO-001</b> | 1 mm  | <b>NO-023</b> | 23 mm    |
| <b>NO-002</b> | 2 mm  | <b>NO-024</b> | 24 mm    |
| <b>NO-003</b> | 3 mm  | <b>NO-025</b> | 25 mm    |
| <b>NO-004</b> | 4 mm  | <b>NO-026</b> | 26 mm    |
| <b>NO-005</b> | 5 mm  | <b>NO-027</b> | 1 1/2mm  |
| <b>NO-006</b> | 6 mm  | <b>NO-028</b> | 2 1/2mm  |
| <b>NO-007</b> | 7 mm  | <b>NO-029</b> | 3 1/2mm  |
| <b>NO-008</b> | 8 mm  | <b>NO-030</b> | 4 1/2mm  |
| <b>NO-009</b> | 9 mm  | <b>NO-031</b> | 5 1/2mm  |
| <b>NO-010</b> | 10 mm | <b>NO-032</b> | 6 1/2mm  |
| <b>NO-011</b> | 11 mm | <b>NO-033</b> | 7 1/2mm  |
| <b>NO-012</b> | 12 mm | <b>NO-034</b> | 8 1/2mm  |
| <b>NO-013</b> | 13 mm | <b>NO-035</b> | 9 1/2mm  |
| <b>NO-014</b> | 14 mm | <b>NO-036</b> | 10 1/2mm |
| <b>NO-015</b> | 15 mm | <b>NO-037</b> | 11 1/2mm |
| <b>NO-016</b> | 16 mm | <b>NO-038</b> | 12 1/2mm |
| <b>NO-017</b> | 17 mm | <b>NO-039</b> | 13 1/2mm |
| <b>NO-018</b> | 18 mm | <b>NO-040</b> | 14 1/2mm |
| <b>NO-019</b> | 19 mm | <b>NO-041</b> | 15 1/2mm |
| <b>NO-020</b> | 20 mm | <b>NO-042</b> | 16 1/2mm |
| <b>NO-021</b> | 21 mm | <b>NO-043</b> | 17 1/2mm |
| <b>NO-022</b> | 22 mm |               |          |



1/2

**NO-044 - NO-052**  
HEGAR  
205 mm

|               |          |
|---------------|----------|
| <b>NO-044</b> | 1+2 mm   |
| <b>NO-045</b> | 3+4 mm   |
| <b>NO-046</b> | 5+6 mm   |
| <b>NO-047</b> | 7+8 mm   |
| <b>NO-048</b> | 9+10 mm  |
| <b>NO-049</b> | 11+12 mm |
| <b>NO-050</b> | 13+14 mm |
| <b>NO-051</b> | 15+16 mm |
| <b>NO-052</b> | 17+18 mm |



1/4

**NO-053**  
HEGAR  
Uterine dilator set, in canvas  
roll with 8 dilators.



UTERINE DILATORS – COMPLETE SETS



**NO-054**  
HEGAR  
Dilator set consisting of:  
14 Dilators,  
1 Rack for dilators ( 4 - 12 mm )  
1 Rack for Dilators ( 13 - 17 mm )  
1 Metal case only,  
with hinged lid, stainless 200 X 100 X 35 mm

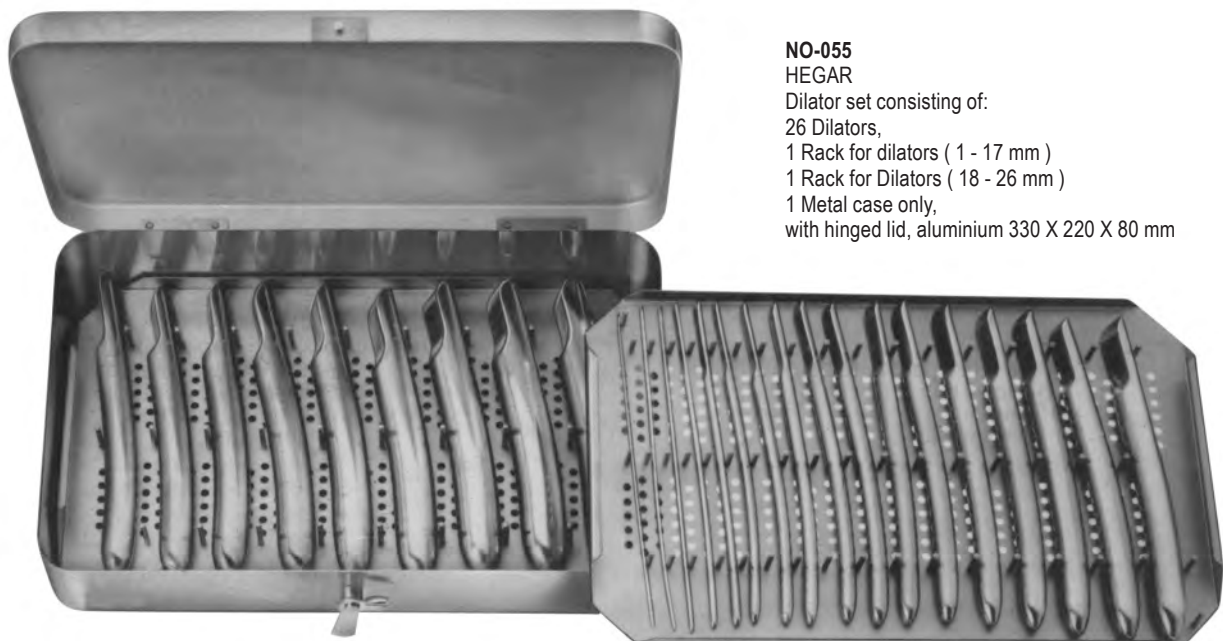

**NO-055**  
HEGAR  
Dilator set consisting of:  
26 Dilators,  
1 Rack for dilators ( 1 - 17 mm )  
1 Rack for Dilators ( 18 - 26 mm )  
1 Metal case only,  
with hinged lid, aluminium 330 X 220 X 80 mm

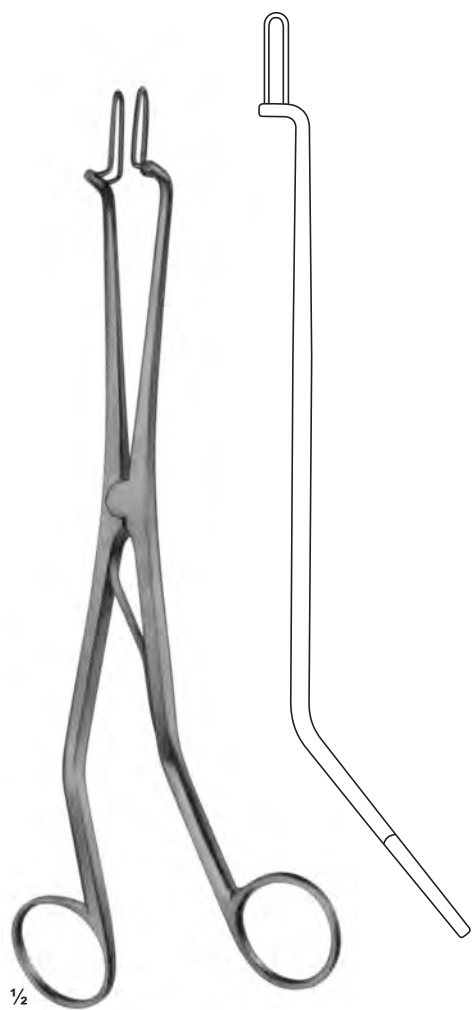

**NO-056**  
KOGAN  
Endospecula for cervix  
and urethra, without ratchet  
240 mm



**NO-057**  
KOGAN  
Endospecula for cervix  
and urethra, with  
scale-ratchet and fixing screws  
240 mm



UTERINE PROBES, COTTON AND CAUSTIC HOLDER

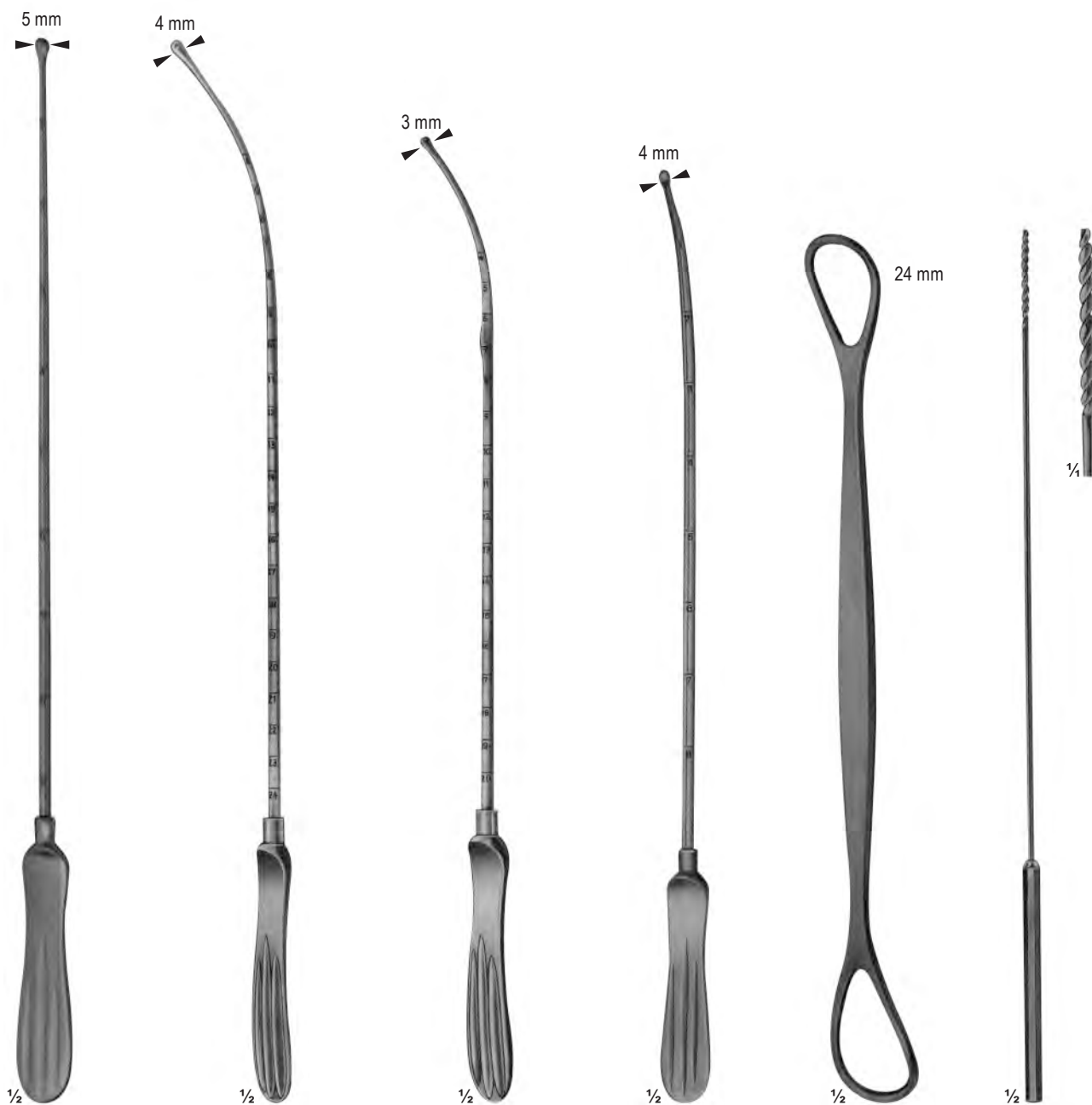

**NO-058**  
MAYO  
biegsam malleable  
330 mm

**NO-059**  
SIMS  
biegsam malleable  
330 mm

**NO-060**  
MARTIN  
330 mm

**NO-061**  
SIMPSON  
malleable  
silver-plated  
290 mm

**NO-062**  
BRAUN  
Uterine  
depressor  
270 mm

**NO-063**  
Cotton  
applicator  
270 mm

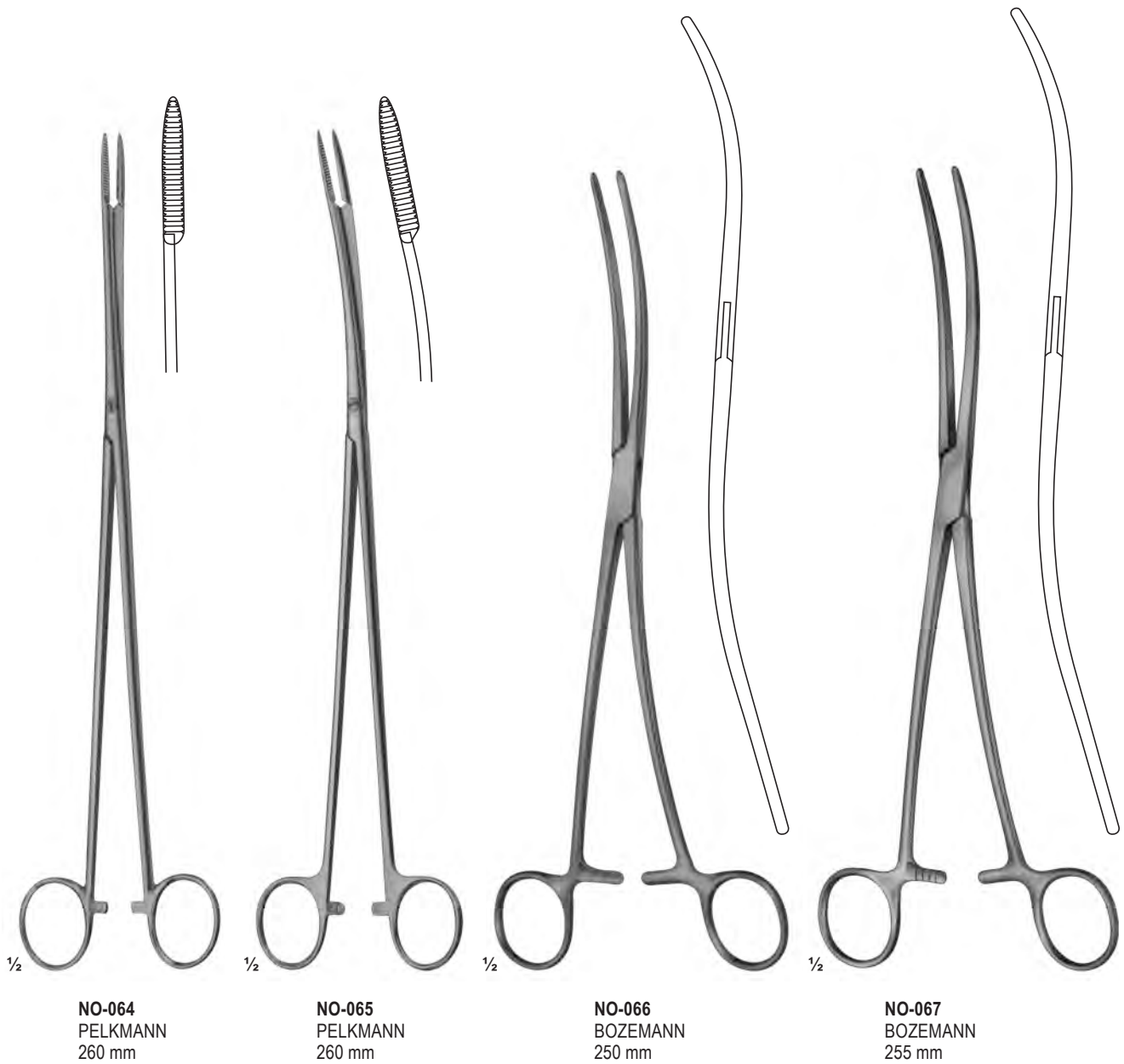

Jaws with longitudinal groove



UTERINE DRESSING FORCEPS

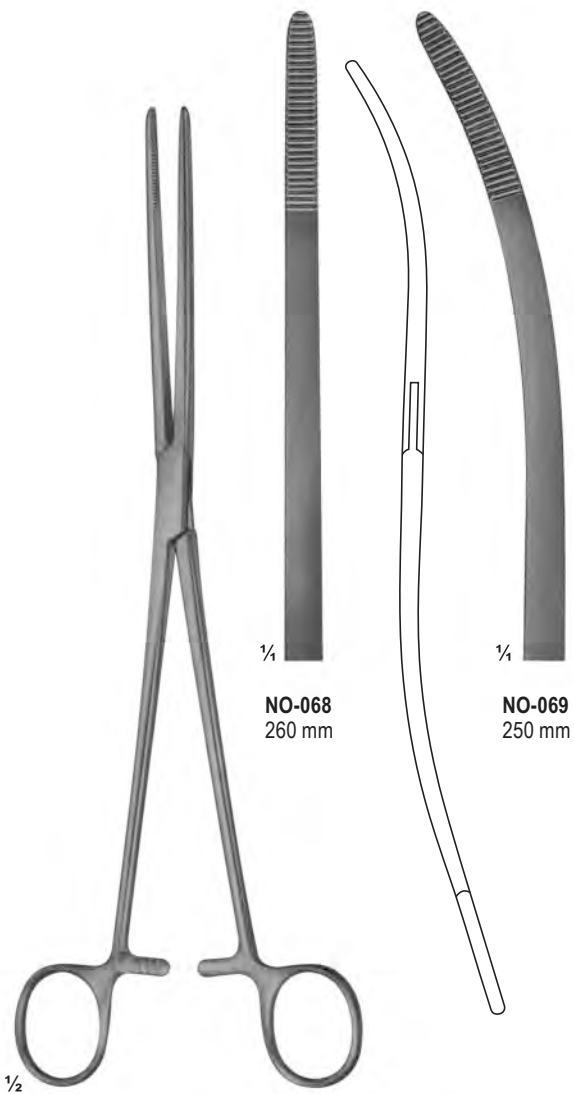

**NO-068**  
260 mm

**NO-069**  
250 mm

**NO-068 - NO-069**  
BOZEMANN



**NO-070**  
BOZEMANN-DOUGLAS  
260 mm



**NO-071**  
BRAUN  
slender type  
250 mm



**NO-072**  
SCHRODER  
250 mm



**NO-073**  
POZZI  
heavy type  
255 mm





UTERINE TENACULUM FORCEPS



**NO-074**  
265 mm

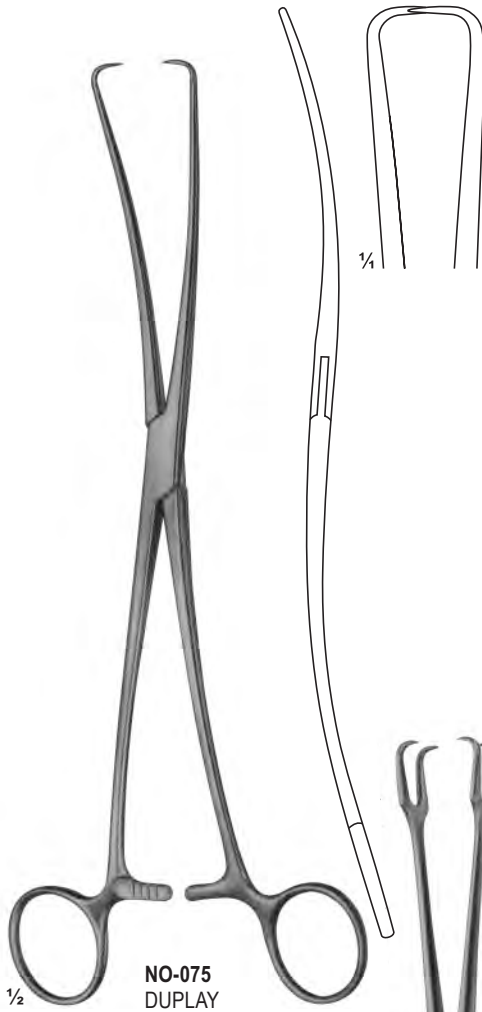

**NO-075**  
DUPLAY  
250 mm

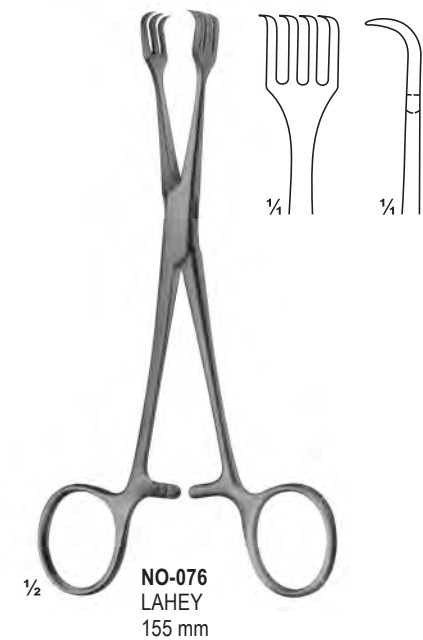
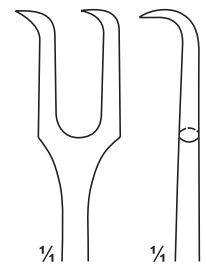

**NO-076**  
LAHEY  
155 mm

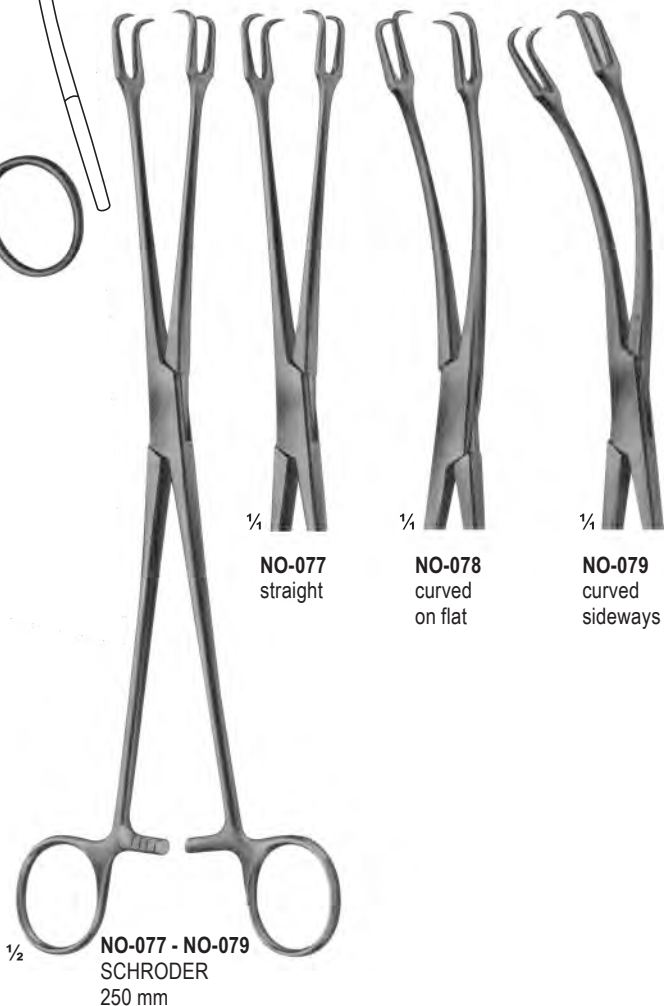

**NO-077**  
straight

**NO-078**  
curved  
on flat

**NO-079**  
curved  
sideways

**NO-077 - NO-079**  
SCHRODER  
250 mm

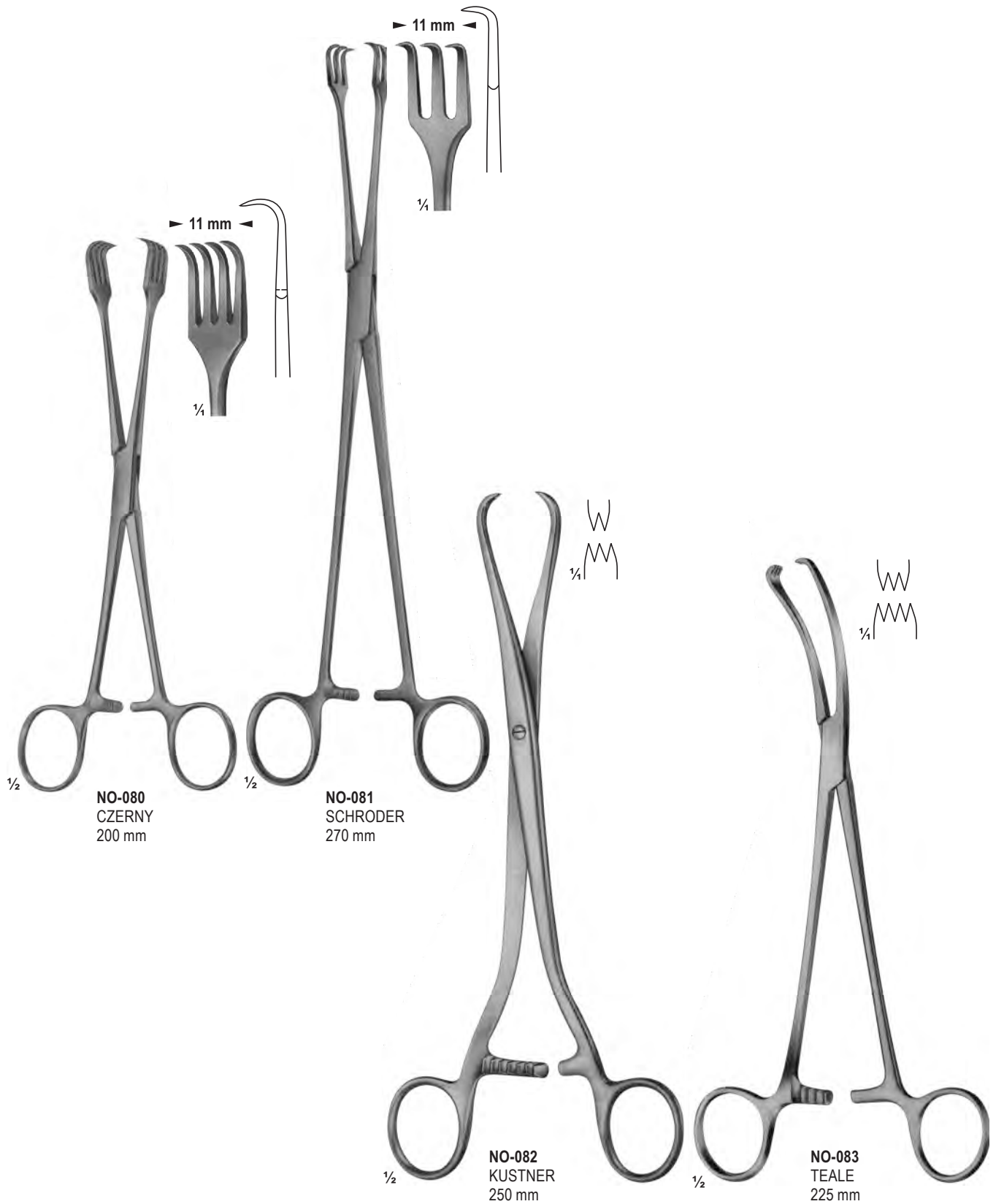



UTERINE ELEVATING FORCEPS

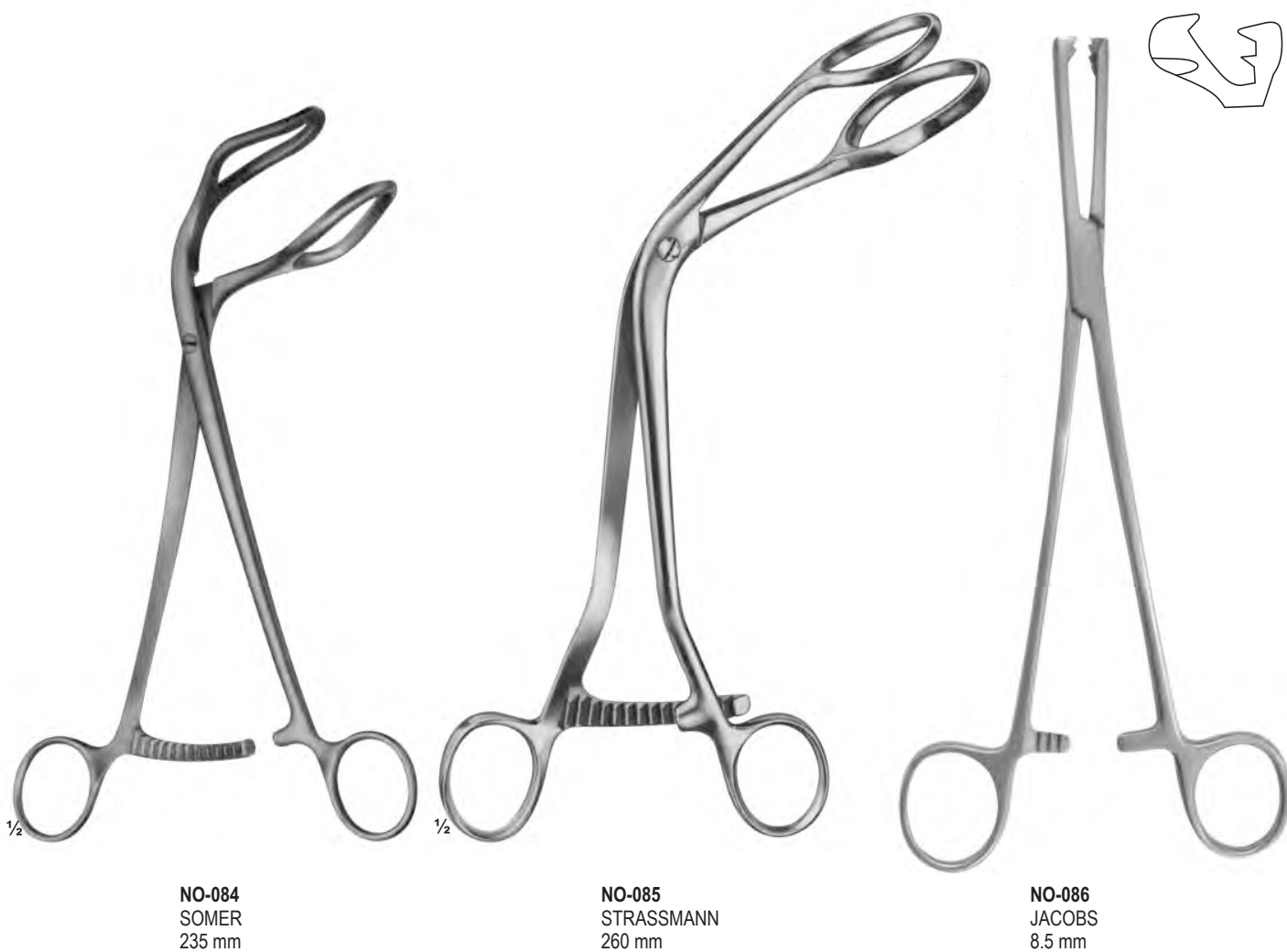

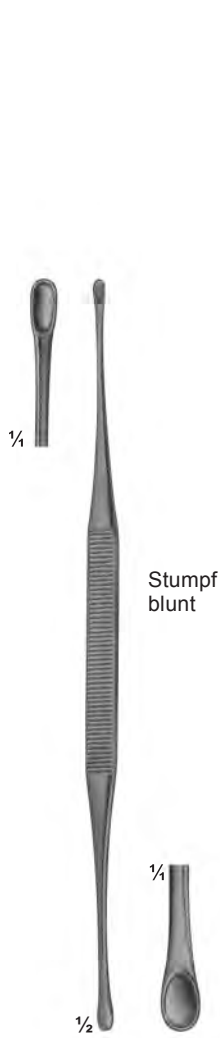

**NO-087**  
ASCH  
Uterine  
Secretion scoop  
200 mm

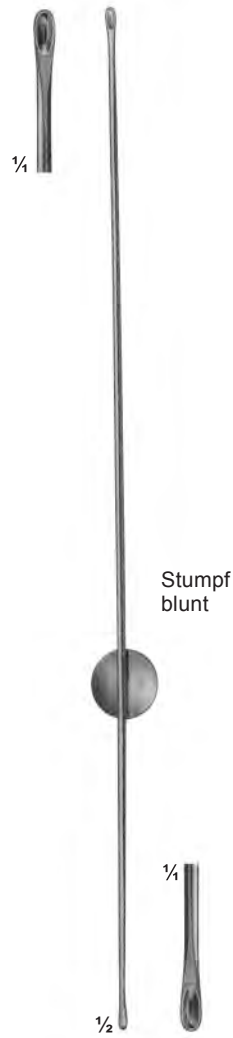

**NO-088**  
Uterine  
Secretion scoop  
270 mm



**NO-089**  
NOVAK-SCHOECKAERT  
Endometrial biopsy  
curette  
240 mm



**NO-090**  
RANDALL  
Endometrial biopsy  
curette  
240 mm



BIOPSY FORCEPS

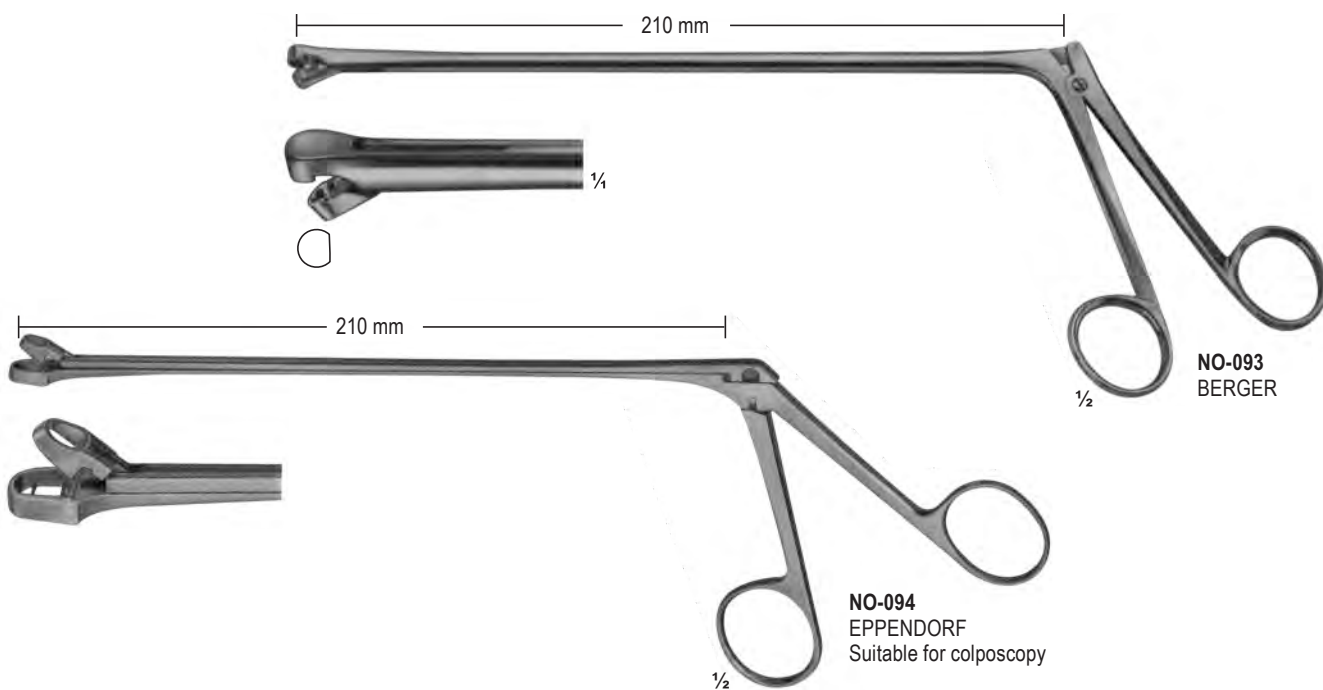

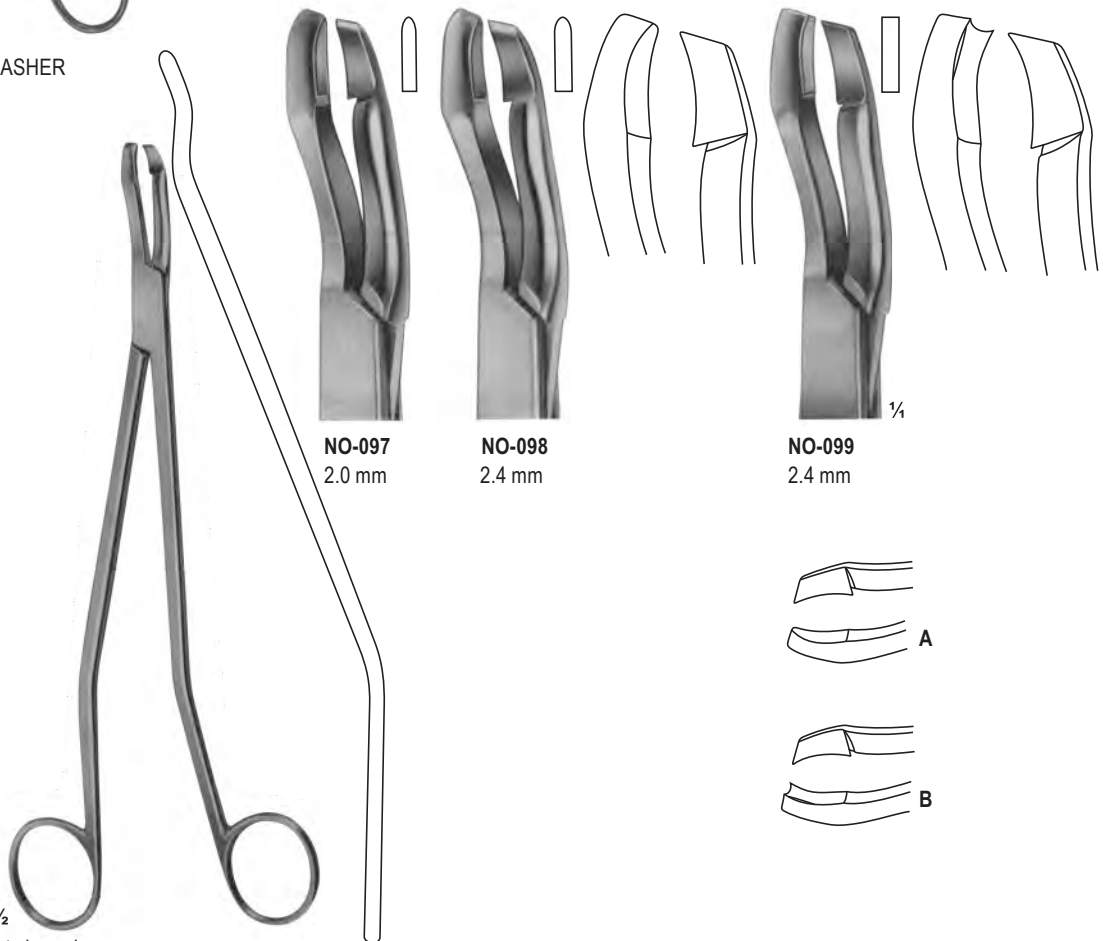
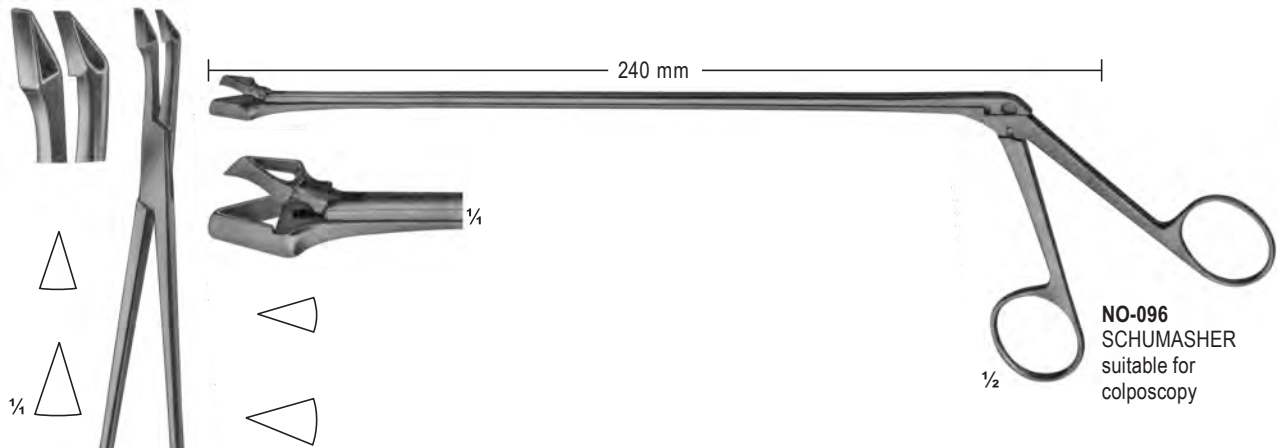

**NO-097 - 099**  
SEIDL DBP  
Biopsy forceps, bayonet shaped  
for portio, vagina and vulva  
240 mm



BIOPSY FORCEPS

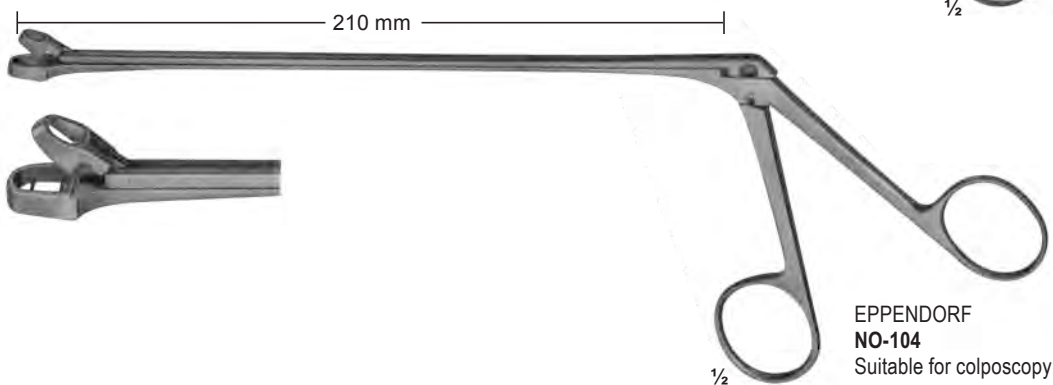
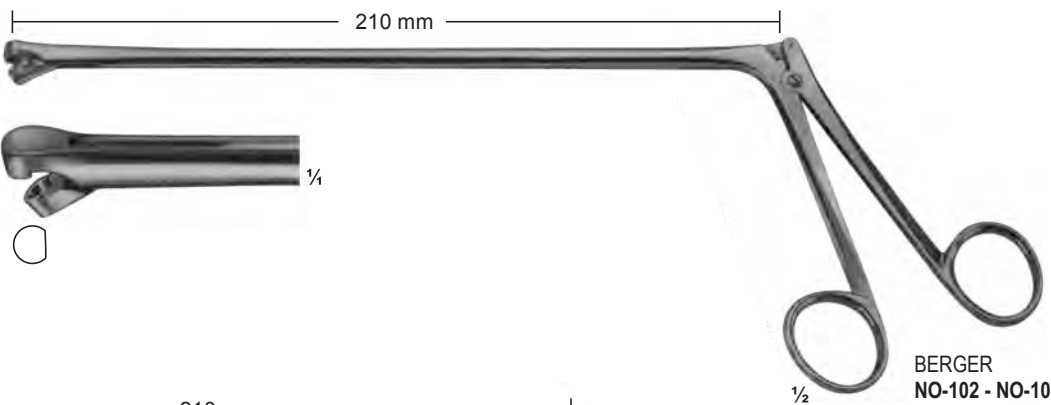
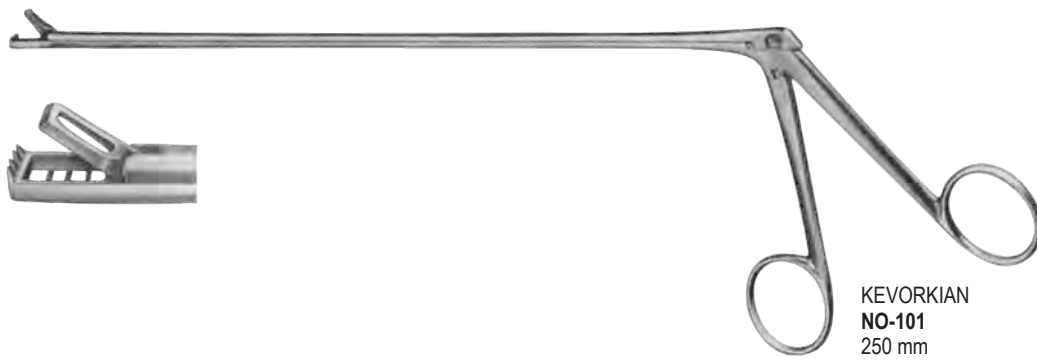
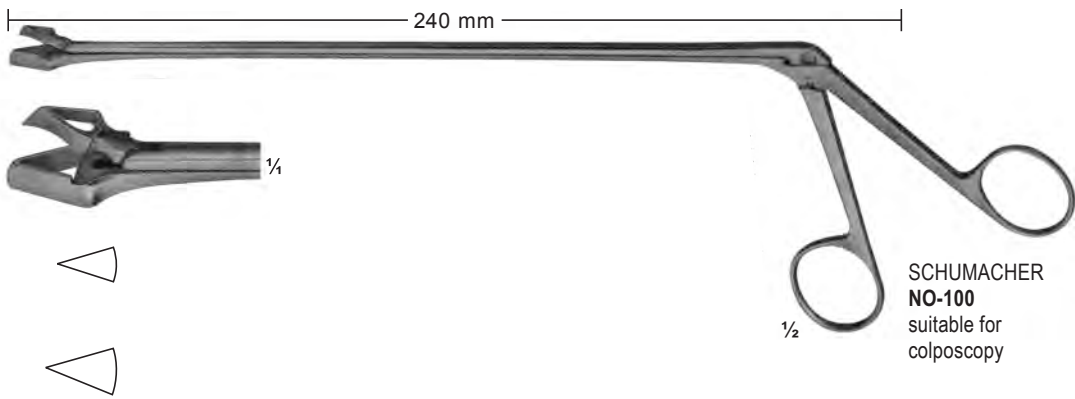



WINTER  
**NO-105 - NO-106**  
**NO-105** 230 mm  
 straight  
**NO-106** 230 mm  
 curved

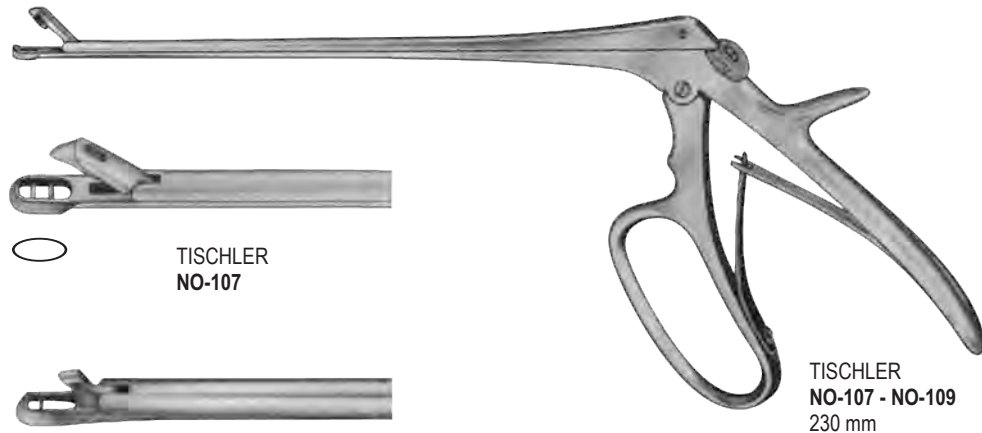

TISCHLER  
**NO-107 - NO-109**  
 230 mm



TISCHLER  
**NO-107**



TISCHLER-MINI  
**NO-108**



KEVORKIAN-PACIFIC  
**NO-109**

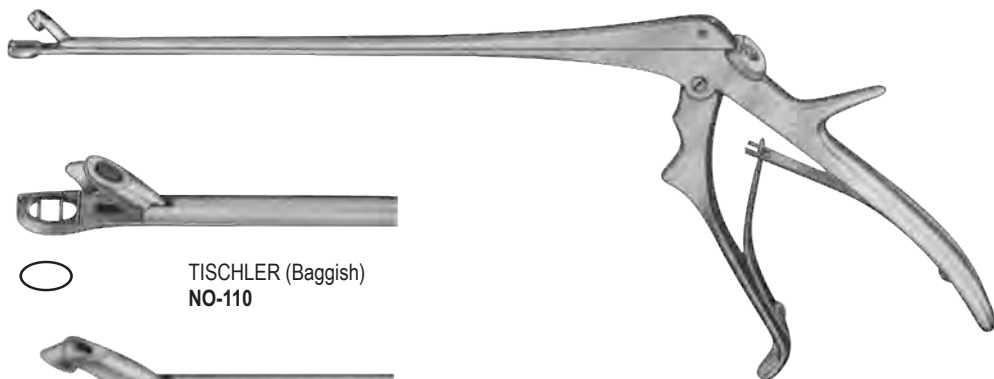

TISCHLER (Baggish)  
**NO-110**

TISCHLER-BURKE  
**NO-111**

TISCHLER  
**NO-110 - NO-111**  
 230 mm





BIOPSY FORCEPS

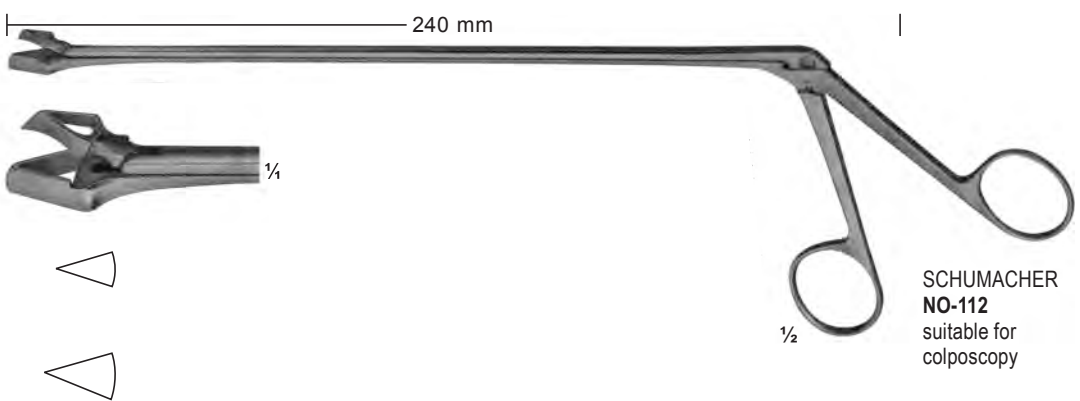

**SCHUMACHER  
NO-112**  
suitable for  
colposcopy

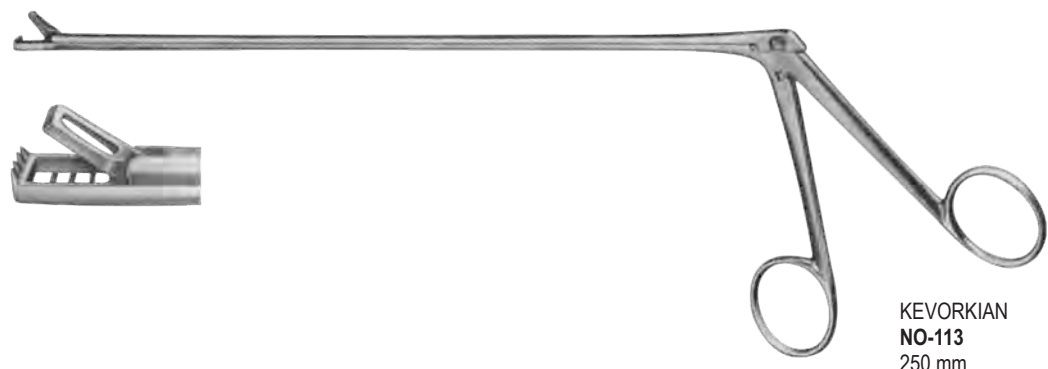

**KEVORKIAN  
NO-113**  
250 mm

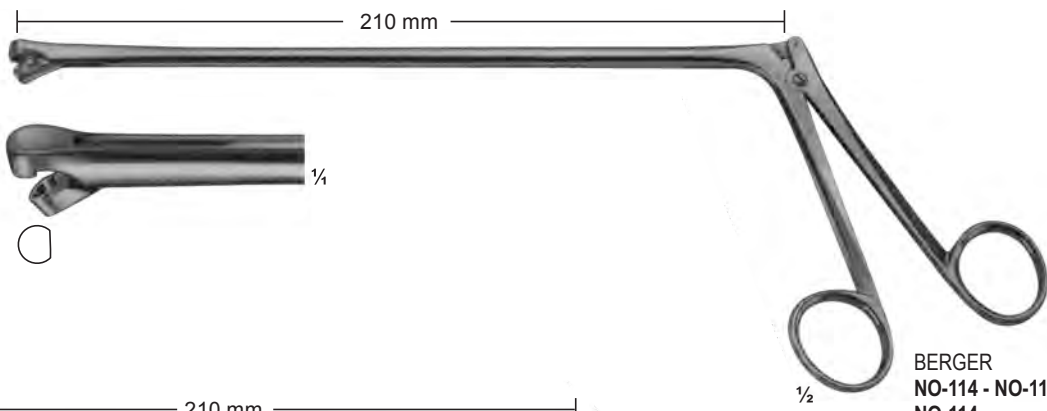

**BERGER  
NO-114 - NO-115**  
**NO-114**  
19 cm / 3 mm  
**NO-115**  
19 cm / 5 mm

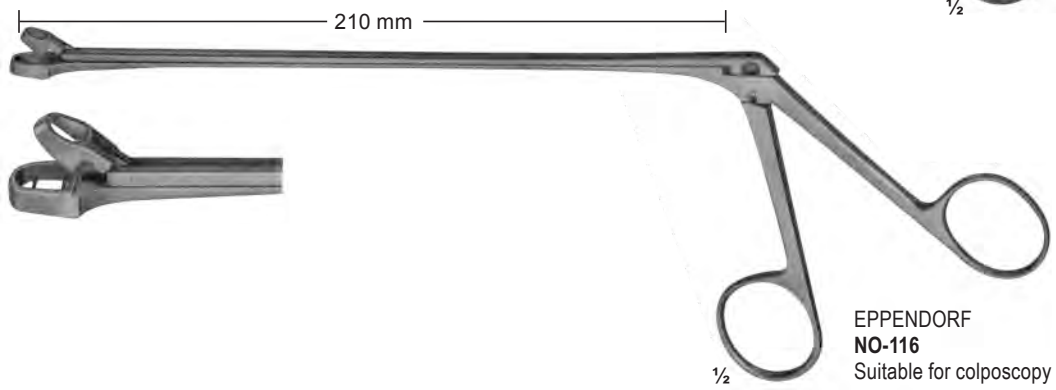

**EPPENDORF  
NO-116**  
Suitable for colposcopy

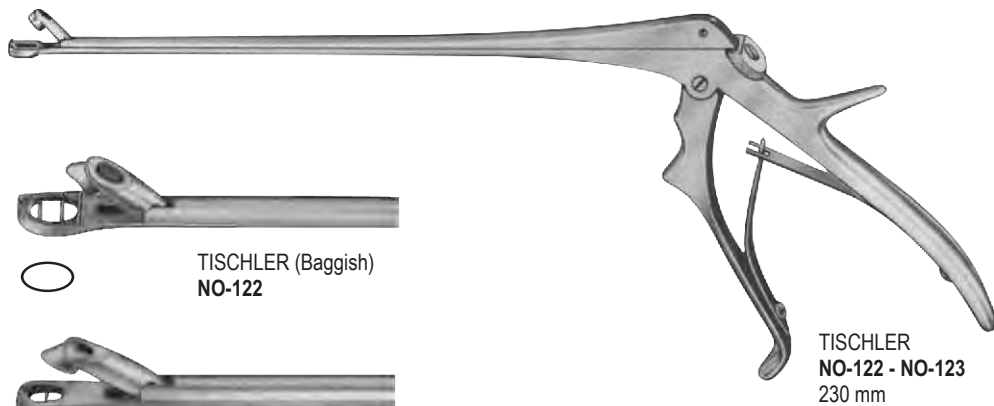
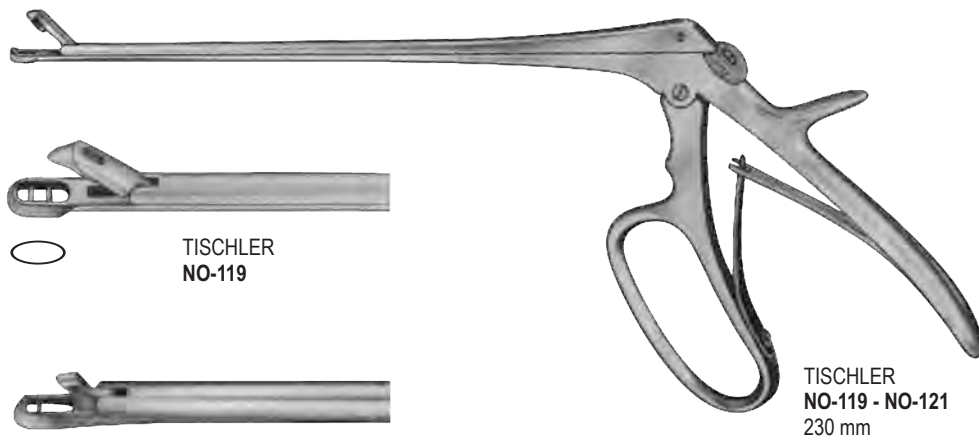



BIOPSY FORCEPS

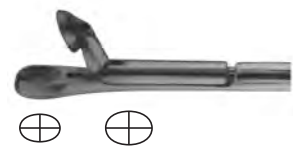
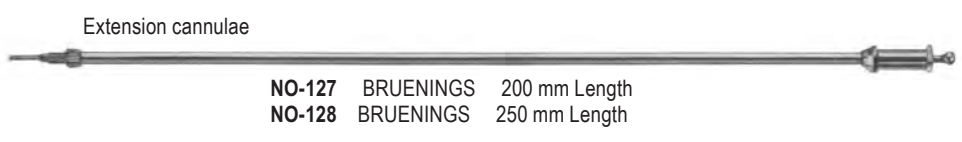
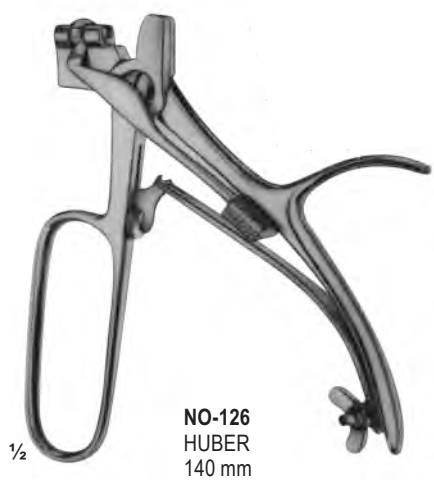
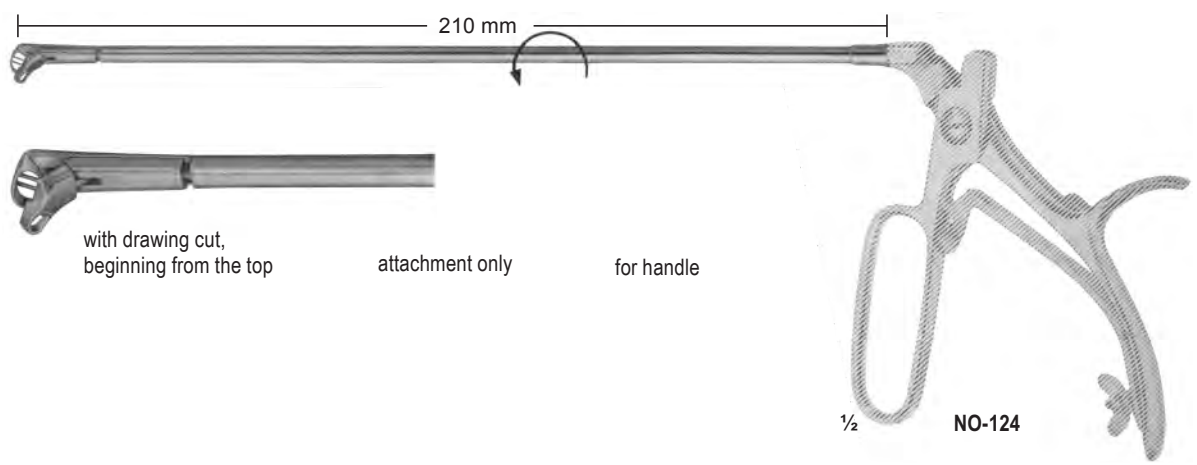

NO-129 KRAUSE ( Biopsy tip )



NO-130 SCHEINMANN ( Biopsy tip )



NO-131 SCHEINMANN ( Biopsy tip )  
with drawing cut

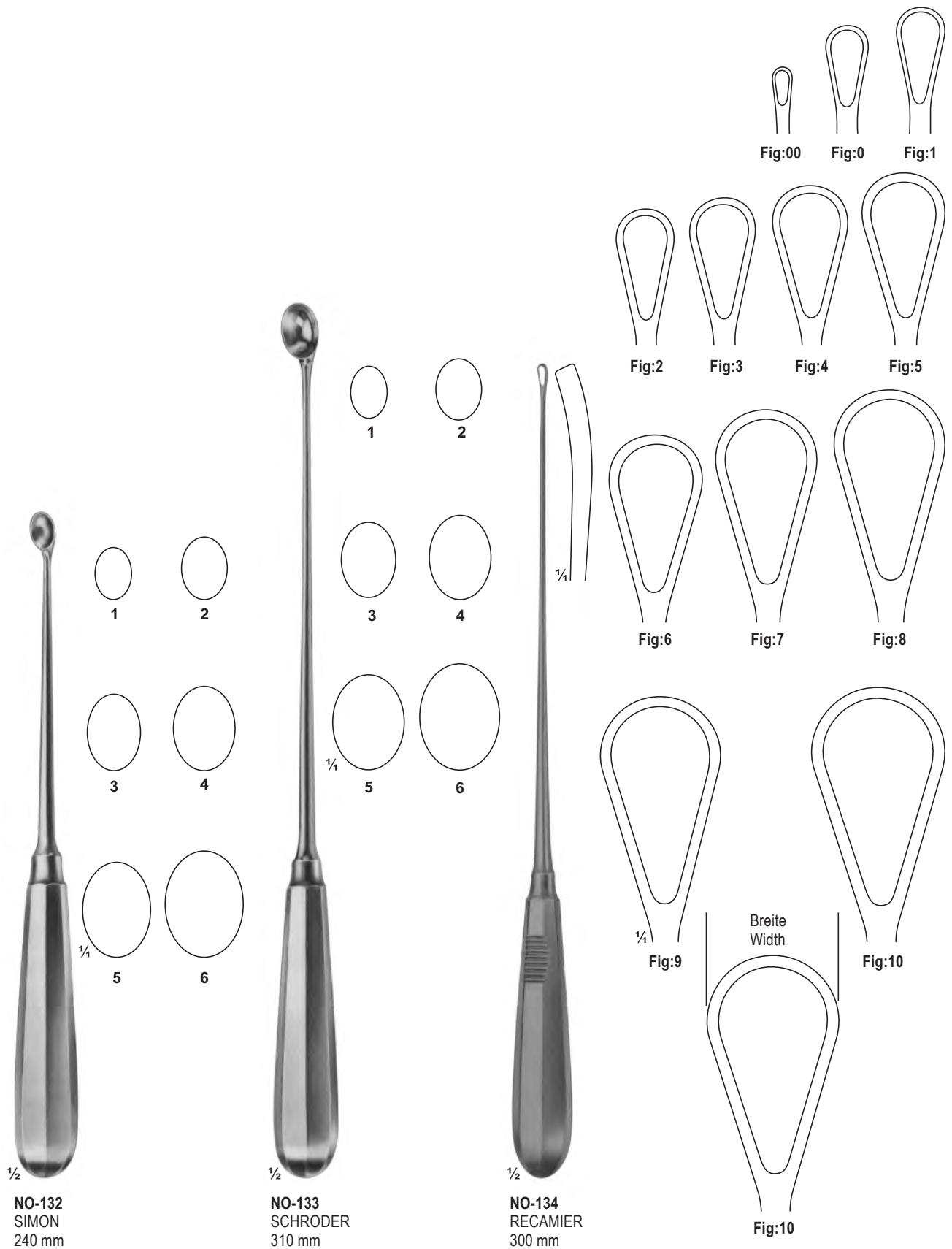





**NO-138**  
COLLIN  
300 mm



**NO-139**  
RECAMIER  
blunt-rigid  
360 mm

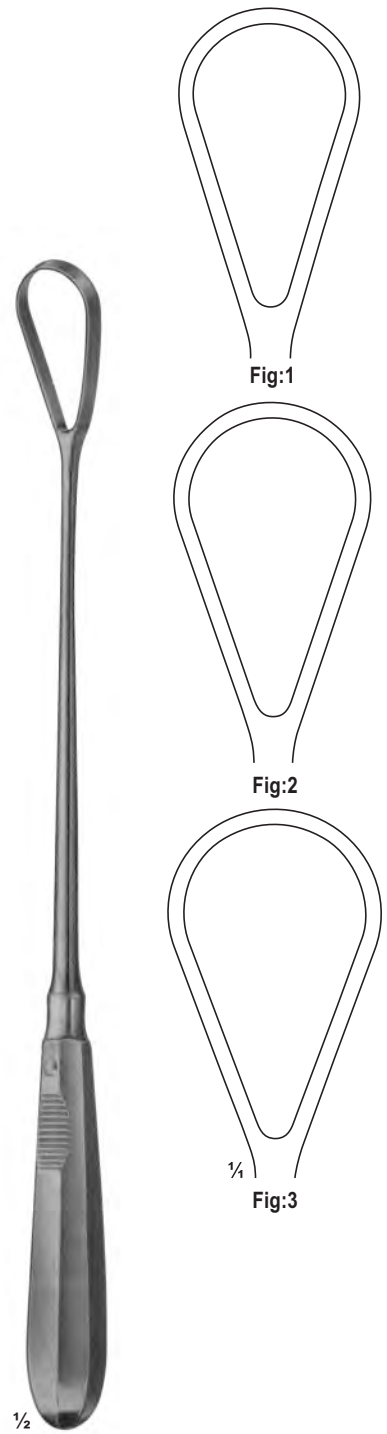
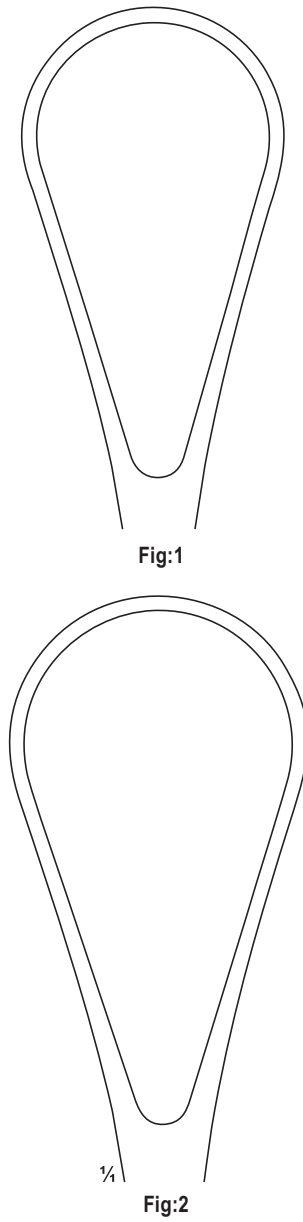

**NO-140**  
BUMM  
310 mm



CERVICAL BIOPSY AND SPECIMEN FORCEPS

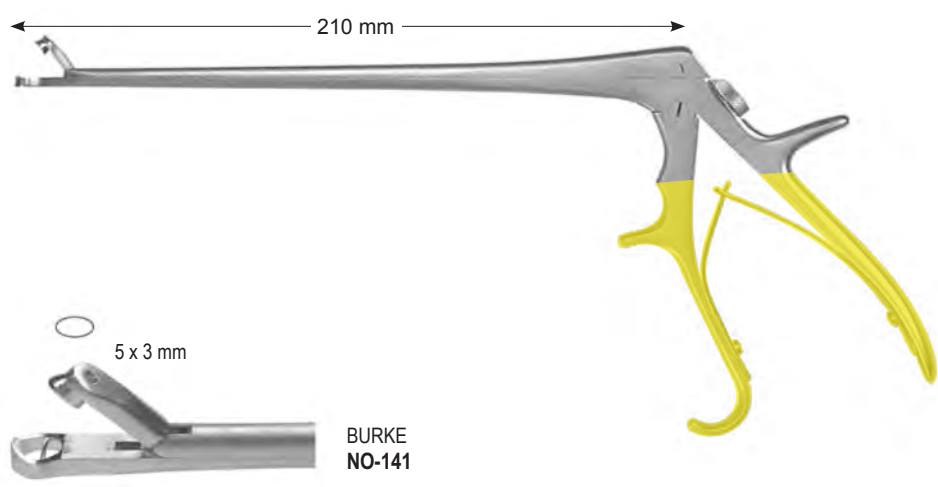

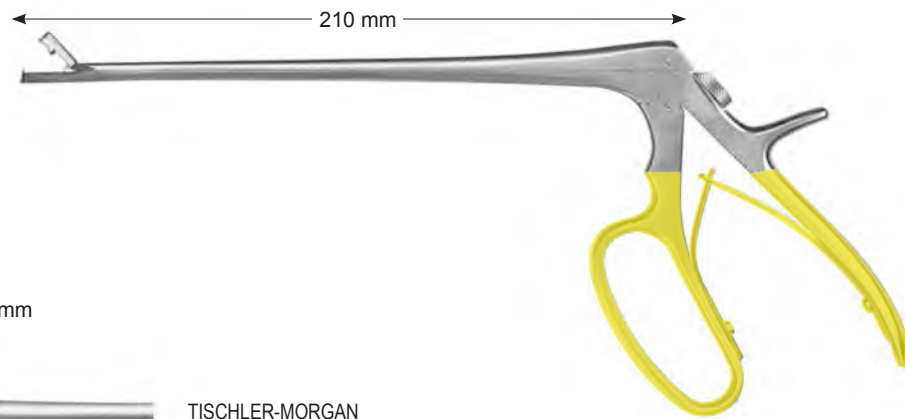

7 x 3 mm



TISCHLER-MORGAN  
NO-142

2.3 x 4 mm



MINI-TOWNSEND  
NO-143

9 x 3 mm



TISCHLER-KEVORKIAN  
NO-145

2.3 x 4 mm



BABY-TISCHLER  
NO-144

9 x 3 mm



KEVORKIAN-PACIFIC  
NO-146





UTERINE DILATORS



1/2

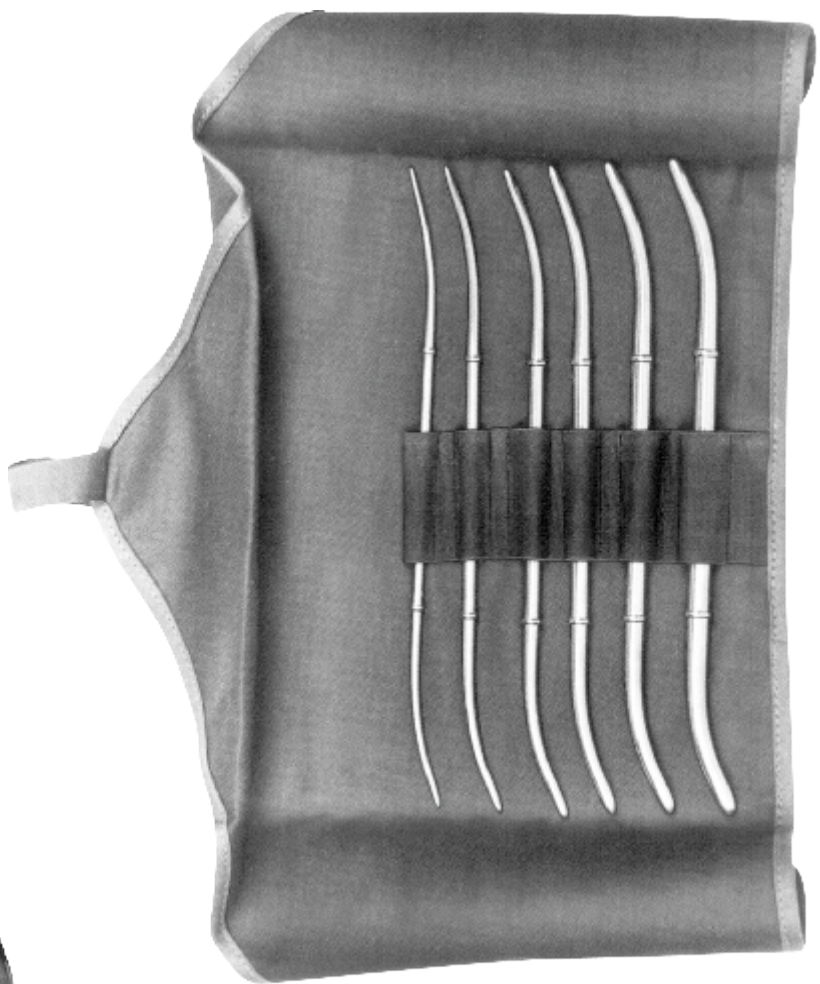

Hank  
**NO-147 - 152**  
26.5 cm  
American scale

Hank  
**NO-153**  
Set of 6 piezas in boilable canvas roll

Fig. mm

|               |       |          |
|---------------|-------|----------|
| <b>NO-147</b> | 9/10  | 4.5/5.0  |
| <b>NO-148</b> | 11/12 | 5.5/6.0  |
| <b>NO-149</b> | 13/14 | 6.5/7.0  |
| <b>NO-150</b> | 15/16 | 7.5/8.0  |
| <b>NO-151</b> | 17/18 | 8.5/9.0  |
| <b>NO-152</b> | 19/20 | 9.5/10.0 |



**NO-154**  
6 mm



**NO-157**  
9 mm



**NO-160**  
6 mm



**NO-155**  
8 mm

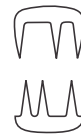

**NO-158**  
11 mm



**NO-161**  
8 mm



**NO-156**  
10 mm



**NO-159**  
13 mm



**NO-162**  
10 mm

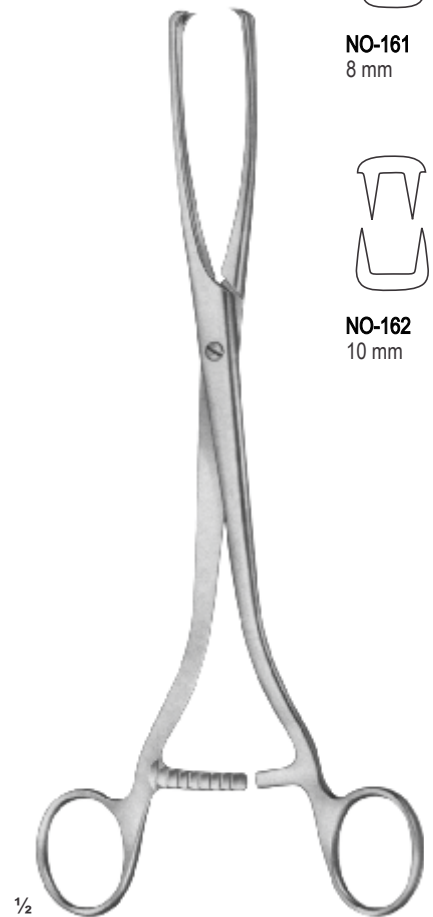
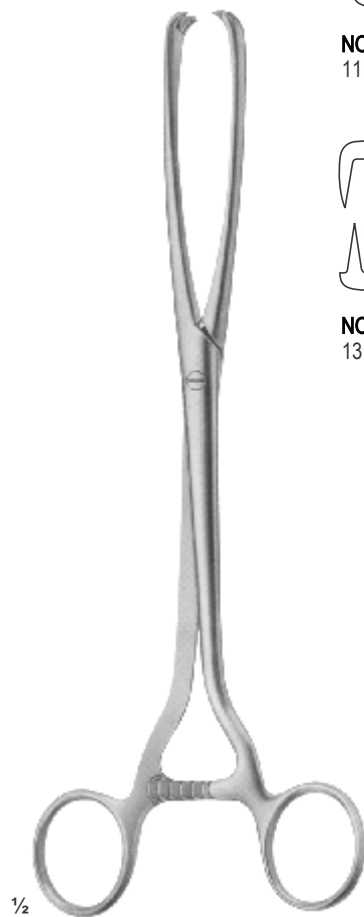
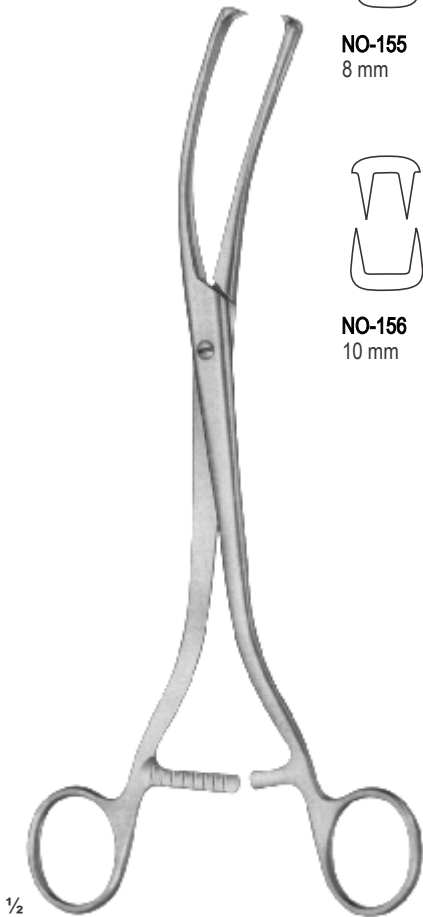

Museux  
**NO-154 - 156**  
24 cm  
Curved sideways



Museux  
**NO-157 - 159**  
24 cm  
Curved sideways



Museux  
**NO-160 - 162**  
24 cm





SUCTION CURETTES, BIOPSY CURETTES

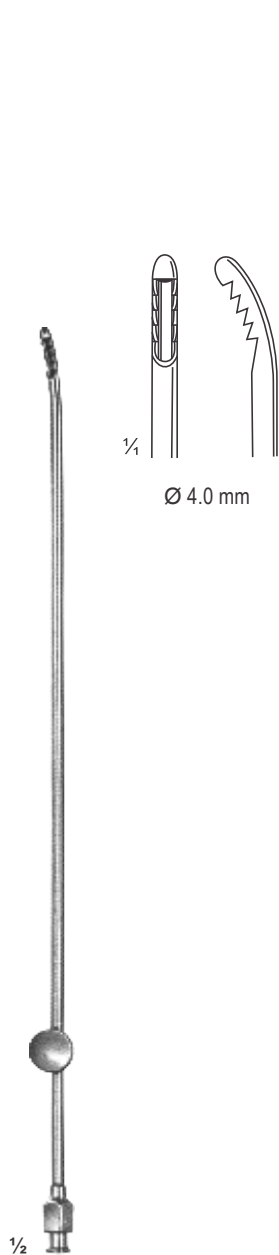

Novak  
**NO-163**  
24.5 cm  
Suctions curettes  
with Luer-Lock connection



München  
**NO-164**  
27 cm  
Uterine biopsy curette

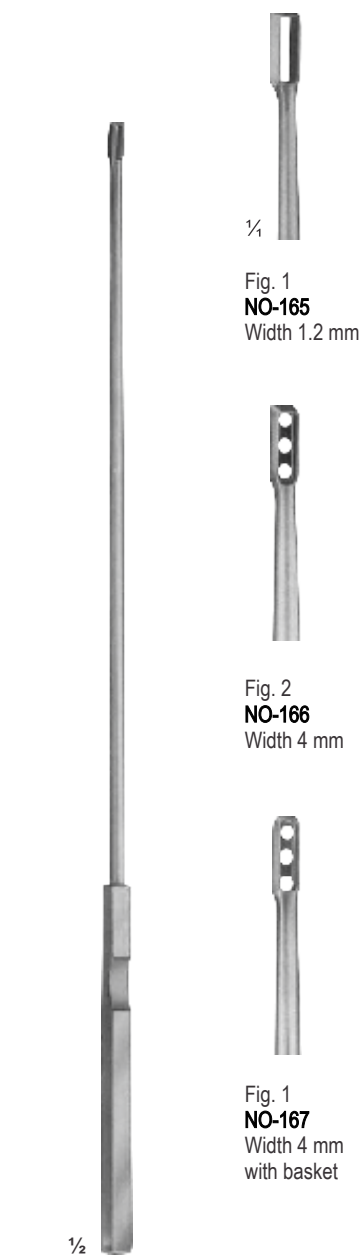

Kevorkian  
**NO-165 - 167**  
30 cm  
Uterine biopsy curatte

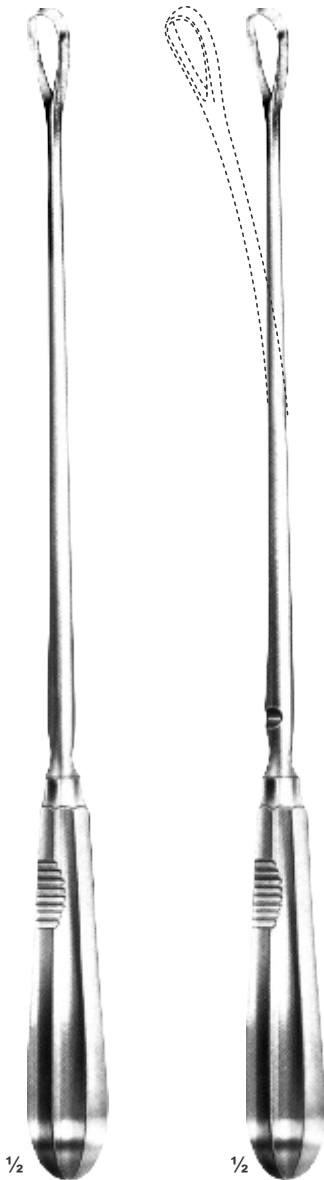

**Sharp Rigid**

|         |               |       |
|---------|---------------|-------|
| Fig. 00 | <b>NO-168</b> | 5 mm  |
| Fig. 0  | <b>NO-169</b> | 6 mm  |
| Fig. 1  | <b>NO-170</b> | 7 mm  |
| Fig. 2  | <b>NO-171</b> | 8 mm  |
| Fig. 3  | <b>NO-172</b> | 9 mm  |
| Fig. 4  | <b>NO-173</b> | 11 mm |
| Fig. 5  | <b>NO-174</b> | 12 mm |
| Fig. 6  | <b>NO-175</b> | 14 mm |
| Fig. 7  | <b>NO-176</b> | 15 mm |
| Fig. 8  | <b>NO-177</b> | 16 mm |
| Fig. 9  | <b>NO-178</b> | 19 mm |
| Fig. 10 | <b>NO-179</b> | 20 mm |
| Fig. 11 | <b>NO-180</b> | 21 mm |
| Fig. 12 | <b>NO-181</b> | 23 mm |
| Fig. 13 | <b>NO-182</b> | 25 mm |
| Fig. 14 | <b>NO-183</b> | 30 mm |
| Fig. 15 | <b>NO-184</b> | 35 mm |
| Fig. 16 | <b>NO-185</b> | 40 mm |

**Sharp Malleable**

|         |               |       |
|---------|---------------|-------|
| Fig. 00 | <b>NO-186</b> | 5 mm  |
| Fig. 0  | <b>NO-187</b> | 6 mm  |
| Fig. 1  | <b>NO-188</b> | 7 mm  |
| Fig. 2  | <b>NO-189</b> | 8 mm  |
| Fig. 3  | <b>NO-190</b> | 9 mm  |
| Fig. 4  | <b>NO-191</b> | 11 mm |
| Fig. 5  | <b>NO-192</b> | 12 mm |
| Fig. 6  | <b>NO-193</b> | 14 mm |
| Fig. 7  | <b>NO-194</b> | 15 mm |
| Fig. 8  | <b>NO-195</b> | 16 mm |
| Fig. 9  | <b>NO-196</b> | 19 mm |
| Fig. 10 | <b>NO-197</b> | 20 mm |
| Fig. 11 | <b>NO-198</b> | 21 mm |
| Fig. 12 | <b>NO-199</b> | 23 mm |
| Fig. 13 | <b>NO-200</b> | 25 mm |
| Fig. 14 | <b>NO-201</b> | 30 mm |
| Fig. 15 | <b>NO-202</b> | 35 mm |
| Fig. 16 | <b>NO-203</b> | 40 mm |

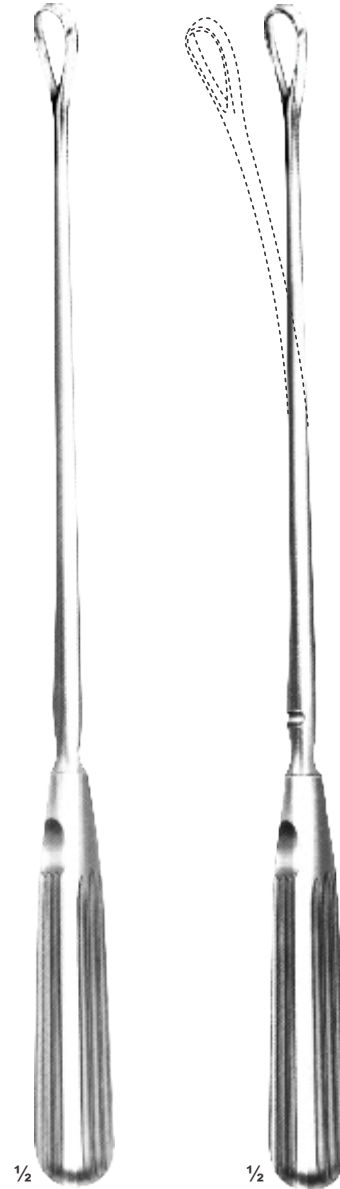

**Blunt Rigid**

|         |               |       |
|---------|---------------|-------|
| Fig. 00 | <b>NO-204</b> | 5 mm  |
| Fig. 0  | <b>NO-205</b> | 6 mm  |
| Fig. 1  | <b>NO-206</b> | 7 mm  |
| Fig. 2  | <b>NO-207</b> | 8 mm  |
| Fig. 3  | <b>NO-208</b> | 9 mm  |
| Fig. 4  | <b>NO-209</b> | 11 mm |
| Fig. 5  | <b>NO-210</b> | 12 mm |
| Fig. 6  | <b>NO-211</b> | 14 mm |
| Fig. 7  | <b>NO-212</b> | 15 mm |
| Fig. 8  | <b>NO-213</b> | 16 mm |
| Fig. 9  | <b>NO-214</b> | 19 mm |
| Fig. 10 | <b>NO-215</b> | 20 mm |
| Fig. 11 | <b>NO-216</b> | 21 mm |
| Fig. 12 | <b>NO-217</b> | 23 mm |
| Fig. 13 | <b>NO-218</b> | 25 mm |
| Fig. 14 | <b>NO-219</b> | 30 mm |
| Fig. 15 | <b>NO-220</b> | 35 mm |
| Fig. 16 | <b>NO-221</b> | 40 mm |

**Blunt Malleable**

|         |               |       |
|---------|---------------|-------|
| Fig. 00 | <b>NO-222</b> | 5 mm  |
| Fig. 0  | <b>NO-223</b> | 6 mm  |
| Fig. 1  | <b>NO-224</b> | 7 mm  |
| Fig. 2  | <b>NO-225</b> | 8 mm  |
| Fig. 3  | <b>NO-226</b> | 9 mm  |
| Fig. 4  | <b>NO-227</b> | 11 mm |
| Fig. 5  | <b>NO-228</b> | 12 mm |
| Fig. 6  | <b>NO-229</b> | 14 mm |
| Fig. 7  | <b>NO-230</b> | 15 mm |
| Fig. 8  | <b>NO-231</b> | 16 mm |
| Fig. 9  | <b>NO-232</b> | 19 mm |
| Fig. 10 | <b>NO-233</b> | 20 mm |
| Fig. 11 | <b>NO-234</b> | 21 mm |
| Fig. 12 | <b>NO-235</b> | 23 mm |
| Fig. 13 | <b>NO-236</b> | 25 mm |
| Fig. 14 | <b>NO-237</b> | 30 mm |
| Fig. 15 | <b>NO-238</b> | 35 mm |
| Fig. 16 | <b>NO-239</b> | 40 mm |

Recamier  
**NO-168 - 185**  
Sharp, rigid

Recamier  
**NO-186 - 203**  
Sharp, malleable

Sims  
**NO-204 - 221**  
Blunt, rigid

Sims  
**NO-222 - 239**  
Blunt, malleable