

Page 01-16

- Gall Bladder, Liver and Spleen Instruments
- Genito Urinary Instruments

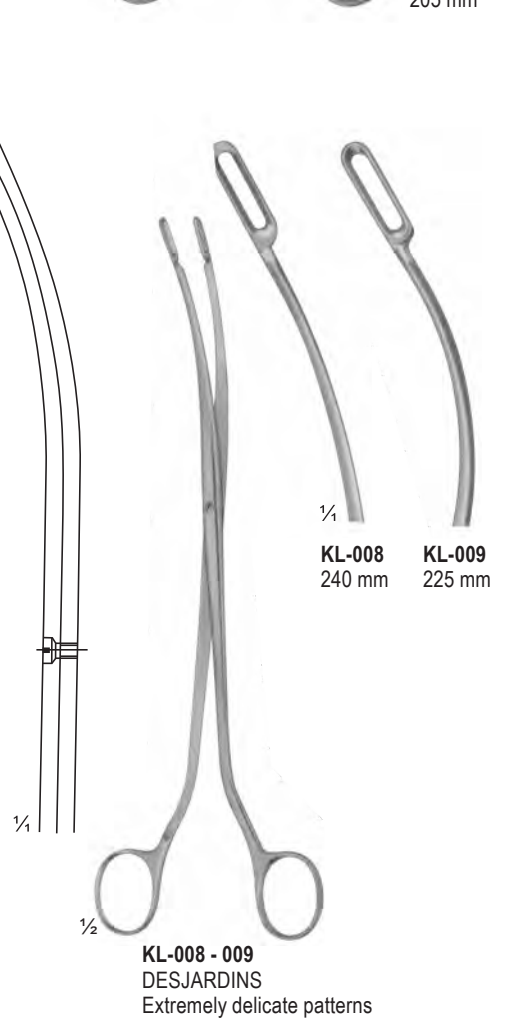

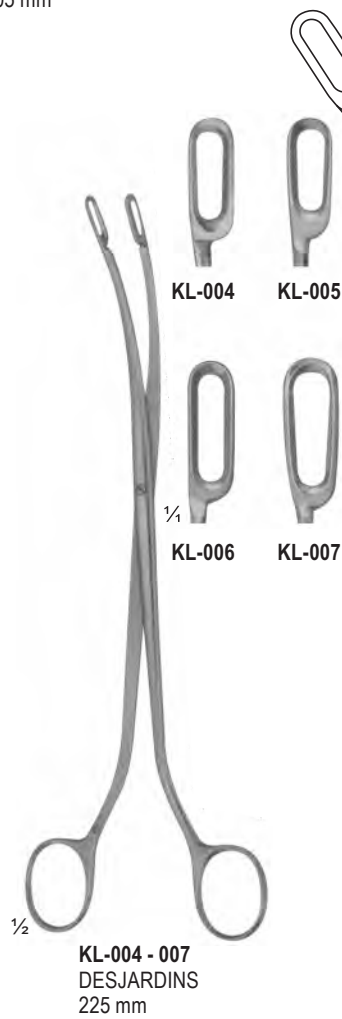
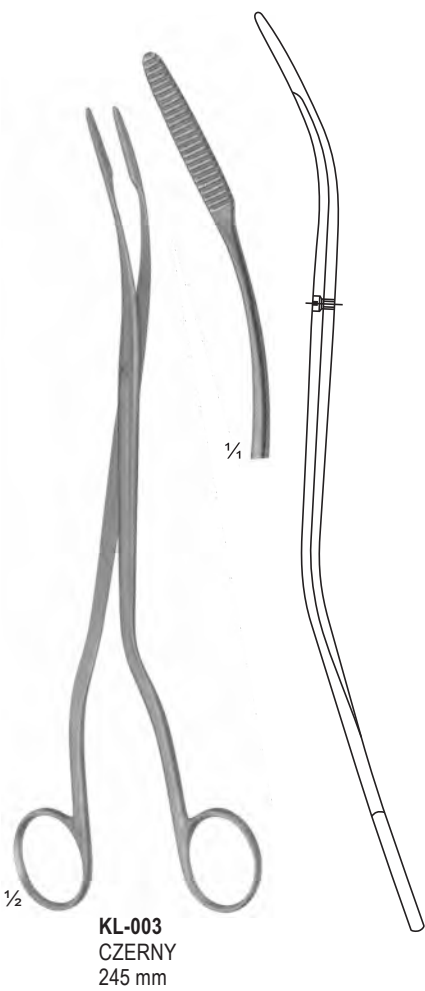
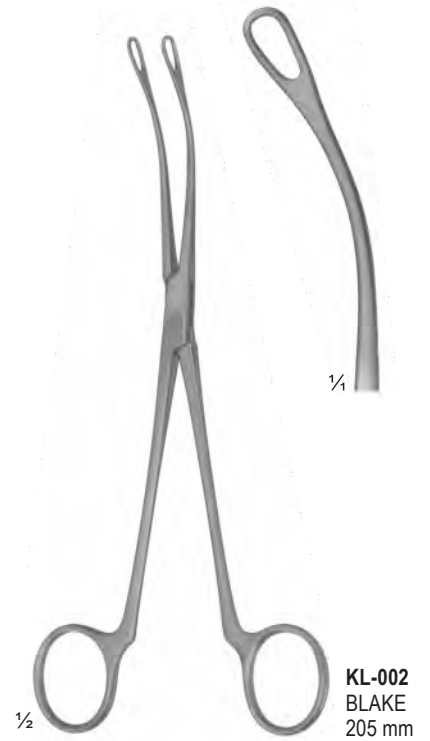
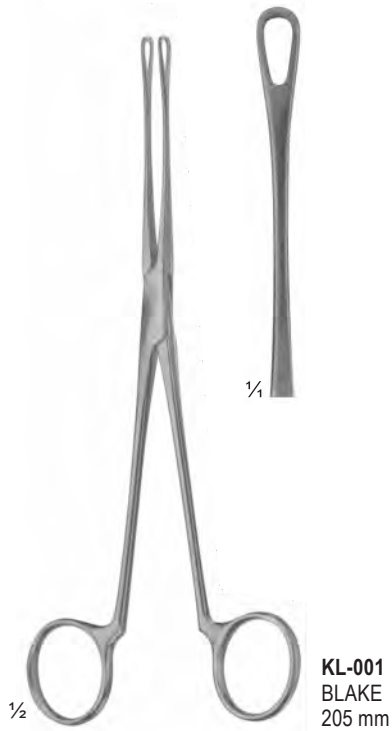

KIDNEY STONE FORCEPS



KL-010



KL-011



KL-012



1/4
KL-013



KL-014



KL-015



1/4
KL-016



1/2

KL-010 - 013
RANDALL
225 mm

1/2

KL-014 - 016
RANDALL
190 mm

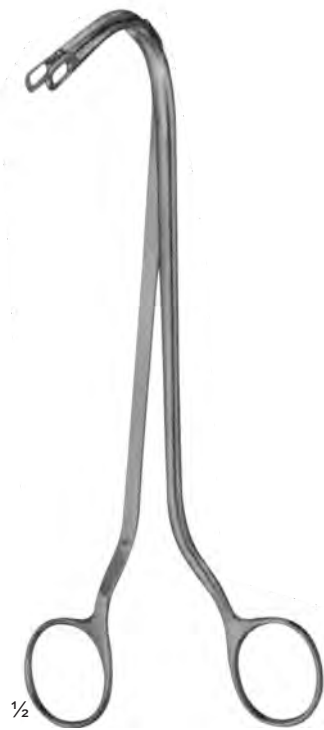
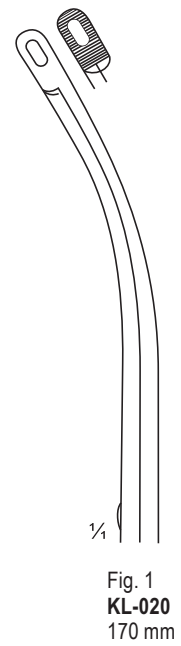
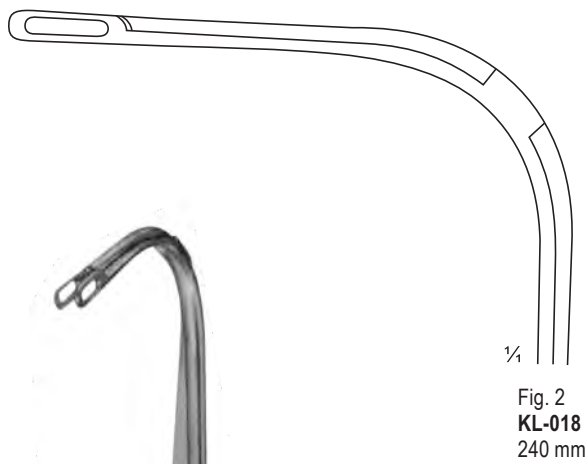
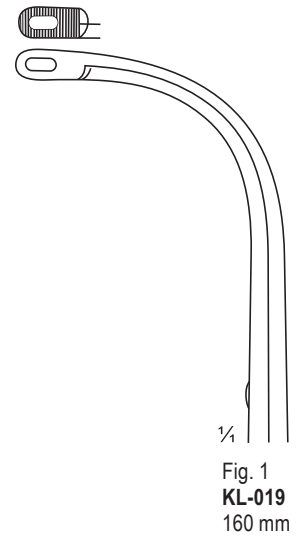
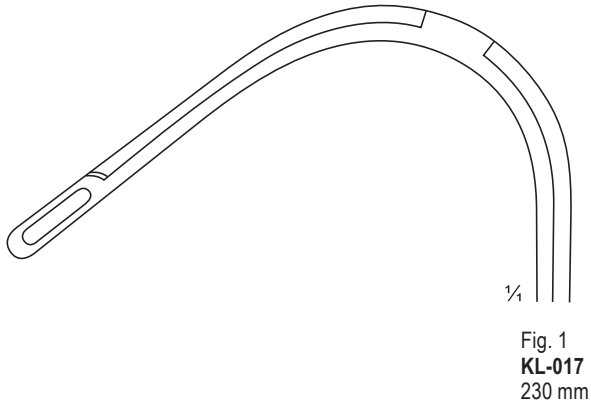

RANDALL
KL-017 - 018



HEIMING
KL-019 - 020



NEPHROSTOMY FORCEPS

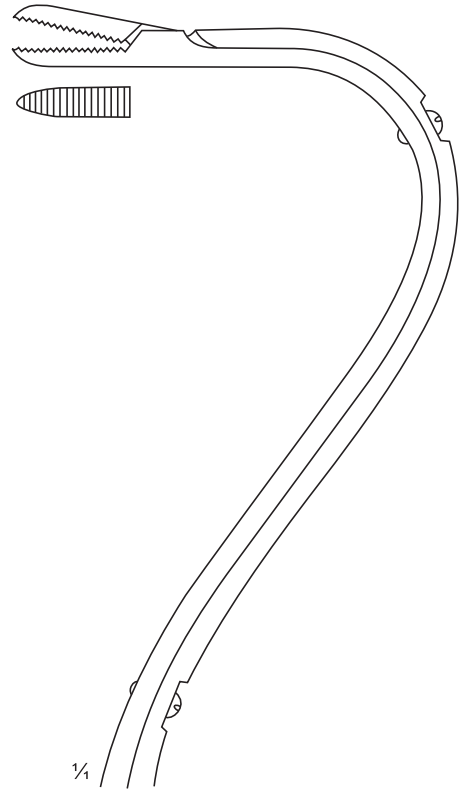

Fig. 1
KL-021



ELSÄSSER
KL-021 - 022
210 mm

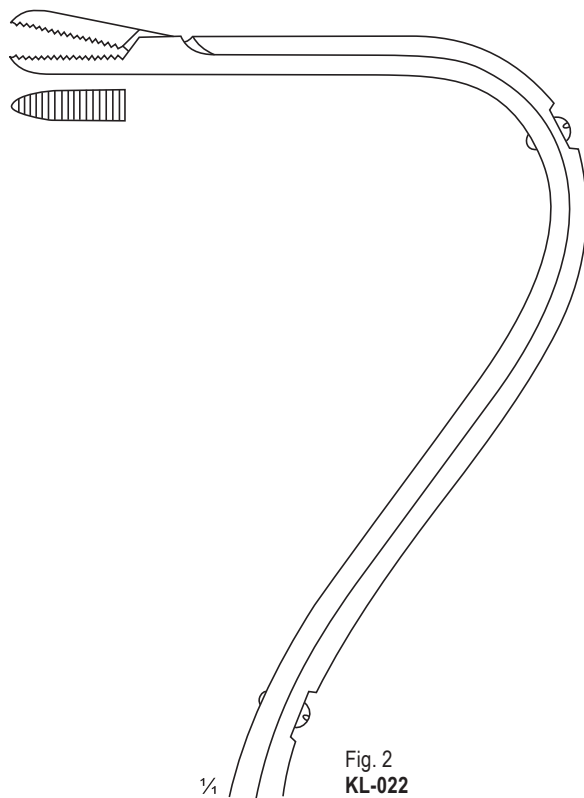
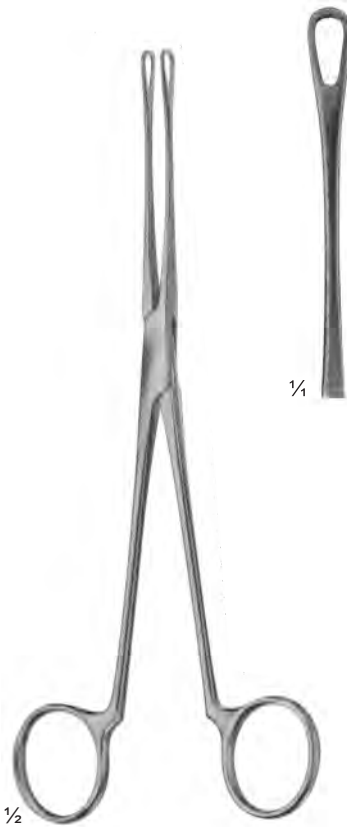

Fig. 2
KL-022



1/4

1/2

**BLAKE
KL-023**
205 mm

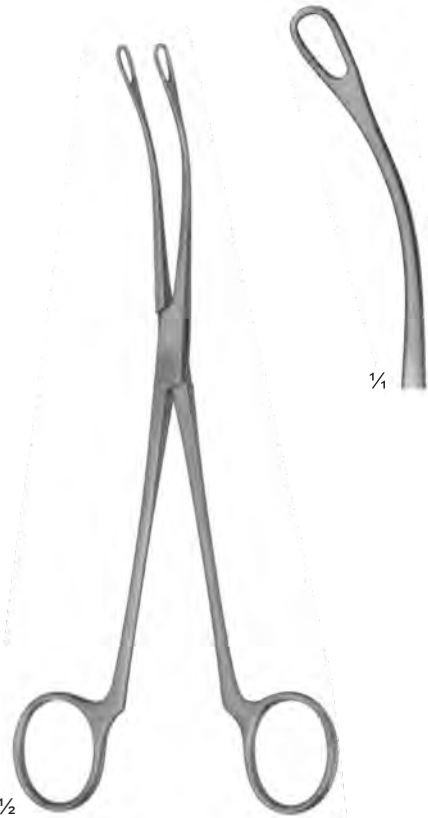

1/4

1/2

**BLAKE
KL-024**
205 mm



1/4

**MAYO-BLAKE
KL-025**
210 mm



1/4

1/2

**MAYO-BLAKE
KL-026**
210 mm

GALL STONE, CAPSULE FORCEPS

ATRAUMA



MILLIN
Lobe grasping forceps
KL-027
235 mm

ATRAUMA



MILLIN
Lobe grasping forceps
KL-028
245 mm



MILLIN
Ligature holding forceps
KL-029
245 mm



LEGUEU
KL-030
270 mm



KOCHER
KL-031
260 mm



KOCHER
KL-032
260 mm



PROSTATIC RETRACTORS

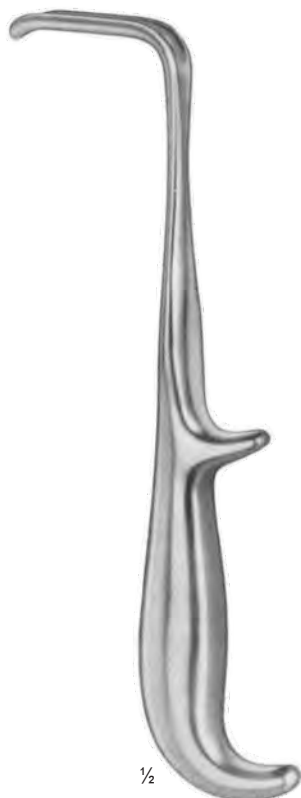

YOUNG
KL-033
210 mm



YOUNG
KL-034
220 mm



YOUNG
KL-035
210 mm



YOUNG
KL-036
220 mm



SPERMATIC
KL-037
160 mm

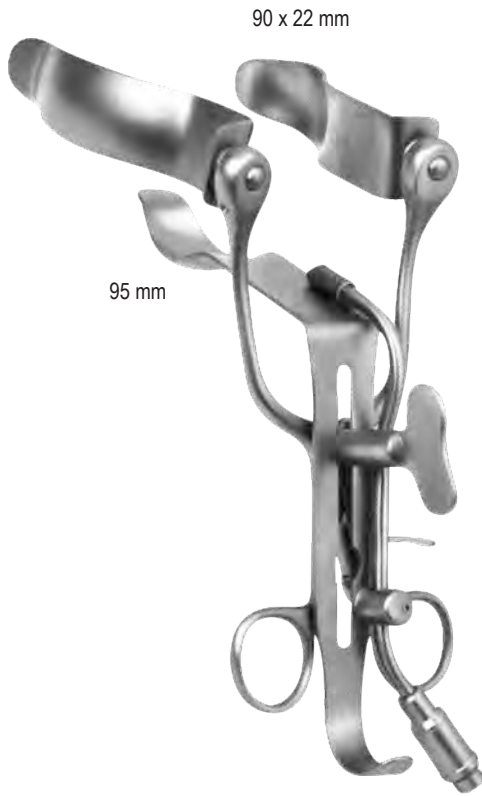

ALAN-PARKS
KL-038
150 mm

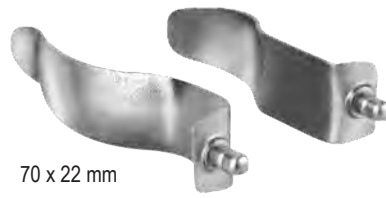

FIBER OPTIC
KL-039



ALAN-PARKS
KL-040
150 mm



GALL DUCT PROBES

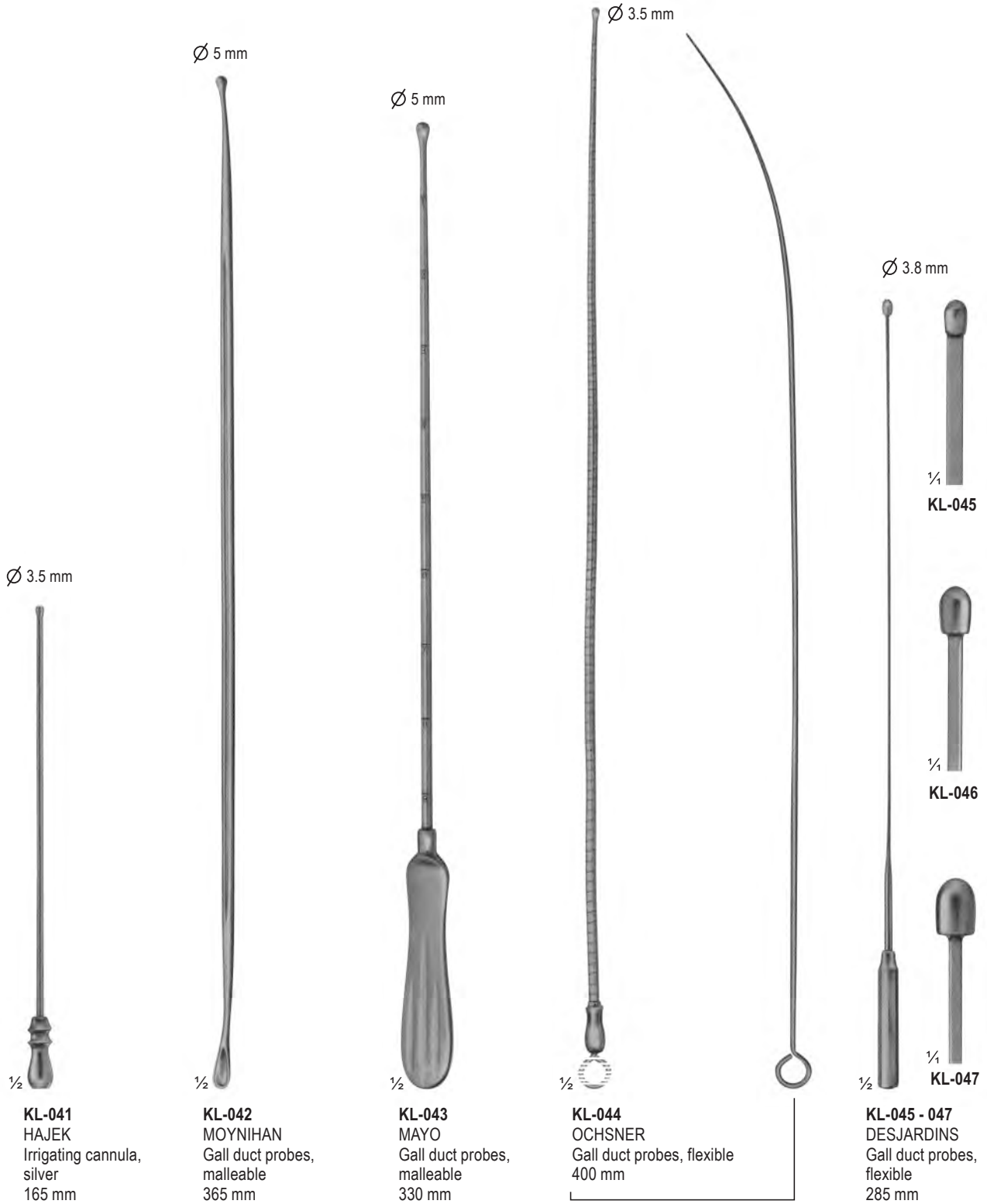

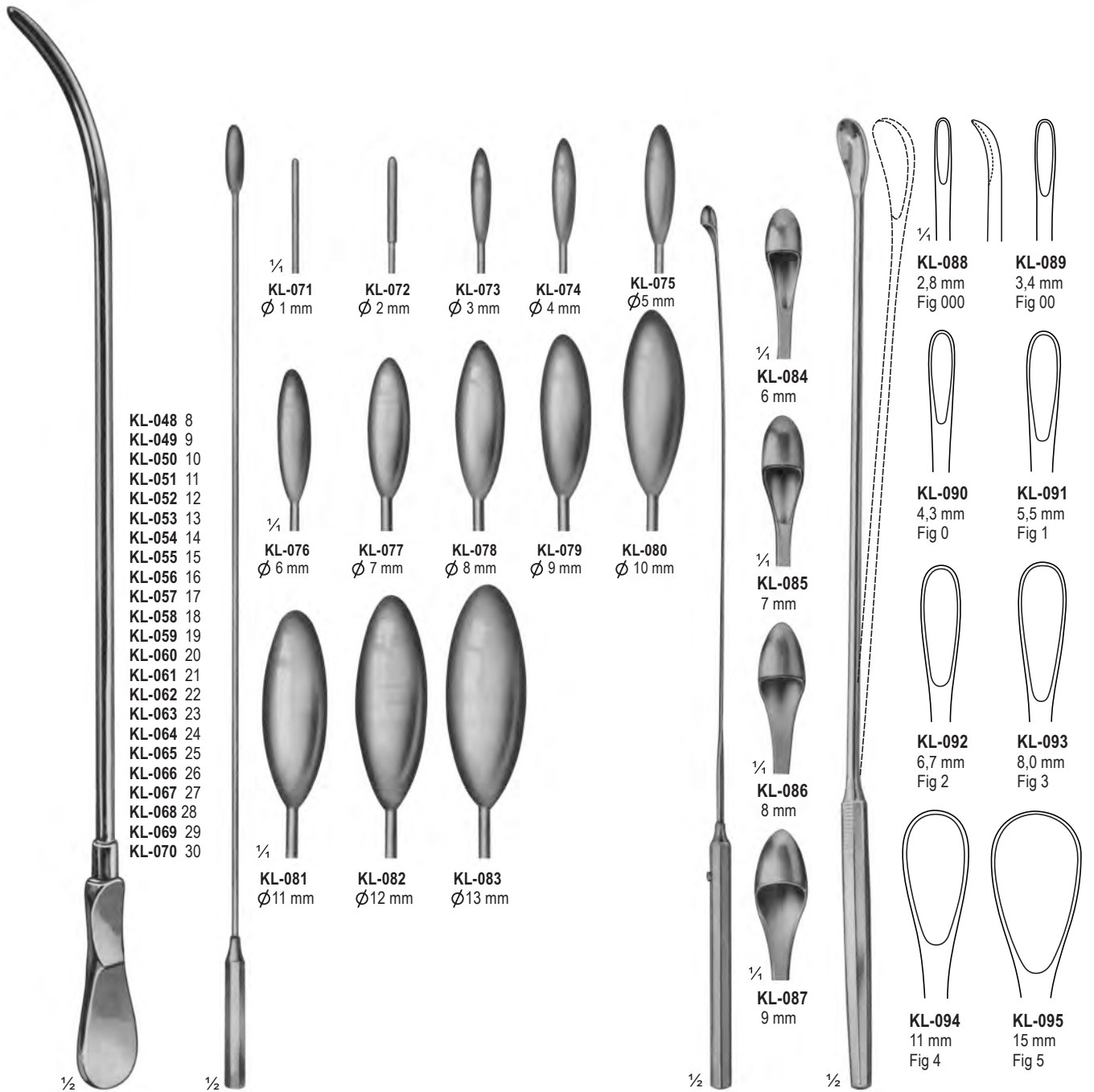

KL-048 - 070
 DITTEL
 Metall bougies and
 dilating sounds, stiff
 345 mm

KL-071 - 083
 BAKES
 Common bile duct
 dilators, malleable
 315 mm, 320 mm

KL-084 - 087
 DESJARDINS
 Probes and catch
 with flexible shaft
 300 mm

KL-088 - 095
 LUER-KORTE modif
 with malleable shaft
 310 mm



BLADDER RETRACTORS



Legueu
KL-096
Center blade
80 x 31 mm



Judd-Masson
KL-097
Spreading
120 mm



Judd-Masson
KL-098
Self-retaining with swivel blade 70 x 25 mm
and center blade 70 mm deep
opening 10 cm



Judd-Masson
KL-099
Self-retaining with swivel blade,
cross bar 16.8 cm, Blade depth 6.9 cm.
Arm length 13 cm



- KL-100 8 Charr.
- KL-101 10 Charr.
- KL-102 12 Charr.
- KL-103 14 Charr.
- KL-104 16 Charr.
- KL-105 18 Charr.
- KL-106 20 Charr.
- KL-107 22 Charr.
- KL-108 24 Charr.
- KL-109 26 Charr.
- KL-110 28 Charr.
- KL-111 30 Charr.
- KL-112 32 Charr.
- KL-113 34 Charr.
- KL-114 36 Charr.

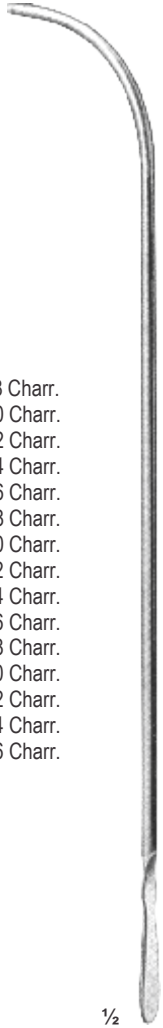

Van Buren
KL-100 - 114
27 cm

KL-100-114
complete set, 8 - 36 Charrière

- KL-115 10 Charr.
- KL-116 11 Charr.
- KL-117 12 Charr.
- KL-118 13 Charr.
- KL-119 14 Charr.
- KL-120 15 Charr.
- KL-121 16 Charr.
- KL-122 17 Charr.
- KL-123 18 Charr.
- KL-124 19 Charr.
- KL-125 20 Charr.
- KL-126 21 Charr.
- KL-127 22 Charr.
- KL-128 23 Charr.
- KL-129 24 Charr.
- KL-130 25 Charr.
- KL-131 26 Charr.
- KL-132 27 Charr.
- KL-133 28 Charr.
- KL-134 29 Charr.
- KL-135 30 Charr.

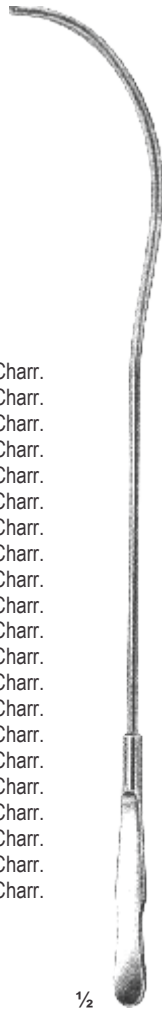

Guyon
KL-115 - 135
26.5 cm

KL-115 - 135
complete set, 10 - 29 Charrière

- KL-136 Ben. 24/Charr. 12
- KL-137 Ben. 26/Charr. 13
- KL-138 Ben. 28/Charr. 14
- KL-139 Ben. 30/Charr. 15
- KL-140 Ben. 32/Charr. 16
- KL-141 Ben. 34/Charr. 17
- KL-142 Ben. 36/Charr. 18
- KL-143 Ben. 38/Charr. 19
- KL-144 Ben. 40/Charr. 20
- KL-145 Ben. 42/Charr. 21
- KL-146 Ben. 44/Charr. 22
- KL-147 Ben. 46/Charr. 23
- KL-148 Ben. 48/Charr. 24
- KL-149 Ben. 50/Charr. 25
- KL-150 Ben. 52/Charr. 26
- KL-151 Ben. 54/Charr. 27
- KL-152 Ben. 56/Charr. 28
- KL-153 Ben. 58/Charr. 29
- KL-154 Ben. 60/Charr. 30

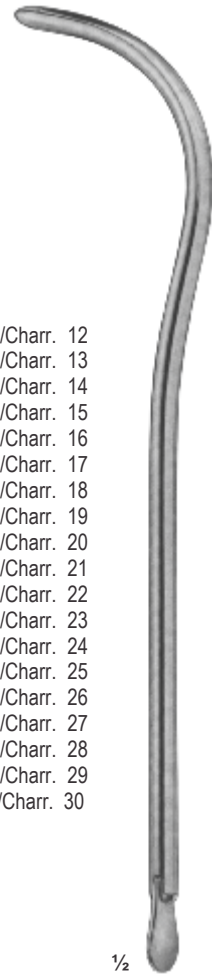

Guxon
KL-136 - 154
25.5 cm

Urethral bougies and dilating sounds, without filiform guide, with thread in tip

KL-136 - 154
complete set, 8 - 30 Charrière



CATHETERS

- KL-155** 6 Charr.
- KL-156** 10 Charr.
- KL-157** 12 Charr.
- KL-158** 14 Charr.
- KL-159** 16 Charr.



KL-155 - 159
15 cm
Metal Catheters, female

KL-155 - 159
complete set, 6 - 16 Charrière

- KL-160** 6 Charr.
- KL-161** 7 Charr.
- KL-162** 8 Charr.
- KL-163** 9 Charr.
- KL-164** 10 Charr.
- KL-165** 11 Charr.
- KL-166** 12 Charr.
- KL-167** 13 Charr.
- KL-168** 14 Charr.
- KL-169** 15 Charr.
- KL-170** 16 Charr.
- KL-171** 18 Charr.
- KL-172** 20 Charr.

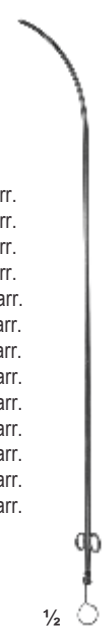

KL-160 - 172
16 cm
Metal Catheters, female

KL-160 - 172
complete set, 6 - 20 Charrière



Guyon
KL-173
36.5 cm
Catheter guide (introducer)

KL-174
39 cm
Straight

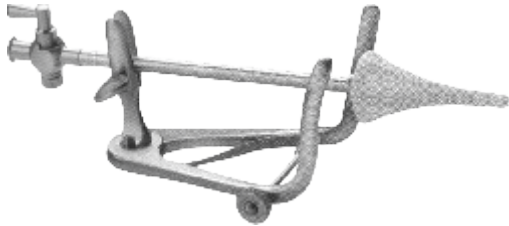

Knutson
KL-175
Urethrography Instrument

Knutson-Koch
KL-176
Cone, only

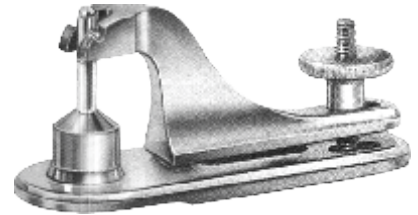

KL-177 - 183
Circumcision gomco clamp

- KL-177** \varnothing 8 mm
- KL-178** \varnothing 11 mm
- KL-179** \varnothing 13 mm
- KL-180** \varnothing 16 mm
- KL-181** \varnothing 21 mm
- KL-182** \varnothing 26 mm
- KL-183** \varnothing 32 mm

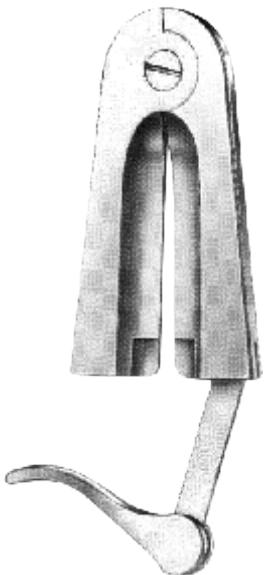

Mogen
KL-184
7.5 cm
Circumcision clamp



Stockmann
KL-185
8 cm
Penis clamp

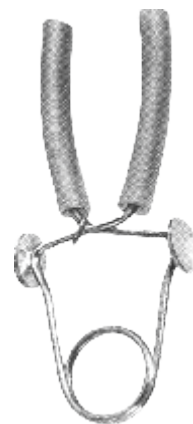

Strauss
KL-186
11 cm
Penis clamp