

Page
01-49

○ Scissors

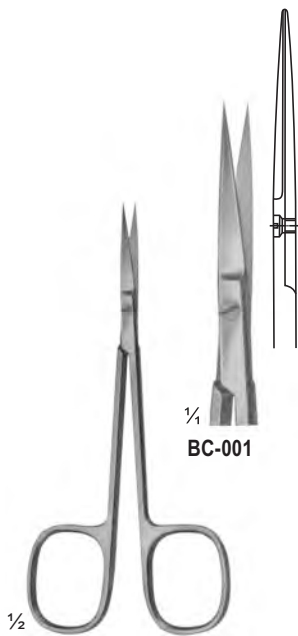

BC-001



BC-002

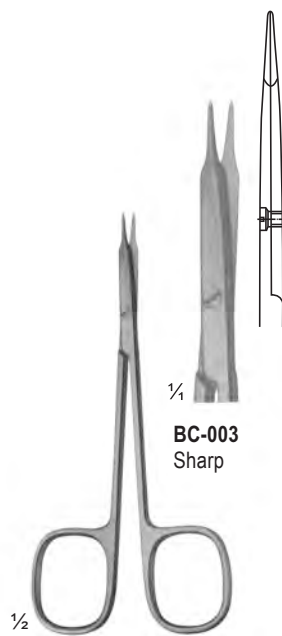

BC-003
Sharp



BC-004
Sharp

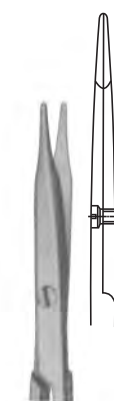

BC-005
Blunt



BC-006
Blunt

BC-001 - 002
120 mm

BC-003 - 006
STEVENS
Dissecting Scissors
115 mm

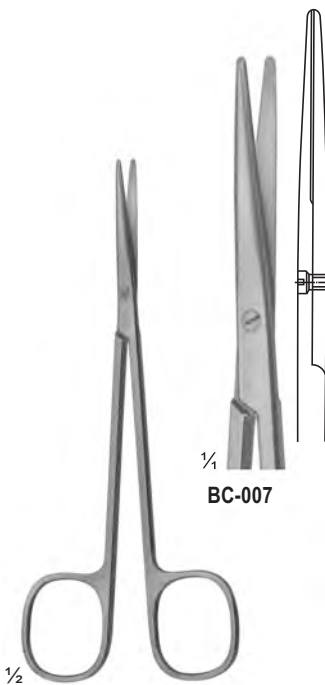

BC-007

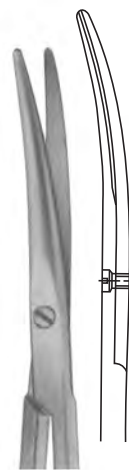

BC-008

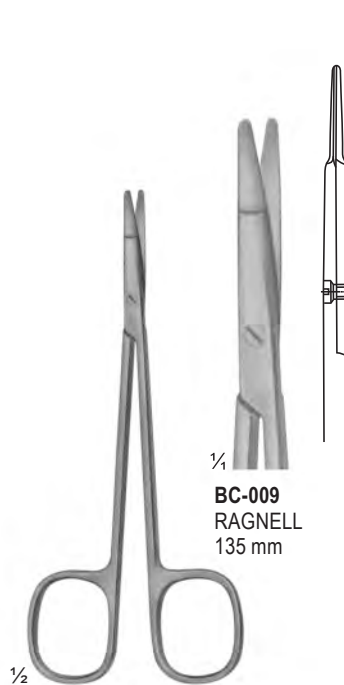

BC-009
RAGNELL
135 mm

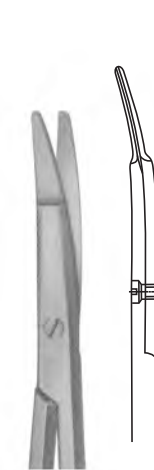

BC-010
RAGNELL
135 mm

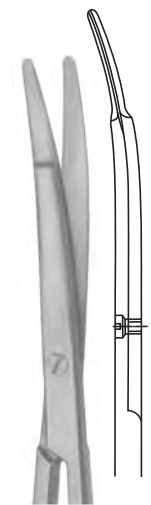

BC-011
150 mm

BC-007 - 008
METZENBAUM
Dissecting Scissors
145 mm

BC-009 - 011
Special flat points for
dissecting and
undermining the skin
145 mm



DELICATE SCISSORS

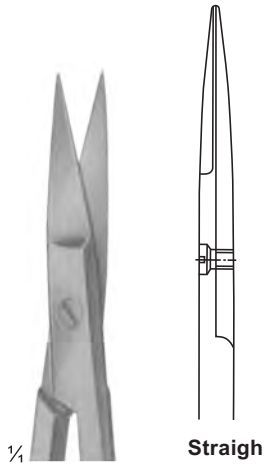

Straight

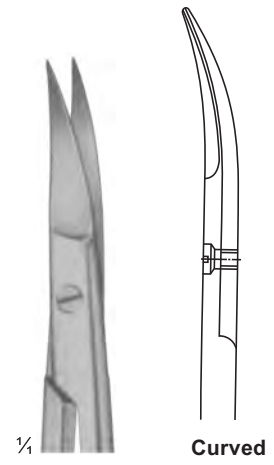

Curved

KELLY
BC-012
175 mm
BC-012-1
155 mm

KELLY
BC-013
175 mm
BC-013-1
155 mm

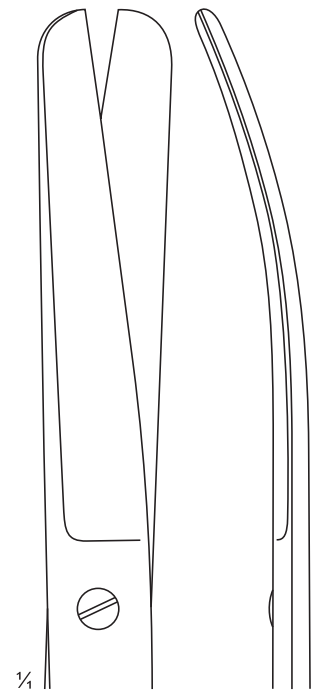
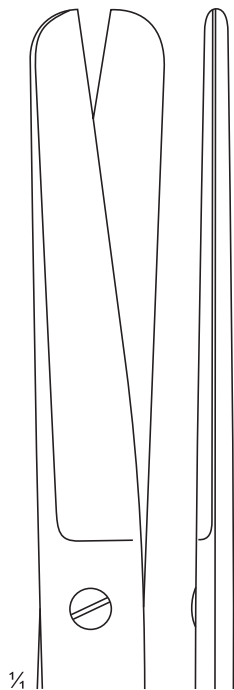

DOYEN
BC-014
185 mm

DOYEN
BC-015
185 mm

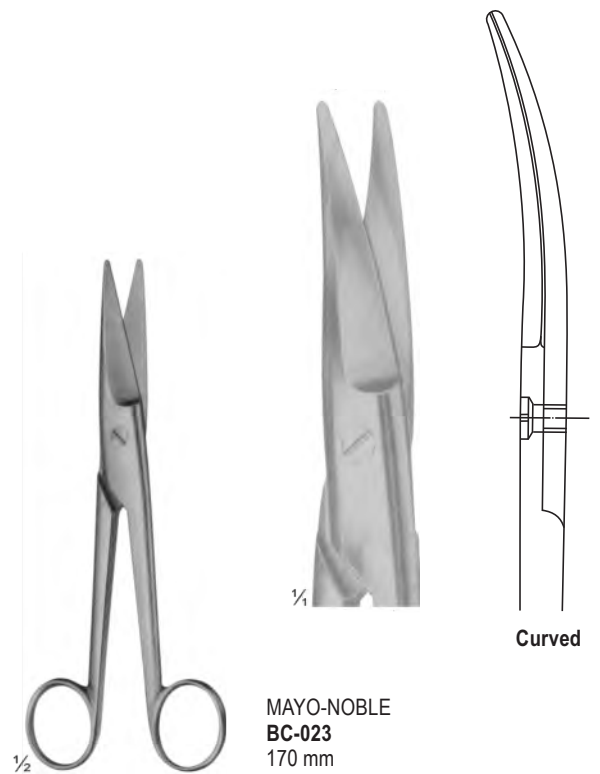
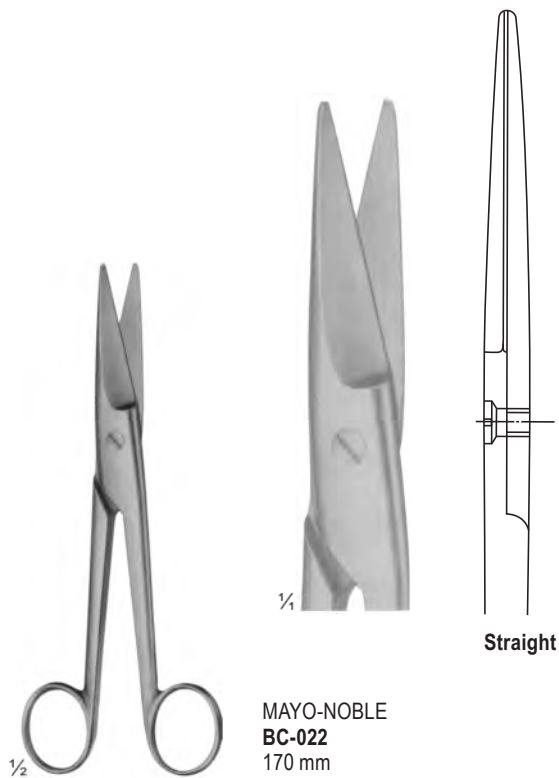
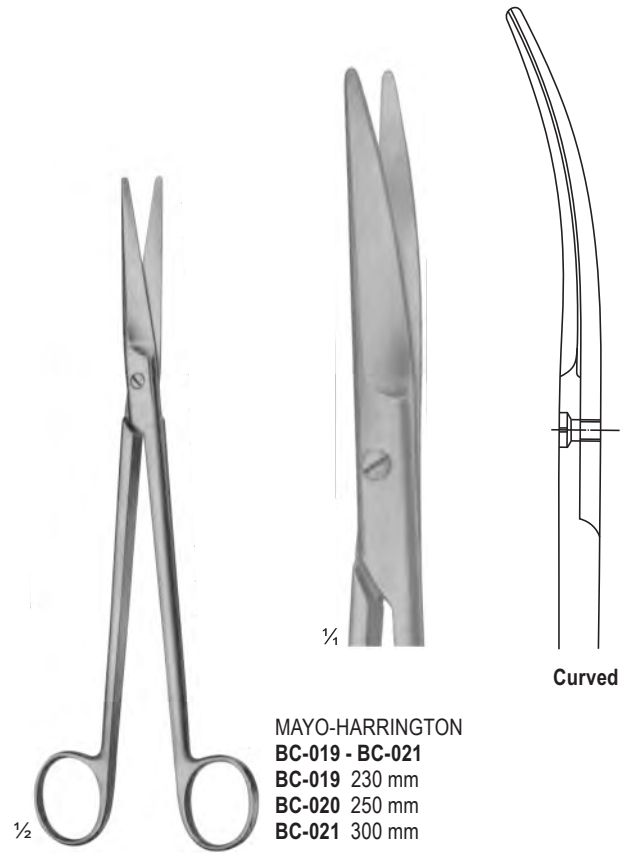
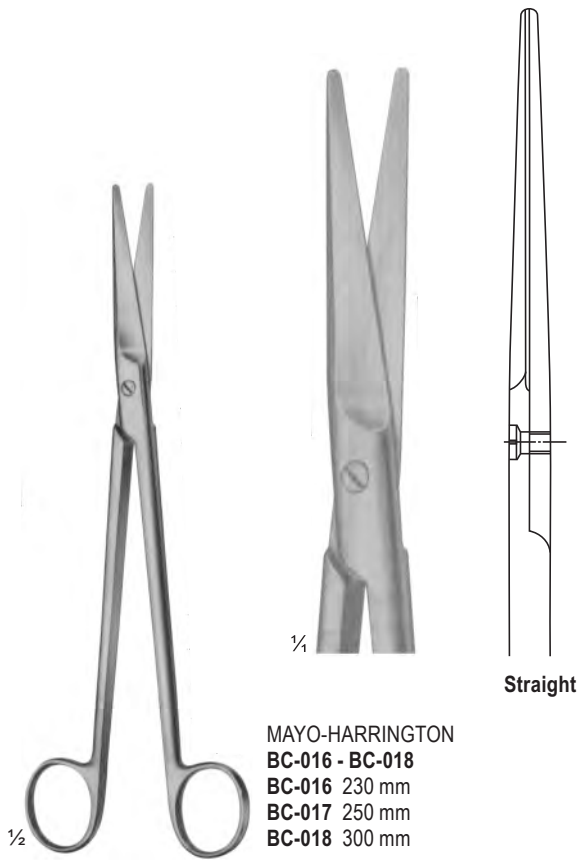



OPERATING AND GYNAECOLOGY SCISSORS



Curved

1/2

SIMS
BC-024 - BC-026
BC-024 200 mm
BC-025 210 mm
BC-026 230 mm



Curved

1/2

WERTHEIM
BC-027 - BC-029
BC-027 145 mm
BC-028 200 mm
BC-029 230 mm

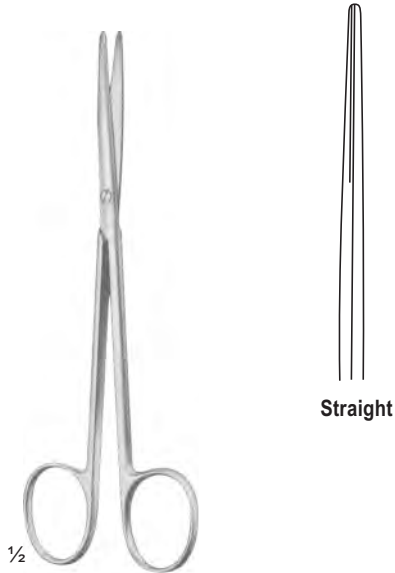

FINO-METZENBAUM
BC-030 - BC-035
BC-030 180 mm
BC-031 200 mm
BC-032 230 mm
BC-033 260 mm
BC-034 280 mm
BC-035 300 mm

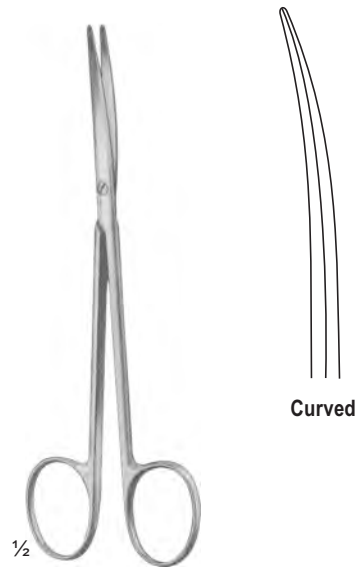

FINO-METZENBAUM
BC-036 - BC-041
BC-036 180 mm
BC-037 200 mm
BC-038 230 mm
BC-039 260 mm
BC-040 280 mm
BC-041 300 mm



VESSEL SCAISSORS

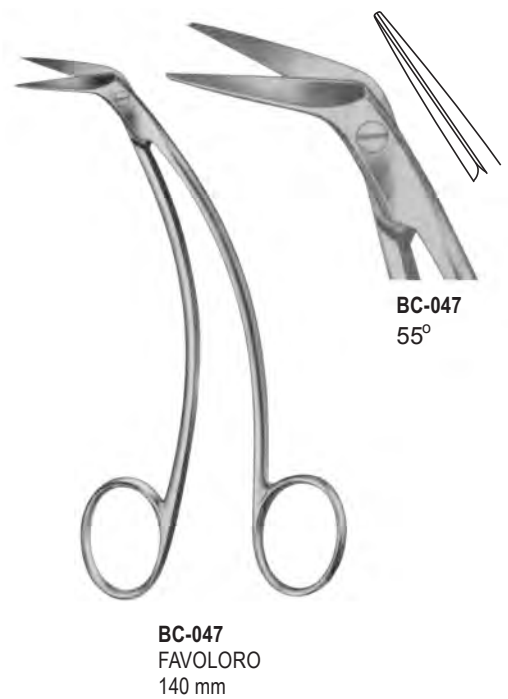
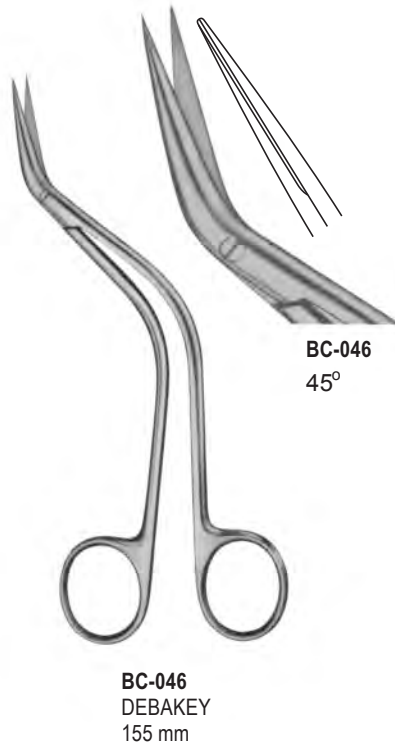
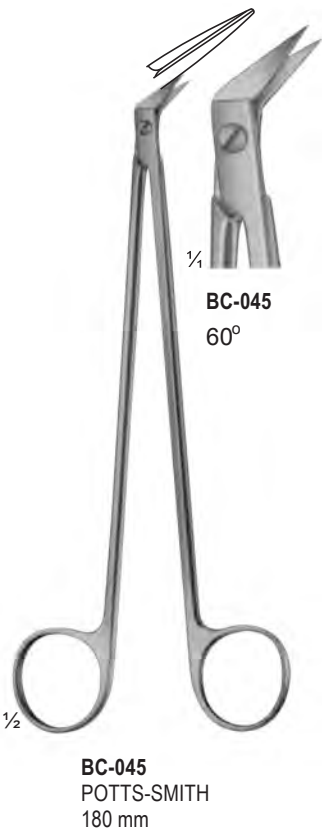
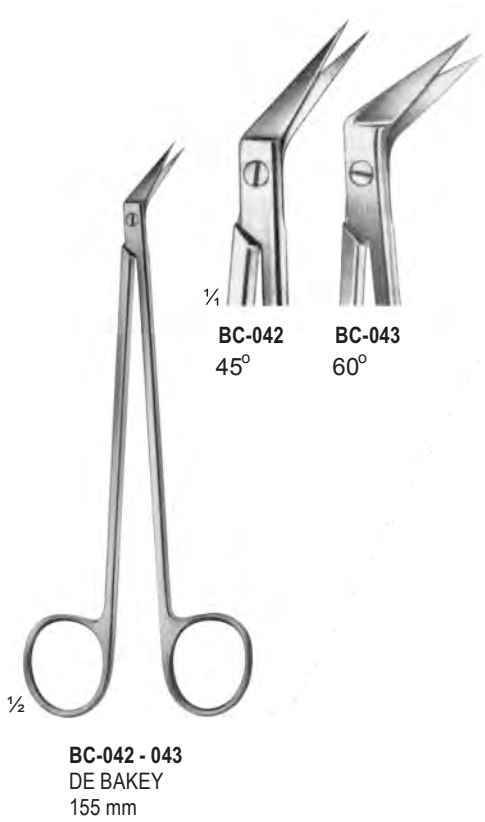

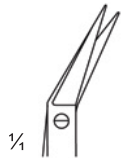

BC-048
190 mm
25°



BC-049
185 mm
45°



BC-050
175 mm
60°

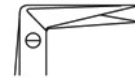

BC-051
175 mm
90°



BC-052
175 mm
120°

DIETHRICH
BC-048 - 052



BC-053
25°



BC-054
45°



BC-055
60°



BC-056
90°



BC-057
120°

MIKRO-HEGEMANN
BC-053 - 057
185 mm



DELICATE SCISSORS

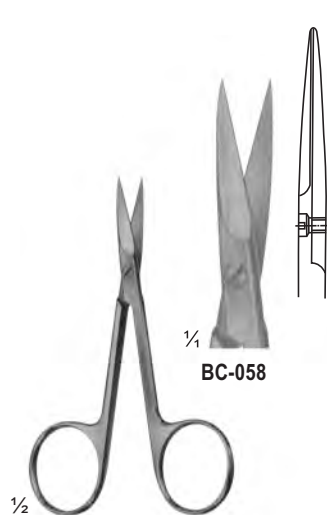

BC-058



BC-059

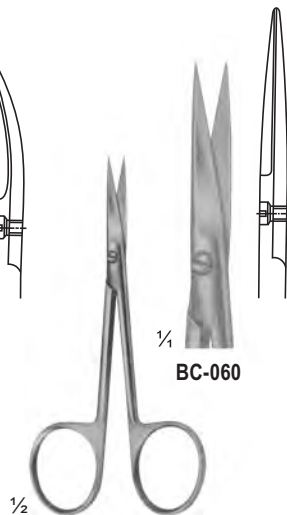

BC-060



BC-061

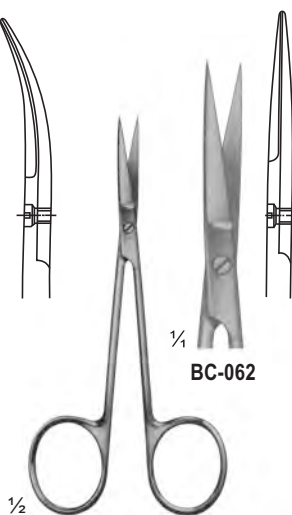

BC-062



BC-063

BC-058 - 059
Cutical
90 mm

BC-060 - 061
Iris
95 mm

BC-062 - 063
Iris
100 mm

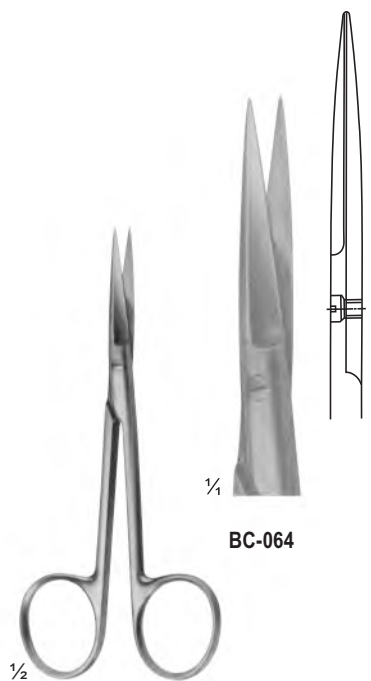

1/4

BC-064



BC-065

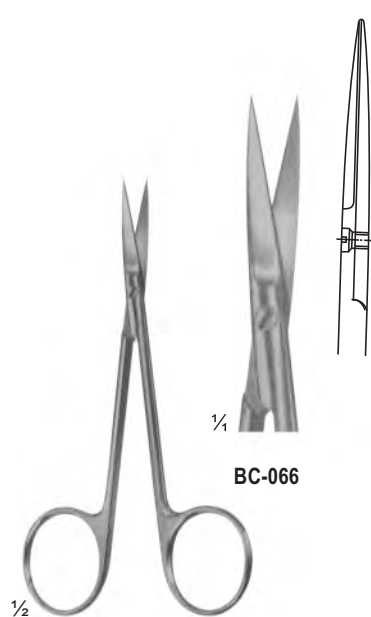

1/4

BC-066



BC-067

BC-064 - 065
Wagner
130 mm

BC-066 - 067
Iris
110 mm



BC-068 - 070
Fine Operating Scissors
120 mm

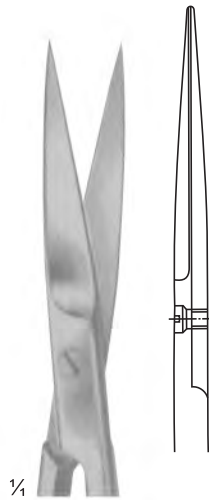

BC-068

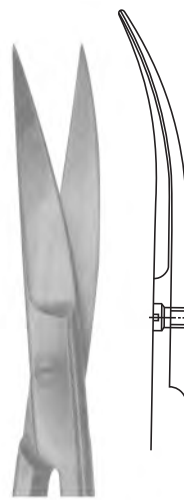

BC-069

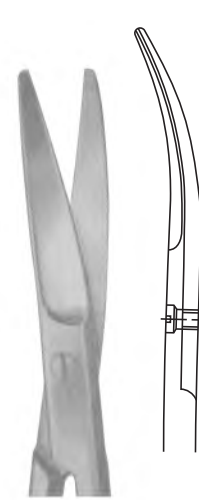

BC-070



BC-071 - 074
Fine Operating Scissors
130 mm

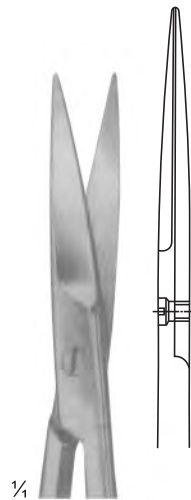

BC-071

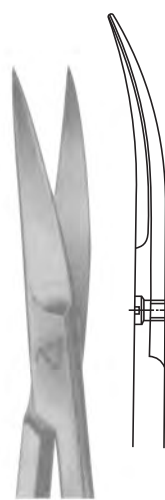

BC-072

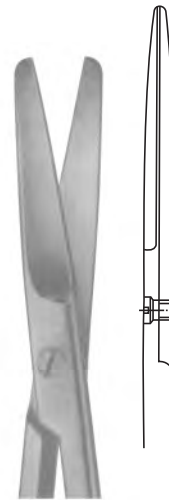

BC-073

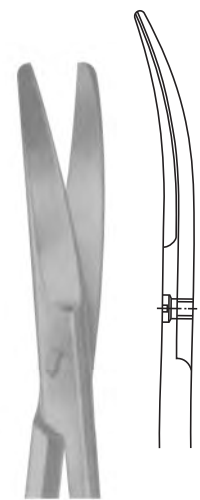

BC-074



DELICATE SCISSORS

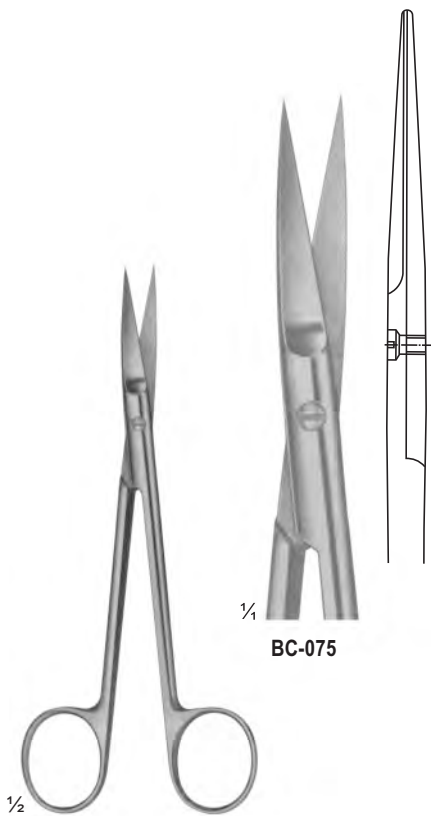

BC-075

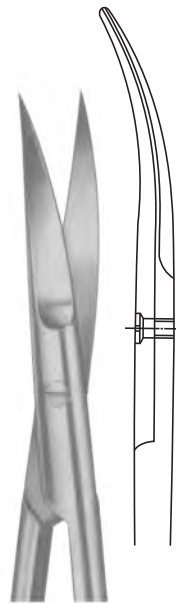

BC-076

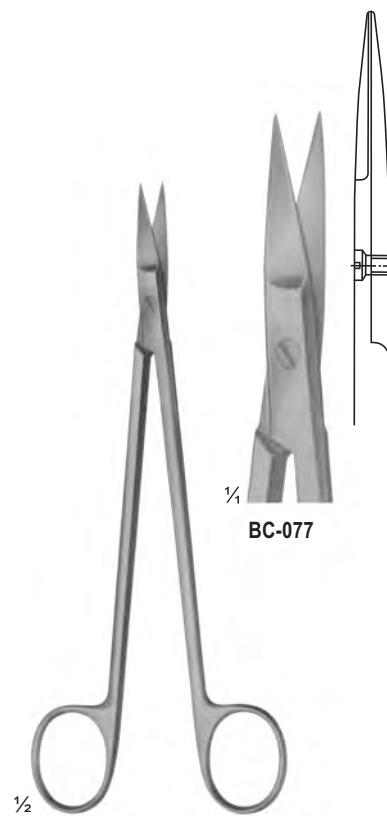

BC-077

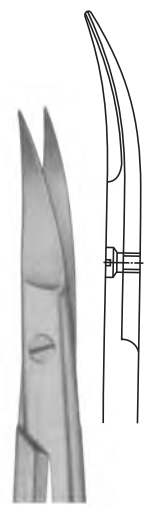

BC-078

BC-075 - 076
JOSEPH
150 mm

BC-077 - 078
KELLY
175 mm

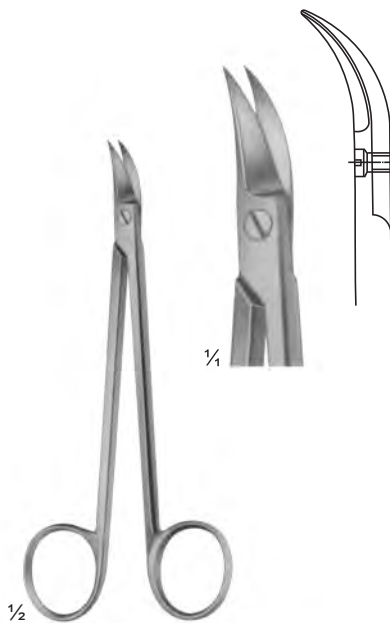

BC-079
QUINBY
130 mm

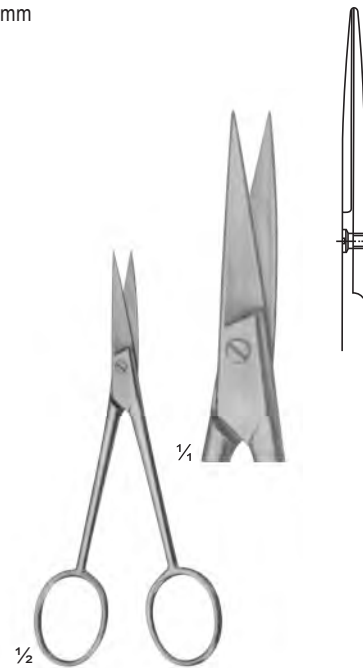

BC-080
Dissecting
110 mm

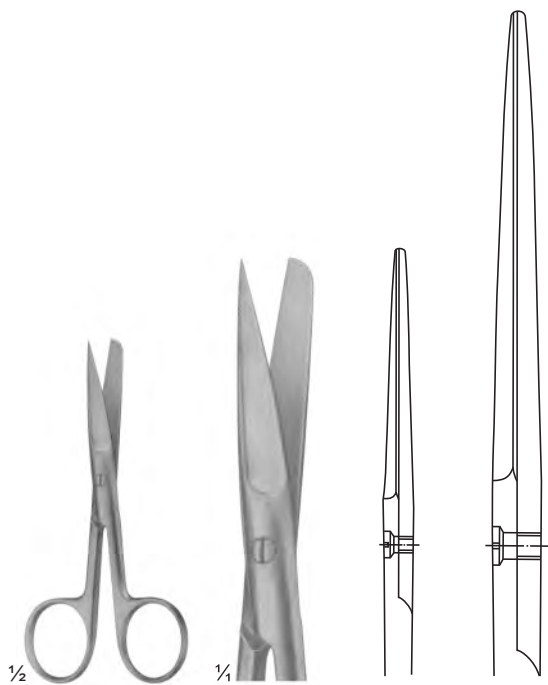

BC-081 - 089 (Standard Types)

- BC-081 (105 mm)
- BC-082 (115 mm)
- BC-083 (130 mm)
- BC-084 (145 mm)
- BC-085 (150 mm)
- BC-086 (165 mm)
- BC-087 (175 mm)
- BC-088 (185 mm)
- BC-089 (200 mm)

BC-081
105 mm

BC-089
200 mm

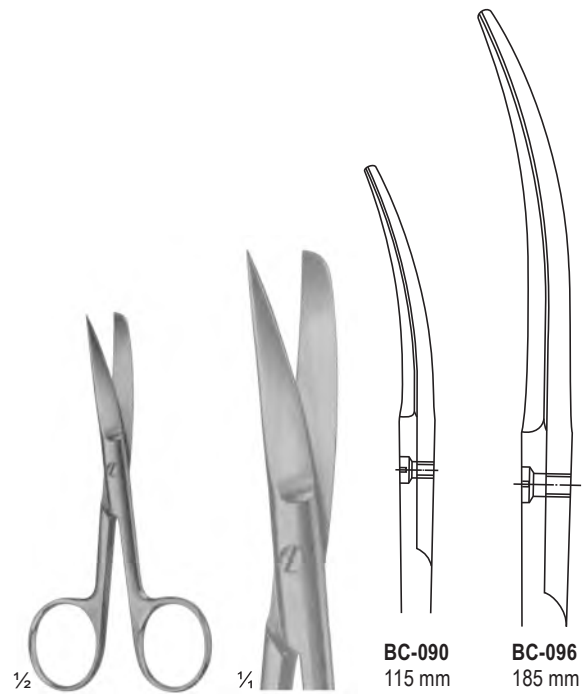

BC-090 - 095 (Standard Types)

- BC-090 (115 mm)
- BC-091 (130 mm)
- BC-092 (145 mm)
- BC-093 (150 mm)
- BC-094 (165 mm)
- BC-095 (175 mm)
- BC-096 (185 mm)

BC-090
115 mm

BC-096
185 mm

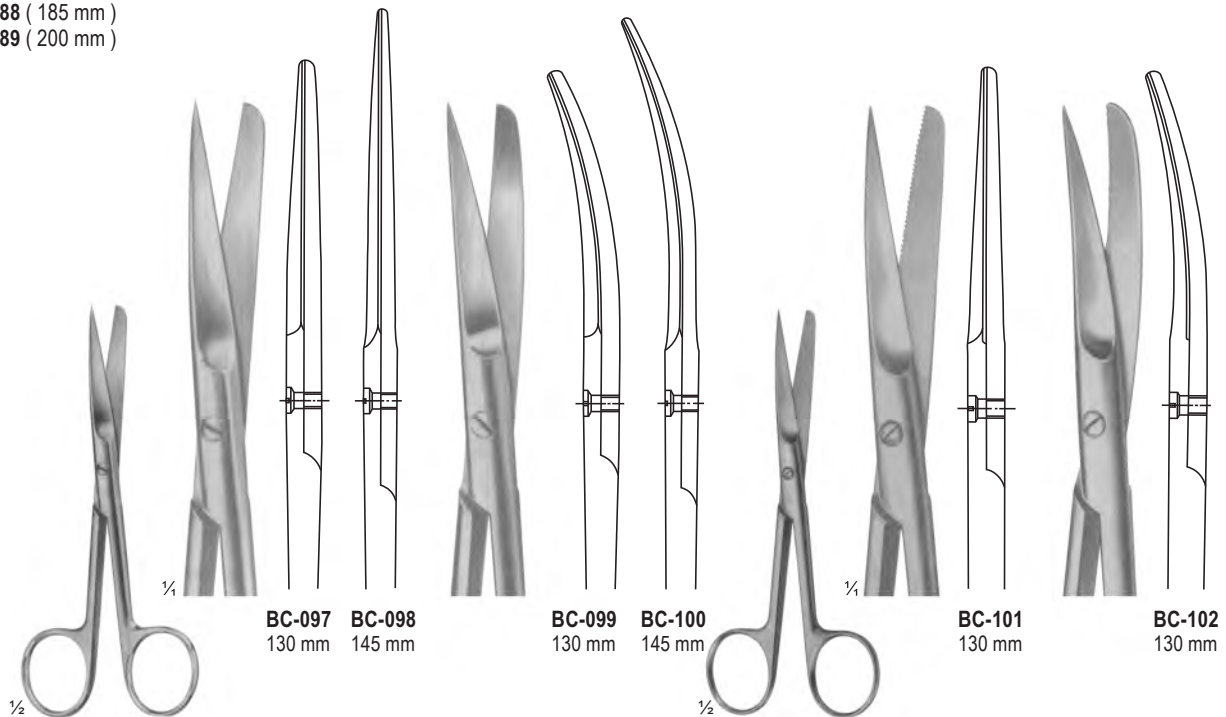

BC-097 - 100
Slender Types

BC-097 130 mm
BC-098 145 mm

BC-099 130 mm
BC-100 145 mm

BC-101 - 102
For Wound Edges
1 Blade Serrated

BC-101
130 mm

BC-102
130 mm

SURGICAL SCISSORS

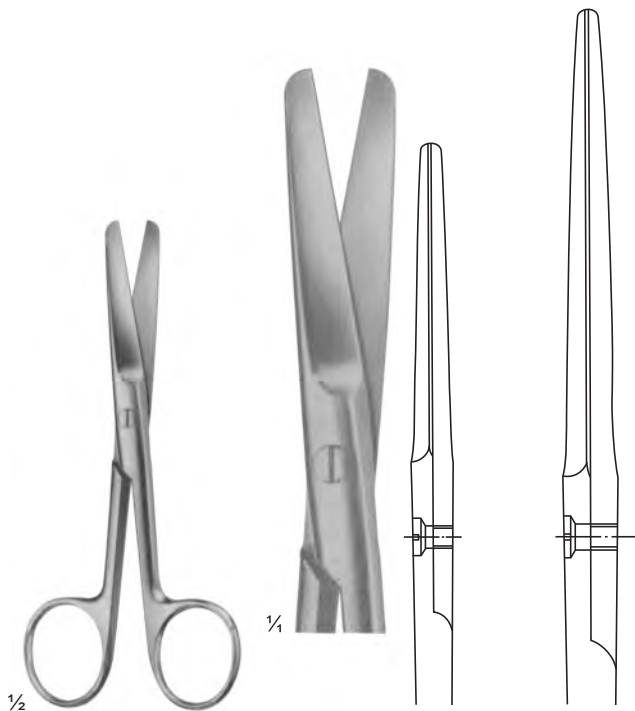

BC-103 - 107 (Standard Types)
BC-103 (130 mm)
BC-104 (145 mm)
BC-105 (150 mm)
BC-106 (165 mm)
BC-107 (175 mm)

BC-103
 130 mm

BC-107
 175 mm

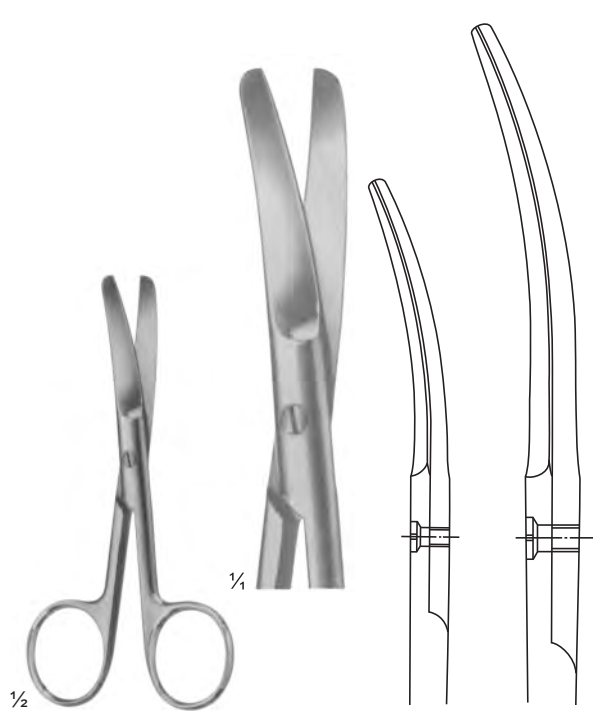

BC-108 - 113 - COOPER
 Standard Types
BC-108 (115 mm)
BC-109 (130 mm)
BC-110 (145 mm)
BC-111 (150 mm)
BC-112 (165 mm)
BC-113 (175 mm)

BC-108
 115 mm

BC-113
 175 mm

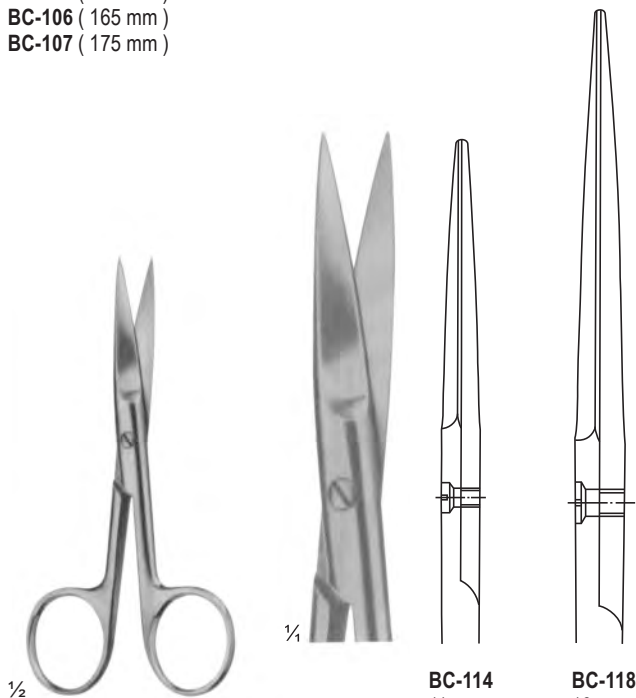

BC-114 - 118
 Standard Types
BC-114 (115 mm)
BC-115 (130 mm)
BC-116 (145 mm)
BC-117 (150 mm)
BC-118 (165 mm)

BC-114
 115 mm

BC-118
 165 mm

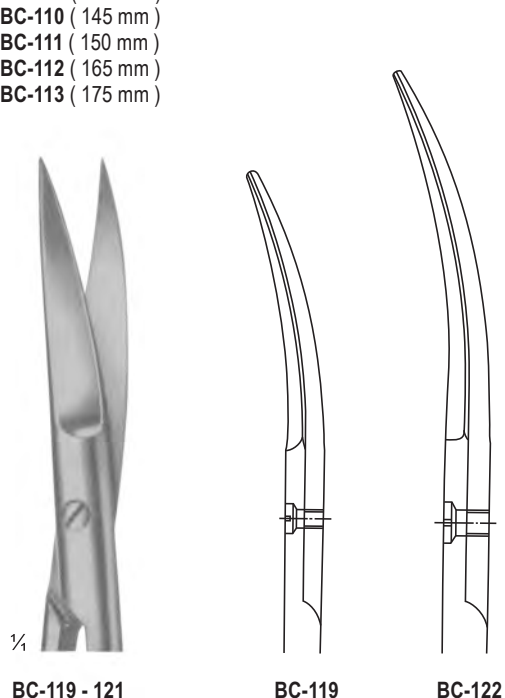

BC-119 - 121
 Standard Types
BC-119 (115 mm)
BC-120 (130 mm)
BC-121 (145 mm)
BC-122 (150 mm)

BC-119
 115 mm

BC-122
 150 mm



BC-123 - 125
DEAVER
With flat lock

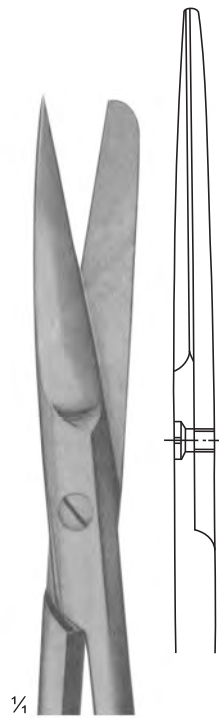

$\frac{1}{4}$
BC-123
145 mm

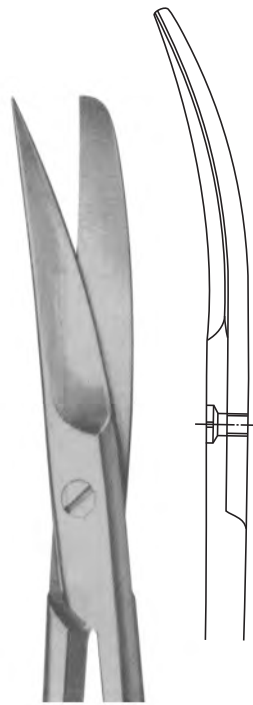

BC-124
145 mm

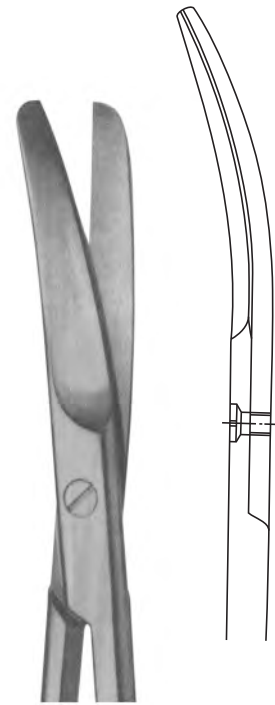

BC-125
145 mm



BC-126 - 128
Incision Scissors

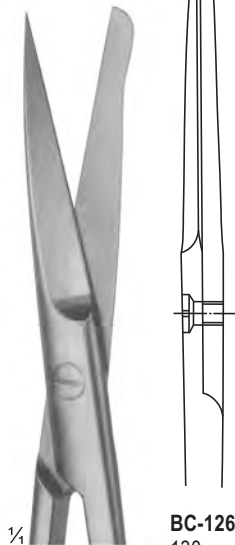

$\frac{1}{4}$
BC-126
130 mm

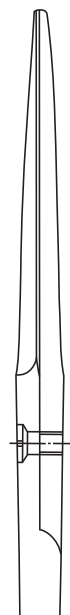

BC-127
145 mm



BC-128
165 mm



BC-129
SYSTRUNK
Nail Splitting Scissors

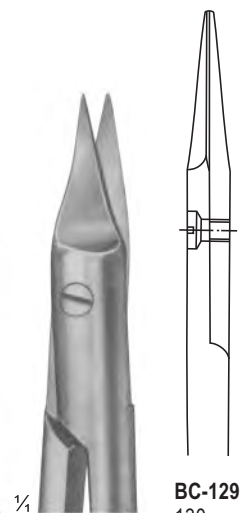

$\frac{1}{4}$
BC-129
130 mm



DISSECTING SCISSORS

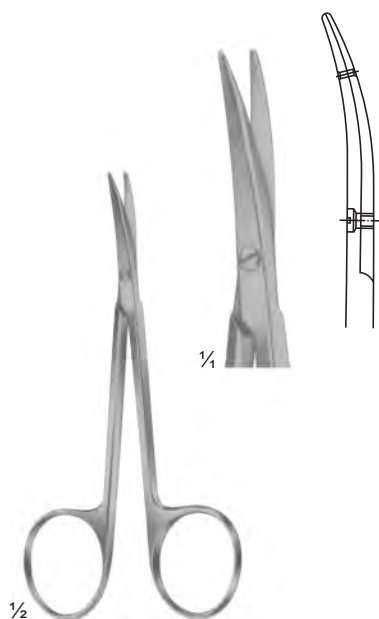

BC-130
LITTLER
Dissecting Scissors
Tips with eye for suture
115 mm

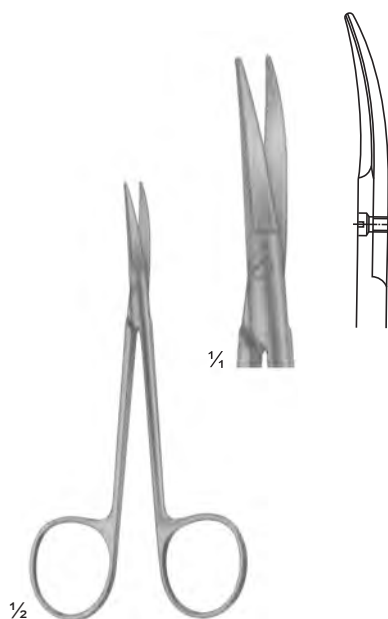

BC-131
COTTLE
Bulldog Scissors
115 mm

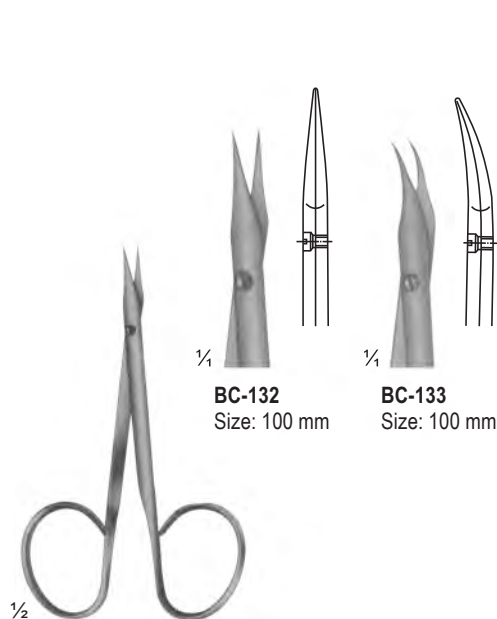

BC-132 - 133
STEVENS
Vessel and tendon Scissors
100 mm

BC-132
Size: 100 mm

BC-133
Size: 100 mm

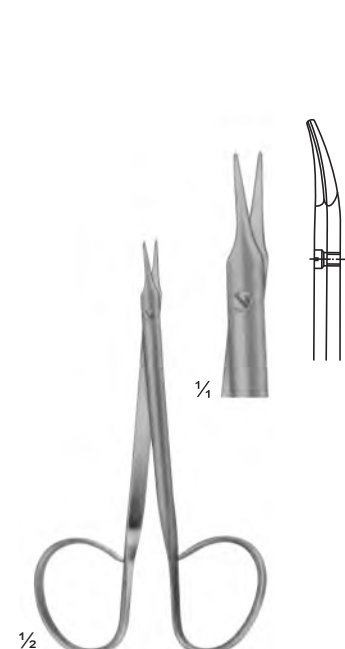

BC-134
STEVENS
Fine Dissecting Scissors
110 mm

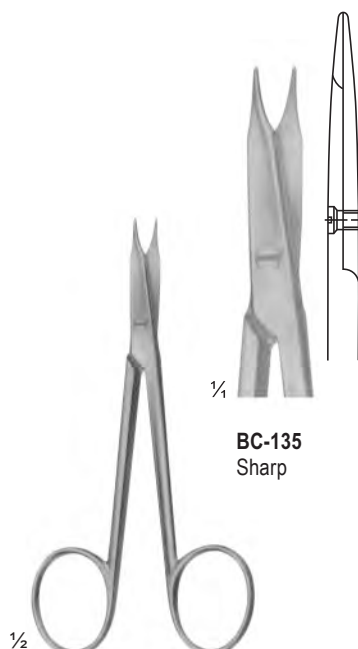

BC-135
Sharp

BC-135 - 138
STEVENS
Vessel and tendon Scissors
110 mm

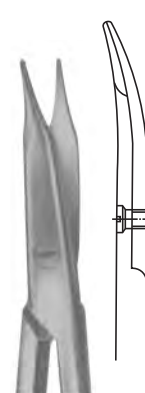

BC-136
Sharp

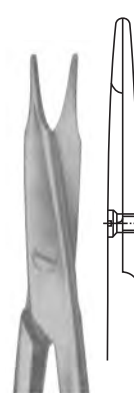

BC-137
Blunt

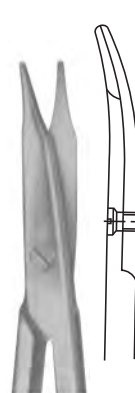

BC-138
Blunt

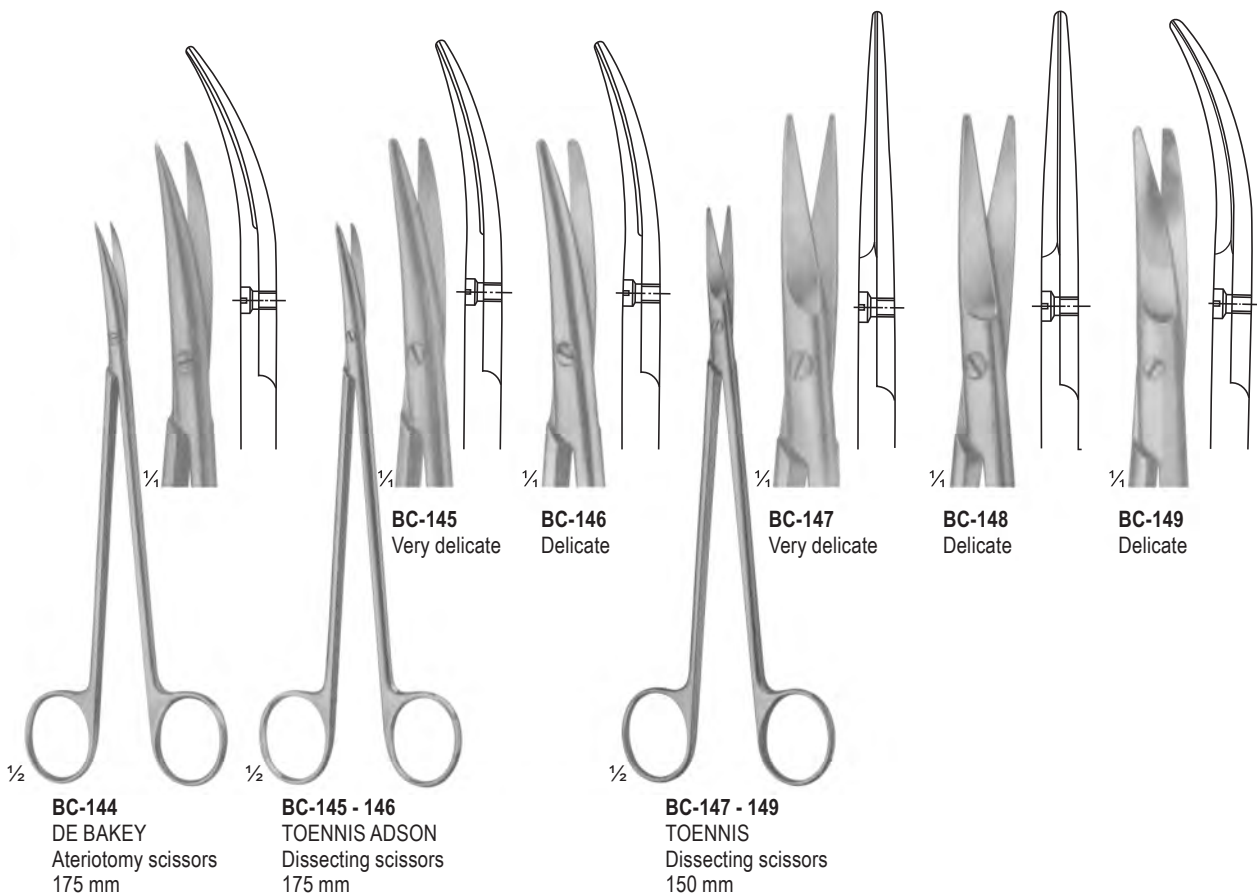
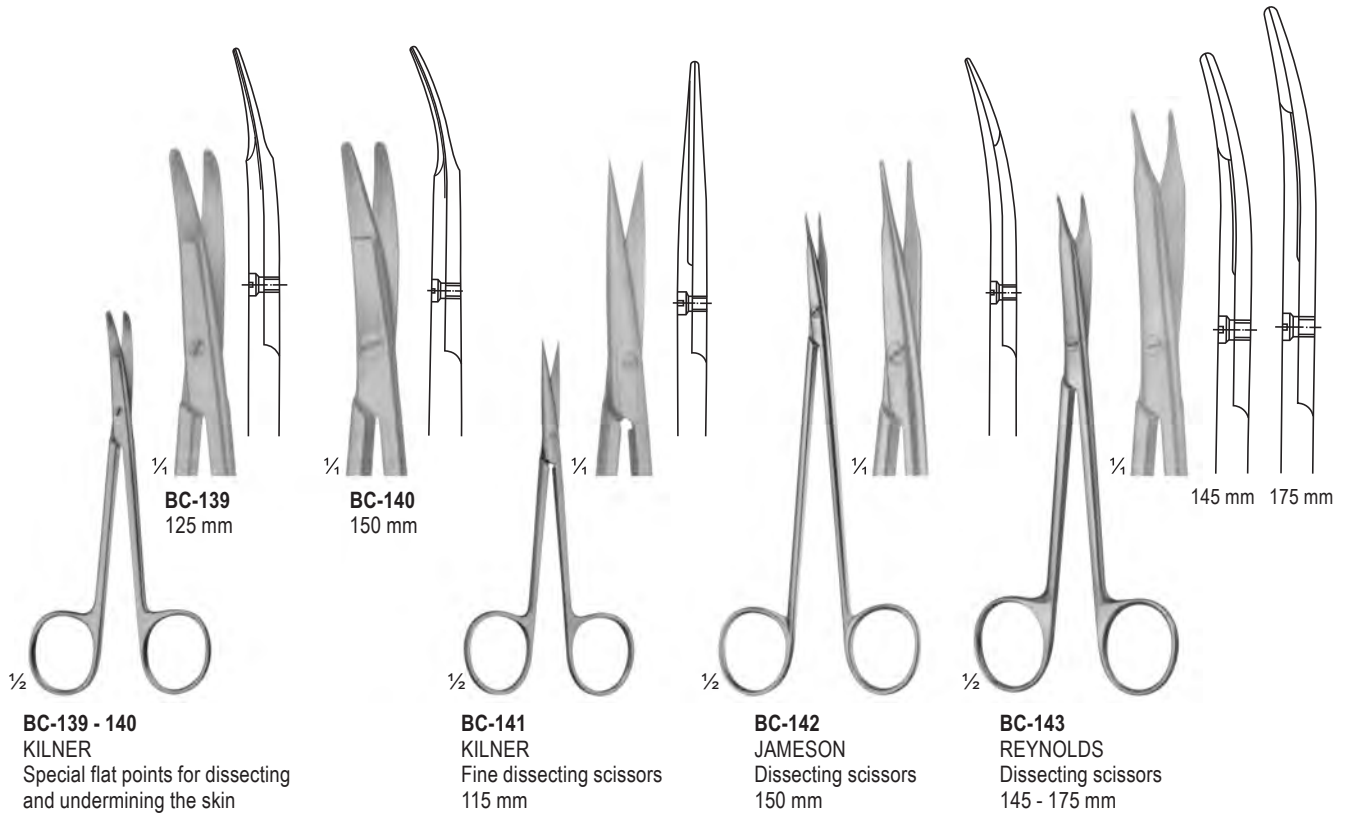

DISSECTING & SURGICAL SCISSORS

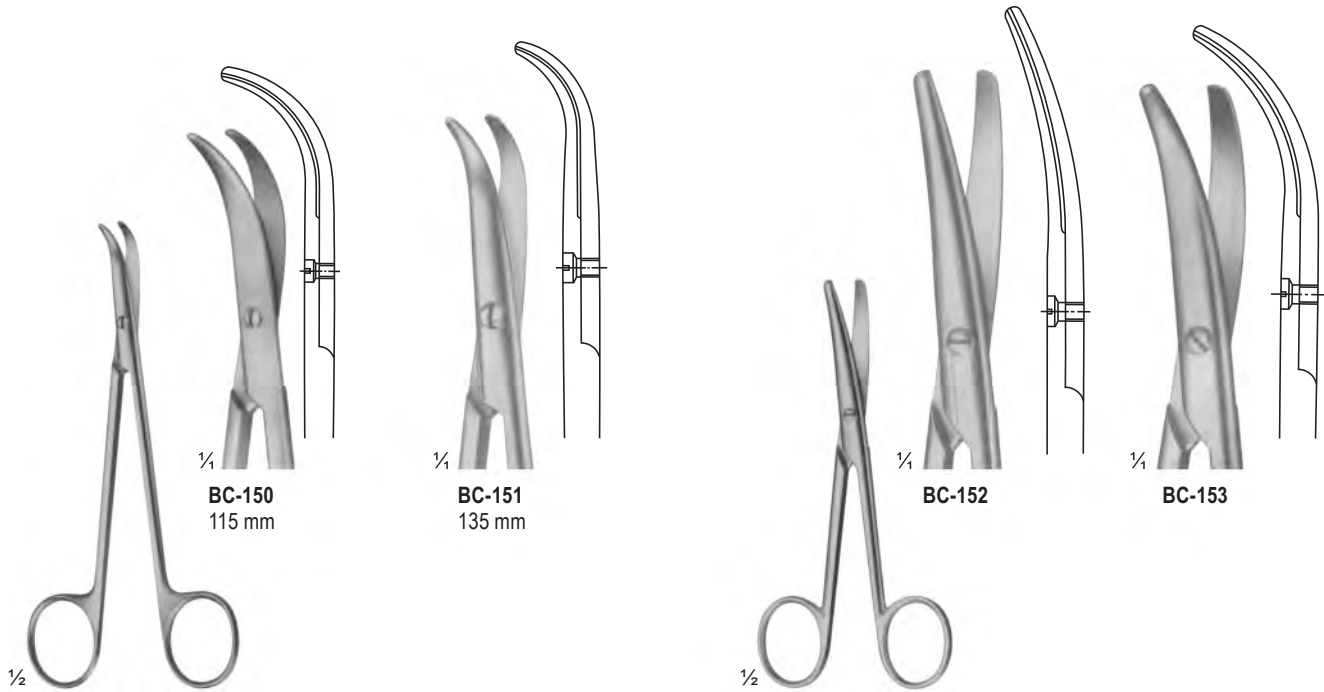

BC-150
115 mm

BC-151
135 mm

BC-152

BC-153

$\frac{1}{2}$
BC-150 - 151
FOMON
Lower lateral scissors

$\frac{1}{2}$
BC-152 - 153
LANDOLT
Enucleation scissors
120 mm

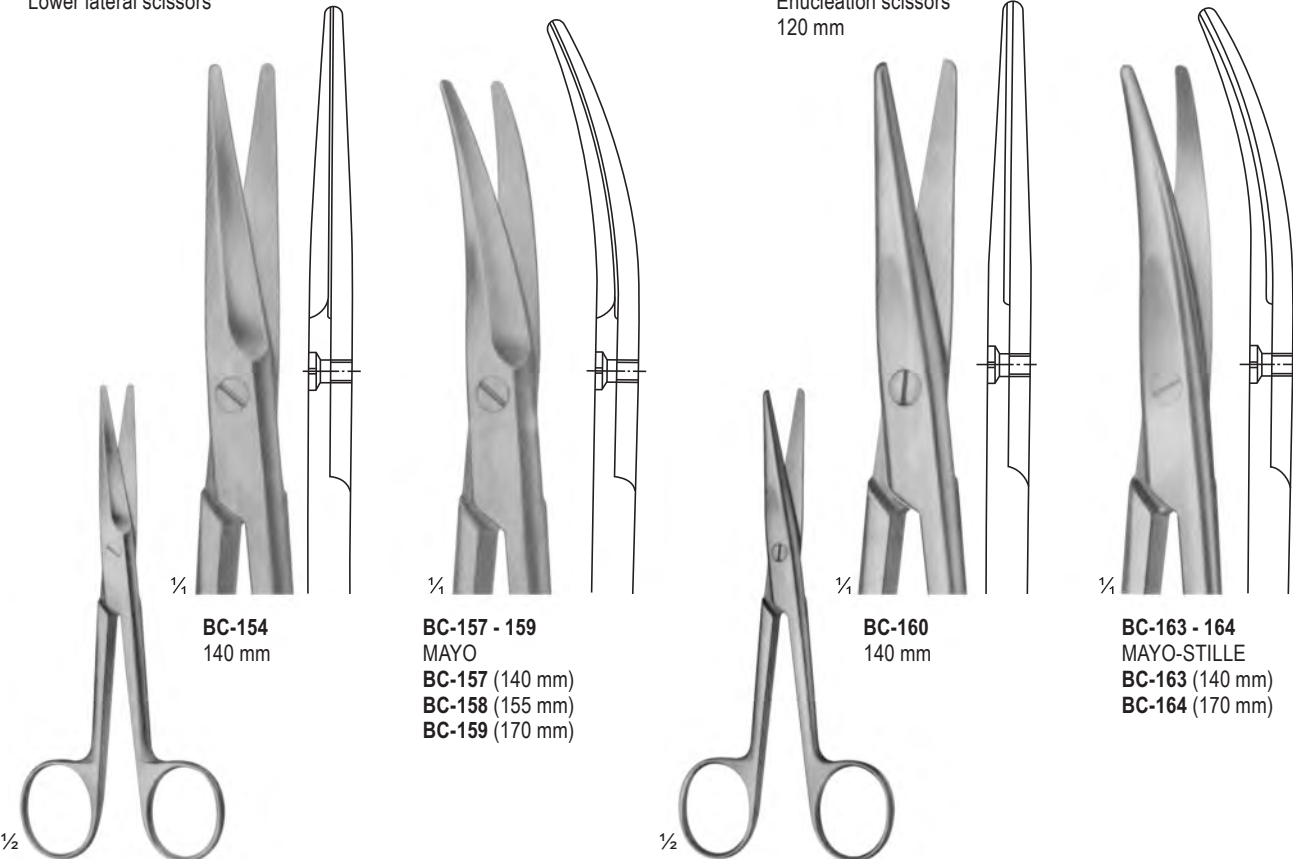

BC-154
140 mm

BC-157 - 159
MAYO
BC-157 (140 mm)
BC-158 (155 mm)
BC-159 (170 mm)

BC-160
140 mm

BC-163 - 164
MAYO-STILLE
BC-163 (140 mm)
BC-164 (170 mm)

$\frac{1}{2}$
BC-154 - 156
MAYO
BC-154 (140 mm)
BC-155 (155 mm)
BC-156 (170 mm)

$\frac{1}{2}$
BC-160 - 162
MAYO-STILLE
BC-161 (140 mm)
BC-162 (170 mm)

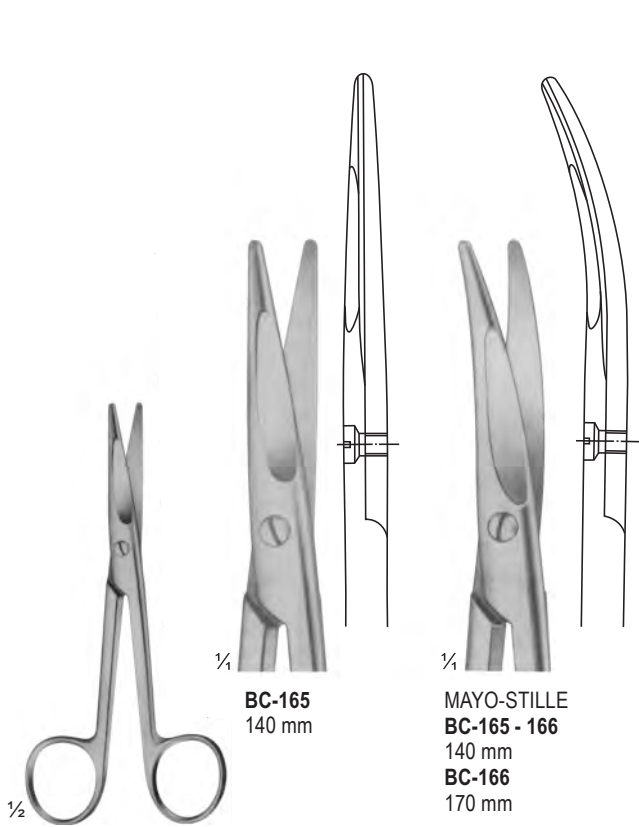

BC-165
140 mm

MAYO-STILLE
BC-165 - 166
140 mm
BC-166
170 mm

BC-165 - 166
MAYO-STILLE
With chamfered blades
BC-165 (140 mm)
BC-166 (170 mm)

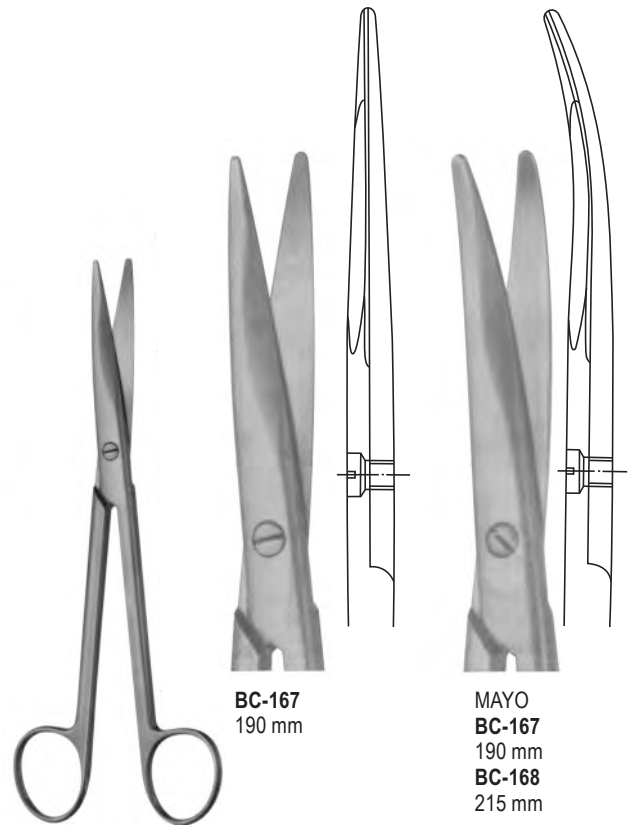

BC-167
190 mm

MAYO
BC-167
190 mm
BC-168
215 mm

MAYO
With chamfered blades
BC-167 (190 mm)
BC-168 (215 mm)

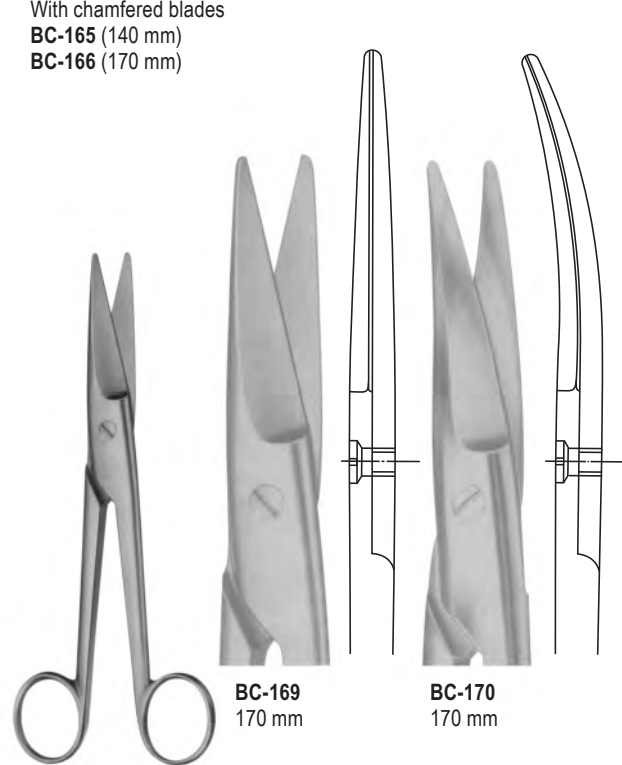

BC-169
170 mm

BC-170
170 mm

BC-169 - 170
MAYO-NOBLE
Broad pattern

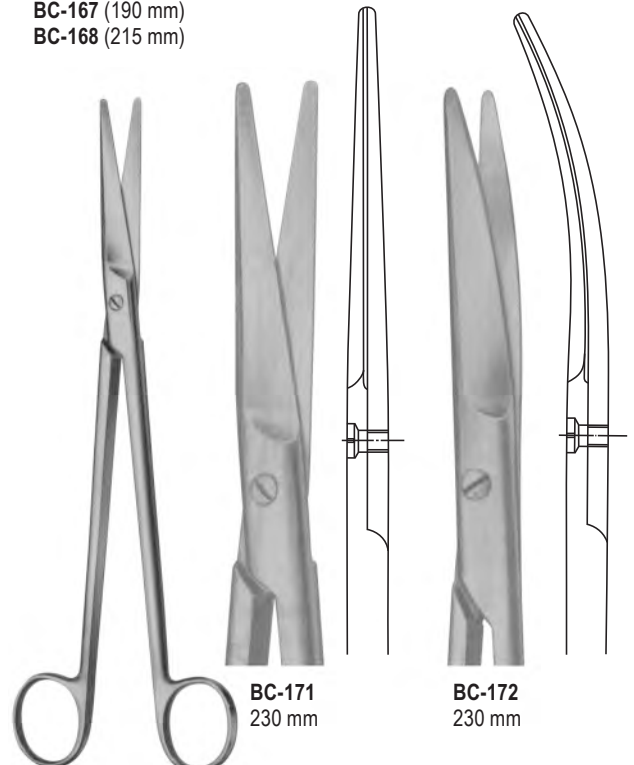

BC-171
230 mm

BC-172
230 mm

BC-171 - 172
MAYO-HARRINGTON

DISSECTING SCISSORS

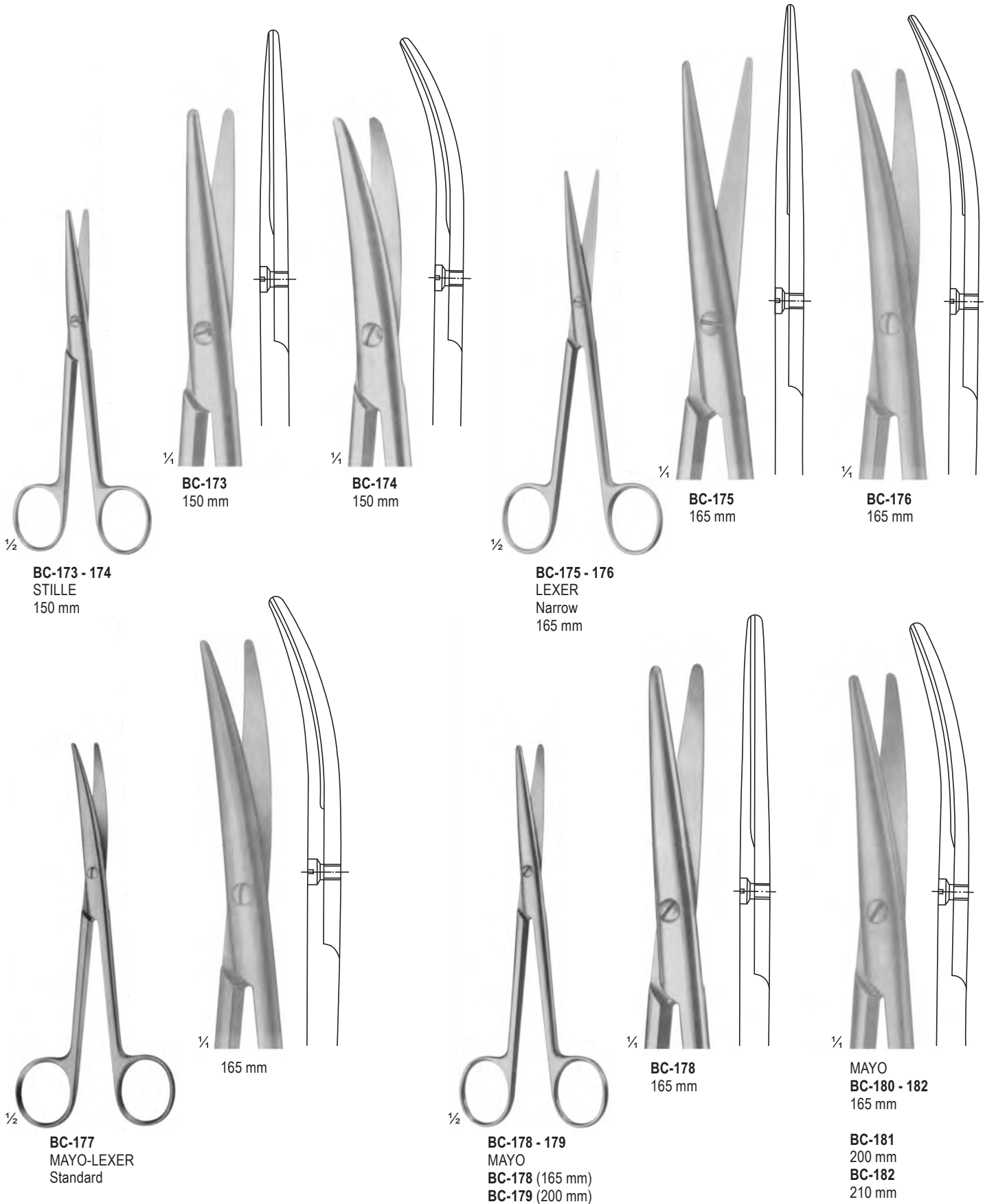

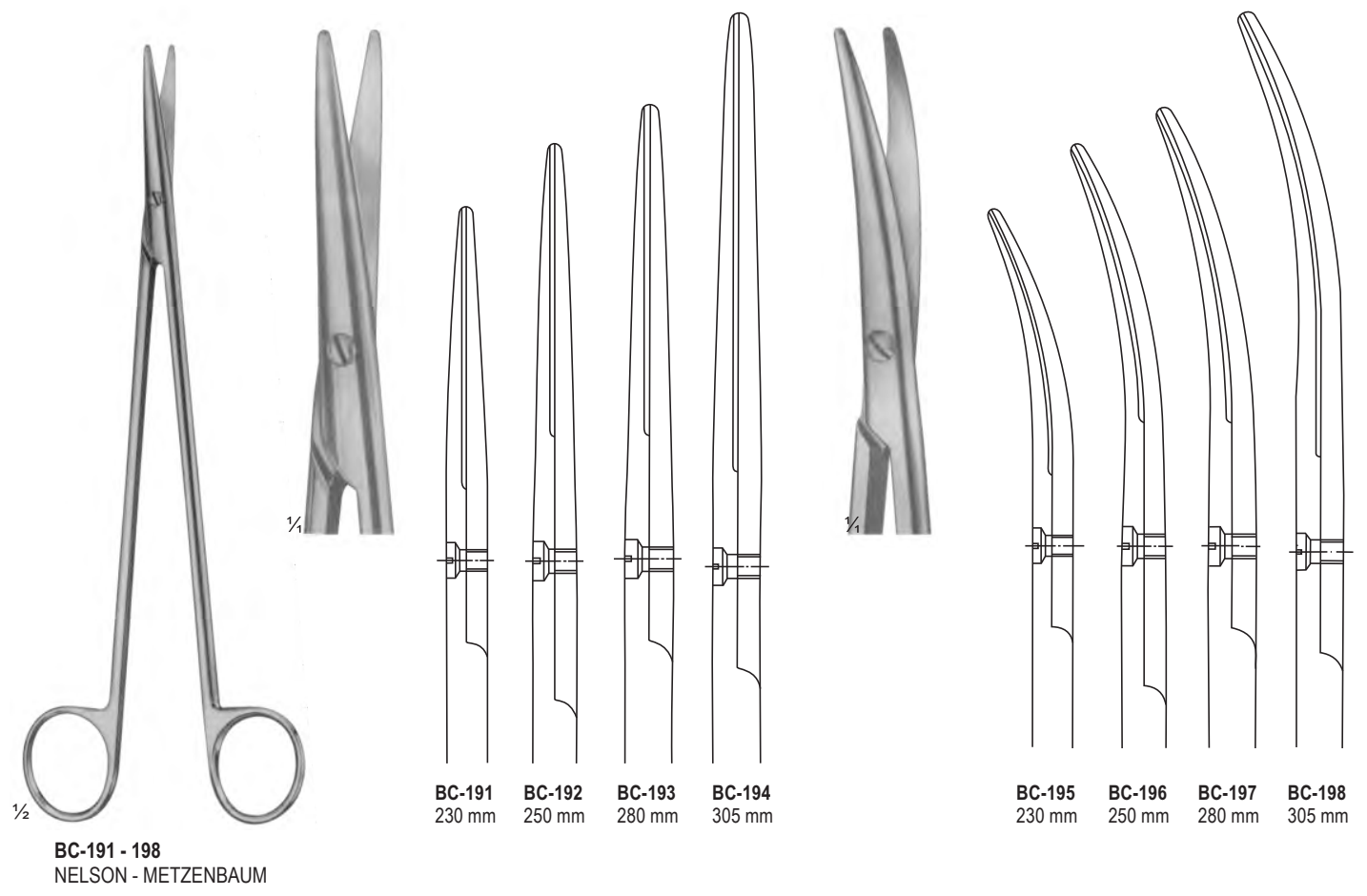
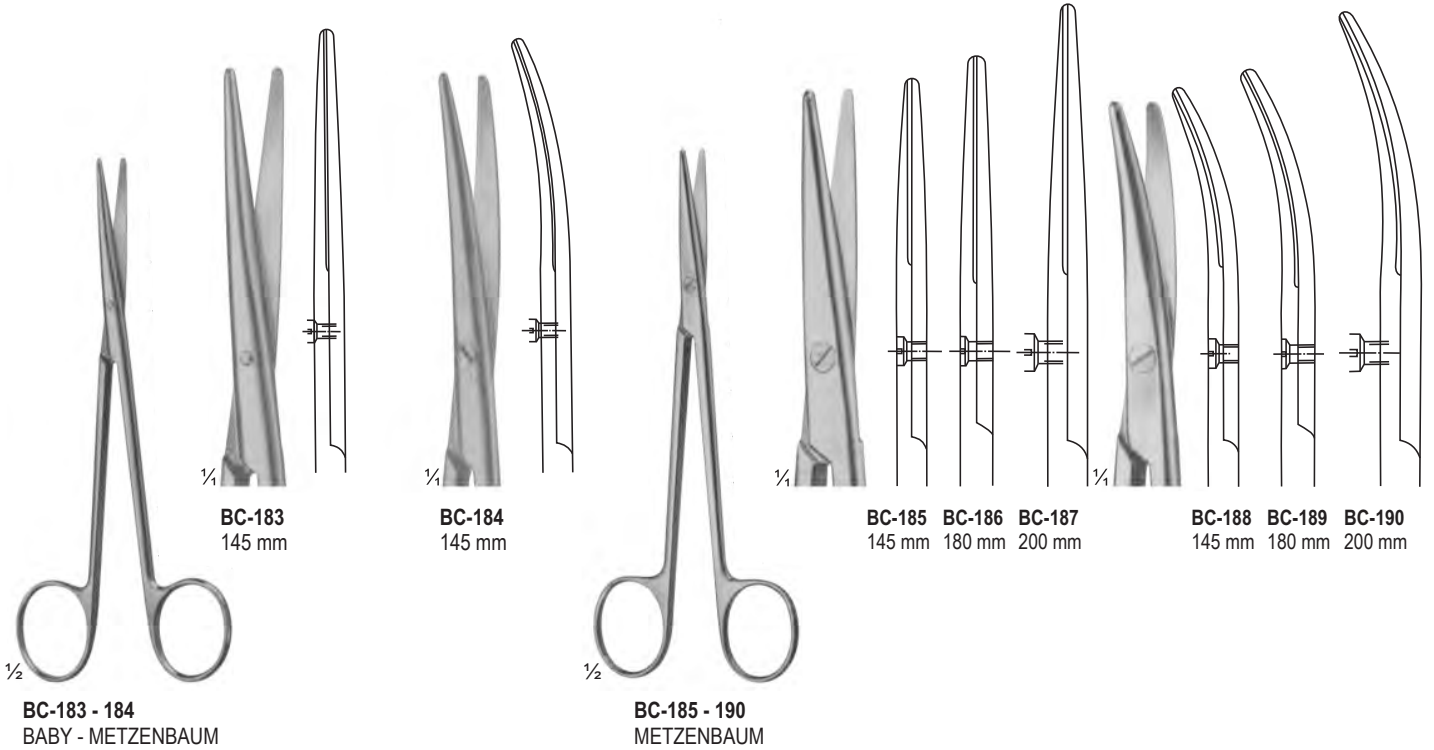



CARDIOVASCULAR AND NEURO-SURGERY SCISSORS

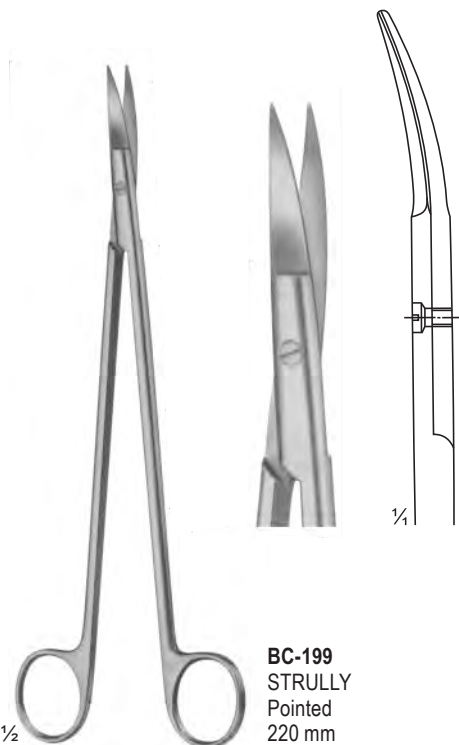

BC-199
STRULLY
Pointed
220 mm

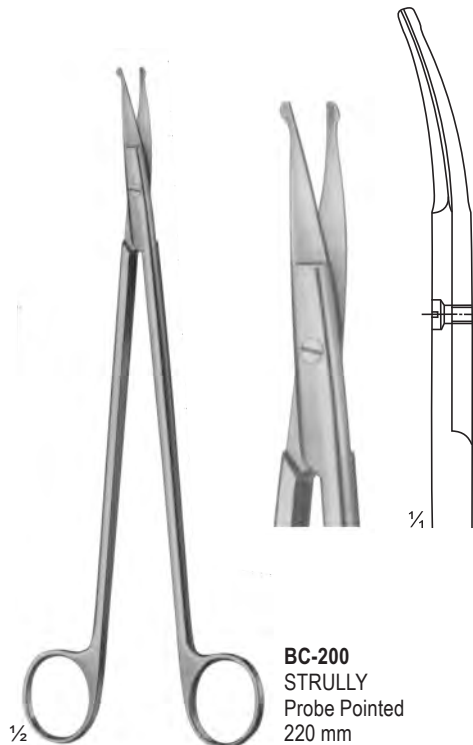

BC-200
STRULLY
Probe Pointed
220 mm

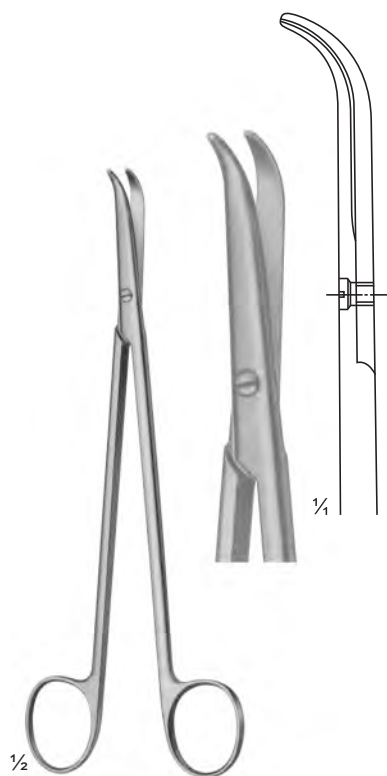

BC-201
THOREK
180 mm

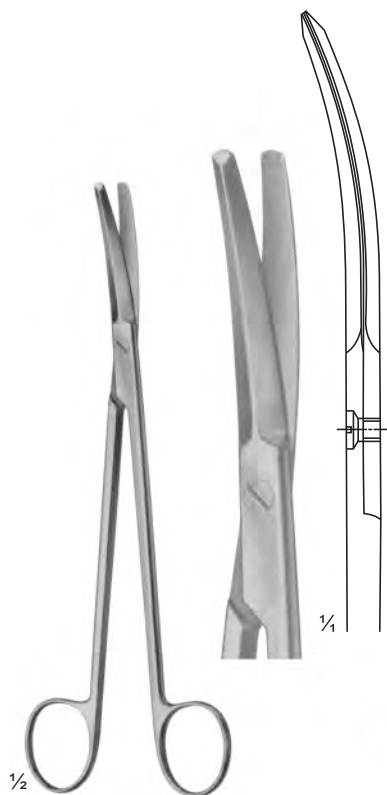

BC-202
POTTS-SMITH
190 mm



BC-203
SATINSKY
245 mm

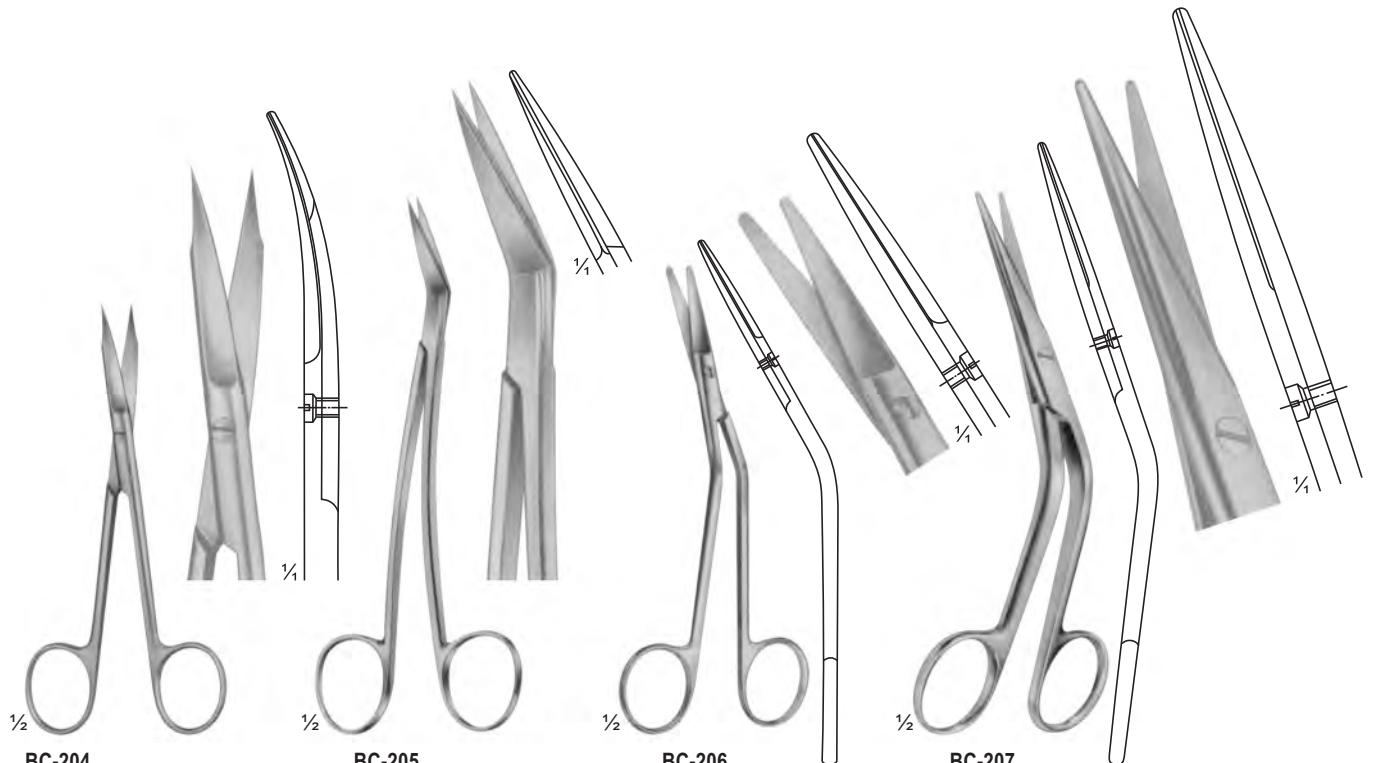

BC-204
Goldman-Fox
1 Finely Toothed Blade
130 mm

BC-205
LOCKLIN
Curved Sideways,
1 Toothed Blade
155 mm

BC-206
FOMON
Blades Serrated
145 mm

BC-207
COTTLE
165 mm

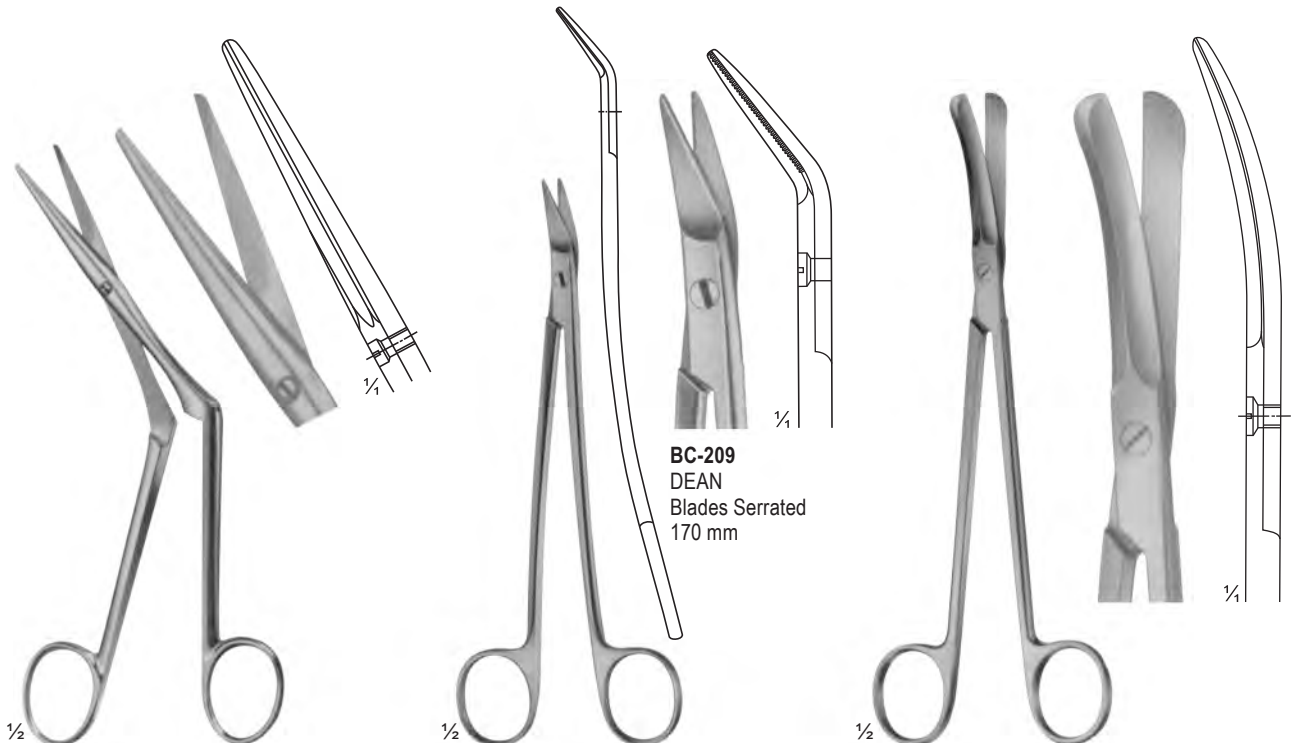

BC-208
HEYMANN-KNIGHT
175 mm

BC-209
DEAN
Blades Serrated
170 mm

BC-210
GOOD
195 mm

OPERATING AND GYNAECOLOGY SCISSORS

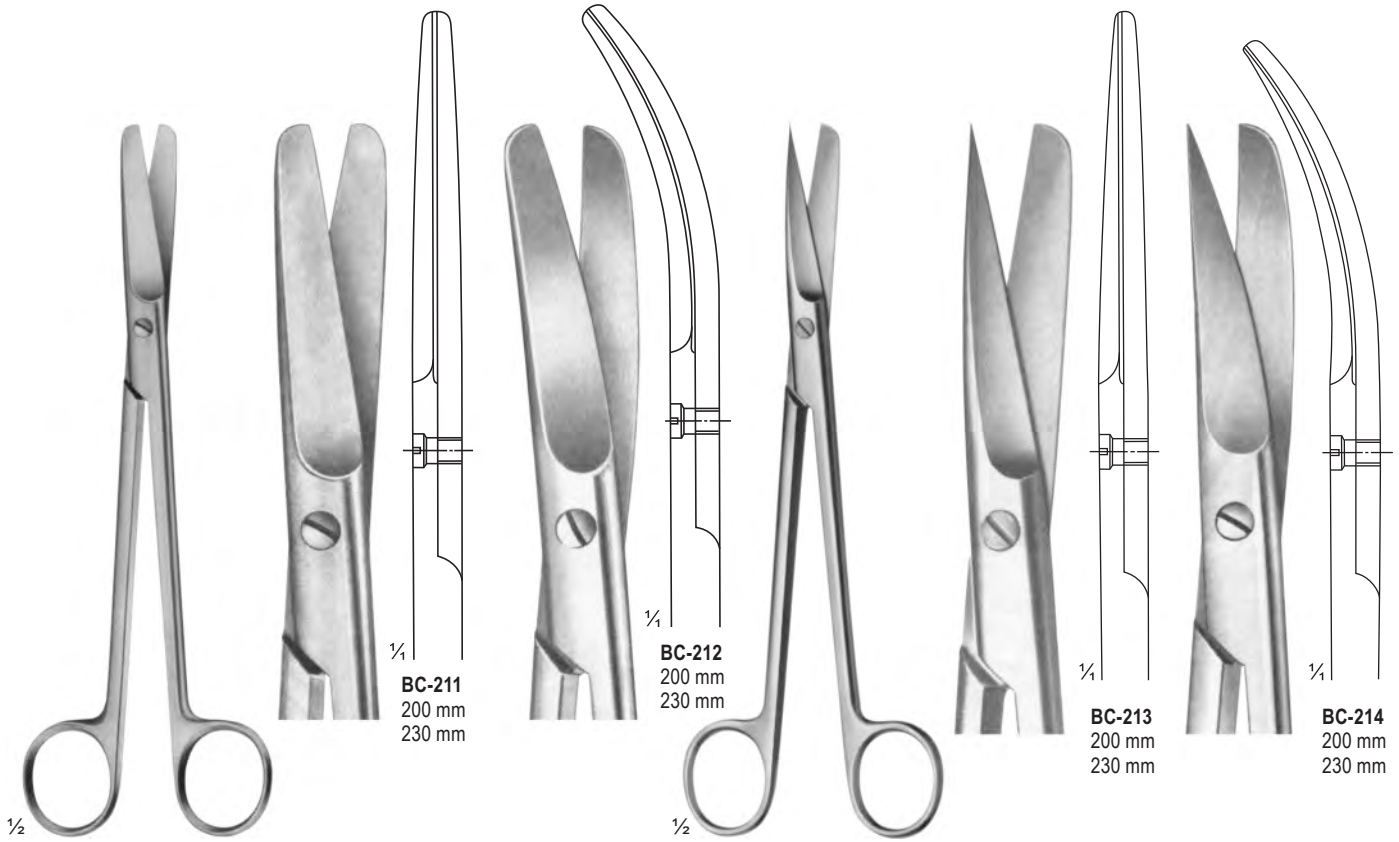

BC-211 - 212
SIMS

BC-213 - 214
SIMS

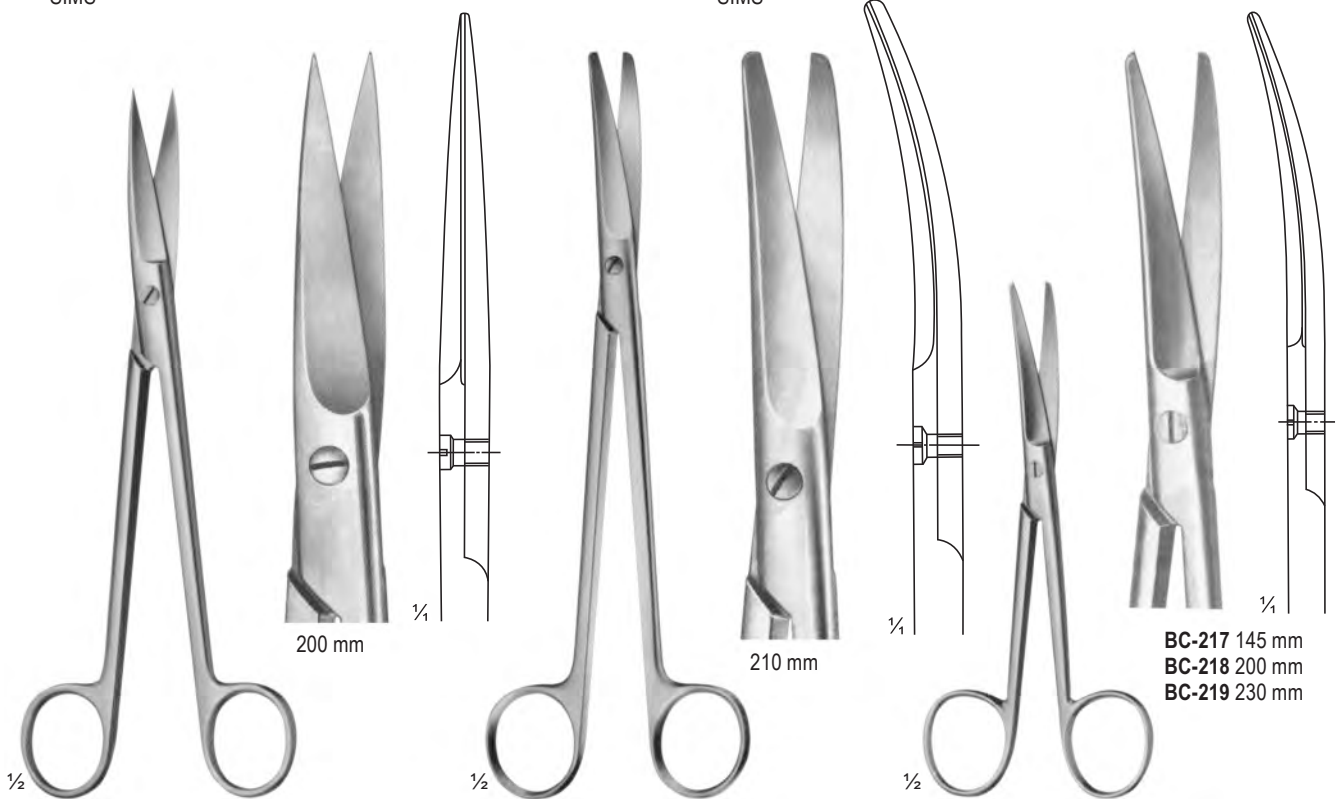

BC-215
SIMS

BC-216
SIMS

BC-217 - 219
WERTHEIM

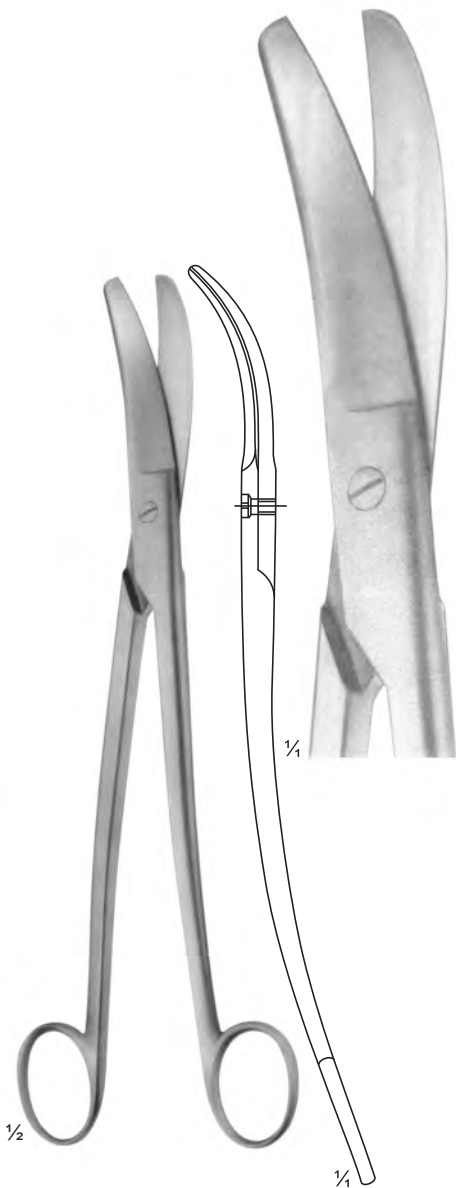

BC-220
SIEBOLD
Uterine Scissors
245 mm

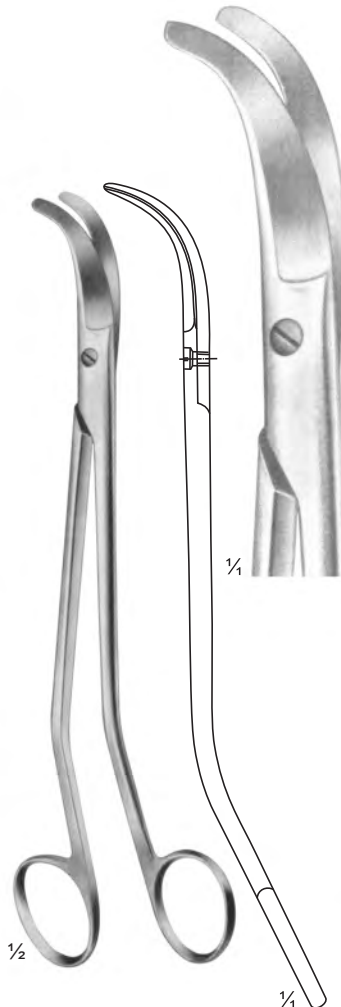

BC-221
BOZEMANN
Uterine Scissors
220 mm

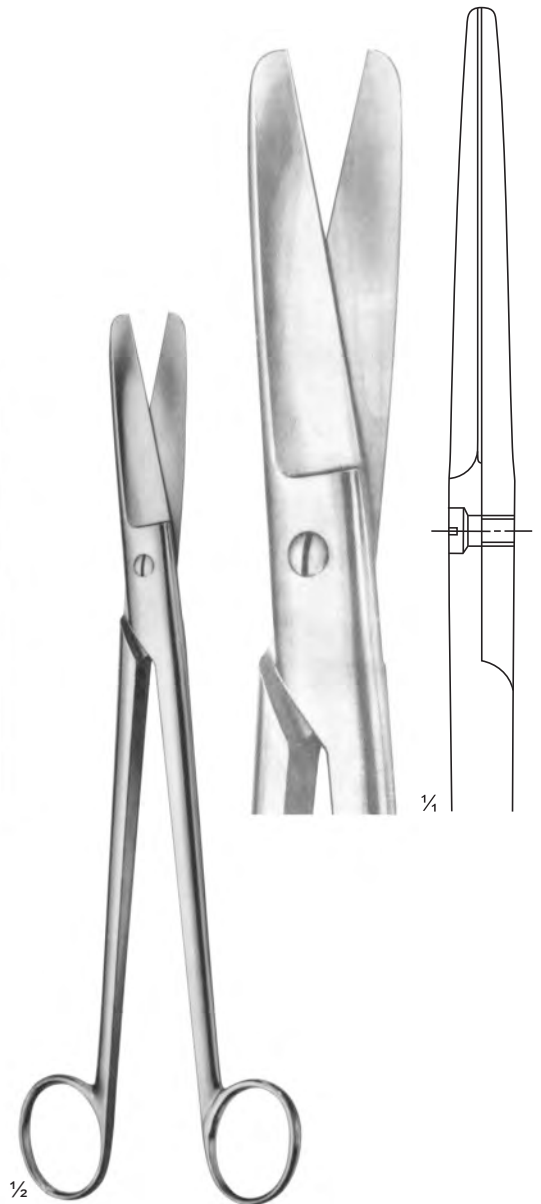

BC-222
SIMS-SIEBOLD
Uterine Scissors
250 mm

OPERATING AND GYNAECOLOGY SCISSORS



BC-223
SCHUMACHER
Umbilical Cord Scissors
155 mm

BC-224
Umbilical Cord Scissors
105 mm

BC-225
Umbilical Cord Scissors
135 mm

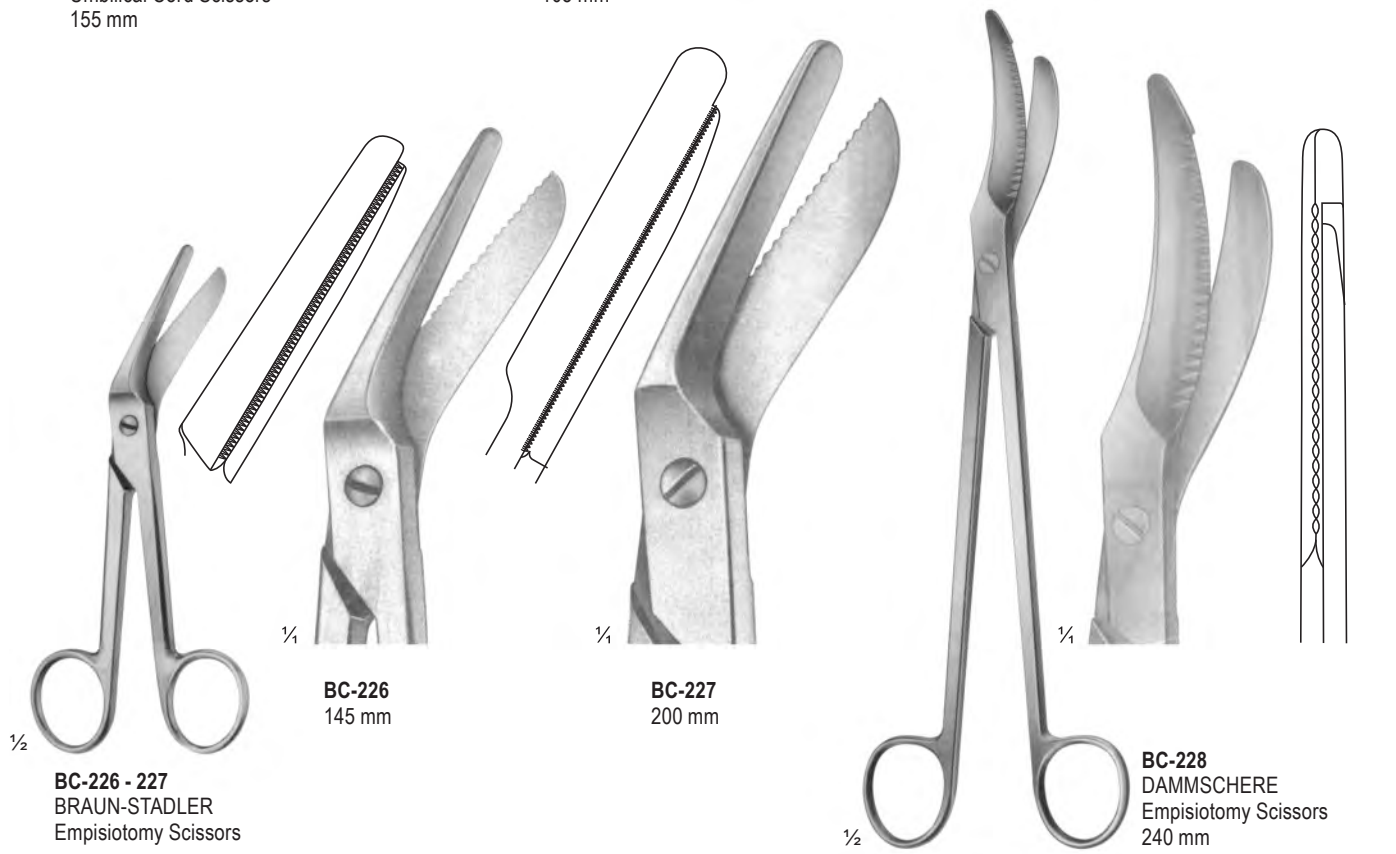

BC-226 - 227
BRAUN-STADLER
Episiotomy Scissors

BC-226
145 mm

BC-227
200 mm

BC-228
DAMMSCHERE
Episiotomy Scissors
240 mm

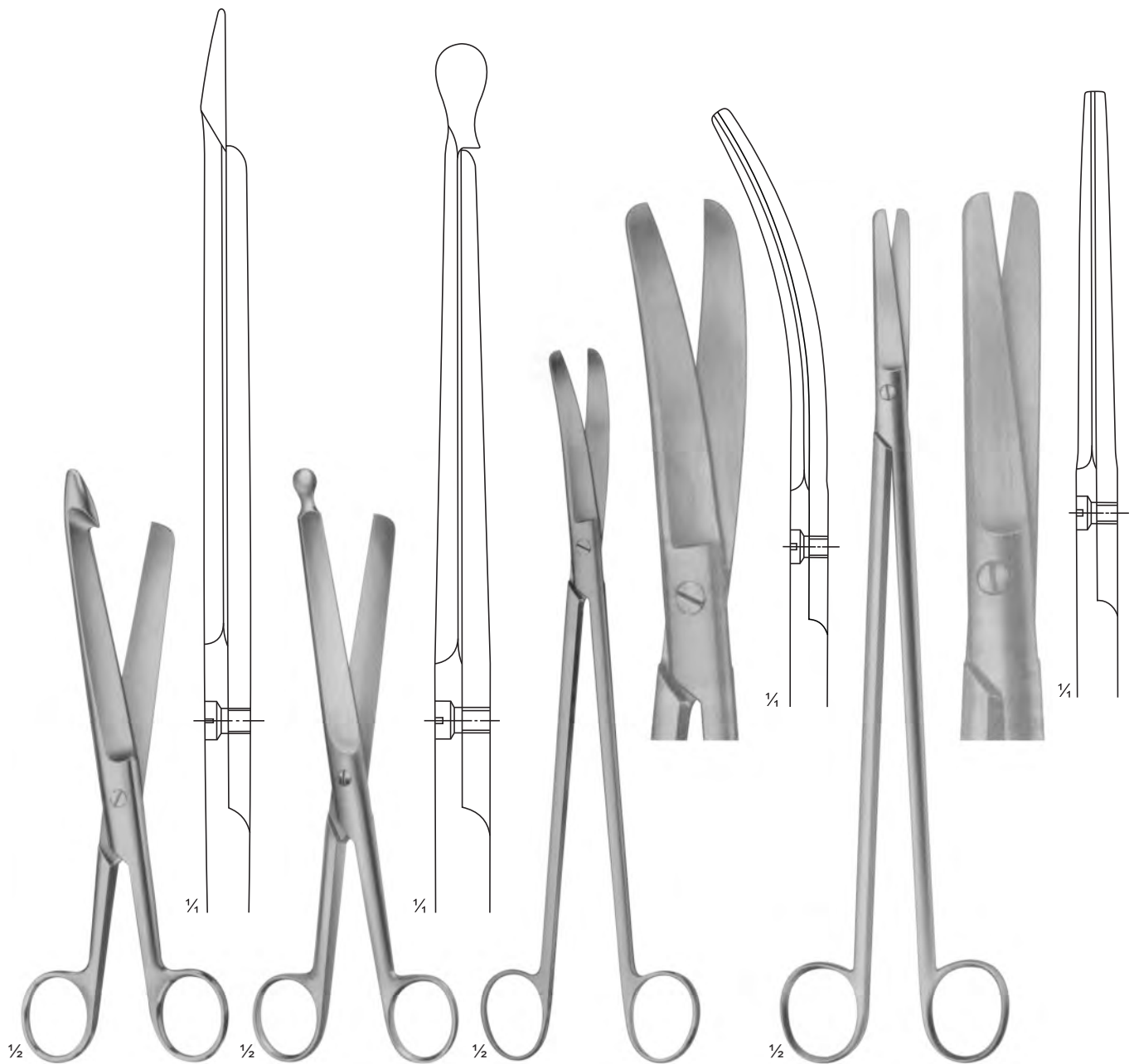

BC-229
DAMMSCHERE
Bowel Scissors
210 mm

BC-230
DAMMSCHERE
Bowel Scissors
210 mm

BC-231
LLOYD-DAVIES
(GOLIGHER'S)
Rectal Scissors
255 mm

BC-232
STELZNER
Rectal Scissors
310 mm



LIGATURE SCISSORS



BC-233
90 mm

BC-234
115 mm

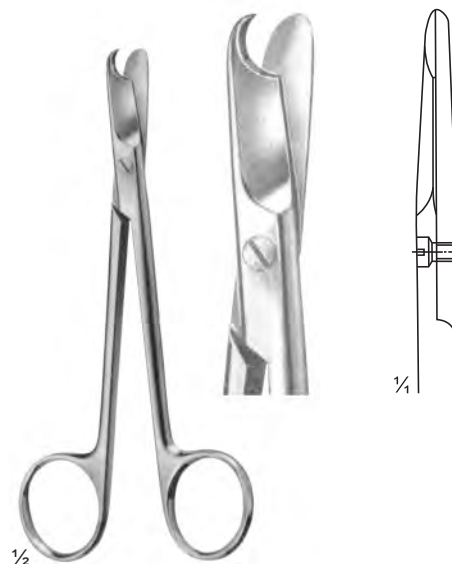

BC-235
LITTAUER
135 mm

BC-235-1
140 mm

BC-235-2
150 mm

BC-233 - 234
SPENCER

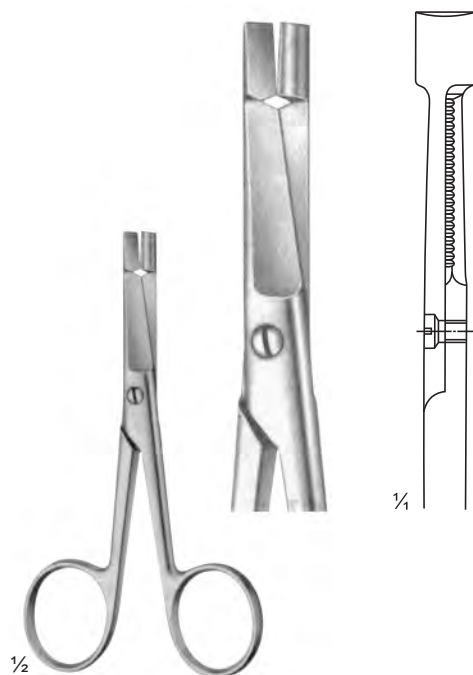

BC-236
EISELSBERG
115 mm

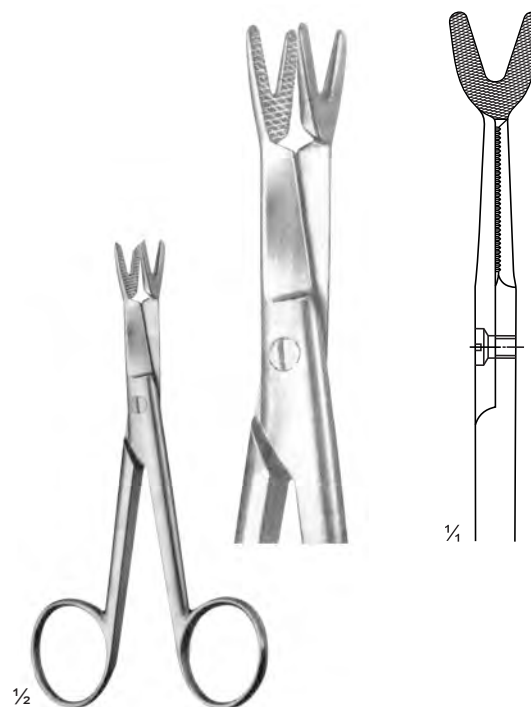

BC-237
SCHOEMAKER-LOTH
125 mm

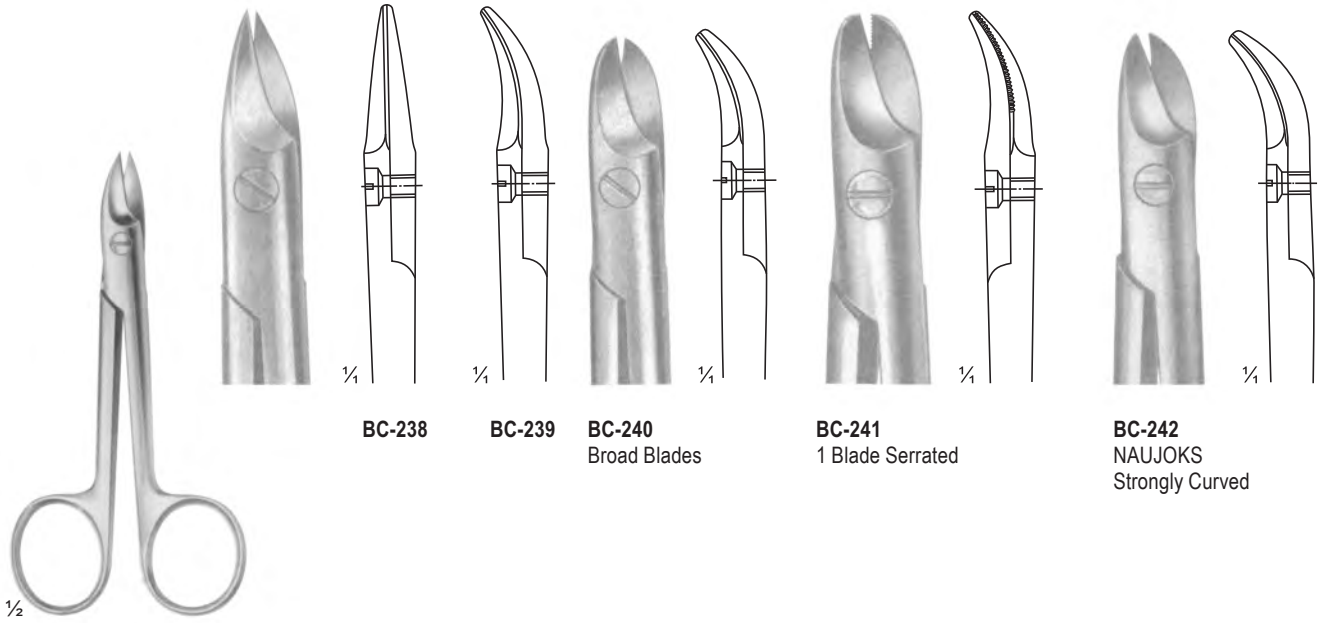

BC-238

BC-239

BC-240
Broad Blades

BC-241
1 Blade Serrated

BC-242
NAUJOKS
Strongly Curved

BC-238 - 242
BEEBE
110 mm

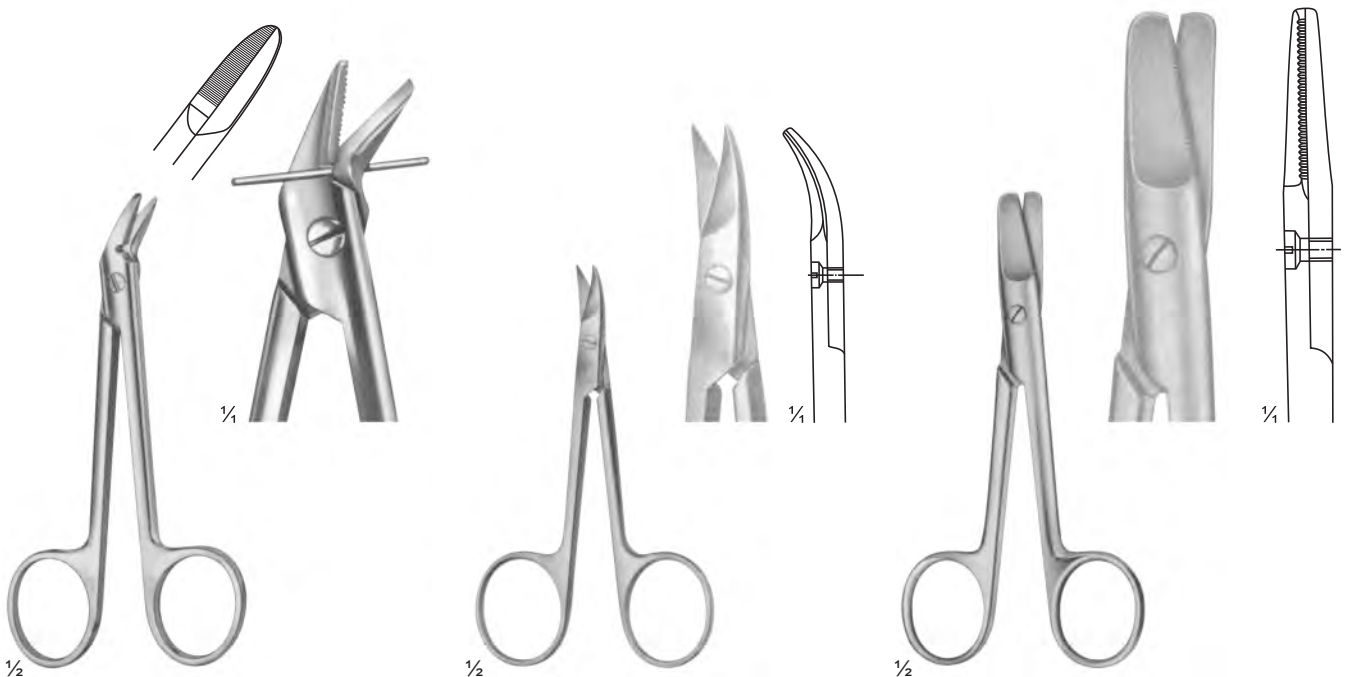

BC-243
1 Blade Serrated
120 mm

BC-244
STRACK
100 mm

BC-245
HARVEY
125 mm

WIRE AND PLATE SCISSORS

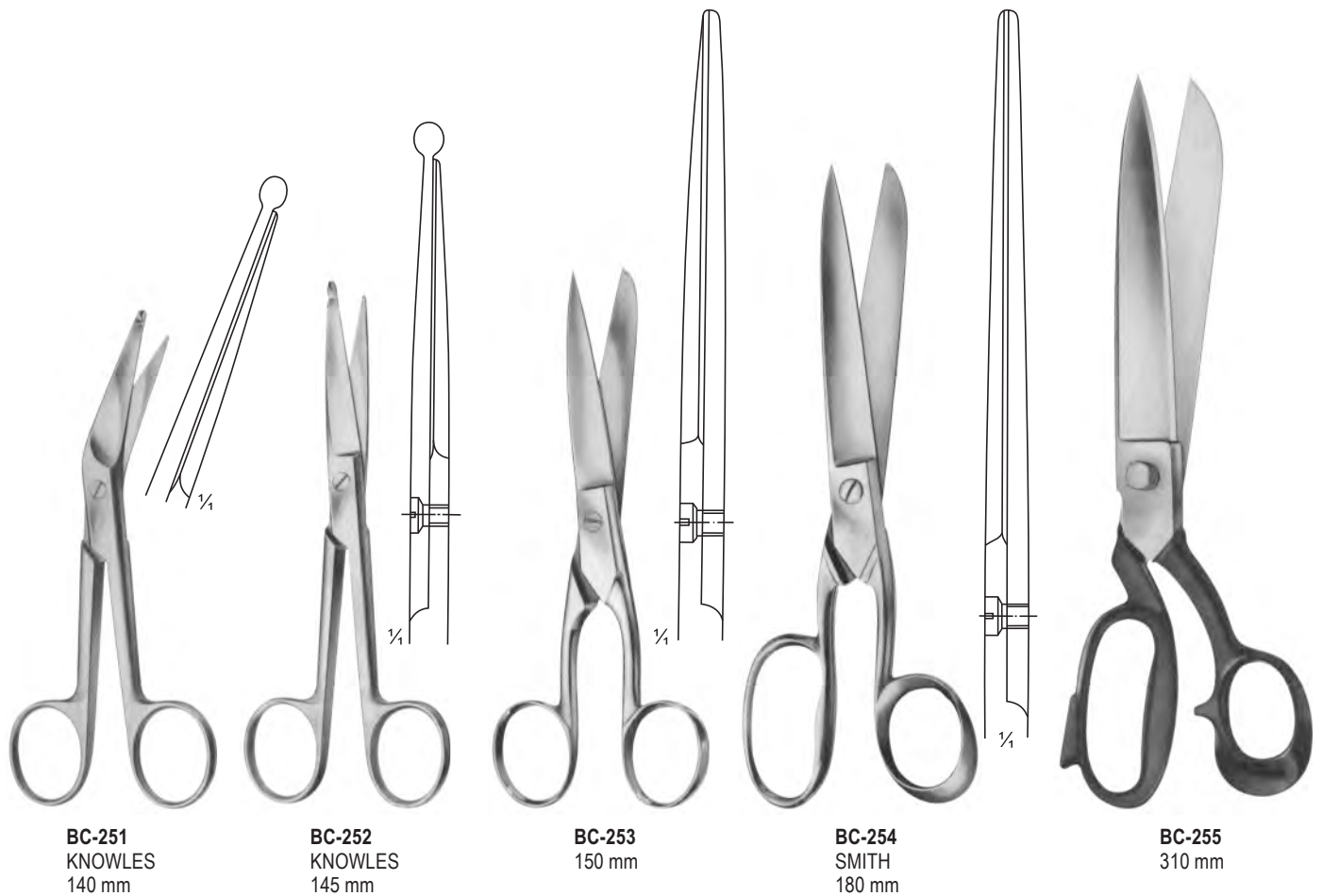
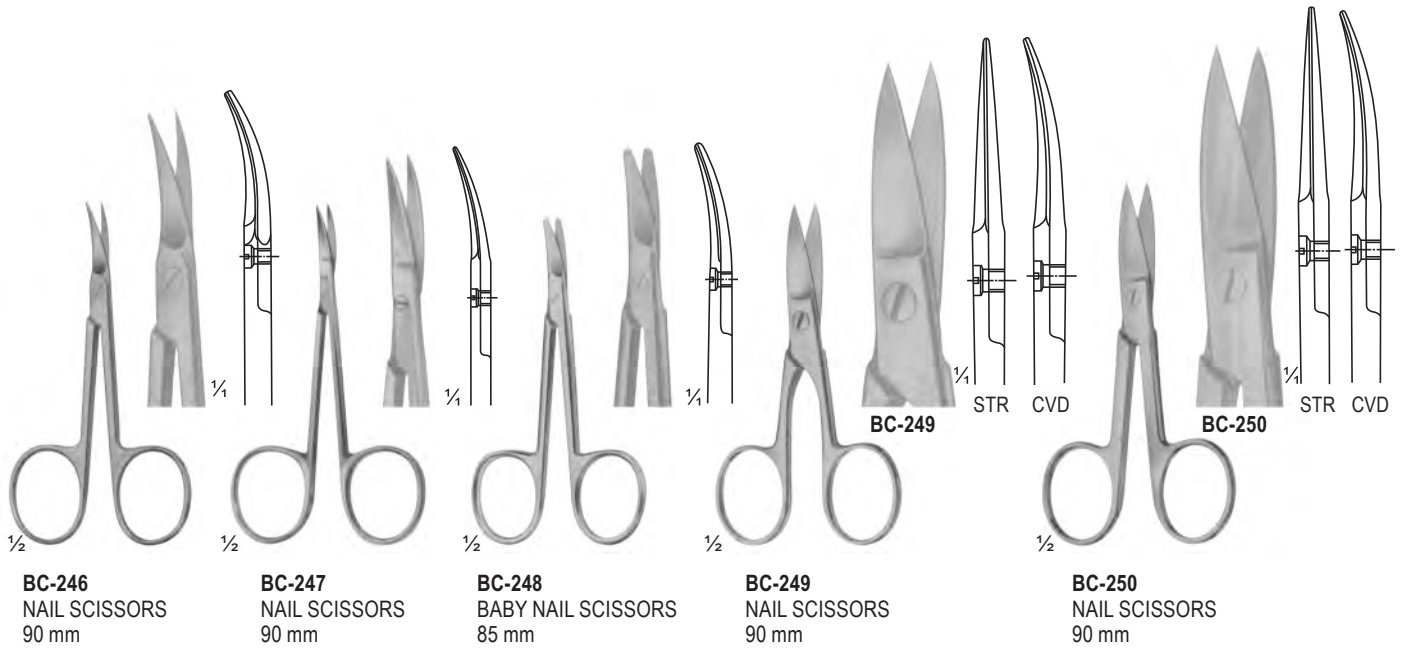



BC-256
UNIVERSAL AND BANDAGE SCISSORS
180 mm

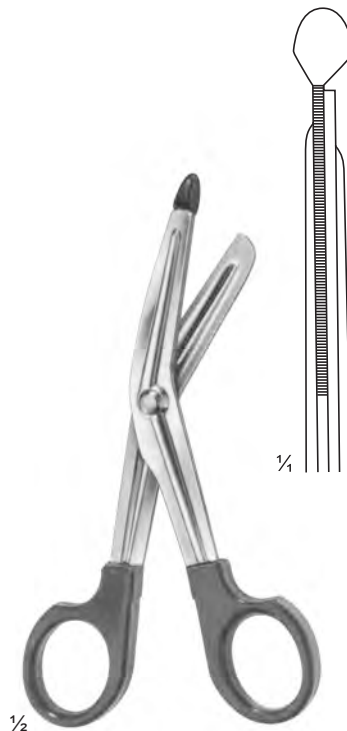
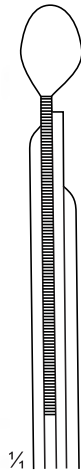

BC-257
LISTER
145 mm

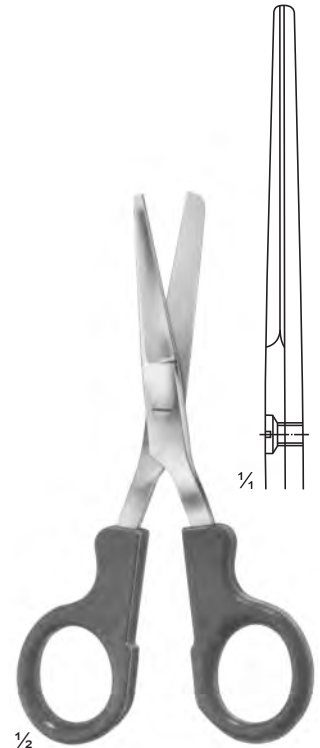
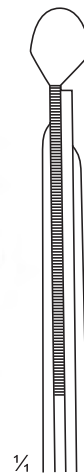

BC-258
LISTER
145 mm

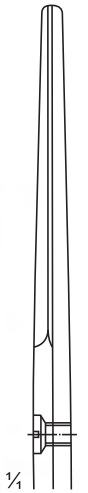

BC-259 - 262
LISTER

BC-259
115 mm

BC-260
140 mm

BC-261
180 mm

BC-262
200 mm
BC-262-1
230 mm

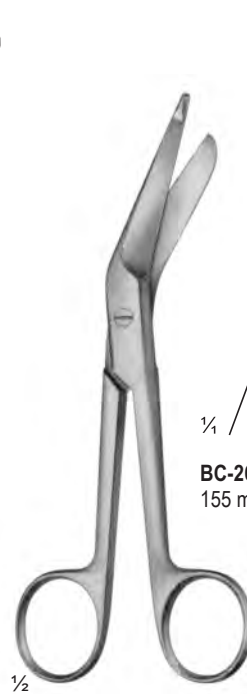

BC-263 - 264
LISTER

BC-263
155 mm

BC-264
180 mm



BANDAGE, CLOTH AND PLASTER SCISSORS



BC-265
CLOTH SCISSORS
205 mm

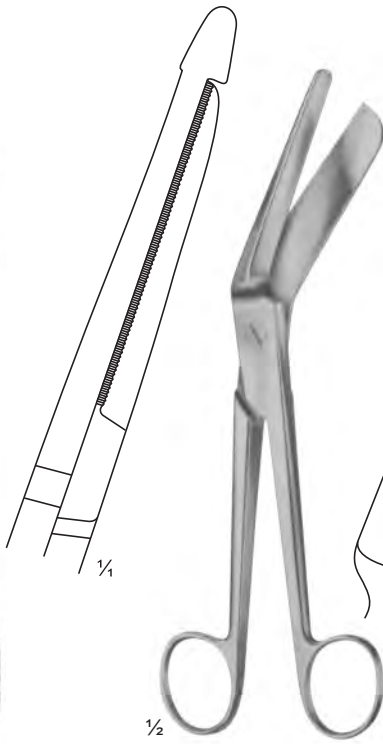

BC-266
BRAUN-STADLER
225 mm



BC-267
SEUTIN
230 mm

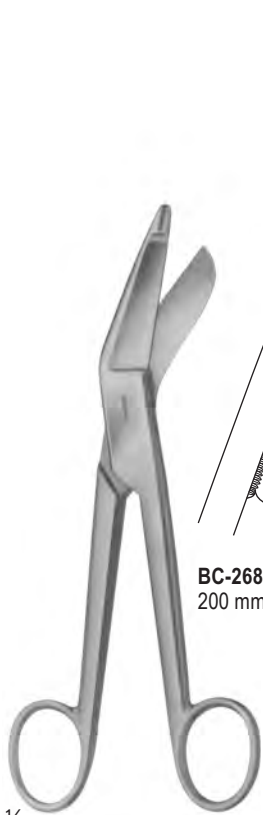
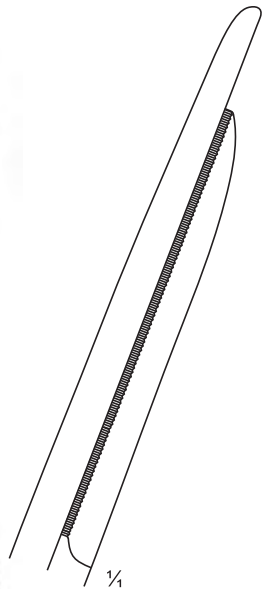

BC-268 - 269
ESMARCH

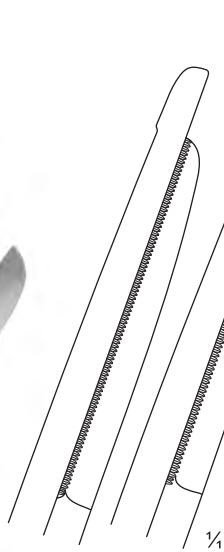

BC-268
200 mm

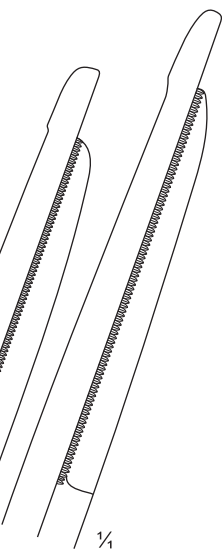

BC-269
230 mm



BC-270
BRUNS
235 mm

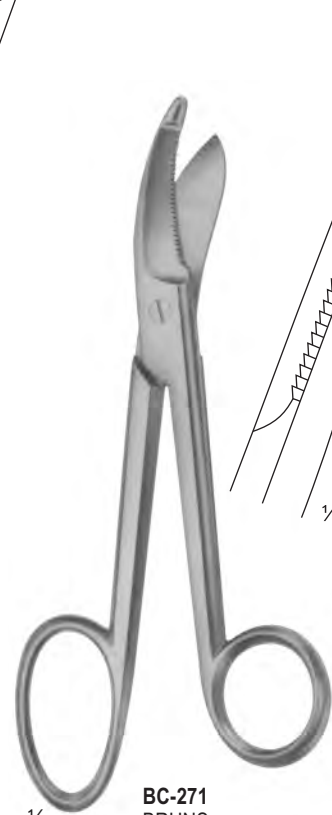
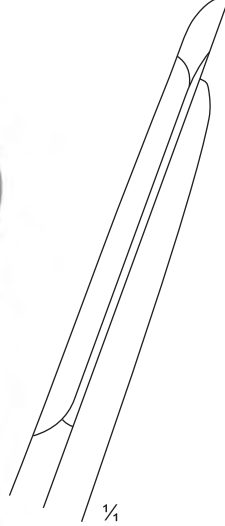

BC-271
BRUNS
235 mm

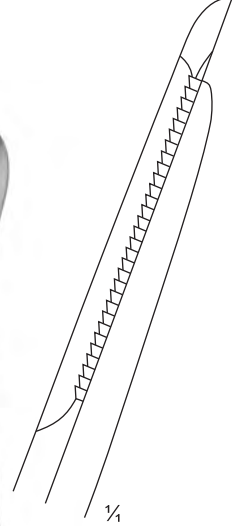



STANDARD
BC-272 14.5 cm, 5 3/4"
BC-273 16.5 cm, 6 1/2"
BC-274 18.5 cm, 7 1/4"



STANDARD
BC-275 14.5 cm, 5 3/4"
BC-276 16.5 cm, 6 1/2"
BC-277 18.5 cm, 7 1/4"



STANDARD
BC-278 14.5 cm, 5 3/4"
BC-279 16.5 cm, 6 1/2"
BC-280 18.5 cm, 7 1/4"



STANDARD
BC-281 14.5 cm, 5 3/4"
BC-282 16.5 cm, 6 1/2"
BC-283 18.5 cm, 7 1/4"



STANDARD
BC-284 14.5 cm, 5 3/4"
BC-285 16.5 cm, 6 1/2"
BC-286 18.5 cm, 7 1/4"



STANDARD
BC-287 14.5 cm, 5 3/4"
BC-288 16.5 cm, 6 1/2"
BC-289 18.5 cm, 7 1/4"



SURGICAL SCISSORS WITH TUNGSTEN CARBIDE EDGES



MAYO
BC-290 14.5 cm, 5 3/4"
BC-291 17.0 cm, 6 3/4"
BC-292 23.0 cm, 9"

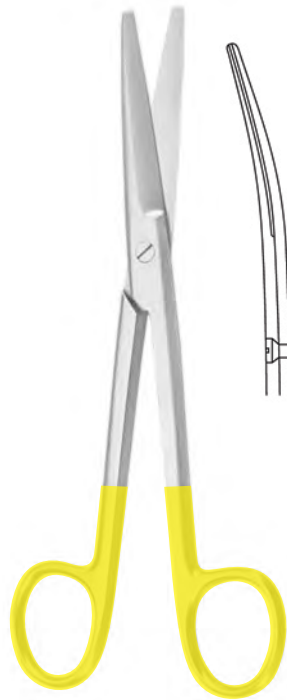

MAYO
BC-293 14.5 cm, 5 3/4"
BC-294 17.0 cm, 6 3/4"
BC-295 23.0 cm, 9"

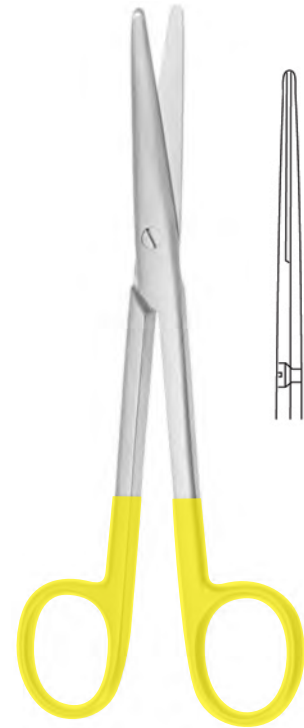

MAYO-STILLE
BC-296 15.0 cm, 6"
BC-297 17.0 cm, 6 3/4"

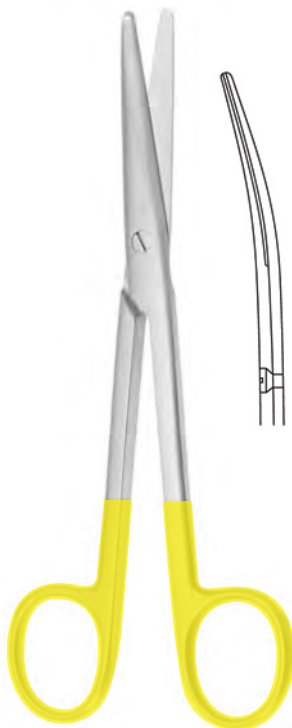

MAYO-STILLE
BC-298 15.0 cm, 6"
BC-299 17.0 cm, 6 3/4"



LEXER
BC-300 16.0 cm, 6 1/4"
BC-301 21.0 cm, 8 1/4"



LEXER
BC-302 16.0 cm, 6 1/4"
BC-303 21.0 cm, 8 1/4"

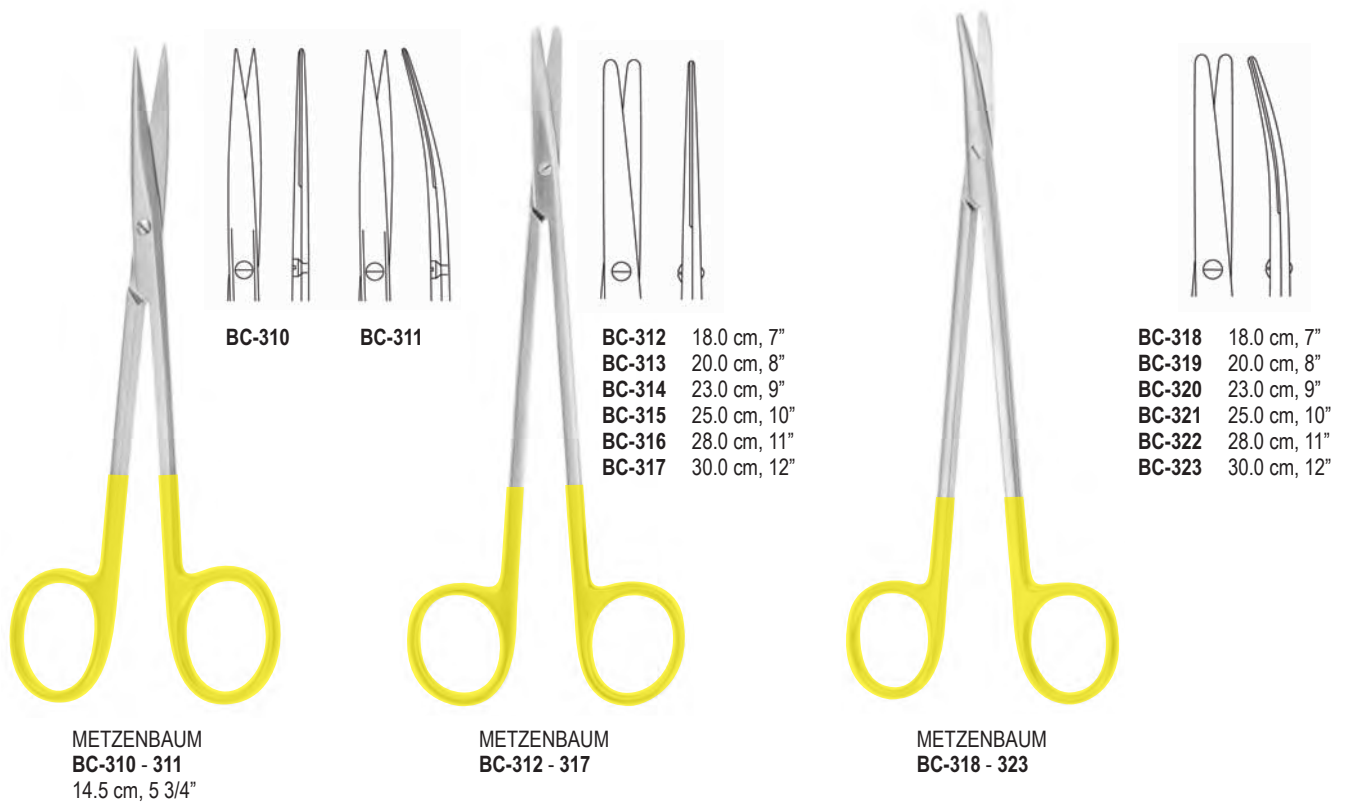
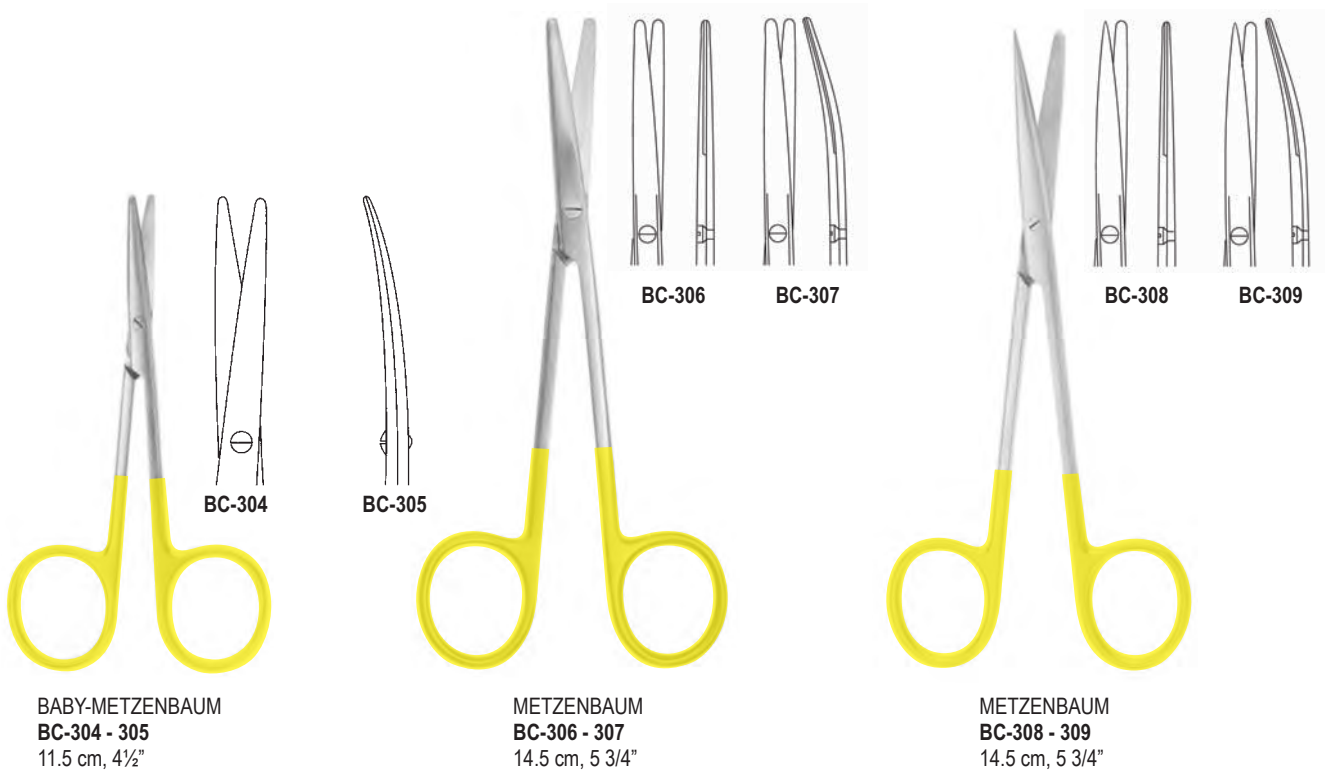

DISSECTING SCISSORS WITH TUNGSTEN CARBIDE EDGES

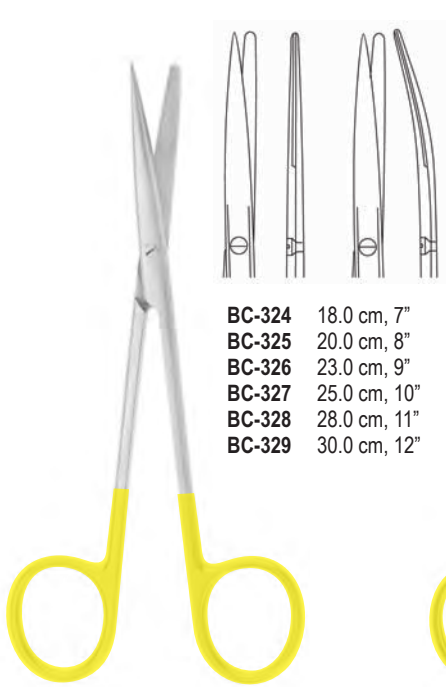

- BC-324** 18.0 cm, 7"
- BC-325** 20.0 cm, 8"
- BC-326** 23.0 cm, 9"
- BC-327** 25.0 cm, 10"
- BC-328** 28.0 cm, 11"
- BC-329** 30.0 cm, 12"

METZENBAUM
BC-324 - 329

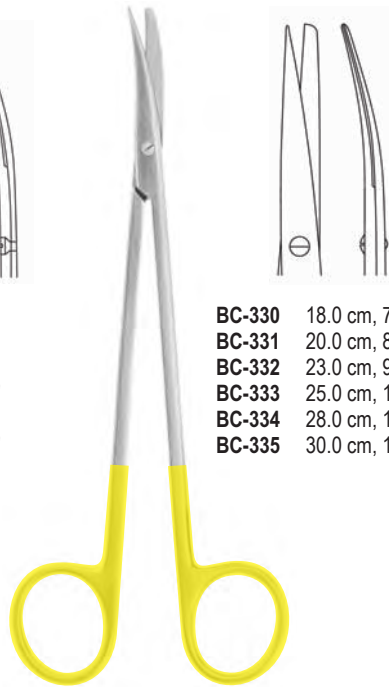

- BC-330** 18.0 cm, 7"
- BC-331** 20.0 cm, 8"
- BC-332** 23.0 cm, 9"
- BC-333** 25.0 cm, 10"
- BC-334** 28.0 cm, 11"
- BC-335** 30.0 cm, 12"

METZENBAUM
BC-330 - 335

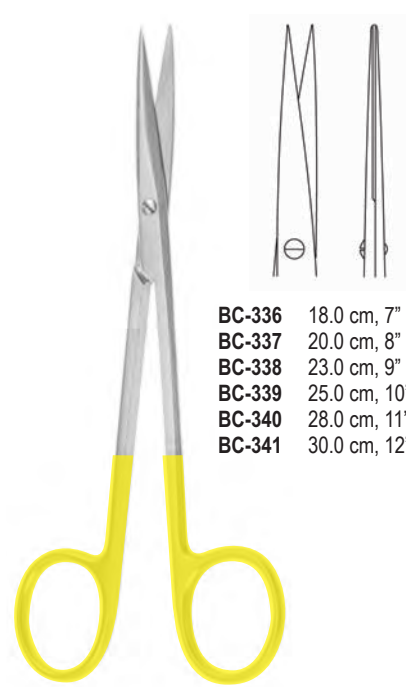

- BC-336** 18.0 cm, 7"
- BC-337** 20.0 cm, 8"
- BC-338** 23.0 cm, 9"
- BC-339** 25.0 cm, 10"
- BC-340** 28.0 cm, 11"
- BC-341** 30.0 cm, 12"

METZENBAUM
BC-336 - 341

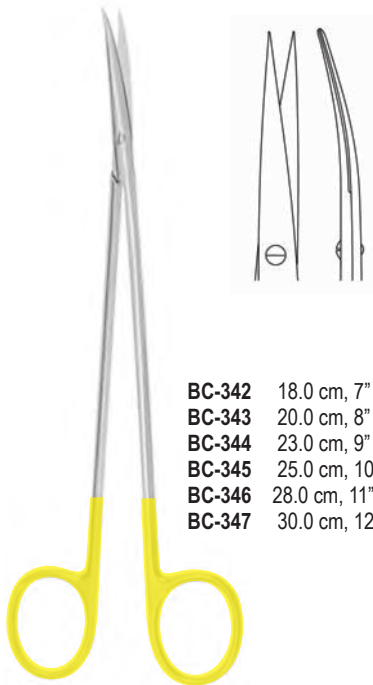

- BC-342** 18.0 cm, 7"
- BC-343** 20.0 cm, 8"
- BC-344** 23.0 cm, 9"
- BC-345** 25.0 cm, 10"
- BC-346** 28.0 cm, 11"
- BC-347** 30.0 cm, 12"

METZENBAUM
BC-342 - 347

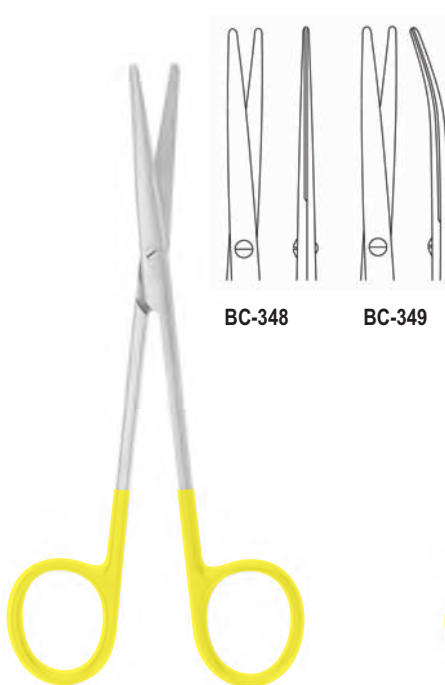

- BC-348**
- BC-349**

METZENBAUM-FINO
BC-348 - 349
14.5 cm, 5 3/4"

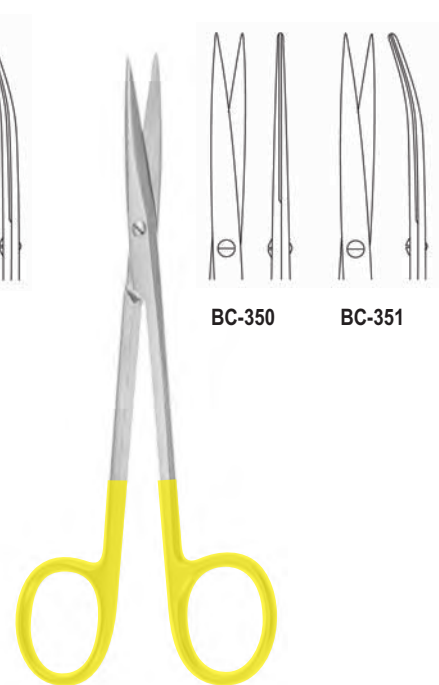

- BC-350**
- BC-351**

METZENBAUM-FINO
BC-350 - 351
14.5 cm, 5 3/4"

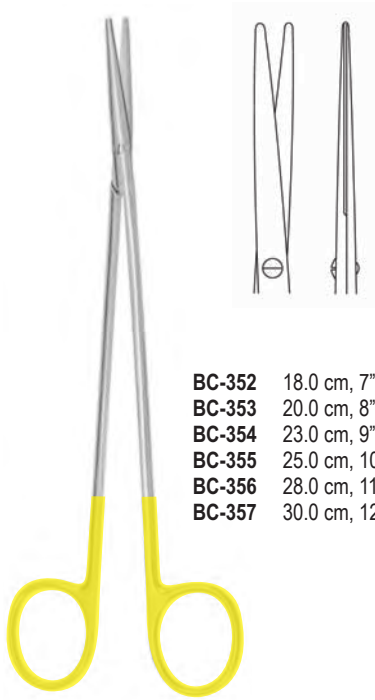

- BC-352** 18.0 cm, 7"
- BC-353** 20.0 cm, 8"
- BC-354** 23.0 cm, 9"
- BC-355** 25.0 cm, 10"
- BC-356** 28.0 cm, 11"
- BC-357** 30.0 cm, 12"

METZENBAUM-FINO
BC-352 - 357

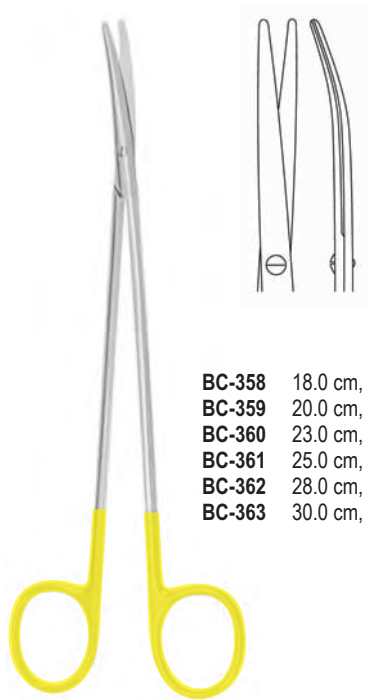

- BC-358** 18.0 cm, 7"
- BC-359** 20.0 cm, 8"
- BC-360** 23.0 cm, 9"
- BC-361** 25.0 cm, 10"
- BC-362** 28.0 cm, 11"
- BC-363** 30.0 cm, 12"

METZENBAUM-FINO
BC-358 - 363

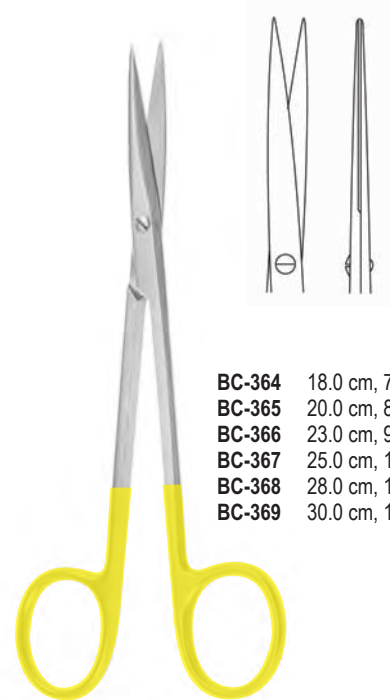

- BC-364** 18.0 cm, 7"
- BC-365** 20.0 cm, 8"
- BC-366** 23.0 cm, 9"
- BC-367** 25.0 cm, 10"
- BC-368** 28.0 cm, 11"
- BC-369** 30.0 cm, 12"

METZENBAUM-FINO
BC-364 - 369

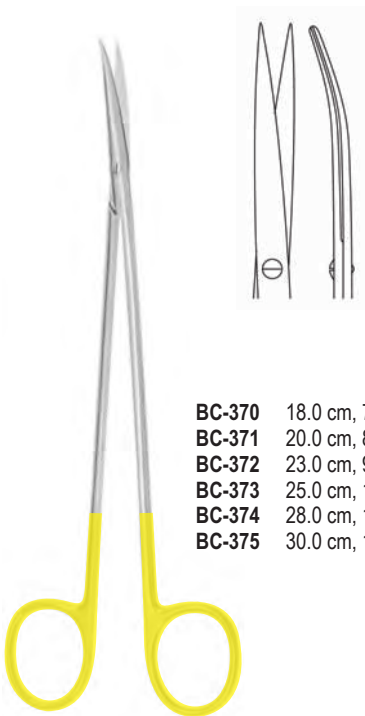

- BC-370** 18.0 cm, 7"
- BC-371** 20.0 cm, 8"
- BC-372** 23.0 cm, 9"
- BC-373** 25.0 cm, 10"
- BC-374** 28.0 cm, 11"
- BC-375** 30.0 cm, 12"

METZENBAUM-FINO
BC-370 - 375

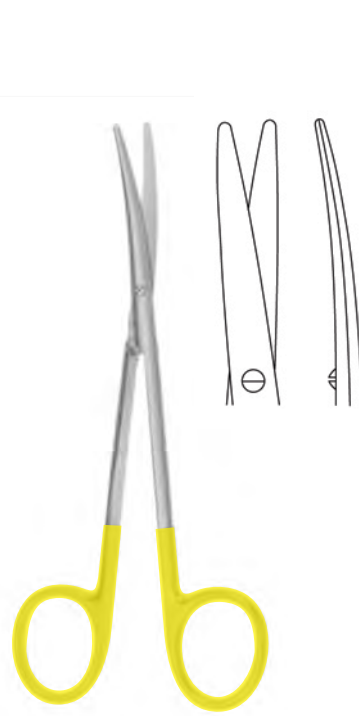

METZENBAUM-LAHEY
BC-376
14.5 cm, 5 1/2"



TOENNIS-ADSON
BC-377
17.0 cm, 6 3/4"



DISSECTING SCISSORS WITH TUNGSTEN CARBIDE EDGES

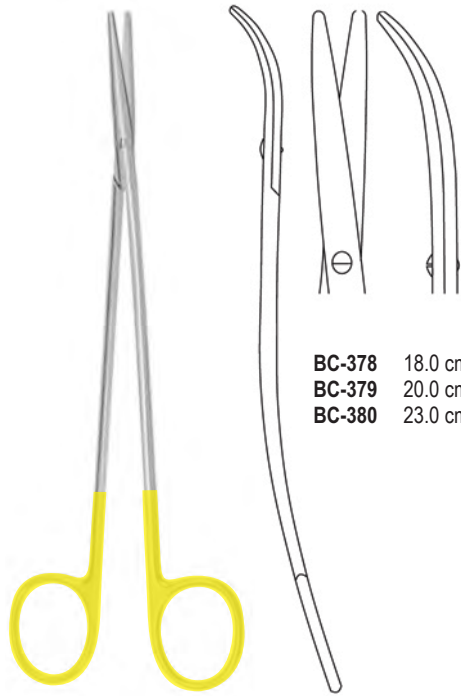

BC-378 18.0 cm, 7"
BC-379 20.0 cm, 8"
BC-380 23.0 cm, 9"

METZENBAUM-FINO
BC-378 - 380

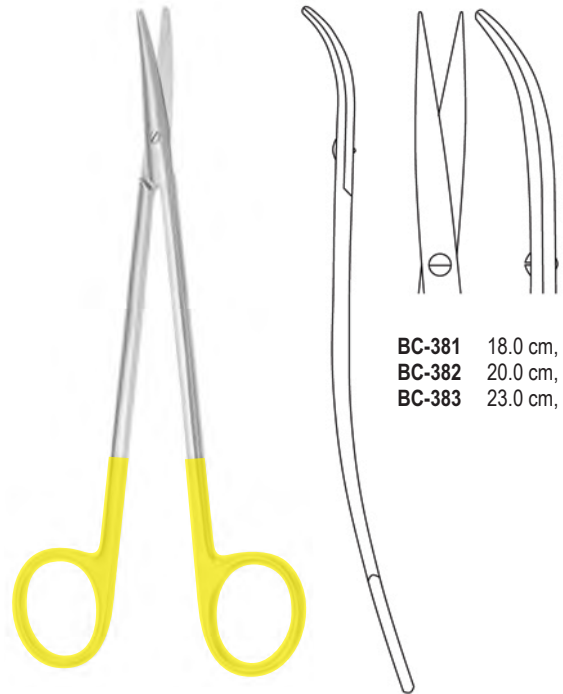

BC-381 18.0 cm, 7"
BC-382 20.0 cm, 8"
BC-383 23.0 cm, 9"

METZENBAUM-FINO
BC-381 - 383

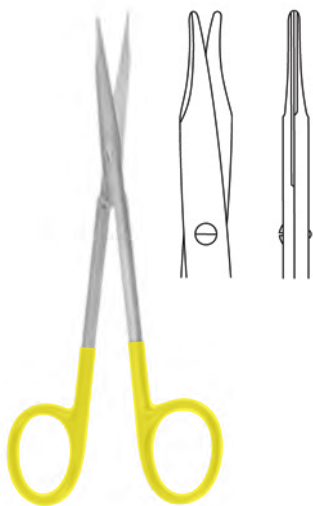

REYNOLDS
BC-384
15.0 cm, 6"

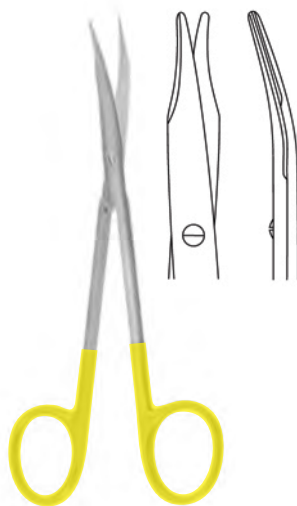

REYNOLDS
BC-385
15.0 cm, 6"



HYSTEREKTOMY
BC-386
25.5 cm, 10"



HYSTEREKTOMY
BC-387
25.5 cm, 9 3/4"



SIMS
BC-388 - 389

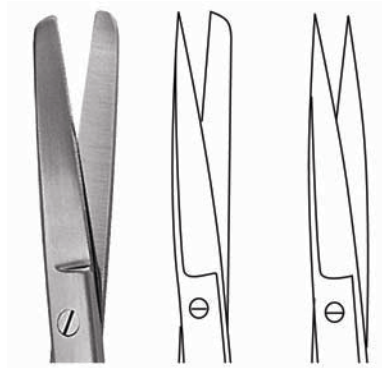

BC-388 20.0 cm, 8"
BC-389 23.0 cm, 9"



SIMS
BC-390 - 391



BC-390 20.0 cm, 8"
BC-391 23.0 cm, 9"



VASCULAR SCISSORS WITH TUNGSTEN CARBIDE EDGES



DIETHRICH
BC-392
17.5 cm, 6 5/8"



POTTS DE MARTEL
BC-393
24.0 cm, 9 1/2"



DE BAKEY
BC-394 - 395

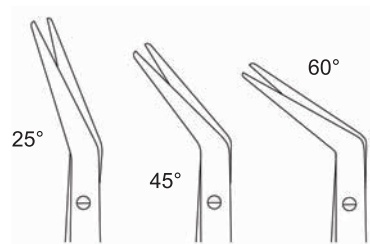

BC-394 20.0 cm, 8"
BC-395 23.0 cm, 9"

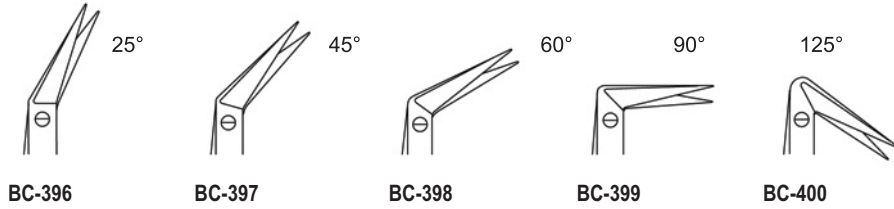
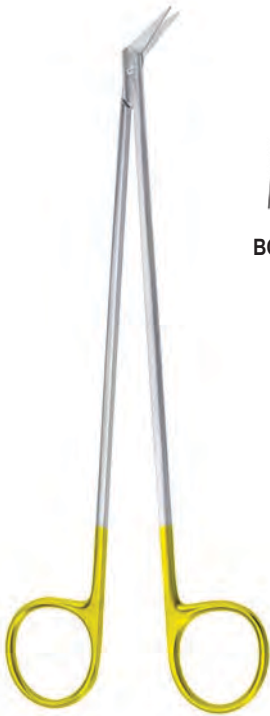

DIETRICH-HEGEMANN
BC-396 - 400
 18.0 cm, 7"

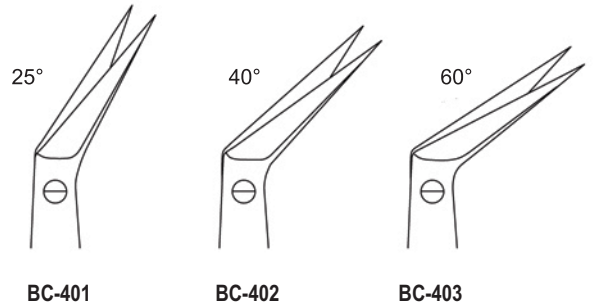
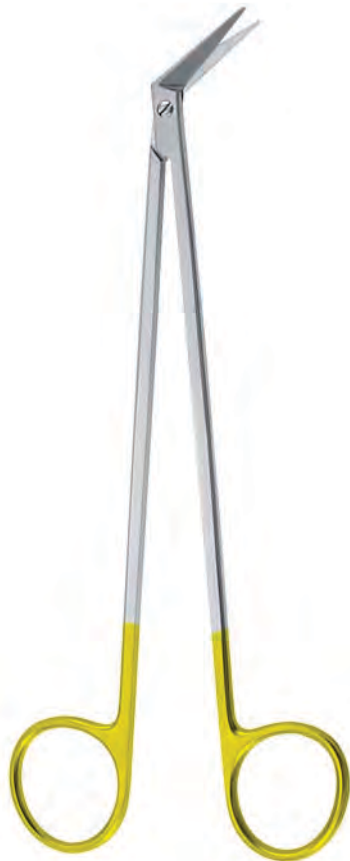

POTTS-SMITH
BC-401 - 403
 18.0 cm, 7½"



SCISSORS WITH TUNGSTEN CARBIDE EDGES

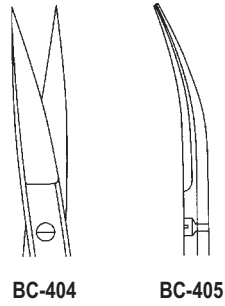

BC-404

BC-405

IRIS
BC-404 - 405
11.5 cm, 4½"

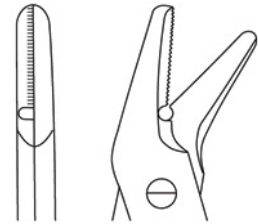

gezahnt
serrated
dentada
dentata

UNIVERSAL
BC-406
12.0 cm, 4 3/4"

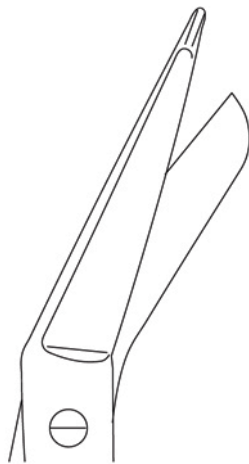

LISTER
BC-407
18.0 cm, 7"

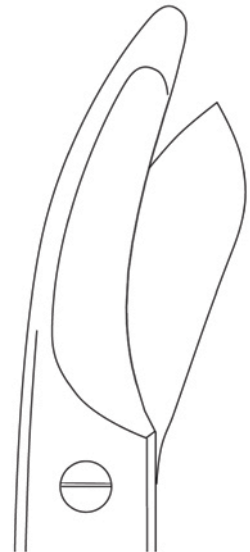

LISTER
BC-408
24.0 cm, 9½"

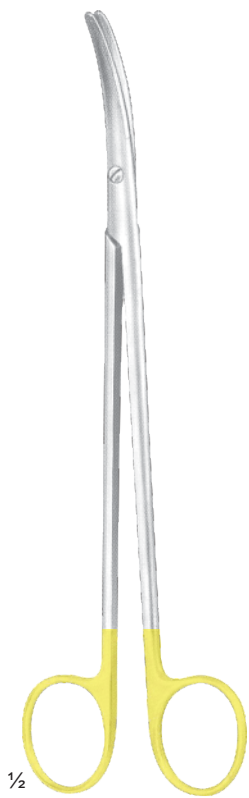

1/2

METZENBAUM-THOREK
BC-409 - BC-411

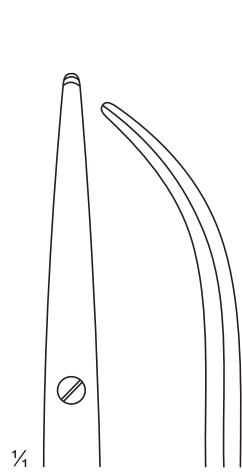

1/4

BC-409
200 mm

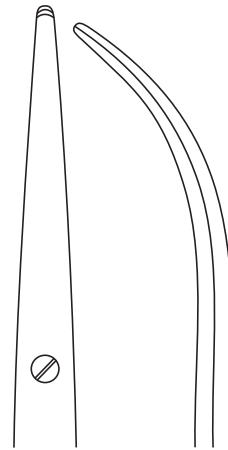

1/4

BC-410
230 mm

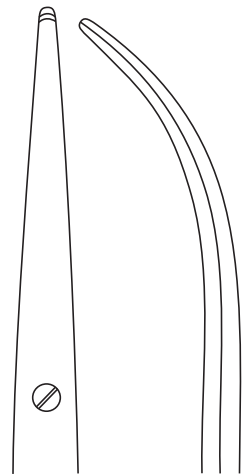

1/4

BC-411
280 mm



1/2

JOSEPH
BC-412 - 413



1/4

BC-412
14.5 cm

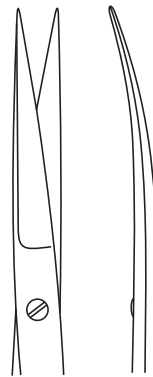

1/4

BC-413
14.5 cm



DELICATE DISSECTING SCISSORS WITH TUNGSTEN CARBIDE

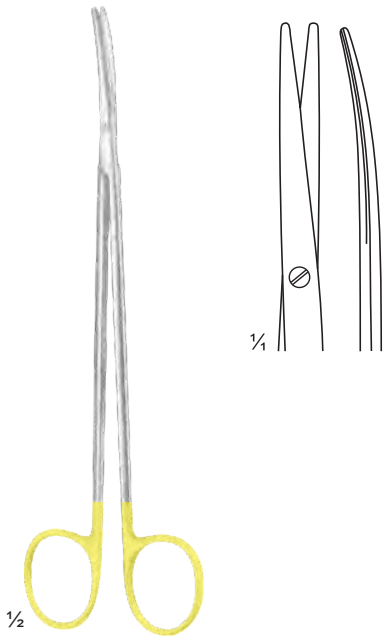

TOENNIS-ADSON
BC-414
175 mm
slender pattern



METZENBAUM-FINO
BC-415 - 416
slender pattern



BC-415
205 mm

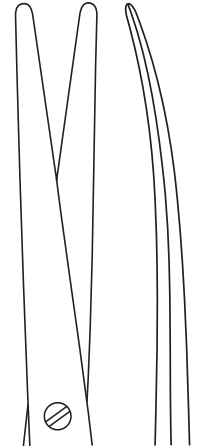

BC-416
230 mm

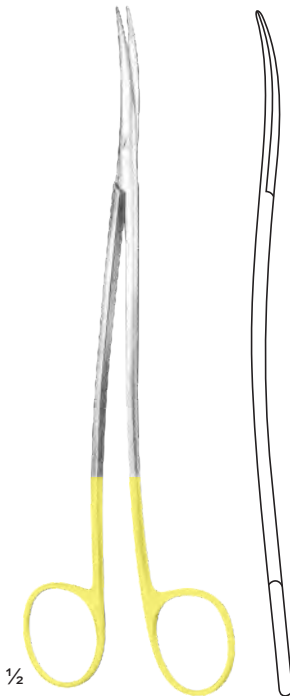

METZENBAUM-FINO
BC-417 - 419
slender pattern



BC-417
180 mm

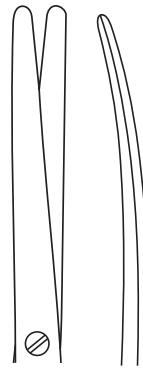

BC-418
205 mm



BC-419
230 mm

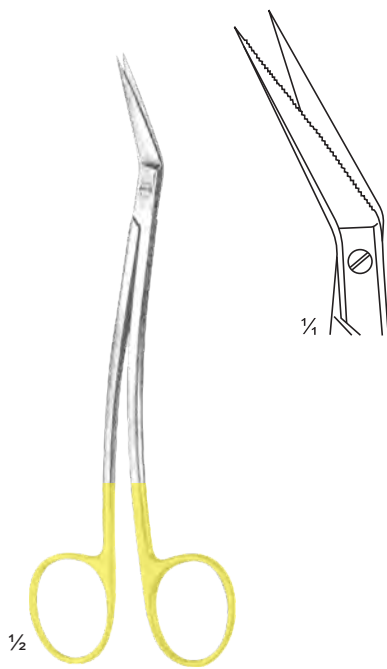

LOCKLIN
BC-420
160 mm
one toothed cutting edge

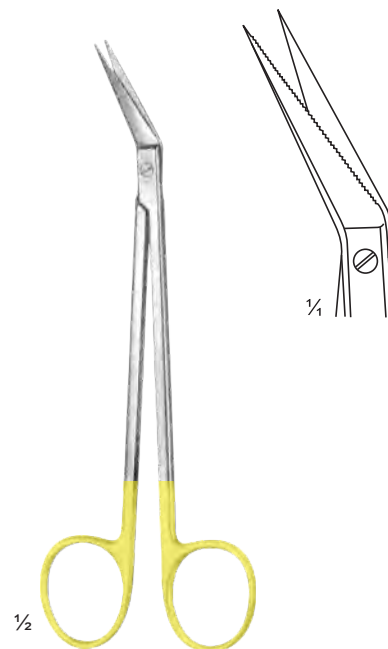

LOCKLIN
BC-421
160 mm
one toothed cutting edge



SUPER-CUT SCISSORS



MAYO
BC-422 - 423
17.0 cm, 6 3/4"



BC-422



BC-423

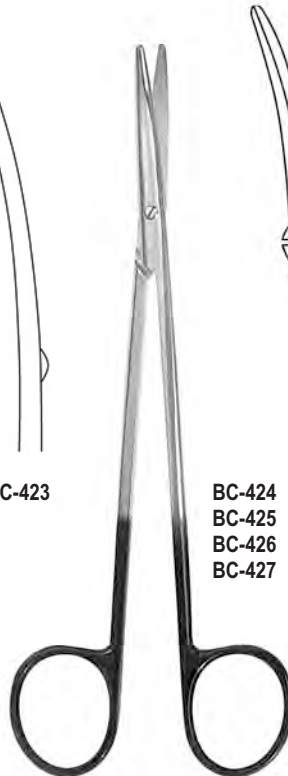

METZENBAUM
BC-424 - 427

- BC-424 14.5 cm, 5 3/4"
- BC-425 18.0 cm, 7"
- BC-426 20.0 cm, 8"
- BC-427 23.0 cm, 9"

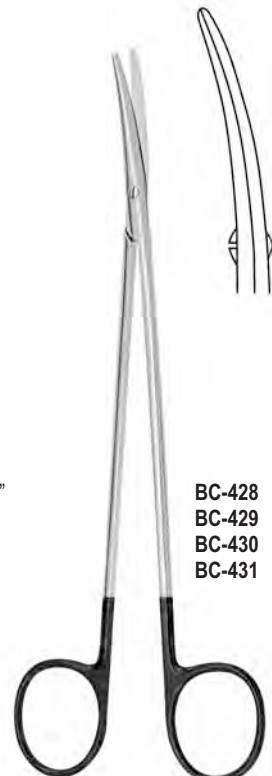

METZENBAUM-FINO
BC-428 - 431

- BC-428 14.5 cm, 5 3/4"
- BC-429 18.0 cm, 7"
- BC-430 20.0 cm, 8"
- BC-431 23.0 cm, 9"

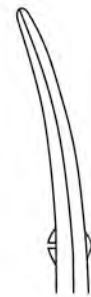

KAYE FACE LIFT
BC-432 - 433

- BC-432 15.0 cm, 6"
- BC-433 19.0 cm, 7 1/2"



JABALEY
BC-434
13.0 cm, 5"



ENDARTERECTOMY
BC-435
18.0 cm, 7"



TOENNIS-ADSON
BC-436
17.0 cm, 6 3/4"





BC-437

BC-438

STRABISMUS
BC-437 - 438
11.5 cm, 4½"



JAMISON
BC-439 15.0 cm, 6"
BC-440 18.0 cm, 7"



REYNOLDS
BC-441
12.5 cm, 5"



BABY-METZENBAUM
BC-442 11.0 cm, 4 3/8"
BC-443 14.5 cm, 5 3/4"



IRIS
BC-444
11.0 cm, 4 3/8"



IRIS
BC-445
11.0 cm, 4 3/8"



STEVENS TENOTOMY
BC-446
11.0 cm, 4 3/8"



STEVENS TENOTOMY
BC-447
11.0 cm, 4 3/8"



SUPER-CUT SCISSORS



PAR TYPE
BC-448
12.0 cm, 4 3/4"



PAR TYPE
BC-449
12.0 cm, 4 3/4"



POTTS
BC-450 - 452
19.0 cm, 7 1/2"



BC-450

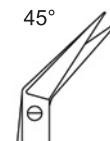

BC-451

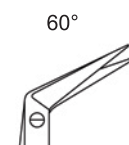

BC-452



BC-453
14.5 cm, 5 3/4"



COTTLE
BC-454
16.5 cm, 6 1/2"

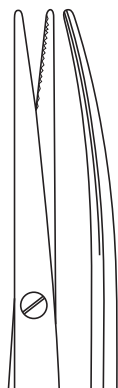

BC-455
14.5 cm



BC-456
18 cm



BC-457
20.5 cm



BC-458
23 cm



BC-459
25 cm



BC-460
30 cm



LIGATURE SCISSORS
BC-455 - 460
for synthetic suture material,
one toothed cutting edge



LIGATURE SCISSORS WITH
TUNGSTEN CARBIDE AND SUPER-CUT EDGES

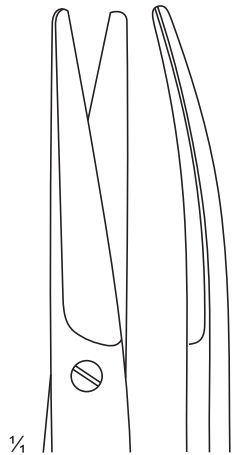

BC-461
14.5 cm

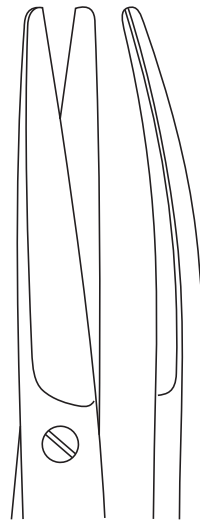

BC-462
17 cm

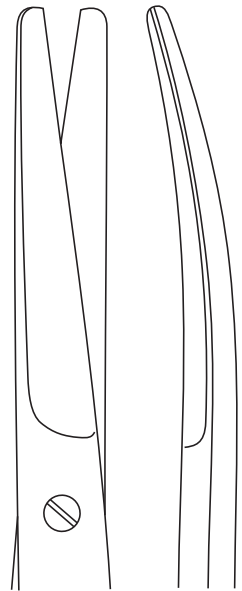

BC-463
23 cm

LIGATURE SCISSORS
BC-461 - 463
for synthetic suture material,
one toothed cutting edge



IRIS
BC-464
11.5 cm



BC-465
18 cm



BC-466
20 cm



BC-467
23 cm



METZENBAUM
BC-465 - 470



BC-468
26 cm



BC-469
28.5 cm

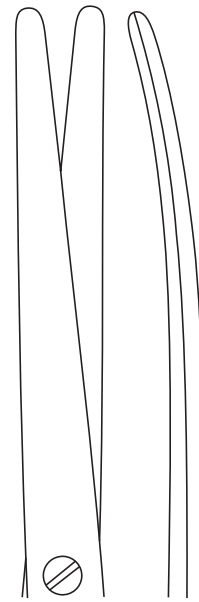

BC-470
31 cm