



Page 01–51

○ Spinal & Orthopaedic Surgery Instruments

LAMINECTOMY PUNCH

Kerrison Laminectomy Punch
40° UPWARD Jaw Angle

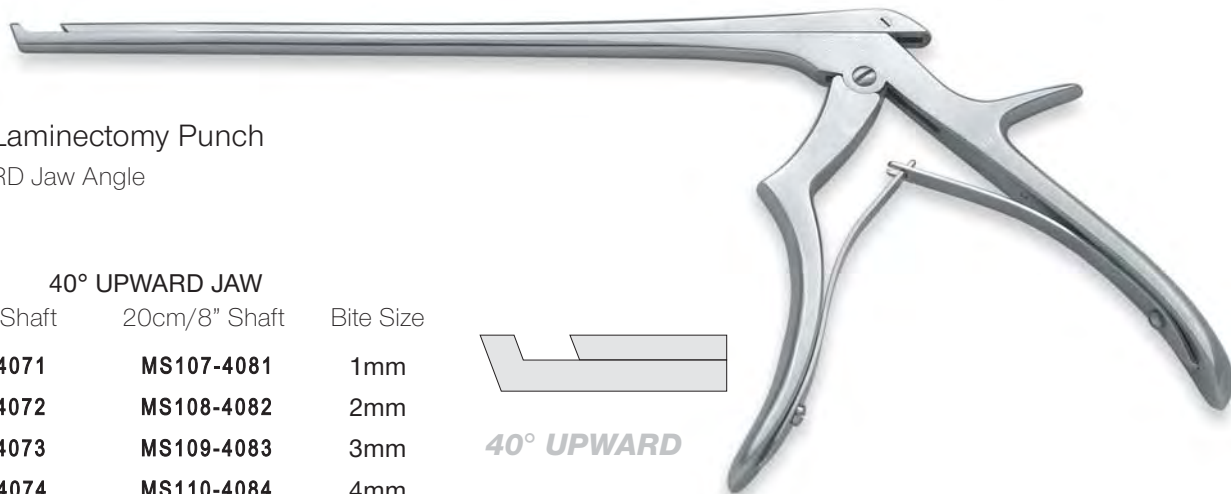

40° UPWARD JAW

18cm/7" Shaft	20cm/8" Shaft	Bite Size
MS101-4071	MS107-4081	1mm
MS102-4072	MS108-4082	2mm
MS103-4073	MS109-4083	3mm
MS104-4074	MS110-4084	4mm
MS105-4075	MS111-4085	5mm
MS106-4076	MS112-4086	6mm

40° DOWNWARD JAW

18cm/7" Shaft	20cm/8" Shaft	Bite Size
MS113-4071	MS119-4081	1mm
MS114-4072	MS120-4082	2mm
MS115-4073	MS121-4083	3mm
MS116-4074	MS122-4084	4mm
MS117-4075	MS123-4085	5mm
MS118-4076	MS124-4086	6mm

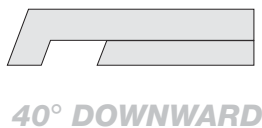

Kerrison 'Black Line' Laminectomy Punch
with Bone Ejector & Titanium Coating
40° UPWARD Jaw Angle



40° UPWARD JAW

18cm/7" Shaft	20cm/8" Shaft	Bite Size
MS125-4071T	MS131-4081T	1mm
MS126-4072T	MS132-4082T	2mm
MS127-4073T	MS133-4083T	3mm
MS128-4074T	MS134-4084T	4mm
MS129-4075T	MS135-4085T	5mm
MS130-4076T	MS136-4086T	6mm

*(without ejector)



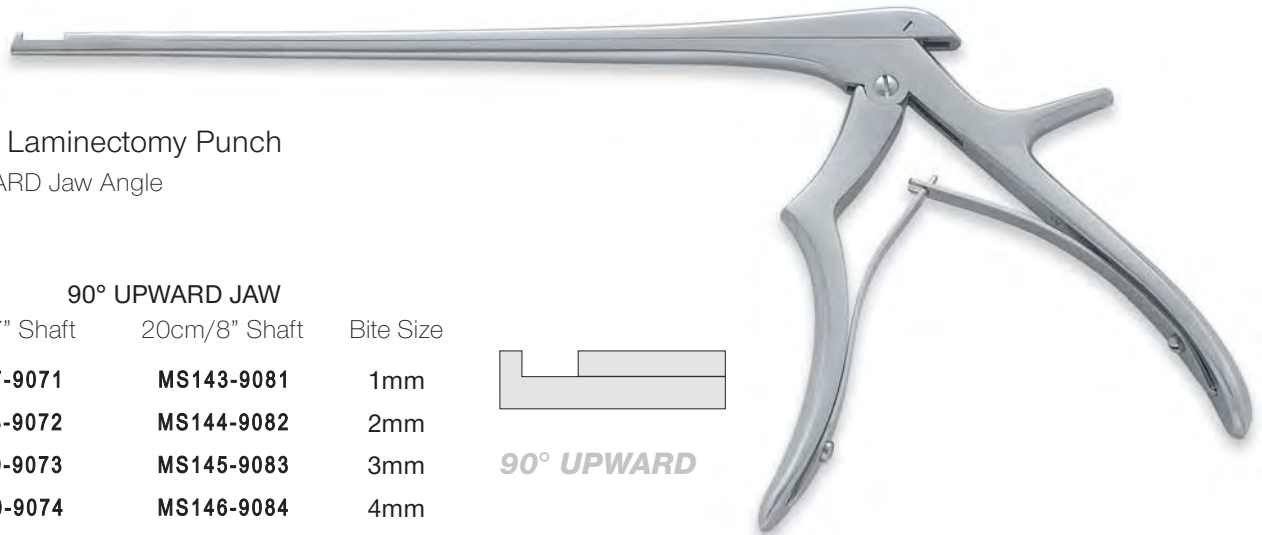

Kerrison Laminectomy Punch

90° UPWARD Jaw Angle

90° UPWARD JAW

18cm/7" Shaft	20cm/8" Shaft	Bite Size
MS137-9071	MS143-9081	1mm
MS138-9072	MS144-9082	2mm
MS139-9073	MS145-9083	3mm
MS140-9074	MS146-9084	4mm
MS141-9075	MS147-9085	5mm
MS142-9076	MS148-9086	6mm



90° UPWARD

90° DOWNWARD JAW

18cm/7" Shaft	20cm/8" Shaft	Bite Size
MS149-9071	MS155-9081	1mm
MS150-9072	MS156-9082	2mm
MS151-9073	MS157-9083	3mm
MS152-9074	MS158-9084	4mm
MS153-9075	MS159-9085	5mm
MS154-9076	MS160-9086	6mm



90° DOWNWARD

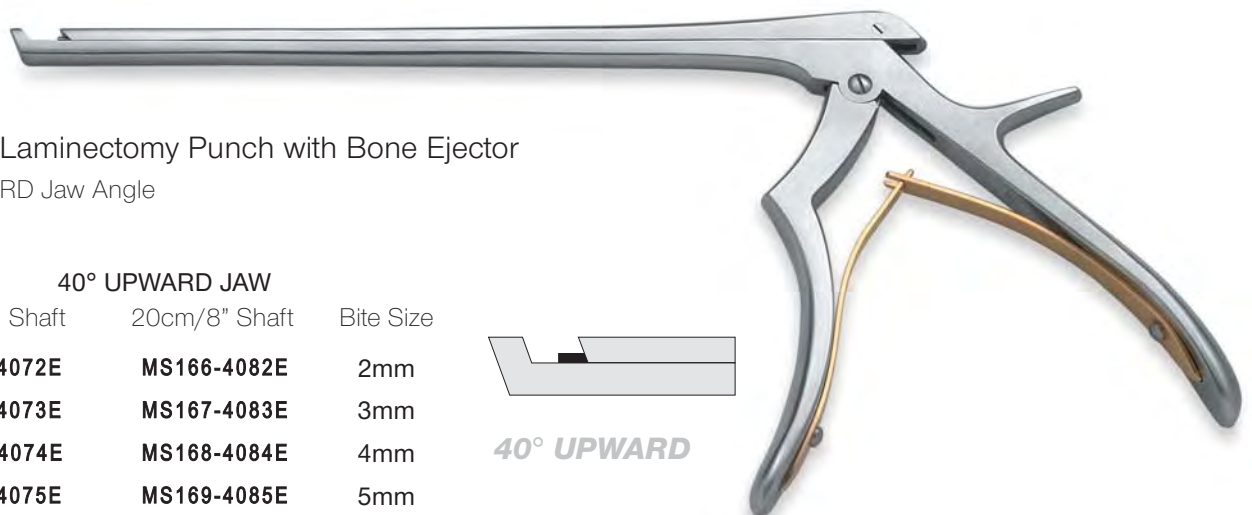

Kerrison Laminectomy Punch with Bone Ejector

40° UPWARD Jaw Angle

40° UPWARD JAW

18cm/7" Shaft	20cm/8" Shaft	Bite Size
MS161-4072E	MS166-4082E	2mm
MS162-4073E	MS167-4083E	3mm
MS163-4074E	MS168-4084E	4mm
MS164-4075E	MS169-4085E	5mm
MS165-4076E	MS170-4086E	6mm



40° UPWARD

LAMINECTOMY PUNCH

Kerrison Thin Footplate Laminectomy Punch

40° UPWARD Jaw Angle



40° UPWARD JAW **WITH THIN FOOTPLATE**

18cm/7" Shaft	20cm/8" Shaft	Bite Size
MS171-4072T	MS176-4082T	2mm
MS172-4073T	MS177-4083T	3mm
MS173-4074T	MS178-4084T	4mm
MS174-4075T	MS179-4085T	5mm
MS175-4076T	MS180-4086T	6mm

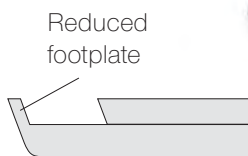

- A reduced footplate thickness useful for a restricted operating area

40° UPWARD

Wide Opening Kerrison Laminectomy Punch

40° UPWARD Jaw Angle



40° UPWARD JAW

20cm/8" Shaft	Bite Size
MS181-4082	2mm
MS182-4083	3mm
MS183-4084	4mm
MS184-4085	5mm
MS185-4086	6mm

- Wide opening jaws allowing the surgeon to envelope more bone

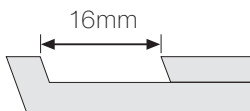

40° UPWARD

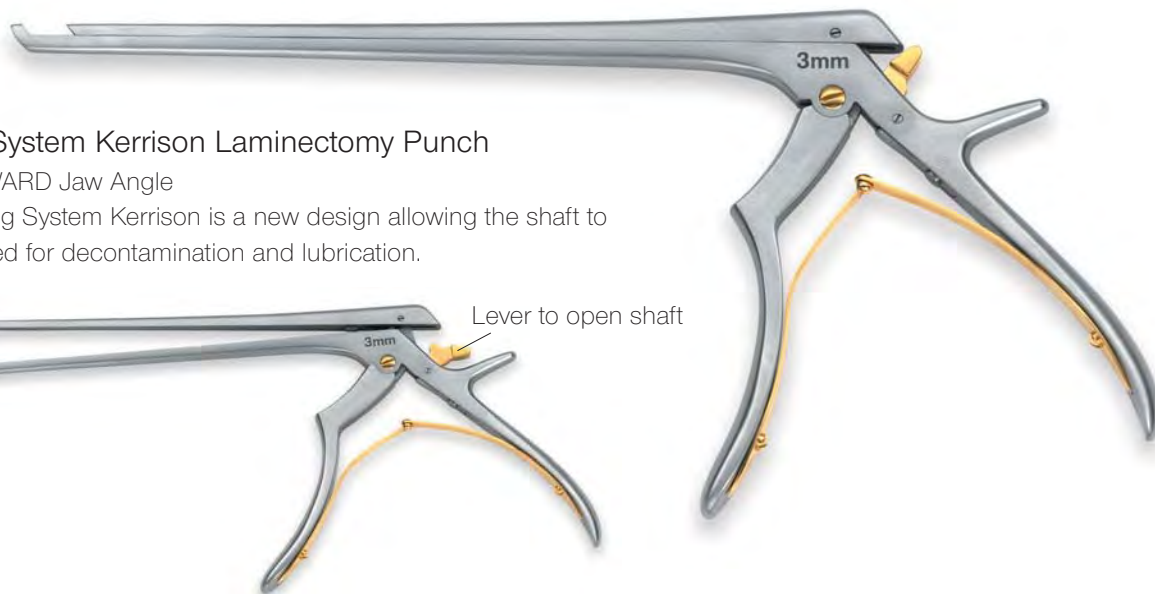

Swing System Kerrison Laminectomy Punch

40° UPWARD Jaw Angle

The Swing System Kerrison is a new design allowing the shaft to be opened for decontamination and lubrication.

40° UPWARD JAW		Bite Size
18cm/7" Shaft	20cm/8" Shaft	
MS186-4071D	MS192-4081D	1mm
MS187-4072D	MS193-4082D	2mm
MS188-4073D	MS194-4083D	3mm
MS189-4074D	MS195-4084D	4mm
MS190-4075D	MS196-4085D	5mm
MS191-4076D	MS197-4086D	6mm

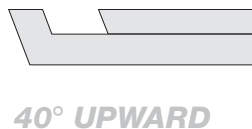

- Maintains efficient function of instrument
- Ensures decontamination of instrument
- Easy to open
- Available with Bone Ejector - suffix E

Love Kerrison Punch

40° UPWARD Jaw Angle

40° UPWARD JAW	
20cm/8" Shaft	Bite Size
MS198-4082	2mm
MS199-4083	3mm
MS200-4084	4mm
MS201-4085	5mm

- Larger handle on this Kerrison Punch





LAMINECTOMY PUNCH



Long Anterior Kerrison Laminectomy Punch
40° UPWARD Jaw Angle

40° UPWARD JAW

28cm/11" Shaft	Bite Size
MS202-4002	2mm
MS203-4003	3mm
MS204-4004	4mm
MS205-4005	5mm
MS206-4006	6mm

- A longer Kerrison Punch to give the surgeon greater reach in the deeper Anterior area



Curved Foramenotomy Punch
40° UPWARD Jaw Angle

40° UPWARD JAW

20cm/8" Shaft	Bite Size
MS207-4082	2mm
MS208-4083	3mm
MS209-4084	4mm

- Curved shaft designed to improve access to the Foramen

Ferris-Smith Kerrison Laminectomy Punch
40° UPWARD Jaw Angle with modified ring handle



40° UPWARD

40° UPWARD JAW

18cm/7" Shaft	20cm/8" Shaft	Bite Size
MS210-4072	MS214-4082	2mm
MS211-4073	MS215-4083	3mm
MS212-4074	MS216-4084	4mm
MS213-4075	MS217-4085	5mm
MS213-4076	MS218-4086	6mm

Osteo-Rotating Punch
40° UPWARD Jaw Angle



40° UPWARD JAW

18cm/7" Shaft	21cm/8 1/4" Shaft	Bite Size
MS219-40	MS224-40	0.6mm
MS220-41	MS225-41	1mm
MS221-42	MS226-42	2mm
MS222-43	MS227-43	3mm
MS223-44	MS228-44	4mm

- Thin foot plate for tight areas
- Full 360° rotation of shaft
- Removable shaft allows cleaning & replacement
- Ergonomically shaped handle



DISC RONGEURS

Intervertebral Disc Rongeur



STRAIGHT JAW

15cm/6" Shaft	18cm/7" Shaft	20cm/8" Shaft	Bite Size
MS229-15S	MS236-18S	MS243-20S	1.5mm
MS230-15S	MS237-18S	MS244-20S	2mm
MS231-15S	MS238-18S	MS245-20S	3mm
MS232-15S	MS239-18S	MS246-20S	4mm
MS233-15S	MS240-18S	MS247-20S	5mm
MS234-15S	MS241-18S	MS248-20S	6mm
MS235-15S	MS242-18S	MS249-20S	7mm

Intervertebral Disc Rongeur



40° ANGLED UPWARD JAW

15cm/6" Shaft	18cm/7" Shaft	20cm/8" Shaft	Bite Size
MS250-15U	MS257-18U	MS264-20U	1.5mm
MS251-15U	MS258-18U	MS265-20U	2mm
MS252-15U	MS259-18U	MS266-20U	3mm
MS253-15U	MS260-18U	MS267-20U	4mm
MS254-15U	MS261-18U	MS268-20U	5mm
MS255-15U	MS262-18U	MS269-20U	6mm
MS256-15U	MS263-18U	MS270-20U	7mm

Intervertebral Disc Rongeur



40° ANGLED DOWNWARD JAW

15cm/6" Shaft	18cm/7" Shaft	20cm/8" Shaft	Bite Size
MS271-15D	MS278-18D	MS285-18D	1.5mm
MS272-15D	MS279-18D	MS286-18D	2mm
MS273-15D	MS280-18D	MS287-18D	3mm
MS274-15D	MS281-18D	MS288-18D	4mm
MS275-15D	MS282-18D	MS289-18D	5mm
MS276-15D	MS283-18D	MS290-18D	6mm
MS277-15D	MS284-18D	MS291-18D	7mm

Williams Discectomy Rongeur

14cm/5½" Shaft

MS292-14

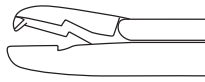

- Single Toothed Cup 1mm Bite



'Pea Pod' Disc Rongeur

15cm/6" Shaft

10mm length Jaw

Bite Size

- MS293-15** 2mm
- MS294-15** 3mm
- MS295-15** 4mm



Nicola Micro Cupped Biopsy Forceps

16.5cm/6½" Shaft



MS296-16



Ø 2.5mm

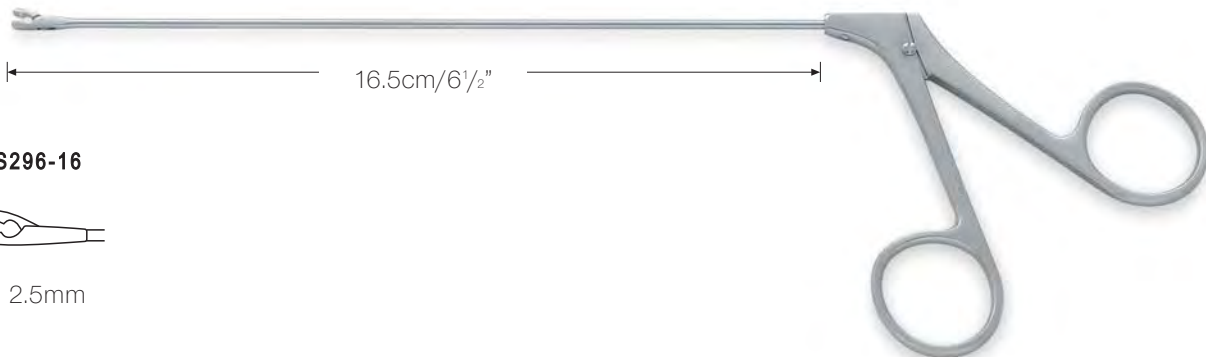

DISC RONGEURS

Caspar Toothed Disc Rongeur



- Serrated and fenestrated jaws

STRAIGHT JAW

16cm/6 ¹ / ₄ " Shaft	18cm/7" Shaft	Bite Size
MS297-16	MS301-18	2mm
MS298-16	MS302-18	3mm
MS299-16	MS303-18	4mm
MS300-16	MS304-18	5mm

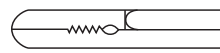

UPWARD JAW

16cm/6 ¹ / ₄ " Shaft	18cm/7" Shaft	Bite Size
MS305-16	MS309-18	2mm
MS306-16	MS310-18	3mm
MS307-16	MS311-18	4mm
MS308-16	MS312-18	5mm

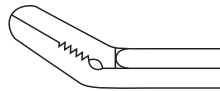

DOWNWARD JAW

16cm/6 ¹ / ₄ " Shaft	18cm/7" Shaft	Bite Size
MS313-16	MS317-18	2mm
MS314-16	MS318-18	3mm
MS315-16	MS319-18	4mm
MS316-16	MS320-18	5mm

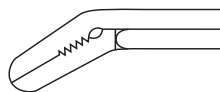

Schlesinger Toothed Rongeur

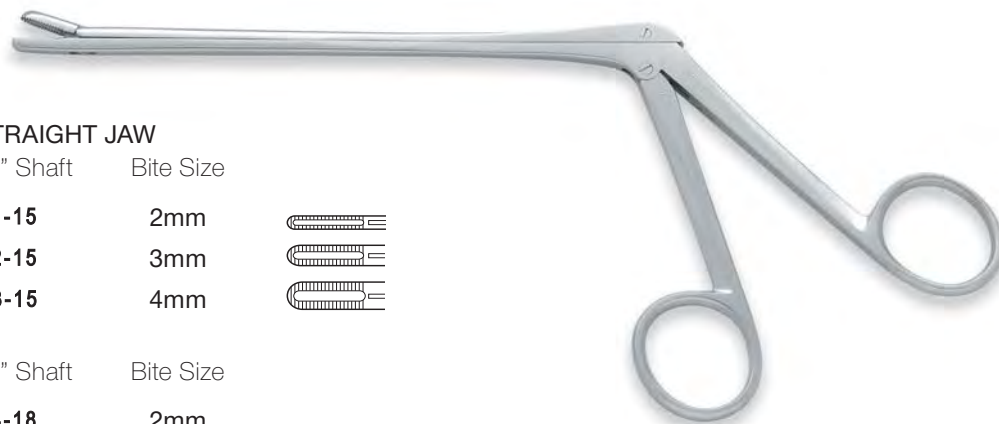

STRAIGHT JAW

15cm/6" Shaft	Bite Size
MS321-15	2mm
MS322-15	3mm
MS323-15	4mm

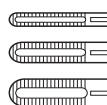

18cm/7" Shaft	Bite Size
MS324-18	2mm
MS325-18	3mm
MS326-18	4mm

Ferris-Smith Disc Rongeur

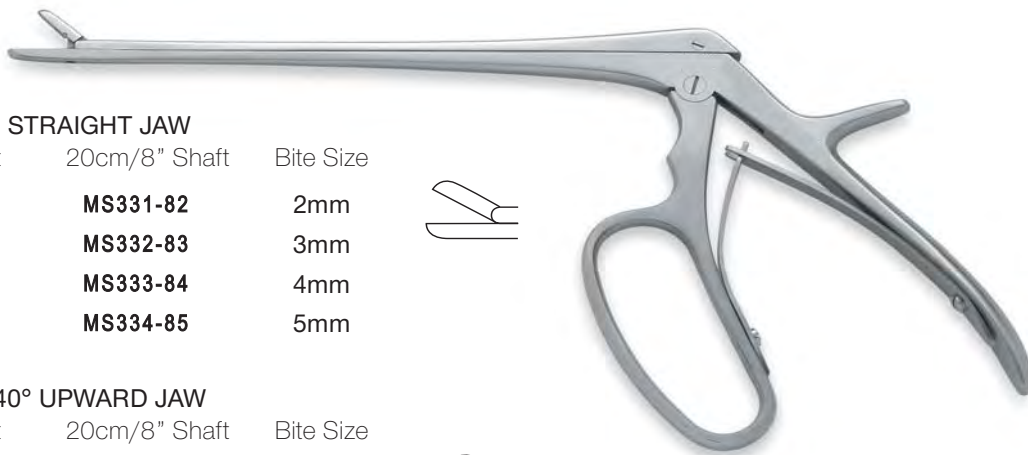

STRAIGHT JAW		Bite Size
18cm/7" Shaft	20cm/8" Shaft	
MS327-72	MS331-82	2mm
MS328-73	MS332-83	3mm
MS329-74	MS333-84	4mm
MS330-75	MS334-85	5mm

40° UPWARD JAW		Bite Size
18cm/7" Shaft	20cm/8" Shaft	
MS335-72	MS339-82	2mm
MS336-73	MS340-83	3mm
MS337-74	MS341-84	4mm
MS338-75	MS342-85	5mm

Anterior Disc Rongeur

28cm/11" Shaft



Straight	Upward	Bite Size
MS343-2	MS347-2	2mm
MS344-3	MS348-3	3mm
MS345-4	MS349-4	4mm
MS346-5	MS350-5	5mm

- Longer 28cm shaft for greater reach in the Anterior Approach

Anterior Pituitary Rongeur

35cm/13½" Shaft



STRAIGHT	UPWARD	Bite Size
MS351-35S	MS355-35U	2.4mm
MS352-35S	MS356-35U	4mm
MS353-35S	MS357-35U	6mm with teeth
MS354-35S	MS358-35U	8mm with teeth

- Extra long length shaft for deeper areas



BONE NIBBLERS & CUTTERS

Lempert Bone Nibbler

Single Action
19cm/7 1/2"

3mm Bite
MS359-19

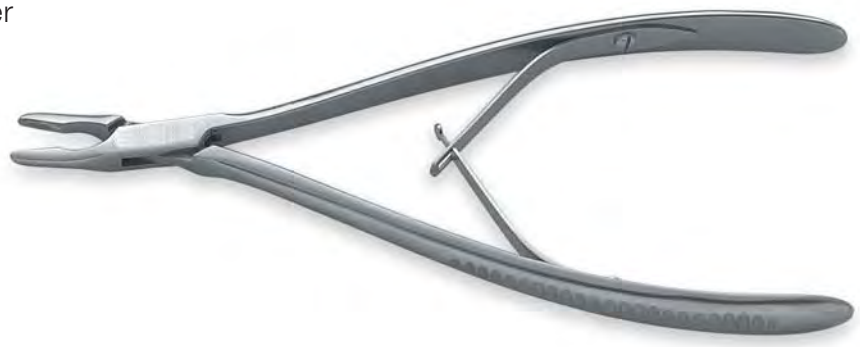

Luer Bone Nibbler

Single Action
18cm/7"

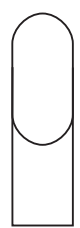

Straight
8mm Bite
MS360-18



Curved
8mm Bite
MS361-18

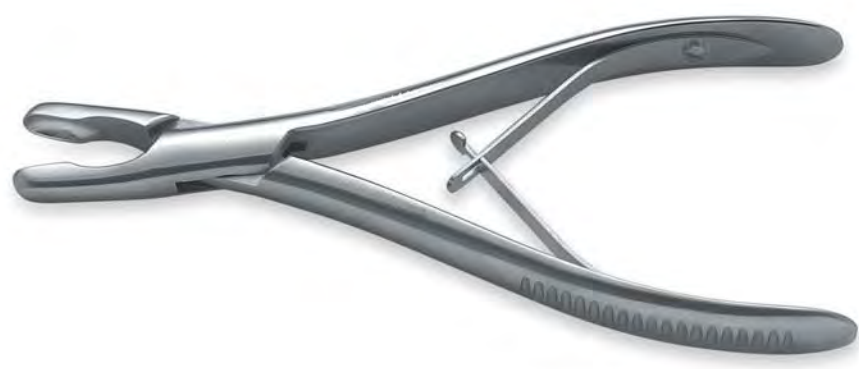

Adsons Bone Nibbler

Single Action
20cm/8"



7mm Bite
MS362-20

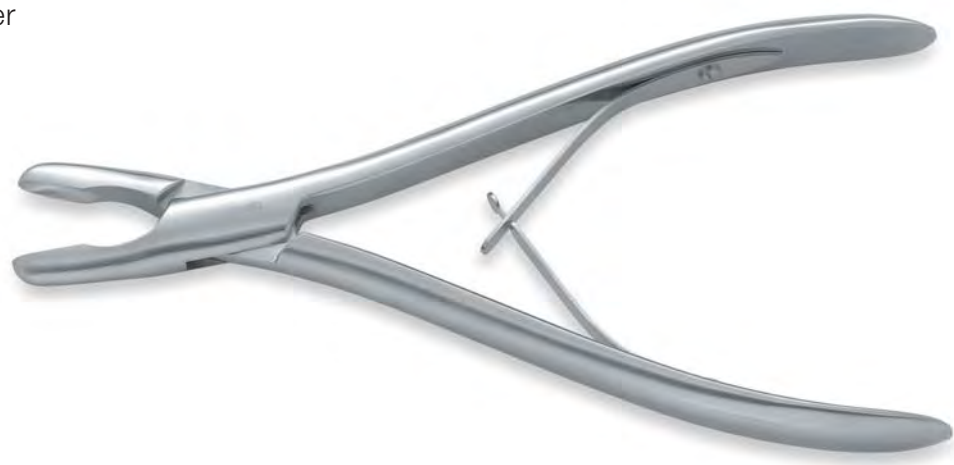

Pennybacker Bone Nibbler

Single Action

20cm/8"



4mm Bite

MS363-20



Northfields Bone Nibbler

Single Action

20cm/8"

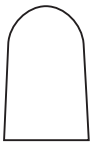

10mm Bite

MS364-20



'Rat Toothed' Bone Nibbler

Single Action

21cm/8¹/₄"

8mm Bite

MS365-21



• 3 x 3 Teeth

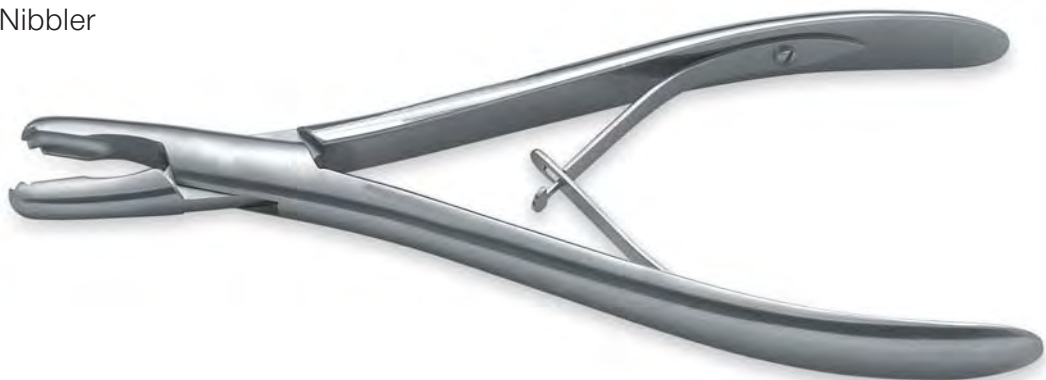



BONE NIBBLERS & CUTTERS

Zielke Intervertebral Rongeur
Angled Parallel Jaws

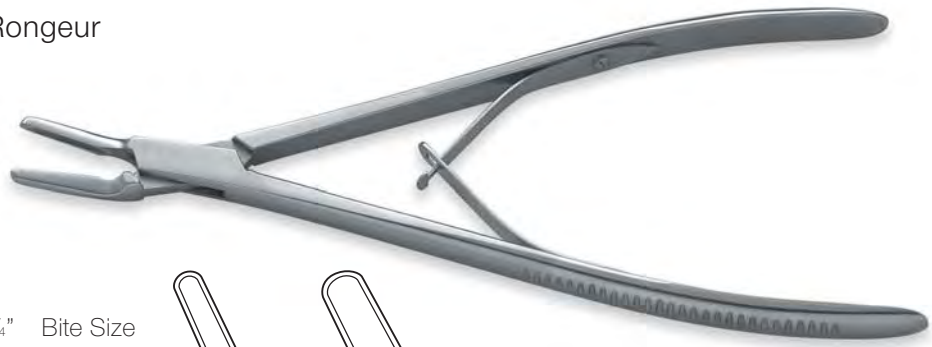

21cm/8¼"	25cm/9¾"	Bite Size
MS366-21	MS368-25	3mm
MS367-21	MS369-25	5mm

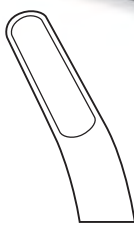
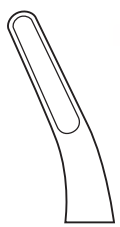

3mm Bite

5mm Bite

Matzen Intervertebral Rongeur
20cm/8"

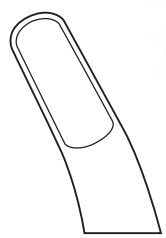
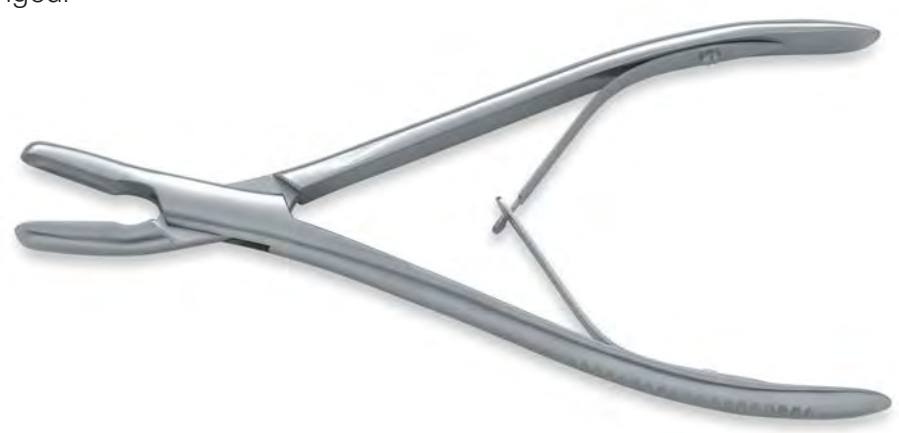

8mm Bite
MS370-20

Beyer Bone Nibbler
Curved Double Action
18cm/7"

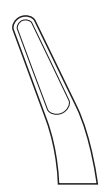

4mm Bite
MS371-18

Jansen Bone Nibbler

Curved Double Action
18cm/7"

5mm Bite
MS372-18

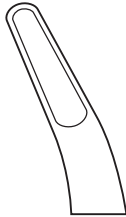

Marquardt Bone Nibbler

Curved Double Action
20cm/8"

3mm Bite
MS373-20

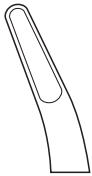

Smith-Peterson Bone Nibbler

Double Action
24cm/9½"

Straight	Light Curve	Bite Size
MS374-24	MS378-24	3mm
MS375-24	MS379-24	4mm
MS376-24	MS380-24	5mm
MS377-24	MS381-24	6mm



Straight

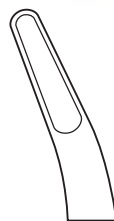

Light Curve



BONE NIBBLERS

Stille-Luer Bone Nibbler

Double Action
22cm/8³/₄"

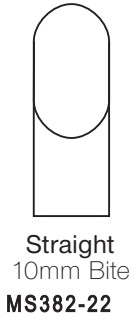

'Mr Blobby' Stille-Luer Bone Nibbler

Double Action
26cm/10¹/₄"

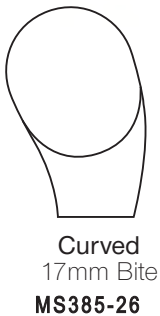
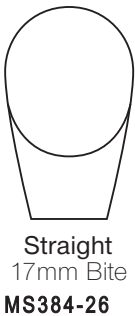

Leksell Bone Nibbler

Double Action Angled
24cm/9¹/₂"

Angled Jaw	Bite Size
MS386-24	3mm
MS387-24	5mm
MS388-24	8mm



Echlin Duckbill Nibbler
23cm/9"



2mm Bite
MS389-23

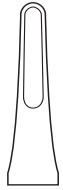

3mm Bite
MS390-23

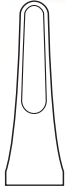

4mm Bite
MS391-23

Long Anterior Leksell Bone Nibbler

Double Action
30cm/12"

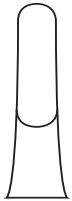

5mm Bite
MS392-30



8mm Bite
MS393-30

Sypert Bone Nibbler

Double Action - very long
36cm/14 1/4"



5mm Bite
MS394-36



8mm Bite
MS395-36



BONE CUTTERS

McIndoe Bone Cutters

18cm/7"



MS396-18



Stille-Liston Bone Cutters

27cm/10³/₄"



Straight

MS397-27



Angled

MS398-27



Liston-Key-Horsley Bone Cutters

27cm/10³/₄"



MS399-27



Drill Guide

- MS400-00** Right (illustrated)
- MS401-10** Left



Distraction Retractor

- MS402-00** Right (illustrated)
- MS403-10** Left

- For retraction of the vertebral body in the cervical spine to allow access to the disc
- Less instrumentation in the disc space
- Distraction screws are secured into the vertebral body either side of the disc, the retractor is then slid over the screws and retracted

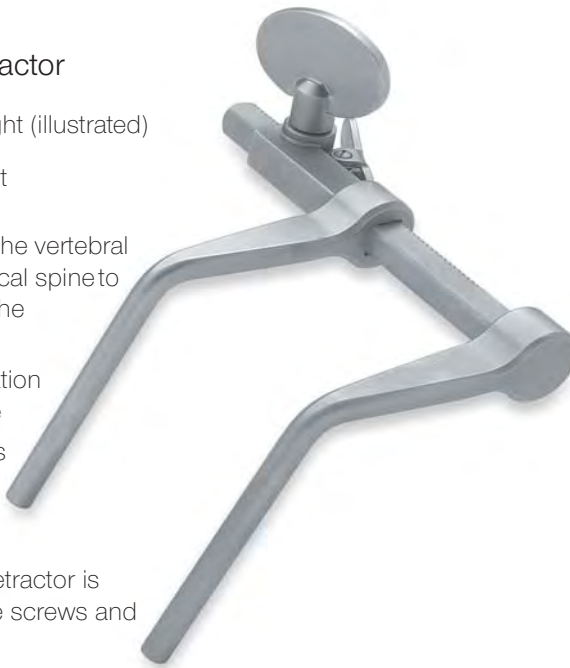

Vertebral Body Distraction Set

MS404-00

Complete set consisting of:

Qty	Order Code	Description
1	MS405-00	Retractor Right
1	MS406-00	Drill Guide Right
1	MS407-00	Screw Driver
1	MS408-00	Distraction Drill
1	MS409-14	Distraction Screws 14mm quantity 2

Distraction Screws

- 7cm post length



Supplied
Sterile in
Boxes of 10 Length

- MS411-12** 12mm
- MS412-14** 14mm
- MS413-16** 16mm

Distraction Drill

MS410-00

- For pre-drilling pilot holes for screws with drill guide 2mm



Screw Driver

MS414-00





LAMINA & VERTEBRAL SPREADERS

Cervical Vertebral Spreader

13cm/5 1/4"

MS415-85

Depth
85mm

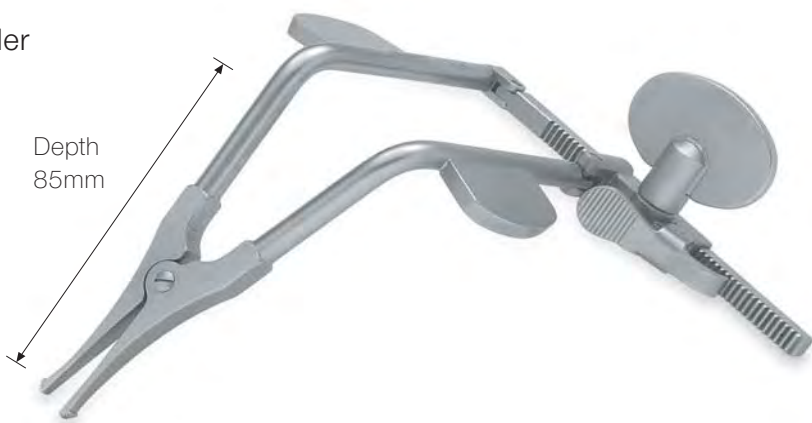

Cloward Cervical Spreader

17cm/6 3/4"

Max opening 20mm

MS416-17

Depth
50mm



Cloward Lamina Spreader

15cm/6"

MS417-70

Depth
70mm



Baby Inge Lamina Spreader

18cm/7"

MS418-18

7mm



Inge Lamina Spreader

24cm/9½". Max opening 50mm

MS419-24

10mm



20mm



Scaglietti Lamina Spreader

With speed lock

28cm/11"

MS420-28



Long Anterior Lamina Spreader

28cm/11"

Max opening 40mm

MS421-28

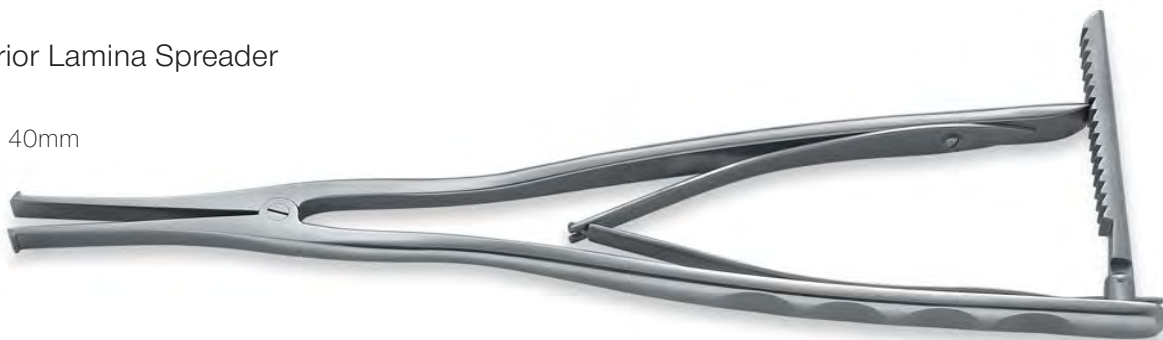



HAND HELD RETRACTORS

Meyerding Retractor
22.5cm/9"



	Blade size
MS422-22	50mm x 16mm
MS423-22	75mm x 25mm
MS424-22	90mm x 50mm

Langenbeck Retractor
21.5cm/8½"



	Blade size
MS425-21	22mm x 6mm
MS426-21	45mm x 13mm
MS427-21	65mm x 25mm
MS428-21	90mm x 20mm



Taylor Hip Retractor
19cm/7½"

	Depth
MS429-19	70mm
MS430-19	85mm
MS431-19	100mm

Cloward Style
Blade
Retractor
11cm/4¼"



	Width
MS432-11	13mm
MS433-11	18mm
MS434-11	20mm

Gelpi Laminectomy Retractor

Sharp Prongs
16cm/6 1/2"

Prong depth

- MS435-16** 30mm
- MS436-16** 50mm
- MS437-16** 70mm



Hardman Retractor

20cm/8"

Prong depth

- MS438-20** 50mm equal prongs
- MS439-20** long prong - Left*
- MS440-20** long prong - Right

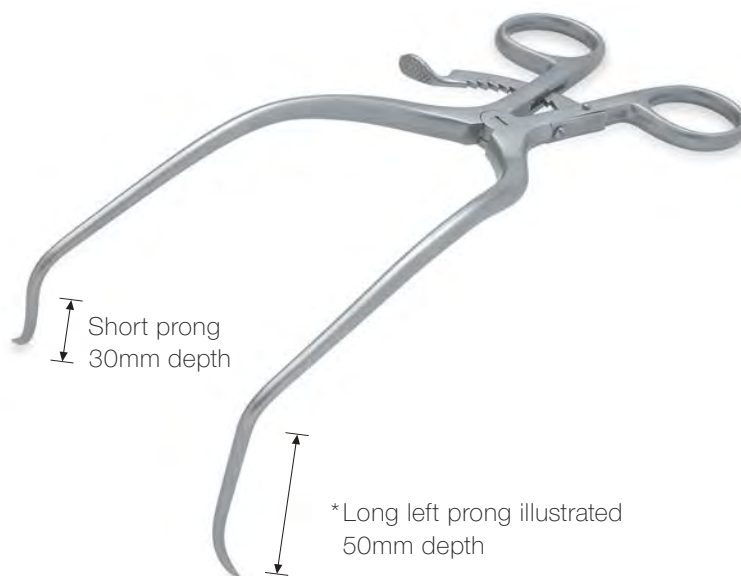

Meyerding Hemi

Laminectomy Retractor
18cm/7"

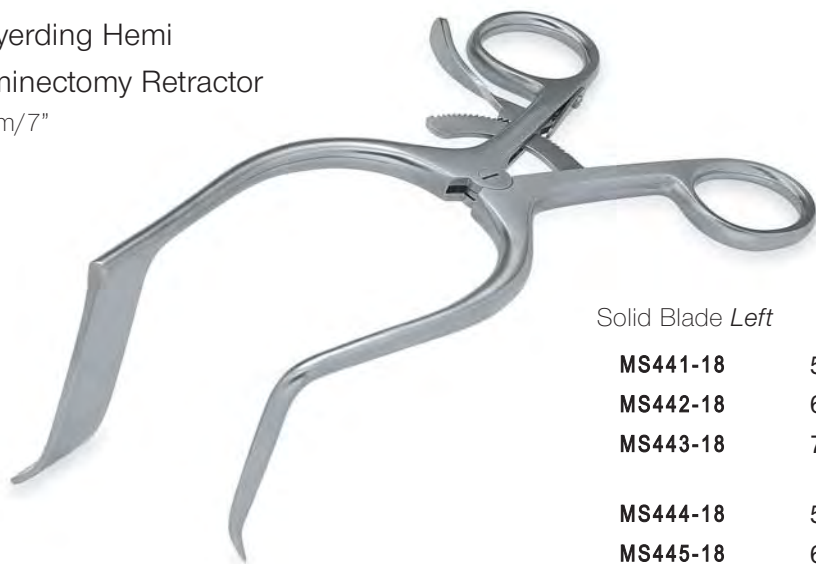

Solid Blade <i>Left</i>	Blade Size	Solid Blade <i>Right</i>	
MS441-18	50 x 10mm	MS447-18	Narrow Blade
MS442-18	60 x 10mm	MS448-18	
MS443-18	70 x 10mm	MS449-18	
MS444-18	50 x 20mm	MS450-18	Wide Blade
MS445-18	60 x 20mm	MS451-18	
MS446-18	70 x 20mm	MS452-18	



SELF RETAINING RETRACTORS

West's Retractor

14cm/5 1/2"

3 x 4 Sharp Prongs

MS453-14



Weitlaner Retractor

14cm/5 1/2"

3 x 4 Blunt Prongs

MS454-14

*West Retractor illustrated

Travers Retractor

4 x 5 Blunt Prongs

20cm/8"

MS455-20

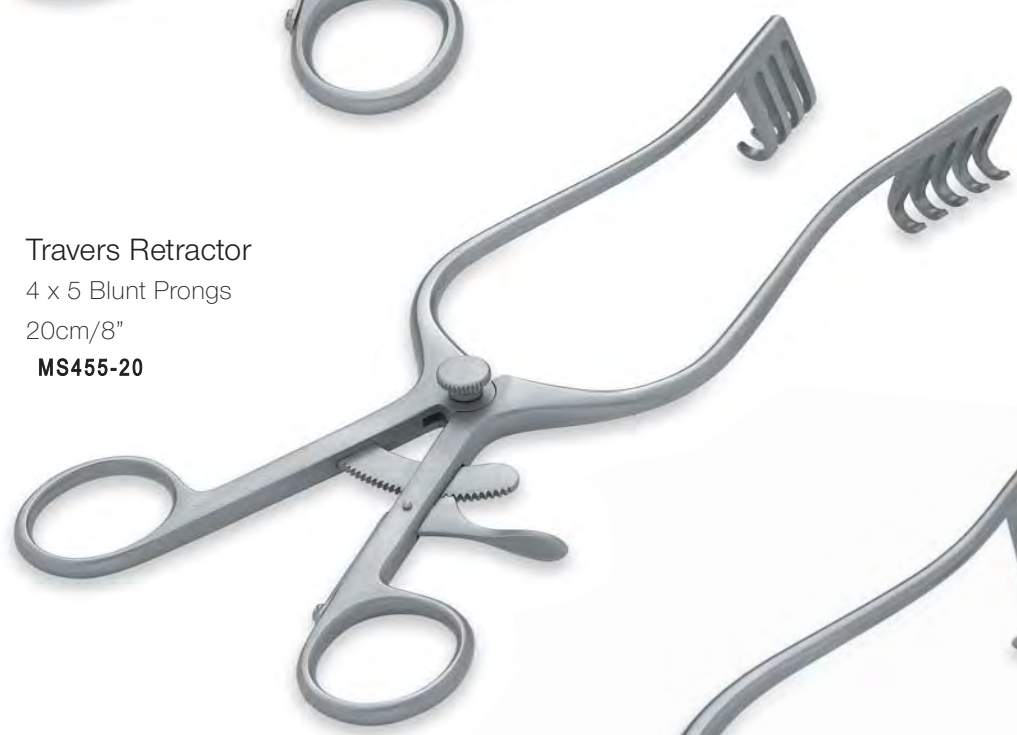

Norfolk and Norwich Retractor

4 x 5 Blunt Prongs

20cm/8"

MS456-20

Cones Self Retaining Retractor
3 x 4 Prongs/Jointed Arms

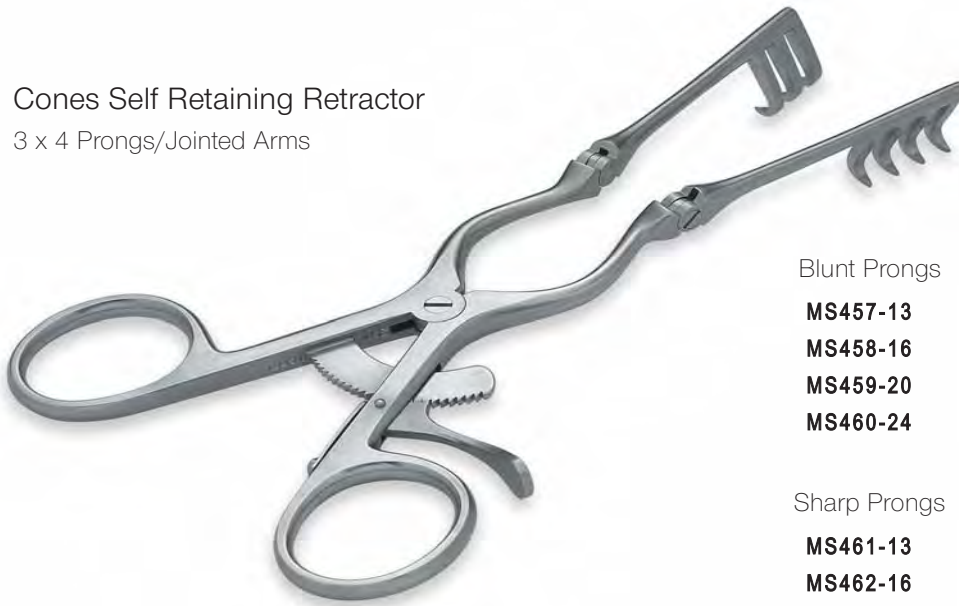

Blunt Prongs	Length
MS457-13	13cm/5"
MS458-16	16cm/6½"
MS459-20	20mm/8"
MS460-24	24mm/9½"

Sharp Prongs	Length
MS461-13	13cm/5"
MS462-16	16cm/6½"
MS463-20	20mm/8"
MS464-24	24mm/9½"

Beckman - Adson Retractor
4 x 5 Blunt Prongs/Jointed Arms
31cm/12"

MS465-32 32mm Deep blades

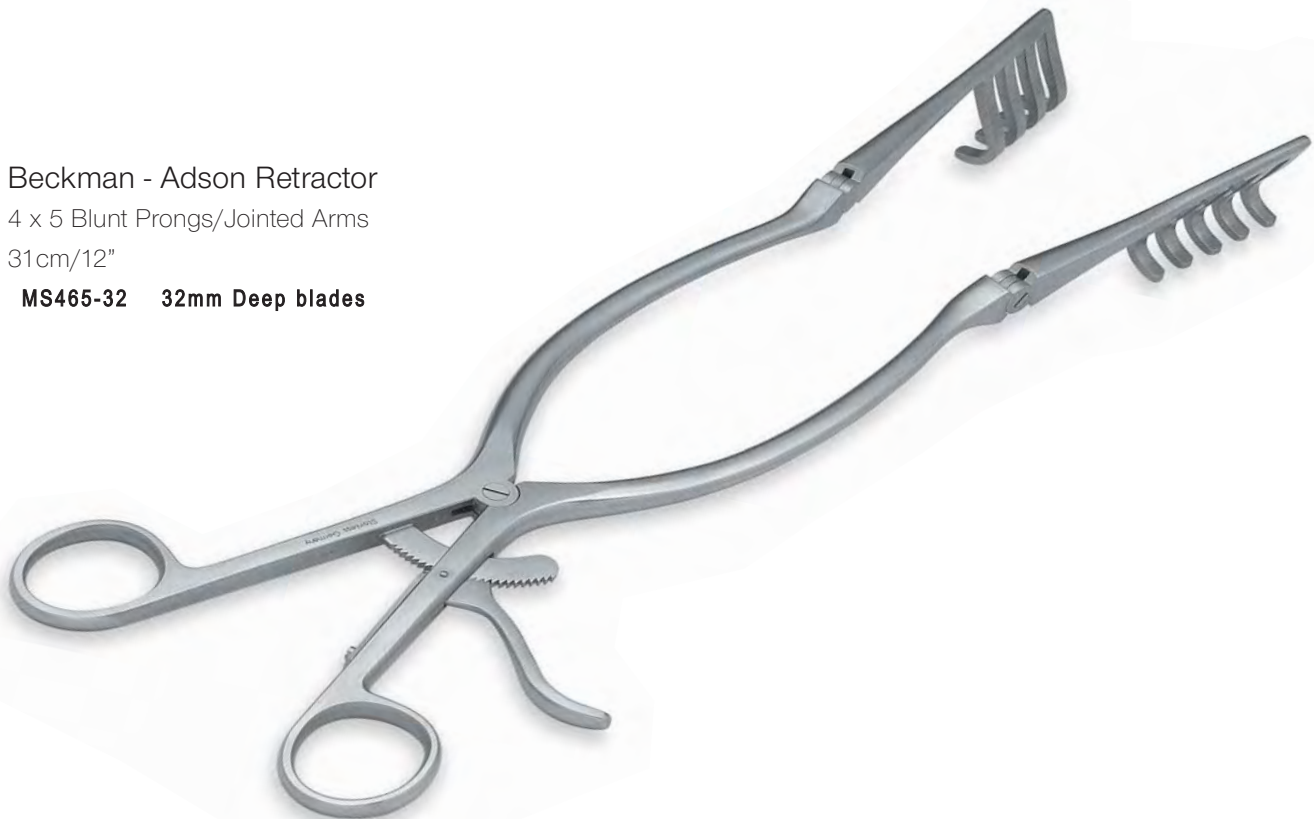



SELF RETAINING RETRACTORS

Viper Scoliosis Retractor
30cm/11³/₄"
Sharp Prongs

	Depth Prongs
MS466-38	40mm
MS467-40	70mm
MS468-50	100mm

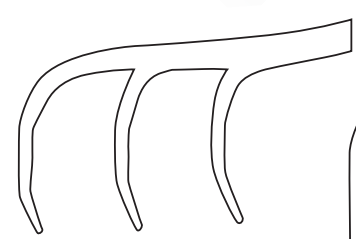

40mm prong depth

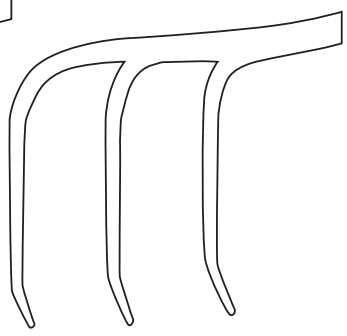

70mm prong depth

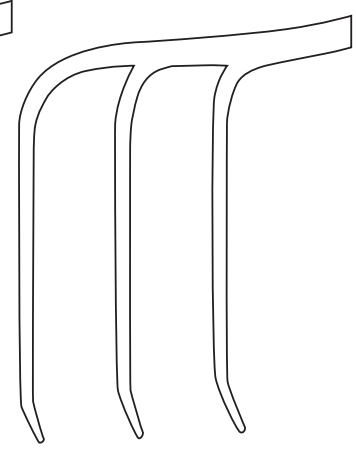

100mm prong depth

Love Bayonet Nerve Root Retractor

21cm/8¹/₄"**MS469-21**

Krayenbuhl Nerve Root Retractor

Double bayonet

21cm/8¹/₄"**MS471-21**

Krayenbuhl Nerve Root Retractor

Double bayonet

24cm/9¹/₂"**MS472-24**

O'Connell Nerve Root Retractor

21.5cm/8¹/₂"**MS473-21**



NERVE ROOT RETRACTORS

Love Nerve Root Retractor

22cm/8³/₄"

5mm tip width



- MS475-22** Straight
- MS476-22** 25° Angled
- MS477-22** 90° Angled

Nerve Root Retractor

with suction

31cm/12"

7mm tip width



MS478-31

Hess Nerve Root Retractor

19cm/7¹/₂"

Width

- MS479-19** 3mm
- MS480-19** 4mm
- MS481-19** 5mm
- MS482-19** 7mm

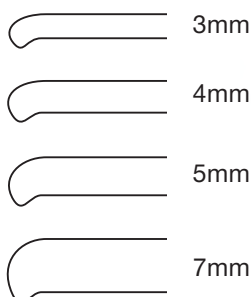

Nerve Root Retractor

19cm/7¹/₂"

with fibre optic illumination

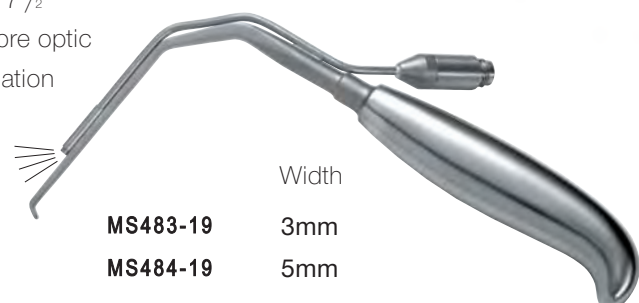

- MS483-19** 3mm
- MS484-19** 5mm

Width



- Bayonet handled design for improved visualisation
- 360° rotating shafts are interchangeable
- Shaft length is adjustable
- Lightweight handle
- Instrument length: 23cm max. for standard curettes
- Shaft length 10cm

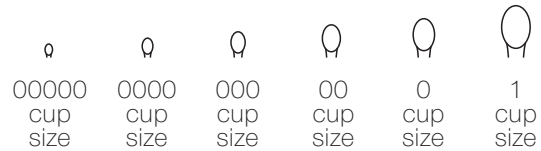

Shaft Sizes

Straight Tip	Cup Size	Forward Angle Tip	Cup Size	Down Pushing Tip	Cup Size
MS486-50	00000	MS491-50	00000	MS496-20	00
MS487-40	0000	MS492-40	0000	MS497-10	0
MS488-30	000	MS493-30	000		
MS489-20	00	MS494-20	00		
MS490-10	0	MS495-10	0		

SPINAL CURETTES

Lempert Curette

21cm/8 1/4"



Straight	Cup Size	Angled	Cup Size
MS498-21	00000	MS504-21	00000
MS499-21	0000	MS505-21	0000
MS500-21	000	MS506-21	000
MS501-21	00	MS507-21	00
MS502-21	0	MS508-21	0
MS503-21	1	MS509-21	1

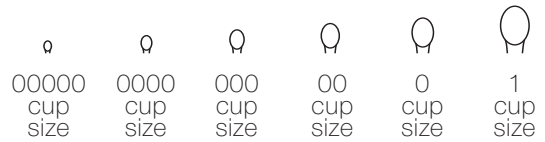

Bruns Curette

23cm/9"



Straight	Cup Size	Angled	Cup Size
MS510-23	000	MS516-23	000
MS511-23	00	MS517-23	00
MS512-23	0	MS518-23	0
MS513-23	1	MS519-23	1
MS514-23	2	MS520-23	2
MS515-23	3	MS521-23	3

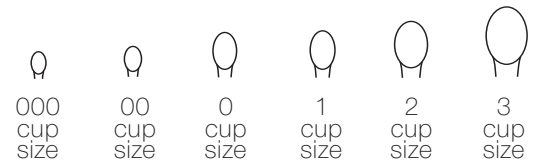

Comfort Handle Curette

20cm Handle

29cm/11 1/2"



Straight	Cup Size	Angled	Cup Size
MS522-07	6.5mm	MS527-07	6.5mm
MS523-09	8.5mm	MS528-09	8.5mm
MS524-11	11mm	MS529-11	11mm
MS525-13	13mm	MS530-13	13mm
MS526-15	15mm	MS531-15	15mm

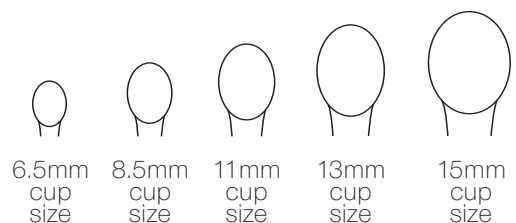

Tufnol Handle Curette

27cm/10"

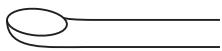

Straight Cup Size

Angled Cup Size

- MS532-27** 2mm
- MS533-27** 3mm
- MS534-27** 4mm
- MS535-27** 5mm

- MS536-27** 2mm
- MS537-27** 3mm
- MS538-27** 4mm
- MS539-27** 5mm

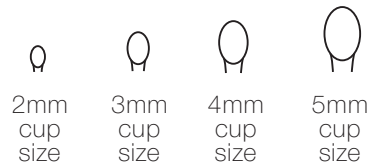

Long Anterior Curette

38cm/15"

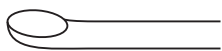

Straight Cup Size

Angled Cup Size

- MS540-38** 4.3mm
- MS541-38** 7mm
- MS542-38** 8mm

- MS543-38** 4.3mm
- MS544-38** 7mm
- MS545-38** 8mm

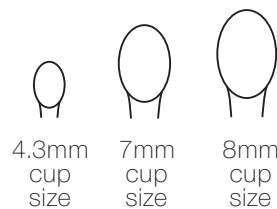





SPINAL CURETTES

Cones Ring Curette
23cm/9"



Straight	Ring Size	Angled	Ring Size		
MS546-23	3mm	MS549-23	3mm		3mm ring size
MS547-23	6mm	MS550-23	6mm		6mm ring size
MS548-23	8mm	MS551-23	8mm		8mm ring size







Zielke Curette
21cm/8 1/4"



Straight	Size	Angled	Size
MS552-21	8mm	MS554-21	8mm
MS553-21	11mm	MS555-21	11mm

Volkman Double Ended Curette
22cm/8 3/4"









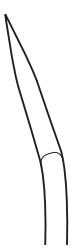

	Size			
MS556-22	Small			
MS557-22	Medium			
MS558-22	Large	Small	Medium	Large

Dahmen Tufnol Handle Osteotome

30cm/12"







	5mm		Straight	Width		Angled	Width
	10mm		MS559-30	5mm		MS565-30	5mm
	15mm		MS560-30	10mm		MS566-30	10mm
	20mm		MS561-30	15mm		MS567-30	15mm
	25mm		MS562-30	20mm		MS568-30	20mm
	30mm		MS563-30	25mm		MS569-30	25mm
			MS564-30	30mm		MS570-30	30mm

Lexer Tufnol Handle Osteotome

22cm/8³/₄"



	7mm		Width	
	10mm		MS571-22	7mm
	15mm		MS572-22	10mm
	20mm		MS573-22	15mm
	25mm		MS574-22	20mm
		MS575-22	25mm	

Stille Osteotome

20cm/8"



	6mm		Width	
	8mm		MS576-20	6mm
	10mm		MS577-20	8mm
	12mm		MS578-20	10mm
	15mm		MS579-20	12mm
	20mm		MS580-20	15mm
	25mm		MS581-20	20mm
	30mm		MS582-20	25mm
		MS583-20	30mm	

OSTEOTOMES & MALLETS

Scaglietti Straight Osteotome Set

MS584-00

Complete set consisting of:

Qty	Order Code	Description
5	MS585-90	Scaglietti Osteotomes - 5 sizes
1		Instrument Case



Scaglietti Osteotomes

26cm/10¹/₄"

	Size
MS586-06	6mm
MS587-09	9mm
MS588-12	12mm
MS589-16	16mm
MS590-19	19mm



Ombredanne Mallet

24cm/9¹/₂"

Head size 40mm Ø

Weight 550g/20oz

MS591-24



London Splint Mallet

18cm/7"

Head size 30mm Ø

Weight 450g/16.2oz

MS592-18



Lumbar Bone Graft Impactor

22cm/8½"



7mm x 12mm
MS593-40



10mm x 13mm
MS594-50



Cervical Bone Graft Impactor 90° Offset

22cm/8½"

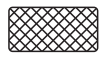

6mm x 12mm Tip
MS595-10

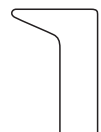

3.5mm x 6mm Tip
MS596-55
18cm length

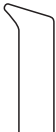

Anterior Bone Graft Impactor

34cm/13½"



9 x 16mm Tip
MS597-48

9 x 23mm Tip
MS598-50

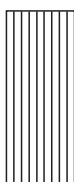
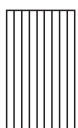



DISSECTORS

Swedish Dissector

18cm/7"



MS599-18

Howarth Elevator

21.5cm/8½"



MS600-21

MacDonald Elevator/Dissector



Size

MS601-19 18cm/7"

MS602-23 23cm/9"

Watson Cheyne Dissector



Size

MS603-18 18cm/7"

MS604-23 23cm/9"

MS605-25 25.5cm/10"

Freers Elevator/Dissector

18.5cm/7¼"



MS606-18

Adson Dural Hook

19cm/7½"

Sharp
MS607-19

Blunt
MS608-19



Emmet Sharp Hook

22cm/8¾"

5mm tip length



MS609-22

Cushing Blunt Hook

28cm/11"

4mm tip length



MS610-28

Crile Blunt Hook

20cm/8"

7mm tip length



MS611-20

Caspar Exploration Hook Insulated

24.5cm/9¾"



MS612-24



MS613-24

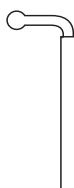

MS614-24



MS615-24

HOOKS & PROBES

Adson Blunt Hook

20cm/8"

5mm tip length



MS616-20

Adson Sharp Hook

20cm/8"

5mm tip length



MS617-20

Hook with Ball End

23.5cm/9¹/₄"

5mm tip length



MS618-13

Manipulation Hook

23.5cm/9¹/₄"

4mm tip length



MS619-15

Blalock Blunt Hook

24cm/9¹/₂"

5mm tip length



MS620-24

Cobbs Spinal Elevator

31cm/12¹/₄" overall length/18cm/7" handle length



10mm
MS621-10

13mm
MS622-13

19mm
MS623-19



Comfort Cobbs Elevator

32cm/12¹/₂" overall length/20cm/8" handle length



10mm
MS624-10

15mm
MS625-15

20mm
MS626-20

25mm
MS627-25

30mm
MS628-30

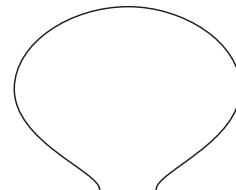
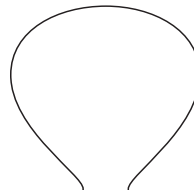
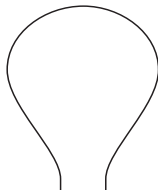

Long Anterior Comfort Cobbs Elevator

47cm/18¹/₂"



10mm
MS629-50

15mm
MS630-55

20mm
MS631-60

25mm
MS632-65

30mm
MS633-70

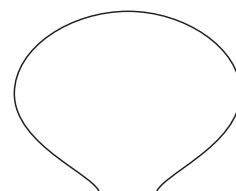
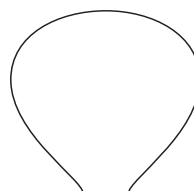
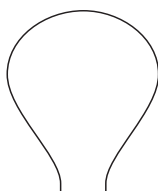



ELEVATORS & GOUGES

Adson Periosteal Elevator

16cm/6 1/4"

Curved blunt



	Width		Width
MS634-16	5mm	MS635-16	7mm

Pennybacker Periosteal Elevator

16cm/6 1/4"

Curved sharp



	Width
MS636-16	6mm

Bone Raspatory with Tufnol Handle

19cm/7 1/2"

Straight

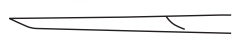
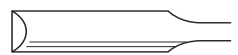

	6mm	
MS637-19		

Bone Raspatory with Tufnol Handle

19cm/7 1/2"

Curved



	3mm			6mm	
MS638-19			MS639-19		

Farabeuf Rugine Elevator

15cm/6"



	Width		Width
Straight		Curved	
MS640-15	12mm	MS641-15	12mm

Bristows Elevator

23cm/9"

Curved sharp



	Width
MS642-23	10mm

Trethowan Bone Lever

22.5cm/8¹/₂"



MS643-22

Lanes Bone Lever

26cm/10¹/₄"



MS644-26

Fagge Bone Lever

27.5cm/10³/₄"



MS645-27

Hohmanns Bone Elevator

24cm/9¹/₄"



	Width
MS646-24	8mm
MS647-24	18mm
MS648-24	43mm



ELEVATORS & GOUGES

Zielke Gouge Curved
23cm/9"



	Width
MS649-23	6mm
MS650-23	9mm

Zielke S-Shaped Gouge
23cm/9"



	Width
MS651-23	6mm
MS652-23	9mm

Capener Lamina Gouge
Cranked Shaft
23cm/9"



	Width
MS653-23	6mm
MS654-23	8mm
MS655-23	11mm
MS656-23	16mm

Cobb Gouge
28cm/11"



	Width		Width
MS657-28	8mm	MS658-28	8mm

Measuring Caliper

25cm/10"

MS659-20

Castroviejo Caliper

7cm/2³/₄"

Measuring range 3mm to 25mm

MS660-10

Vernier Caliper

22.5cm/9"

Measuring
range 15cm**MS661-00**

MISC INSTRUMENTS

Frazier Suction Tube
17cm/6³/₄"



		Width
MS662-17	6FG	2.0mm
MS663-17	7FG	2.3mm
MS664-17	8FG	2.7mm
MS665-17	9FG	3.0mm
MS666-17	10FG	3.3mm
MS667-17	12FG	4.0mm

Frazier Suction Tube
23cm/9"



		Width
MS668-23	6FG	2.0mm
MS669-23	7FG	2.3mm
MS670-23	8FG	2.7mm
MS671-23	9FG	3.0mm
MS672-23	10FG	3.3mm
MS673-23	12FG	4.0mm

Bayonet Dissecting Forceps



19cm/7 ¹ / ₂	Tip Size	21cm/8 ¹ / ₄	Tip Size
MS674-19	1mm	MS676-21	1mm
MS675-19	2mm	MS677-21	2mm

Bayonet Bipolar Forceps
(European Block ended fitting)



19cm/7½" Tip Size

- MS678-80** 0.3mm
- MS679-83** 0.7mm
- MS680-81** 1.0mm
- MS681-82** 2.0mm

Bipolar Cable



MS685-35L

Banana Plug machine fitting

22.5cm/9" Tip Size

- MS682-90** 0.3mm
- MS683-91** 0.7mm
- MS684-92** 1.2mm



MS686-30L

Erbe, Storz or Select fitting BM50



MS687-38L

Select fitting BM780

Bayonet Bipolar Forceps
With anti-stick tips
(two pin USA fitting)



22.5cm/8¾" Tip Size

- MS688-300** 0.5mm
- MS689-320** 0.7mm
- MS690-340** 1.0mm
- MS691-350** 1.3mm
- MS692-360** 1.5mm
- MS693-380** 2.0mm

Bipolar Cable



MS694

Banana Plug fitting



MISC INSTRUMENTS

Bolt Cutters with dismantable arms

max. cap 6.5mm pins
57cm length

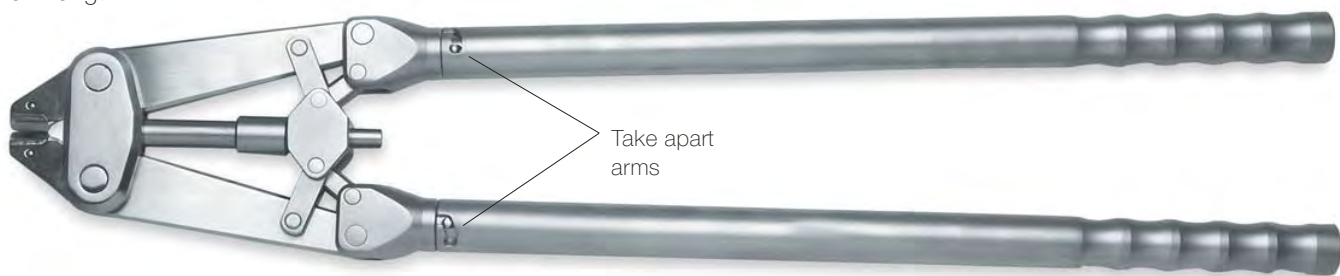

MS695-575

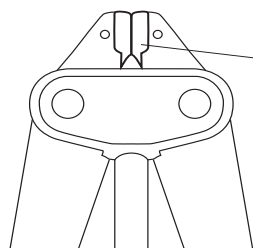

Soft silicon pads positioned above jaws prevent cut pin from causing injury.

- Dismantable Arms for easier sterilization
- Exchangeable Jaws
- New lighter cutting action

Muller-Claus Wire Cutters

Tungsten Carbide Jaws

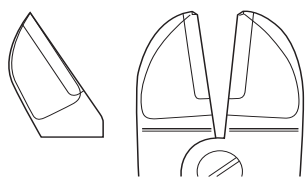

Length

- | | | |
|------------------|---|---|
| MS696-E18 | 18cm/7" | • Suitable for wires up to 2mm diameter |
| MS697-E22 | 22cm/8³/₄" | • Suitable for wires up to 3mm diameter |

Needle Nosed Locking Pliers



Length

- | | | | |
|------------------|--|--------|---|
| MS698-220 | 22cm/8³/₄" | Small | • A very useful instrument for orthopaedic surgery allowing the surgeon to securely clamp on to wires and implants. |
| MS699-250 | 25cm/9³/₄" | Medium | |
| MS700-300 | 30cm/11³/₄" | Large | |

Jointed Arms



Retractor Frame with Jointed arms
MS701-00

Wide Muscle Blades

Dimensions



- MS701-03** 3cm depth
- MS702-04** 4cm depth
- MS703-05** 5cm depth
- MS704-06** 6cm depth
- MS705-07** 7cm depth
- MS706-08** 8cm depth

Hook Blades

Dimensions



- MS707-02** 2cm depth
- MS708-03** 3cm depth
- MS709-04** 4cm depth
- MS710-05** 5cm depth
- MS711-06** 6cm depth
- MS712-07** 7cm depth

Narrow Muscle Blades

Dimensions



- MS713-03** 3cm depth
- MS714-04** 4cm depth
- MS715-05** 5cm depth
- MS716-06** 6cm depth
- MS717-07** 7cm depth
- MS718-08** 8cm depth

Toothed Blades

Dimensions



- MS719-02** 2cm depth
- MS720-03** 3cm depth
- MS721-04** 4cm depth
- MS722-05** 5cm depth
- MS723-06** 6cm depth
- MS724-07** 7cm depth

'BLACK BELT' ADVANCED CERVICAL RETRACTOR SET



- Full jointed retractor arms
- Black non-glare finish
- Wide blade range
- Suitable for single or multi level retraction

Blades

- The blade shape is designed to resist climbing out of the surgical site
- The wider two level blades have an extra bend near the tip which follows the contour of the vertebrae for visualising



27mm wide two level pronged blade

27mm wide two level blade

Pronged blade

Blunt blade



Blade Inserter Clamp

- Spring loaded clamping jaws for easy blade engagement
- Clamp handles create minimal visual obstruction
- Blade/clamp assembly may be used for hand retraction
- Clamps are quickly/easily removed after retractor arms have securely engaged the blades

Lumbar Micro Discectomy Attachments

With this set the standard Cervical Retractor becomes a Lumbar Microdiscectomy Retractor unit.

MS725-00

Complete set consisting of:

Qty	Order Code	Description
1	MS726-10	Micro Disc attachment
1	MS727-20	Spike Blade
1	MS728-30	T-Shape Blade
1	MS729-40	Inner Spine Ligament Blade
1	MS730-85	Pronged Blade 85mm depth

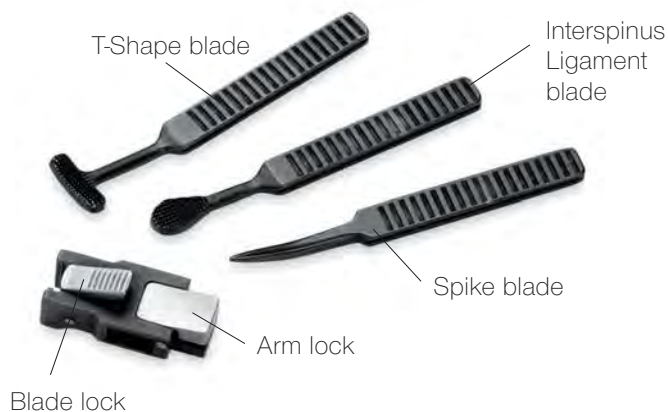

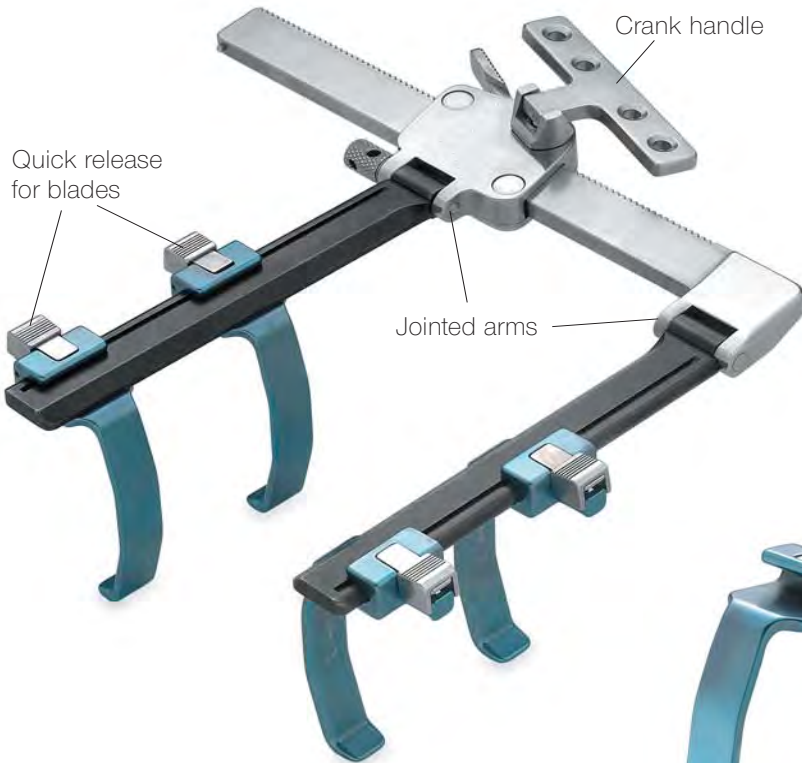

Super-Slide Retractor Blades

- Will not slip out of wound during surgery
- Narrow blade design minimizes potential of tissue necrosis at blade and tissue contact point
- Blades feature quick release locking system

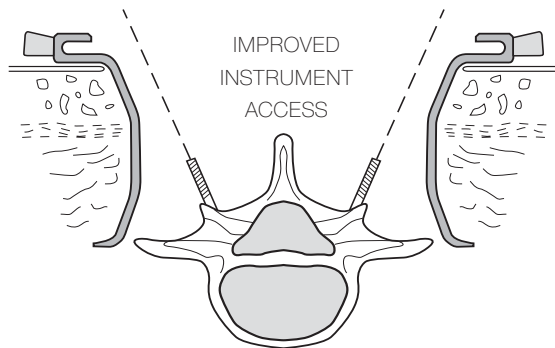

Unilateral Blade Attachment

- Blades lock into any chosen position along the retractor arms and may be changed at any time during surgery
- Arm locks allow the surgeon the choice of either attaching to the retractor arms then placing the unit into the wound or placing the blades into the wound then engaging the frame arms
- To obtain a unilateral exposure, use the unilateral blade attachments contained in the extended set. The T-Blade is designed to attain a firm purchase on the Spinousprocess
- The T-Blade can be adjusted to the correct depth with the blade lock

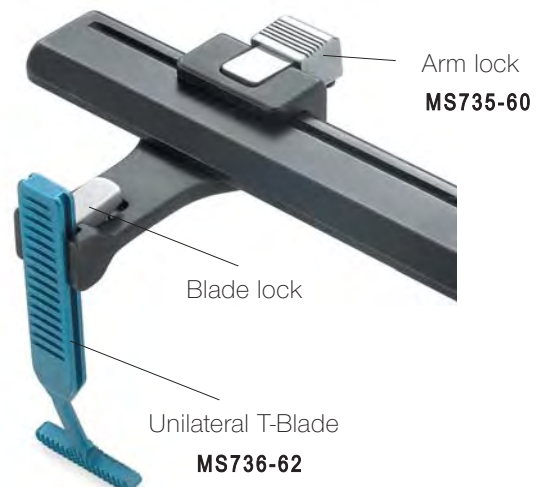



CASPAR MICRO LUMBAR DISCECTOMY RETRACTOR



Caspar Micro Discectomy Retractor

- This Retractor Set allows a micro surgery approach to Lumbar Disc
- Specula have a black surface finish to prevent glare
- Fenestrated blades on the specula reduce the risk of movement during surgery

Complete Set

MS800-00

Consisting of:

Lateral Blades	Depth	Specula	Depth
MS801-40	40mm	MS808-40	40mm
MS802-45	45mm	MS809-45	45mm
MS803-50	50mm	MS810-50	50mm
MS804-55	55mm	MS811-55	55mm
MS805-60	60mm	MS812-60	60mm
MS806-65	65mm	MS813-65	65mm
MS807-70	70mm	MS814-70	70mm



MS815-00 Counter Retractor Frame
 MS816-00 Blade Ejector Forceps

Lateral Blades



Blade Ejector Forceps

MS817-00



Specula Range



Caspar Micro Discectomy Retractor Frame

MS818-00



BLACK BELT MICRO DISCECTOMY RETRACTOR SET

Black Belt Micro Discectomy Retractor Set

A specialist retractor for Lumbar Micro Discectomy Surgery featuring:

- Jointed retractor arms
- Adjustable blade depth
- Range of pronged blades
- Powerful ratchet action with quick release mechanism

MS7274-00 Complete Set

Complete set consisting of:

Qty	Order Code	Description
1	MS7274-10	Retractor Frame
1	MS7274-15	Blade Inserting Clamp
1	MS7274-20	Spike Blade
1	MS7274-30	T-Shape Blade
1	MS7274-35	Inner Spine - Ligament Blade
1	MS7274-40	Pronged Blade 40mm
1	MS7274-45	Pronged Blade 45mm
1	7MS274-50	Pronged Blade 50mm
1	MS7274-60	Pronged Blade 60mm
1	MS7274-70	Pronged Blade 70mm
1	MS7274-85	Pronged Blade 85mm
1	MS7274-90	Sterilising Container

