



**SURTEX**  
INSTRUMENTS

*Crafted to Excellence*







# SURTEX INSTRUMENTS

*Crafted to Excellence*

### • INTRODUCTION TO THE CATALOGUE

In this catalogue we are pleased to introduce the general surgical instruments range available from Surtex Instruments. Following feedback from customers we have prepared this as a standalone catalogue to allow for quick referencing and searching of our products required on a routine basis. The specialist ranges of our instruments are covered in the following additional catalogues available upon request.

- ENT
- Cardiovascular & Neurosurgery
- Ophthalmic
- Gynaecology and Obstetrics
- Dental Instruments
- Sterilization & Holloware

### • ABOUT SURTEX INSTRUMENTS

**Surtex Instruments** is a privately owned medical technology company dedicated to innovation and excellence in crafting of surgical instruments. The company started as a specialist in reconstructive surgery instruments and based on its success and innovative drive gradually expanded to cover a vast range of surgical instruments.

We now manufacture over 8,000 surgical instruments and offer innovative solutions in trauma, gynecology, cardiovascular, microsurgery and dental surgery. All our products are available to view online where you can download our entire range of catalogues or request a printed version.

### • SURTEX QUALITY STANDARDS

In European Union medical devices are subject to a series of uniform laws and the EC directive places rigid demands on surgical instruments. Surtex Instruments is proud to claim that we have always surpassed the legal requirements to ensure that each instrument reaching the surgeons hand is indeed a testament to surgical craftsmanship.

We are **BS EN ISO 13485:2012/ISO 9001:2008 (SGS UK)** certified and **CE** approved to ensure compliance with the standards defined in line with medical devices directive **93/42/EEC**.



### WHY IS SURTEX FOCUSED ON INSTRUMENTS QUALITY?

Surgeons are highly talented and skilled individuals. They operate under significant time constraints and are required to make split second decisions while performing complex operations. At Surtex we understand that in such a scenario the surgeon requires tools that are not just fit for the purpose but are reliable, dependable and crafted by a company that has a track record for relentless pursuit for excellence in the making of surgical instruments.



### • AFFORDABLE QUALITY

Surgical instruments represent a significant proportion of hospital's total assets. Hospitals and health centers are often required to minimize costs of surgical instruments without impacting quality or patient's health. Decision makers tend to respond via group purchasing contracts & multiple quotes to shop around for the lowest price. However this approach has significant drawbacks as numerous instrument companies have focused towards competing on price alone with a disregard towards instruments quality while claiming their instruments to be guaranteed and free of defect.

The outcome for the buyer being a perceived notion of a quality instrument, which is actually little more than a knock-off and delivers only poor value for money.

At **Surtex Instruments** our success has been based on helping customers navigate successfully through the instrument procurement process by identifying real value for money through fair comparison. We believe that quality should be affordable and you should not pay too much for over priced brands and neither should you pay too much for a low quality instrument.

### • LIFE TIME WARRANTY

We encourage our customers to calculate lifetime costs prior to making purchase decisions and investing in surgical instruments.

**Surtex Instruments** are guaranteed for life\* against manufacturing defects of material and workmanship. This means we will repair or replace free of charge any surgical instrument that does not meet its functional requirements when used for its intended purpose and maintained properly.



\*Conditions apply.





**SURTEX**  
INSTRUMENTS

*Crafted to Excellence*

## OUR PRODUCT BRANDS



A new dimension in cutting and dissecting performance. Our class leading integral self-sharpening technology standard on all Surtex scissors enabling precise cutting with minimum force even after pro-longed use.



These Surtex premium scissors feature finely ground micro serrations along one blade of the scissor preventing tissue slippage. The ultra sharp edge of the other blade cuts through the tissue precisely and atraumatically.



Instruments with this symbol benefit from tungsten carbide (TC) inserts expertly bonded on the cutting edge of the instrument. This material is harder than stainless steel and enables the instruments to last up to 6 times longer than standard instruments.



A true craftsmanship masterpiece and surgeons favourite. These are the best scissors in our range and combine the features of SuperEdge™ & UltraCut™ into a perfect pair of scissors that is precise, durable and reliable.



The only choice when the perfect grip matters. Utilising Creep Feed technology individual teeth are grinded into hard wear resistant tungsten carbide (TC). The result is super sharp teeth with well-defined point and inserts with impeccable gripping properties and instruments that last up to 6 times longer.



These instruments have jaws, which are coated with diamond dust resulting in improved gripping enabling superior manipulation of sutures, needles and tissues.



Our specially designed high strength fibre grip handles resulting in lightweight instruments. These ergonomic handles provide the surgeon with excellent feel, better grip, reduced shock, and less hand fatigue.



Surtex ENT diagnostic and anaesthesia instruments featuring direct bulb illumination of xenon grade bulbs.



This range features distal fibre optic to carry light from xenon bulb allowing cold illumination on operating site in our ENT diagnostics and anaesthesia instruments.



Premium grade ENT diagnostics and anaesthesia instruments combining features of distal fibre optic technology and ultra bright LED illumination ensuring the best in clear vision of operating site.



## CURRENT REFERENCE STANDARDS FOR SURTEX PRODUCTS

STANDARDS	CONTENTS OF THE STANDARD
BS EN ISO 9001:2008	Quality Management Systems certification standard.
BS EN ISO 13485:2003	Medical Devices – Quality Management Systems certification standard.
MDD 93/42/EEC, Annex II, Section 3.2	Medical Device Directive, 'EC Declaration of Conformity' (full quality assurance system).
MDD 93/42/EEC, Annex I	Essential Requirements for Medical Devices.
BS EN ISO 7153-1:2001 (BS 5194:Part 1:1991)	Surgical Instruments – Metallic materials part 1 - Stainless Steel
BS 5194:Part 2:1989	Specification for instruments with pivot joints (excluding cutting instruments)
BS 5194:Part 3:1985	Specification for Dissecting Forceps
BS 5194:Part 4:1985	Specification for scissors, shears, and other jointed cutting instruments
ISO 7151:1988	Surgical instruments – non-cutting, articulated instruments – general requirements & test methods
ISO 7740:2004	Scalpels with detachable blades - Fitting dimensions
ISO 7741:1986	Scissors and shears - General requirements and test methods
ISO 6508-1:2005 (DIN 50103-3:1995)	Specifies the method for Rockwell and Rockwell superficial hardness tests for metallic materials.
BS EN ISO 14971:2012	Medical Devices – Application of risk management to medical devices.
DIN 58298:2010-09	Medical instruments - Materials, finish and testing.
DIN 58299:1964-01	Serrations for surgical instruments; profile angles, groove distances.
DIN 58300:1982-02	Joints for surgical instruments.
HTM 2010	Recommendations for sterilization
AS/NZ 4187-2003	Cleaning, disinfecting & sterilising of re-usable surgical instruments

This information is available on the internet at  
[www.surtex-instruments.co.uk](http://www.surtex-instruments.co.uk)



## INSTRUCTIONS FOR REPROCESSING OF REUSABLE SURGICAL INSTRUMENTS

The following instructions are for all reusable medical devices supplied by Surtex Instruments Ltd, unless stated otherwise with the packaging of the product. These instructions are intended for use only by persons with the required specialist knowledge and training.

### Warnings

- Follow instructions and warnings as issued by the manufacturers of any decontaminants, disinfectants and cleaning agents. Wherever possible avoid use of mineral acids and harsh, abrasive agents.
- No part of the process shall exceed 140 °C.
- Some sensitive materials (e.g. Aluminium) are damaged by high alkaline solutions (pH>10).
- Devices with long, narrow cannula, hinges and blind holes require particular attention during cleaning.

**Note:** When reprocessing medical devices, always handle with care, wearing protective clothing, gloves and eye-wear in accordance with local health & safety procedures.

### Limitations on Reprocessing

- Repeated processing has minimal effect on these instruments.
- End of life normally determined by wear and damage in use.
- Any specific limitations on the number of reprocessing cycles shall be made available with instrument.

### From Point of Use

Whenever possible, do not allow blood, debris or bodily fluids to dry on instruments. For best results and to prolong the life of the medical device reprocess immediately after use. If they cannot be reprocessed immediately, use an enzymatic foam spray cleaner to help prevent soil from drying.

### Preparation for Decontamination

- Process all the instruments as soon as it is reasonably practical following use.
- Disassemble only where intended, without the use of tools unless specifically provided by the manufacturer. Instructions for dis assembly are available with the device, where required.

### Cleaning: Automated

- Use only either CE marked or validated washer-disinfector machines and low foaming, non-ionizing cleaning agents and detergents following the manufacturer's instructions for use, warnings, concentrations and recommended cycles.
- Load instruments carefully, with any box joints and hinges open and so that any fenestration in instruments can drain.
- Place heavy instruments with care in the bottom of containers, taking care not to overload wash baskets.
- Place instruments with concave surfaces facing down to prevent pooling of water.
- Where possible, use appropriate attachments to flush inside reamers and devices with lumens or cannula.
- Ensure that soft, high purity water which is controlled for bacterial endo-toxins is used in the final rinse stage.

**Note:** Automated cleaning may not be suitable for all lumens and cannula in which case clean manually with a water jet gun, if available, and an appropriate brush (and stilette if provided) that reaches the depth of the feature. After manually cleaning, pass all devices through an automatic cleaning cycle to achieve disinfection.

**Note:** These instruments have been validated using a washer-disinfector cycle validated to include two cold rinses at <35 °C, a detergent cycle and a rinse cycle both at >50°C, a disinfection cycle operating at a temperature of between 80 °C and 90 °C for a minimum holding time of 1 minute (actual holding time in excess of 2 minutes 50 seconds) and a 20 minute drying cycle. The detergent used was low foaming, non-ionizing spray wash detergent cleaner (max 12pH) and the rinse aid a neutral pH low foaming, non-ionic surfactant with isopropyl alcohol.

### Cleaning: Manual

- Manual cleaning is not advised if an automatic washer-disinfector is available. If the equipment is not available, use the following process:-

1. Use a double sink system (wash/rinse) dedicated for instrument cleaning (not used for hand washing). Ensure that the water temperature does not exceed 35 of the re-processor to ensure that the reprocessing as actually performed using equipment, materials and personnel in the reprocessing facility achieve the desired result. This requires validation and routine monitoring of the process. Likewise any deviation by the re-processor from the instructions provided must be properly evaluated for effectiveness and potential adverse consequences.
2. In the first sink, keeping the instrument submerged, with an autoclavable brush, apply CE marked cleaning solution to all surfaces until all soil has been removed. Pay particular attention to serrations, teeth, ratchets and hinges, always brushing away from the body and avoiding splashing. Ensure rongeurs and hinged instruments are thoroughly cleaned in both open and closed positions.
3. In the second sink, rinse instruments thoroughly with soft, high purity water which is controlled for bacterial endotoxins, so that the water reaches all parts of the instrument, then carefully hand dry or use a drying cabinet.

**Note:** Manual Cleaning is NOT a disinfection process: When manual cleaning is used it may not be possible to disinfect the device prior to further handling.

### Cleaning Inspection

- After cleaning visually inspect, visually inspect all surfaces, cannulations, ratchets, joints, holes and lumens for complete removal of soil and fluids. If ANY soil or fluid is still visible, return the instrument for repeat decontamination.

### Maintenance

- Apply surgical grade lubricant to hinges, joints and moving parts as per the lubricant manufacturer's instructions.

Continued on next page



### Inspection and Functional Testing

- Visually inspect and check: - all instruments for damage and wear; cutting edges are free from nicks and present a continuous edge; jaws and teeth align correctly; all articulated instruments have a smooth movement without excess play; locking mechanisms (such as ratchets) fasten securely and close easily; long, slender instruments are not distorted; any component parts fit and assemble correctly with mating components.
- Remove for repair and replacement any blunt, worn out, flaking, fractured or damaged instruments.

**Note:** If an instrument is returned to the manufacturer / supplier, the instrument must be decontaminated and sterilized and be accompanied with the relevant documented evidence.

### Packaging

- All instruments to be packed following local protocol in accordance with ISO 11607-1 or AAMI/CSR technique.

### Sterilization (USA)

- Autoclave should comply with the requirements of, and be validated and maintained in accordance with ANSI/AAMI ST79.
- Pre-Vacuum moist heat sterilization operating at temperature 132 °C bar for a minimum holding time of 4 minutes always following the instructions of the machine manufacturer.
- When sterilizing multiple instruments in one autoclave cycle, ensure that the sterilizer manufacturers stated maximum load is not exceeded.
- Ensure instruments are dry before sterilization.

### Sterilization (Outside USA)

- Autoclave should comply with the requirements of, and be validated and maintained in accordance with EN 285, EN 13060, EN ISO 17665.
- Either CE marked or validated vacuum autoclave operating at 134-137 °C bar for a minimum holding time of 3 minutes always following the instructions of the machine manufacturer.
- When sterilizing multiple instruments in one autoclave cycle, ensure that the sterilizer manufacturers stated maximum load is not exceeded.

### Storage

- Ensure instruments are dry before storage, and stored in dry, clean conditions at an ambient room temperature.

### Additional Information

- Other forms of cleaning (i.e. ultrasonic) and sterilization (i.e. Low temperature steam and Formaldehyde, Ethylene Oxide and Gas Plasma) are available. However, always follow the instructions for use as issued by the manufacturer and always consult with them if in any doubt over the suitability of any process used.
- Cleaning and sterilizing guidelines are available in HTM 2030 and HTM 2010. Contact: The NHS Estates Stationers Office Publications Cent for details at [www.tsonline.gov.uk](http://www.tsonline.gov.uk). For further information contact: NHS Estates Information Center, Department of Health, 1 Trevelyan Square, Boar Lane, Leeds, LS1 6AE, UK or visit [www.nhsestates.gov.uk](http://www.nhsestates.gov.uk).

**Note:** It is the responsibility of the re-processor to ensure that the reprocessing as actually performed using equipment, materials and personnel in the reprocessing facility achieve the desired result. This requires validation and routine monitoring of the process. Likewise any deviation by the re-processor from the instructions provided must be properly evaluated for effectiveness and potential adverse consequences.



CODE, PAGE & LOGO GUIDE

Company Name & Logo  
Firmenname und Logo  
Nombre y logotipo de la compañía  
Nom et logo de l'entreprise  
Nome e il logo

**Operating Scissors**  
Straight, Sharp/Blunt

Catalog #	Size
SS-004-13 SC	13 cm (5")
SS-004-14 SC	14.5 cm (5 ¾")

**Operating Scissors**  
Curved, Sharp/Blunt

Catalog #	Size
SS-005-11	12 cm (4 ¾")
SS-005-13	13 cm (5")
SS-005-14	14.5 cm (5 ¾")
SS-005-16	16.5 cm (6 ½")
SS-005-18	18.5 cm (7 ¼")
SS-005-20	20.5 cm (8")

**Operating Scissors**  
Curved, Sharp/Blunt

Catalog #	Size
SS-005-13 SC	13 cm (5")
SS-005-14 SC	14.5 cm (5 ¾")

**Operating Scissors**  
Straight, Sharp/Sharp

Catalog #	Size
SS-006-11	12 cm (4 ¾")
SS-006-13	13 cm (5")
SS-006-14	14.5 cm (5 ¾")
SS-006-16	16.5 cm (6 ½")
SS-006-18	18.5 cm (7 ¼")
SS-006-20	20.5 cm (8")

Operating Scissors  
Chirurgische Scheren  
Tijeras quirúrgicas  
Ciseaux chirurgicaux  
Forbici per chirurgia

Product Sub Group  
Produkt-Untergruppe  
Producto Sub Grupo  
Produit Sous-groupe  
Prodotto Sub Gruppo

Product Group  
Produktgruppe  
Grupo de productos  
Groupe de produits  
Gruppo prodotti

Product Picture & Profile  
Produkt Bild und Profil  
Cuadro del producto y Perfil  
Image de produit et de profil  
Immagine del prodotto e il profilo

Web: www.surtex-instruments.co.uk E-mail: sales@surtex-instruments.co.uk

28

Author /  
Product Information  
Autor /  
Produktinformationen  
Autor /  
Información de producto  
Auteur /  
Information produit  
Autore /  
Informazioni sul prodotto

SS-006-11

- SS Product group of discipline
- 006 Consecutive number within the group or discipline
- 11 Size/shaped of the product

- SS Artikelgruppe oder Disziplin
- 006 Laufende Nummer innerhalb der Gruppe oder Disziplin
- 11 Größe/Figur des Instruments

- SS Grupo de artículos o especialidad
- 006 Número corrido dentro del grupo o especialidad
- 11 Tamaño/forma del instrumento

- SS Groupe d'articles ou discipline
- 006 Numéro courant au sein du groupe ou de la discipline
- 11 taille/forme de l'instrument

- SS Gruppo di articoli o, disciplina
- 006 Numero progressivo all'interno del gruppo o della disciplina
- 11 Dimensioni/forma dello strumento

**TECHNICAL TERMS TRANSLATION TABLE**

English	German	French	Italian	Spanish
Accessories	Zubehör	Accessoires	Accessori	Accesorios
Adjustable	Verstellbar	Réglable	Adeguabile	Ajustable
Adult size	Erwachsengröße	Taille adulte	Misura Adulto	Tamaño adulto
Angled	Gewinkelt	Coudé	Piegato	Acodado
Arm	Arm	Bras	Braccio	Braso
Articulation	Gelenkverbindung	Articulation	Articolazione	Articulación
Atrauma	Atraumatisch	Atraumatique	Atraumatico	Atraumático
Ball Type	Kugelende	Embout sphérique	Puntale A Palla	Punta con bola
Blade	Blatt, Valve	Valve	Valva	Valva
Blunt	Stumpf	Mousse	Smusso	Romo
Bone	Knochen	Os	Ossa	Hueso
Bone rongeur	Knochenzange	Gouge	Sgorbia	Gubia
Child size	Kindergröße	Taille enfant	Misura Pediatrica	Tamaño niño
Circumflex	Zirkumflex	Circonflexe	Circonflesso	Circunflejo
Counterbalanced	Gegengewichtig	Contre poids	Contropeso	Contra peso
Curved	Gebogen	Courbe	Curvo	Curvo
Delicate	Ampfindlich	Délicat	Delicato	Delicado
Depth	Tiefe	Profondeur	Profondità	Profundidad
Dissecting	Sezierung	Dissection	Dissezione	Dissección
Dissector	Dissektor	Dissecteur	Dissettore	Dissector
External	Aussen Liegend	Externe	Esterno	Externo
Fine	Dünn, Fein	Fin	Fino	Fino
Fingerplate	Fingerplatte	Contrôle au doigt	Controllo Digitale	Control digital
Flat	Flach, Eben	Plat	Piatto	Piano
Forceps	Pinzette	Pince	Pinza	Pinza
Hand retractor	Handretraktor	Valve à main	Divaricatore A Mano	Separador a mano
Handle	Griff, Stiel	Manche	Manico	Mango
Height	Höhe	Hauteur	Altezza	Altura
Hook	Haken	Crochet	Gancio	Gancho
Infant	Kleinkind	Nourisson	Bambino	Niño de pecho
Jaws	Kinnbacken	Mors	Morso	Boca
Knot pusher	Schlingengabel	Pousse noeud	Stringinodo	Empujador de nudo
Large	Gross	Grand	Grande	Alto
Left	Links	Gauche	Sinistro	A la Izquierda
Length	Länge	Longueur	Lunghezza	Longitud
Ligature	Unterbindung	Ligature	Ligatura	Ligatura
Lung	Lunge	Poumon	Polmone	Pulmón
Medium	Mittel	Moyen	Medio	Medio
Multipurpose	Mehrzweck	Multi-fonctions	Funzione Multipla	Multi-función
Needle holder	Nadelhalter	Porte aiguille	Portaghi	Porta agujas
Needle pulling	Nadelaufnehmer	À saisir les aiguilles	Pinza Stringi Ago	Para coger las agujas
Newborn	Neugeborenen	Nouveau né	Neonato	Recién nacido
On Flat	Flach	Sur le plat	Piatto En	En el plano
Opening	Öffnung	Ouverture	Apertura	Apertura
Pair	Paar	Paire	Paia	Pár
Prong	Zinke	Griffe	Denti	Dientes
Rack	Gestell	Crémaillère	Cremagliera	Cremallera
Raspatory	Schabeisen	Rugine	Raschiatoio	Raspador
Ratchet	Sperre	Crémaillère	Cremagliera	Cremallera
Retractor	Retraktor	Ecarteur	Divaricatore	Separador
Rib contractor	Rippenschliesser	Rapprocheur de côtes	Appaltatore DI Costole	Aproximador costal
Right	Rechts	Droite	Destra	A la derecha
Ring Handle	Ringgriff	A anneaux	Ad Anelli	Con anillos
Ring Tip	Ringspitze	Embout en anneau	Punta Ad Anelli	Punta con anillo
Rongeur	Knochenzange	Gouge	Sgorbia	Gubia
Round	Rund	Rond	Ton Do	Redondo
Scissors	Schere	Ciseaux	Forbici	Tijeras
Serrated	Gezähnt	Strié	Striato	Estriado
Shanks	Schenkel	Branches	Ramo	Mango
Sharp	Scharf	Acéré	Acute	Acerado
Small	Klein	Petit	Piccolo	Pequeño
Smooth	glatt	Lisse	Liscio	Liso
Spatula	Spatel	Spatule	Spatula	Espátula
Straight	Gerade	Droit	Dritto	Recto
Suction tube	Saugrohr	Canule d'aspiration	Canula DI Aspirazione	Cánula de aspiración
Suture passer	Suture passer	Tire-Fil	Passa-fili	Pasa-hilo
Teeth	Zähne	Dents	Denti	Dientes
Thermic purge	Thermische	Purgeur	Purgatore	Purgador
Thin	Dünn	Etroit	Ristretto	Estrecho
Thread	Faden, Zwirn	Torsade	Filo	Hilo
Tip	Spitze	Bout	Estremità	Punta
Tissue seizing	Gewebegrasse	Préhension	Presca	Presión
Twister	Dreher	Pince à torsader	Cerchiatura	Pinza para retorcer
Tying forceps	Binden	Dissection	Dissezione	Dissección
Vessel	Gefäß	Vaisselleau	Vaso	Vaso
Width	Breite / Weite	Largeur	Larghezza	Anchura
Wire Cutter	Drahtschneider	Coupe-Fils	Taglia Cavo	Alicata para cortar alambre
With / Without	Mit / Ohne	Avec / Sans	Con / Senza	Con / Sin



MEASUREMENTS, STANDARDS, AND CONVERSIONS

Millimeter Equivalents

MM = INCHES	MM = INCHES	MM = INCHES
.1 = .00384	29.0 = 1.14173	65.0 = 2.55905
.2 = .00787	30.0 = 1.18110	66.0 = 2.59842
.3 = .01181	31.0 = 1.22047	67.0 = 2.63779
.4 = .01575	32.0 = 1.25984	68.0 = 2.67716
.5 = .01968	33.0 = 1.29921	69.0 = 2.71653
.6 = .02362	34.0 = 1.33858	70.0 = 2.75590
.7 = .02756	35.0 = 1.37795	71.0 = 2.79527
.8 = .03149	36.0 = 1.41732	72.0 = 2.83464
.9 = .03543	37.0 = 1.45669	73.0 = 2.87401
1.0 = .03937	38.0 = 1.49606	74.0 = 2.91338
2.0 = .07874	38.1 = 1.5 in	75.0 = 2.95275
3.0 = .11811	39.0 = 1.53543	76.0 = 2.99212
4.0 = .15748	40.0 = 1.57480	76.2 = 3.0 in
5.0 = .19685	41.0 = 1.61417	77.0 = 3.03149
6.0 = .23622	42.0 = 1.65354	78.0 = 3.07056
7.0 = .27559	43.0 = 1.69291	79.0 = 3.11023
8.0 = .31496	44.0 = 1.73228	80.0 = 3.14960
9.0 = .35433	45.0 = 1.77165	81.0 = 3.18897
10.0 = .39370	46.0 = 1.81102	82.0 = 3.22834
11.0 = .43307	47.0 = 1.85039	83.0 = 3.26771
12.0 = .47244	48.0 = 1.88976	84.0 = 3.30708
12.7 = .5 in	49.0 = 1.92913	85.0 = 3.34645
13.0 = .51181	50.0 = 1.96350	86.0 = 3.38582
14.0 = .55118	50.8 = 2.0 in	87.0 = 3.42519
15.0 = .59055	51.0 = 2.00787	88.0 = 3.46456
16.0 = .62992	52.0 = 2.04724	88.9 = 3.5 in
17.0 = .66929	53.0 = 2.08661	89.0 = 3.50393
18.0 = .70866	54.0 = 2.12598	90.0 = 3.54330
19.0 = .74803	55.0 = 2.16535	91.0 = 3.58267
20.0 = .78740	56.0 = 2.20472	92.0 = 3.62204
21.0 = .82677	57.0 = 2.24409	93.0 = 3.66141
22.0 = .86614	58.0 = 2.28346	94.0 = 3.70078
23.0 = .90551	59.0 = 2.32283	95.0 = 3.74015
24.0 = .94488	60.0 = 2.36220	96.0 = 3.77952
25.0 = .98425	61.0 = 2.40157	97.0 = 3.81889
25.4 = 1.0 in	62.0 = 2.44094	98.0 = 3.85826
26.0 = 1.02362	63.0 = 2.48031	99.0 = 3.89763
27.0 = 1.06299	63.5 = 2.5 in	100.0 = 3.93700
28.0 = 1.10236	64.0 = 2.51968	101.6 = 4.0 in

Needle Tubing Equivalents

SIZE GAUGE NO.	APPROX. O.D.	
	MM	INCHES
26	0.4	.018
24	0.5	.022
22	0.7	.028
20	0.9	.035
18	1.3	.053
16	1.6	.065
14	2.1	.083
12	2.8	.109
10	3.4	.134
8	4.2	.165
6	5.1	.203

Suction Tubing Equivalents

SIZE FRENCH GAUGE NO.	APPROX. O.D.	
	MM	INCHES
3	1.0	.039
4	1.3	.053
5	1.7	.066
6	2.0	.079
7	2.3	.092
8	2.7	.105
9	3.0	.118
10	3.3	.131
11	3.7	.144
12	4.0	.158
13	4.3	.170
14	4.7	.184
15	5.0	.197
16	5.3	.210





TABLE OF CONTENTS









<p><b>SL</b></p> <p>Scalpel Skalpelle Bisturies Bistouris Bisturi</p>  <p>• Page • Seite • página • page • pagina 1 - 25</p>	<p><b>DI</b></p> <p>Diagnostics Diagnostik Diagnóstico Diagnostic Diagnostica</p>  <p>• Page • Seite • página • page • pagina 387 - 397</p>
<p><b>SS</b></p> <p>Scissors Scheren Tijeras Ciseaux Forbici</p>  <p>• Page • Seite • página • page • pagina 26 - 140</p>	<p><b>TR</b></p> <p>Trocars, Suction Tubes, Cannulas Trokare, Sauger, Kanülen Trócares, Tubos de Aspiración, Cánulas Trocarts, Tubes d'aspiration, Canules Trequarti, Tubi d'aspirazione, Cannule</p>  <p>• Page • Seite • página • page • pagina 398 - 416</p>
<p><b>FR</b></p> <p>Forceps Pinzetten Pinzas Pincas Pinze</p>  <p>• Page • Seite • página • page • pagina 141 - 214</p>	<p><b>AN</b></p> <p>Anesthesia Narkose Anestesia Anesthésie Anestesia</p>  <p>• Page • Seite • página • page • pagina 417 - 426</p>
<p><b>AF</b></p> <p>Artery Forceps Arterienklemmen Pinzas hemostáticas Pincas hémostatiques Pinze emostatiche</p>  <p>• Page • Seite • página • page • pagina 215 - 279</p>	<p><b>SU</b></p> <p>Suture Naht Sutura Suture Sutura</p>  <p>• Page • Seite • página • page • pagina 427 - 483</p>
<p><b>SF</b></p> <p>Cotton Swap Forceps Tupfer- und Korzangen Pinzas para tapones y curaciones Pincas á tampones et á pansements Pinze per tamponi e per medicazione</p>  <p>• Page • Seite • página • page • pagina 280 - 287</p>	<p><b>DR</b></p> <p>Dressings Verband Vendajes Pansements Bendaggi</p>  <p>• Page • Seite • página • page • pagina 484 - 488</p>
<p><b>RT</b></p> <p>Retractor Wundhaken Separdores Ecarteurs Divaricatori</p>  <p>• Page • Seite • página • page • pagina 288 - 375</p>	<p><b>OR</b></p> <p>Bone Surgery Knochenchirurgie Cirugía ósea Chirurgie osseuse Chirurgia ossea</p>  <p>• Page • Seite • página • page • pagina 489 - 599</p>
<p><b>PR</b></p> <p>Probes, Applicators, Spatulas Sonden, Watteträger, Spatel Sondas, Porta-algodones, Espátulas Sondes, porte-cotons, spatules Sonde, Portacotoni, Spatole</p>  <p>• Page • Seite • página • page • pagina 376 - 386</p>	<p><b>DM</b></p> <p>Dermatology Dermatologie Dermatología Dermatologie Dermatologia</p>  <p>• Page • Seite • página • page • pagina 600 - 604</p>

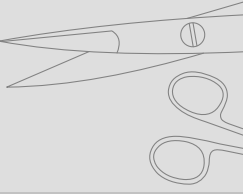
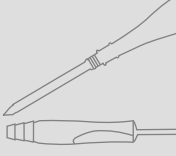
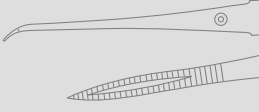
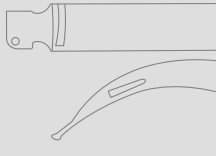

TABLE OF CONTENTS

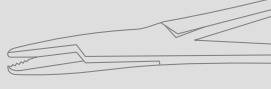
SI

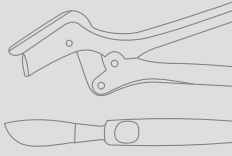
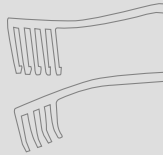
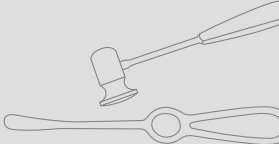
Stomach, Intestine & Rectum  
Magen, Darm, Rektum  
Estómago, Intestinos, Recto  
Estomac, Intestins, Rectum  
Stomaco, Intestini, Retto

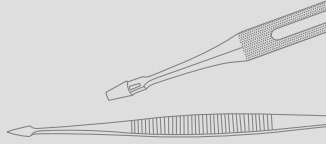
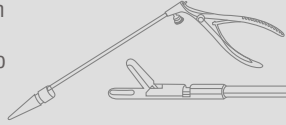

• Page • Seite • página • page • pagina 605 - 633

HW

Holloware  
Hohlwaren  
Holloware  
Platerie  
Holloware



• Page • Seite • página • page • pagina 647 - 657

UR

Liver, Gall Bladder, Kidney & Urology  
Leber, Galle, Niere, Urologie  
Higado, Biliares, Renales, Urologia  
Foie, Biliaire, Rénaux, Urologie  
Fegato, Biliari, Renali, Urologia

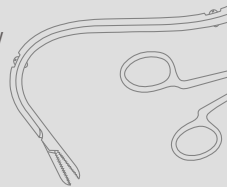

• Page • Seite • página • page • pagina 634 - 646





**SURTEX**  
INSTRUMENTS

*Crafted to Excellence*



Surtex scalpel handles and blades are set apart due to their precision, consistency and reliability. A preferred choice of health care professionals worldwide, the Surtex brand offers a comprehensive range that caters to all surgical disciplines.

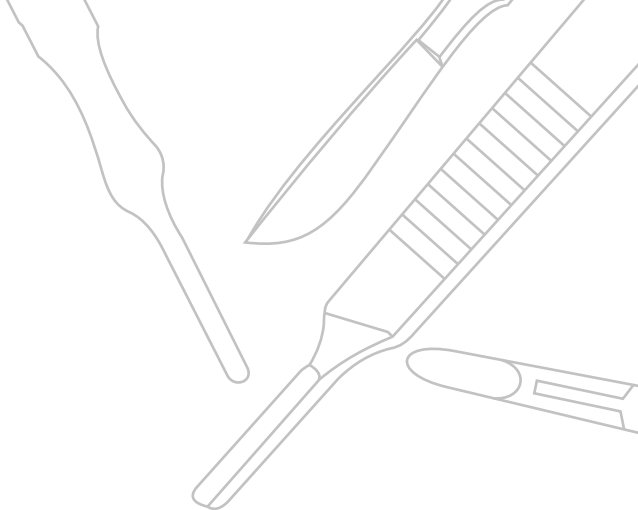

SL

## SCALPELS, KNIVES

Skalpelle, Messer

Bisturís, Cuchillos

Bistouris, Couteaux

Bisturi, Coltelli



Scalpel Handles  
Skalpellgriffe  
Mangos de bisturís  
Manches pour bistouris  
Manici per bisturi

**Scalpel Handle # 3**  
Solid



Catalog #	Size
SL-010-03	12 cm (4 3/4")

**Scalpel Handle # 4**  
Solid



Catalog #	Size
SL-010-04	13.5 cm (5 1/4")

**Scalpel Handle # 3 & 4**  
Solid, Double Ended



Catalog #	Size
SL-010-34	16 cm (6 1/4")

**Scalpel Handle # 3**  
Solid, CM Graduation



Catalog #	Size
SL-012-03	12 cm (4 3/4")

**Scalpel Handle # 3L**  
Solid, Long



Catalog #	Size
SL-020-13	21.5 cm (8 1/2")



Scalpel Handles  
Skalpellgriffe  
Mangos de bisturios  
Manches pour bistouris  
Manici per bisturi

**Scalpel Handle # 4L**  
Solid, Long



Catalog #	Size
SL-020-14	21 cm (8 1/4")

**Scalpel Handle # 3L**  
Solid, Angled, Long



Catalog #	Size
SL-021-13	21 cm (8 1/4")

**Scalpel Handle # 4L**  
Solid, Angled, Long



Catalog #	Size
SL-021-14	21 cm (8 1/4")

**Scalpel Handle # 7**  
Solid



Catalog #	Size
SL-030-07	16 cm (6 1/4")

**Scalpel Handle # 7K**  
Solid, Short



Catalog #	Size
SL-030-17	12.5 cm (5")



Scalpel Handles  
Skalpellgriffe  
Mangos de bisturíes  
Manches pour bistouris  
Manici per bisturi

**Collin Scalpel Handle # 8**  
With Hollow Handle



Catalog #	Size
SL-032-08	13.5 cm (5 1/4")

**Collin Scalpel Handle # 9**  
With Hollow Handle



Catalog #	Size
SL-032-09	14.5 cm (5 3/4")

**Scalpel Handle # 3**  
With Round Hollow Handle



Catalog #	Size
SL-050-03	15.5 cm (6")

**Scalpel Handle # 3**  
Solid, Round Handle



Catalog #	Size
SL-052-03	14.5 cm (5 3/4")

**Scalpel Handle # 3**  
Solid, Round Handle, Angled



Catalog #	Size
SL-053-03	14 cm (5 1/2")

INCHES  
MILLIMETERS





Scalpel Blades  
Skalpellklingen  
Hojas de bisturios  
Lames pour bistouris  
Lame per bisturi

**Kaye Scalpel Handle # 3**  
Solid, Round Handle



Catalog #	Size
SL-056-03	15 cm (6")

**Scalpel Blade # 10**  
Pack of 100



Catalog #	Shape
SL-100-10	Fig. 10

**Scalpel Blade # 11**  
Pack of 100



Catalog #	Shape
SL-100-11	Fig. 11

**Scalpel Blade # 12**  
Pack of 100

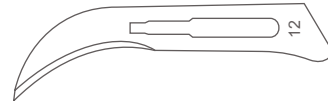

Catalog #	Shape
SL-100-12	Fig. 12

**Scalpel Blade # 13**  
Pack of 100



Catalog #	Shape
SL-100-13	Fig. 13



Scalpel Blades  
Skalpellklingen  
Hojas de bisturios  
Lames pour bistouris  
Lame per bisturi

**Scalpel Blade # 15**

Pack of 100



Catalog #	Shape
SL-100-15	Fig. 15

**Scalpel Blade # 16**

Pack of 100

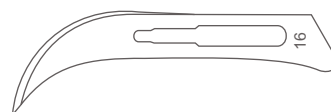

Catalog #	Shape
SL-100-16	Fig. 16

**Scalpel Blade # 17**

Pack of 100



Catalog #	Shape
SL-100-17	Fig. 17

**Scalpel Blade # 18**

Pack of 100



Catalog #	Shape
SL-100-18	Fig. 18

**Scalpel Blade # 19**

Pack of 100



Catalog #	Shape
SL-100-19	Fig. 19



Scalpel Blades  
Skalpellklingen  
Hojas de bisturias  
Lames pour bistouris  
Lame per bisturi

**Scalpel Blade # 20**

Pack of 100

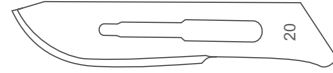

Catalog #	Shape
SL-100-20	Fig. 20

**Scalpel Blade # 21**

Pack of 100



Catalog #	Shape
SL-100-21	Fig. 21

**Scalpel Blade # 22**

Pack of 100



Catalog #	Shape
SL-100-22	Fig. 22

**Scalpel Blade # 23**

Pack of 100



Catalog #	Shape
SL-100-23	Fig. 23

**Scalpel Blade # 24**

Pack of 100



Catalog #	Shape
SL-100-24	Fig. 24



Scalpel Blades  
Skalpellklingen  
Hojas de bisturios  
Lames pour bistouris  
Lame per bisturi

**Scalpel Blade # 34**  
Pack of 100

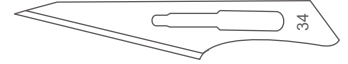

Catalog #	Shape
SL-100-34	Fig. 34

**Scalpel Blade # 12D**  
Pack of 100

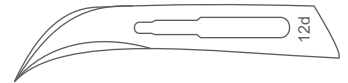

Catalog #	Shape
SL-101-12	Fig. 12D

**Scalpel Blade # 15C**  
Pack of 100



Catalog #	Shape
SL-101-15	Fig. 15C

**Scalpel Blade # 36**  
Pack of 100

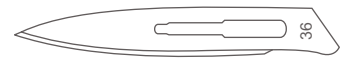

Catalog #	Shape
SL-100-36	Fig. 36

**Scalpel Blade Remover**



Catalog #	Size
SL-150-00	Standard



Scalpel Blades  
Skalpellklingen  
Hojas de bisturios  
Lames pour bistouris  
Lame per bisturi

**Scalpel Handle**

For Micro Scalpel Blades, Titanium



Catalog #	Size
SL-200-00	13.5 cm (5 1/4")

**Scalpel Handle**

For Micro Scalpel Blades, Stainless Steel



Catalog #	Size
SL-202-00	13.5 cm (5 1/4")

**Caspar Scalpel Handle**



Catalog #	Size
SL-204-00	18 cm (7")

**Scalpel Handle**

For Micro Scalpel Blades



Catalog #	Size
SL-206-10	10 cm (4")
SL-206-13	13 cm (5")
SL-206-15	15 cm (6")

**Landolt Scalpel Handle**

Bayonet Shaped, Round Handle



Catalog #	Size
SL-207-00	25 cm (10")



Scalpel Blades  
Skalpellklingen  
Hojas de bisturios  
Lames pour bistouris  
Lame per bisturi

**Landolt Scalpel Handle**

Bayonet Shaped, Square Handle



Catalog #	Size
SL-209-00	21 cm (8 1/4")

**Micro Scalpel Blade # 61**

Pack of 25



Catalog #	Shape
SL-210-61	Fig. 61

**Micro Scalpel Blade # 62**

Pack of 25



Catalog #	Shape
SL-210-62	Fig. 62

**Micro Scalpel Blade # 63**

Pack of 25



Catalog #	Shape
SL-210-63	Fig. 63

**Micro Scalpel Blade # 64**

Pack of 25



Catalog #	Shape
SL-210-64	Fig. 64



Scalpel Blades  
Skalpellklingen  
Hojas de bisturios  
Lames pour bistouris  
Lame per bisturi

**Micro Scalpel Blade # 65**

Pack of 25



Catalog #	Shape
SL-210-65	Fig. 65

**Micro Scalpel Blade # 66**

Pack of 25



Catalog #	Shape
SL-210-66	Fig. 66

**Micro Scalpel Blade # 67**

Pack of 25



Catalog #	Shape
SL-210-67	Fig. 67

**Micro Scalpel Blade # 68**

Pack of 25

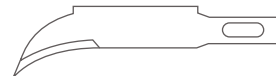

Catalog #	Shape
SL-210-68	Fig. 68

**Micro Scalpel Blade # 69**

Pack of 25



Catalog #	Shape
SL-210-69	Fig. 69





Operating Knives  
Operating Skalpelle  
Bisturíes para operaciones  
Bistouris pour opérations  
Bisturi per interventi

**Operating Knife**

With Metal Handle, Blade Size 35 mm



Catalog #	Size
SL-300-07	15 cm (6")

**Operating Knife**

With Metal Handle, Blade Size 40 mm



Catalog #	Size
SL-300-08	16 cm (6 1/4")

**Operating Knife**

With Metal Handle, Blade Size 30 mm



Catalog #	Size
SL-300-01	15 cm (6")

**Operating Knife**

With Metal Handle, Blade Size 36 mm



Catalog #	Size
SL-300-02	15 cm (6")

**Operating Knife**

With Metal Handle, Blade Size 40 mm



Catalog #	Size
SL-300-03	15.5 cm (6")

INCHES  
MILLIMETERS



Operating Knives  
Operating Skalpelle  
Bisturios para operaciones  
Bistouris pour opérations  
Bisturi per interventi

**Operating Knife**

With Metal Handle, Blade Size 45 mm



Catalog #	Size
SL-300-04	16 cm (6 1/4")

**Operating Knife**

With Metal Handle, Blade Size 50 mm



Catalog #	Size
SL-300-05	16 cm (6 1/4")

**Operating Knife**

With Metal Handle, Blade Size 27 mm



Catalog #	Size
SL-300-06	15 cm (6")

**Operating Knife**

With Metal Handle, Blade Size 47 mm



Catalog #	Size
SL-300-09	16 cm (6 1/4")

**Operating Knife**

With Metal Handle, Blade Size 50 mm



Catalog #	Size
SL-300-10	17 cm (6 3/4")



Operating Knives  
Operating Skalpelle  
Bisturíes para operaciones  
Bistouris pour opérations  
Bisturi per interventi

**Dieffenbach Operating Knife**  
With Metal Handle



Catalog #	Size
SL-310-01	17 cm (6 3/4")

**Dieffenbach Operating Knife**  
With Metal Handle



Catalog #	Size
SL-310-02	17 cm (6 3/4")

**Dieffenbach Operating Knife**  
With Metal Handle



Catalog #	Size
SL-310-03	17 cm (6 3/4")

**Dieffenbach Operating Knife**  
With Metal Handle



Catalog #	Size
SL-310-04	17 cm (6 3/4")

**Dieffenbach Operating Knife**  
With Metal Handle



Catalog #	Size
SL-310-05	17 cm (6 3/4")



Operating Knives  
Operating Skalpelle  
Bisturies para operaciones  
Bistouris pour opérations  
Bisturi per interventi

**Dieffenbach Operating Knife**  
With Metal Handle



Catalog #	Size
SL-310-06	17 cm (6 3/4")

**Dieffenbach Operating Knife**  
With Metal Handle



Catalog #	Size
SL-310-07	17 cm (6 3/4")

**Dieffenbach Operating Knife**  
With Metal Handle



Catalog #	Size
SL-310-08	17 cm (6 3/4")

**Dieffenbach Operating Knife**  
With Metal Handle



Catalog #	Size
SL-310-09	17 cm (6 3/4")

**Dieffenbach Operating Knife**  
With Metal Handle



Catalog #	Size
SL-310-15	17 cm (6 3/4")



Operating Knives  
Operating Skalpelle  
Bisturíes para operaciones  
Bistouris pour opérations  
Bisturi per interventi

**Dieffenbach Operating Knife**  
With Metal Handle

Catalog #	Size
SL-310-16	17 cm (6 3/4")



**Bergmann Operating Knife**  
With Metal Handle

Catalog #	Size
SL-320-14	14 cm (5 1/2")



**Operating Knife**  
Bellied Blade, Fig. 1

Catalog #	Size
SL-350-01	14 cm (5 1/2")



**Operating Knife**  
Bellied Blade, Fig. 3

Catalog #	Size
SL-350-03	14 cm (5 1/2")



**Operating Knife**  
Bellied Blade, Fig. 4

Catalog #	Size
SL-350-04	14 cm (5 1/2")





Operating Knives  
Operating Skalpelle  
Bisturios para operaciones  
Bistouris pour opérations  
Bisturi per interventi

**Operating Knife**  
Bellied Blade, Fig. 6



Catalog #	Size
SL-350-06	14 cm (5 1/2")

**Operating Knife**  
Bellied Blade, Fig. 7



Catalog #	Size
SL-350-07	14 cm (5 1/2")

**Operating Knife**  
Bellied Blade, Fig. 8



Catalog #	Size
SL-350-08	14 cm (5 1/2")

**Operating Knife**  
Bellied Blade, Fig. 9



Catalog #	Size
SL-350-09	14 cm (5 1/2")

**Operating Knife**  
Sharp Pointed Blade, Fig. 14



Catalog #	Size
SL-350-14	14 cm (5 1/2")



Operating Knives, Post Mortem Knives  
Operating Skalpelle, Organmesser  
Bisturíes para operaciones, Cuchillos para órganos  
Bistouris pour opérations, Couteaux à autopsie  
Bisturi per interventi, Coltelli per autopsia

**Operating Knife**

Sickle Shaped Blade, Fig. 46



Catalog #	Size
SL-361-46	14 cm (5 1/2")



**Operating Knife**

Tenotome, Fig. 63



Catalog #	Size
SL-363-63	14 cm (5 1/2")



**Virchow Autopsy Knife**

With Wooden Handle, Blade Size 100 mm



Catalog #	Size
SL-400-10	25.5 cm (10")

**Virchow Cartilage Knife**

With Wooden Handle, Blade Size 80 mm



Catalog #	Size
SL-402-08	21 cm (8 1/4")





Post Mortem Knives, Brain Knives, Amputation Knives  
Organmesser, Hirnmesser, Amputationsmesser  
Cuchillos para órganos, Cuchillos para cerebro, Cuchillos para amputación  
Couteaux à autopsie, Couteaux à cerveaux, Couteaux à amputation  
Coltli per autopsia, Coltelli per cervello, Coltelli per amputazione

**Walb Post Mortem Knife**  
With Wooden Handle



Catalog #	Size
SL-410-11	26 cm (10 ¼"), Blade Size 110 mm
SL-410-14	29 cm (11 ½"), Blade Size 140 mm
SL-410-17	31 cm (12 ¼"), Blade Size 170 mm

**Virchow Brain Knife**  
With Hollow Handle



Catalog #	Size
SL-420-16	26 cm (10 ¼"), Blade Size 160 mm
SL-420-20	33.5 cm (13 ¼"), Blade Size 200 mm
SL-420-24	38 cm (15"), Blade Size 240 mm

**Liston Amputation Knife**  
With Hollow Handle



Catalog #	Size
SL-450-13	26 cm (10 ¼"), Blade Size 130 mm
SL-450-16	29 cm (11 ½"), Blade Size 160 mm
SL-450-19	32.5 cm (12 ¾"), Blade Size 190 mm
SL-450-22	35 cm (13 ¾"), Blade Size 220 mm



Amputation Knives  
Amputationsmesser  
Cuchillos para amputación  
Couteaux à amputation  
Coltelli per amputazione

**Catlin Amputation Knife**

With Hollow Handle, Blade Size 160 mm



Catalog #	Size
SL-460-16	29 cm (11 1/2")

**Langenbeck Flap Knife**

Blade Size 120 mm



Catalog #	Size
SL-470-12	25 cm (9 3/4")

**Phalangeal Knife**

Blade Size 105 mm



Catalog #	Size
SL-472-10	23.5 cm (9 1/4")

**Interosseous Knife**

Blade Size 110 mm



Catalog #	Size
SL-474-11	24 cm (9 1/2")

**Resection Knife**

Solid Handle, Dissecting End, Blade Size 65 mm



Catalog #	Size
SL-480-65	19 cm (7 1/2")



Amputation Knives, Fistula Knives  
Amputationsmesser, Fistelmesser  
Cuchillos para amputación, Bisturios para fistulas  
Couteaux à amputation, Bistouris à fistules  
Coltelli per amputazione, Bisturi per fistole

**Langenbeck Resection Knife**

Blade Size 55 mm



Catalog #	Size
SL-482-55	18 cm (7")

**Langenbeck Resection Knife**

Blade Size 55 mm



Catalog #	Size
SL-484-55	18 cm (7")

**Simon Fistula Knife**

Fig. 1



SL-488-01, Fig. 1



SL-488-02, Fig. 2



SL-488-03, Fig. 3

Catalog #	Size, Profile
SL-488-01	20 cm (8"), Fig. 1
SL-488-02	20 cm (8"), Fig. 2
SL-488-03	20 cm (8"), Fig. 3



**Ulrich Fistula Knife**



Catalog #	Size
SL-490-22	22.5 cm (9")

**Olivecrona Trigeminal Knife**



Catalog #	Size
SL-493-20	20.5 cm (8")



Tonsil Knives, Razor Knives  
Tonsillennmesser, Rasiermesser  
Bisturies para amigdalas, Navajas  
Bistouris pour amygdales, Rasoirs  
Bisturi per tonsille, Rasoi

### Trigeminal Knife



Catalog #	Size
SL-494-23	23 cm (9")

### Fowler Tonsil Knife



Catalog #	Size
SL-501-20	20 cm (8")

### Abraham Tonsil Knife



Catalog #	Size
SL-503-21	21 cm (8 1/4")

### Masing Cartilage Slitting Knife



Catalog #	Size
SL-505-13	13 cm (5")

### Razor Knife

Hollow Blades on Both Side



Catalog #	Size
SL-551-00	Blade Size 75 mm



Razor Knives, Dermatomes  
Rasiermesser, Dermatomy  
Navajas, Dermatomy  
Rasoirs, Dermatomy  
Rasoi, Dermatomy

**Razor Knife**  
Blade Flat/Hollow

Catalog #	Size
SL-553-00	Blade Size 80 mm



**Record-Arkansas Sharpening Stone**  
In Wooden Case

Catalog #	Size
SL-600-00	150 x 50 mm



**Record-Arkansas Sharpening Stone**

Catalog #	Size
SL-602-00	Standard



**Humby Skin Graft Knife (Dermatome)**

Thickness Adjustable From 0.1 to 1.2 mm, Cutting Width Maximum 155 mm

Catalog #	Size
SL-700-32	32 cm (13")



**Watson Skin Graft Knife (Dermatome)**

Thickness Adjustable From 0.1 to 1.2 mm, Cutting Width Maximum 155 mm

Catalog #	Size
SL-710-30	30.5 cm (12")





Blade Holders / Blade Breakers, Dermatomes  
 Klingenhälter / Kingenbrecher, Dermato-me  
 Porta-hojas / Rompe-hojas de afeitar, Dermátoms  
 Pincettes pour saisir et casser les lames de rasoir, Dermatomes  
 Pinze per afferrare e rompere le lamette de rasoio, Dermatomi

**Skin Graft Knife Blade (Dermatome Blade)**

For SL-700-32 and SL-710-30



Catalog #	Size
SL-712-00	15 cm (6")

**Schink Skin Graft Knife (Dermatome)**

Thickness Adjustable From 0.1 to 1.2 mm, Cutting Width Maximum 100 mm



Catalog #	Size
SL-730-31	31 cm (12 1/4")

**Schink Skin Graft Knife Blade (Dermatome Blade)**

For SL-730-31



Catalog #	Size
SL-732-00	10 cm (4")

**Skin Fixation Plate**



Catalog #	Size
SL-734-00	4 cm, 5 cm, 8 cm, 10 cm

**Silver Skin Graft Knife (Dermatome)**

Thickness Adjustable From 0.1 to 1.2 mm, Cutting Width Maximum 40 mm



Catalog #	Size
SL-740-19	19 cm (7 1/2")



Dermatomes, Blade Holders / Blade Breakers  
Dermatome, Klingenthaler / Kingenbrecher  
Dermátoms, Porta-hojas / Rompe-hojas de afeitar  
Dermatomes, Pincettes pour saisir et casser les lames de rasoir  
Dermatomi, Pinze per afferrare e rompere le lamette de rasoio

**Karp Aorta Punch**

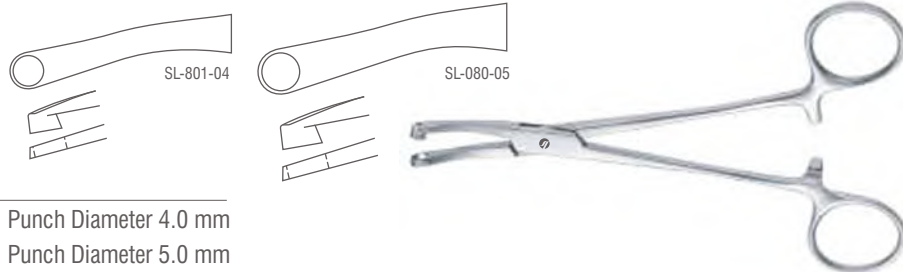

Catalog #	Size, Profile
SL-801-04	16 cm (6 1/4"), Punch Diameter 4.0 mm
SL-801-05	16 cm (6 1/4"), Punch Diameter 5.0 mm

**Troutman-Chris Blade Holder/Breaker**

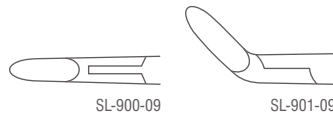

Catalog #	Size, Profile
SL-900-09	9 cm (3 1/2"), Round Handle, Straight
SL-901-09	9 cm (3 1/2"), Round Handle, Angled



**Barraquer Blade Holder/Breaker**



Catalog #	Size
SL-910-11	11 cm (4 1/4")

**Castroviejo Blade Holder/Breaker**  
Round Handle



Catalog #	Size
SL-916-13	13 cm (5")

**Silver Skin Graft Knife Blade**  
Pack of 10



Catalog #	Size
SL-950-10	Standard







**SURTEX**  
INSTRUMENTS

*Crafted to Excellence*



SS

## SCISSORS

Surtex scissors are renowned for their **X<sub>edge</sub>**™ technology enabling users to experience a new dimension in cutting and dissecting performance. Surtex unique **X<sub>edge</sub>**™ leading cutting technology allows scissors to self sharpen as the design ensures the scissor hinge provides spring tension on the two blades so, as they cut material, one blade presses against the other, sharpening the surface as they close. Surtex **X<sub>edge</sub>**™ scissors permit minimum force but confer maximum cutting strength in all types of soft tissues even after pro-longed use.

In addition to standard **X<sub>edge</sub>**™ our scissors are available in the following finishes:

### **SUPER<sub>Edge</sub>**™ Super Cut Scissors

These scissors deliver unbeatable performance when cutting soft tissues because one blade is manufactured with micro-serrations perpendicular to the cutting edge and the other blade has a bevel-honed edge resulting in scissors that cut forward.

The special micro serrations in conjunction with the uniquely ground edges ensure precise, fine and minimally traumatizing cuts. All popular models are available in this finish and identified by black ring handles.

### **ULTRA<sub>Cut</sub>**™ Tungsten Carbide Scissors

These scissors feature carbide inserts a material tougher than stainless steel enabling the scissors to last up to 6 times longer than standard inserts. These scissors are recommended for use in the cutting of cartilage and furr. All popular models are available in this finish and identified by 18K gold plated ring handles.

### **X<sub>TSCut</sub>**™ Super Cut + Tungsten Carbide Scissors

These are the best scissors in our range and combine features of both **ULTRA<sub>Cut</sub>**™ & **SUPER<sub>Edge</sub>**™ featuring a combination of tungsten carbide inserts and special micro serrations to deliver the ultimate in cutting performance. All popular model are available in this finish and identified by 18K gold plated & black ring handles.

**WARNING:** **X<sub>TSCut</sub>**™ Super Cut Scissors must not be used for cutting wire or other hard objects. They should also not be used for cutting hair, fur, or tendons as this may irreversibly damage the blades and invalidate your warranty.

Scheren

Tijeras

Torbici

Ciseaux



Operating Scissors  
Chirurgische Scheren  
Tijeras quirúrgicas  
Ciseaux chirurgicaux  
Forbici per chirurgia

**Operating Scissors**  
Straight, Blunt/Blunt

Catalog #	Size
SS-002-11	12 cm (4 3/4")
SS-002-13	13 cm (5")
SS-002-14	14.5 cm (5 3/4")
SS-002-16	16.5 cm (6 1/2")
SS-002-18	18.5 cm (7 1/4")
SS-002-20	20.5 cm (8")



**Operating Scissors**  
Curved, Blunt/Blunt

Catalog #	Size
SS-003-11	12 cm (4 3/4")
SS-003-13	13 cm (5")
SS-003-14	14.5 cm (5 3/4")
SS-003-16	16.5 cm (6 1/2")
SS-003-18	18.5 cm (7 1/4")
SS-003-20	20.5 cm (8")

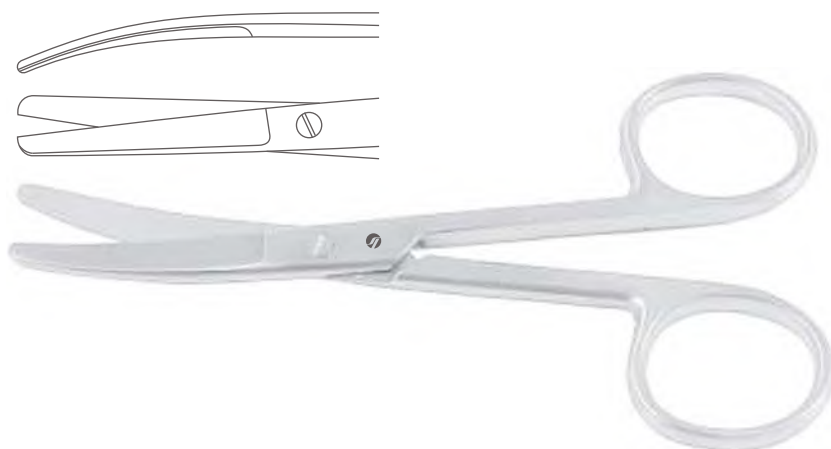

**Operating Scissors**  
Straight, Sharp/Blunt

Catalog #	Size
SS-004-11	12 cm (4 3/4")
SS-004-13	13 cm (5")
SS-004-14	14.5 cm (5 3/4")
SS-004-16	16.5 cm (6 1/2")
SS-004-18	18.5 cm (7 1/4")
SS-004-20	20.5 cm (8")





Operating Scissors  
Chirurgische Scheren  
Tijeras quirúrgicas  
Ciseaux chirurgicaux  
Forbici per chirurgia

**Operating Scissors**  
Straight, Sharp/Blunt

**SUPER Edge™**

Catalog #	Size
SS-004-13 SC	13 cm (5")
SS-004-14 SC	14.5 cm (5 ¾")



**Operating Scissors**  
Curved, Sharp/Blunt

Catalog #	Size
SS-005-11	12 cm (4 ¾")
SS-005-13	13 cm (5")
SS-005-14	14.5 cm (5 ¾")
SS-005-16	16.5 cm (6 ½")
SS-005-18	18.5 cm (7 ¼")
SS-005-20	20.5 cm (8")



**Operating Scissors**  
Curved, Sharp/Blunt,

**SUPER Edge™**

Catalog #	Size
SS-005-13 SC	13 cm (5")
SS-005-14 SC	14.5 cm (5 ¾")

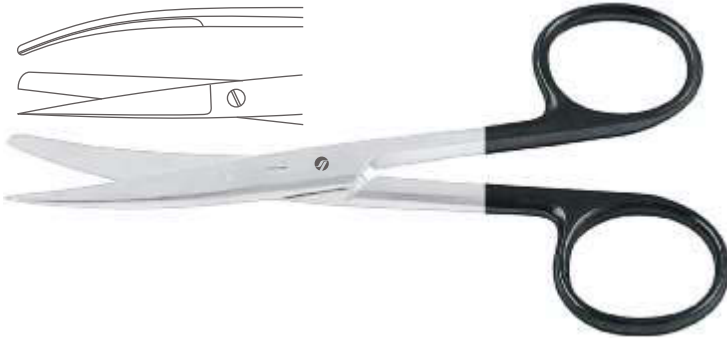

**Operating Scissors**  
Straight, Sharp/Sharp

Catalog #	Size
SS-006-11	12 cm (4 ¾")
SS-006-13	13 cm (5")
SS-006-14	14.5 cm (5 ¾")
SS-006-16	16.5 cm (6 ½")
SS-006-18	18.5 cm (7 ¼")
SS-006-20	20.5 cm (8")





Operating Scissors  
Chirurgische Scheren  
Tijeras quirúrgicas  
Ciseaux chirurgicaux  
Forbici per chirurgia

**Operating Scissors**  
Curved, Sharp/Sharp

Catalog #	Size
SS-007-11	12 cm (4 3/4")
SS-007-13	13 cm (5")
SS-007-14	14.5 cm (5 3/4")
SS-007-16	16.5 cm (6 1/2")
SS-007-18	18.5 cm (7 1/4")
SS-007-20	20.5 cm (8")

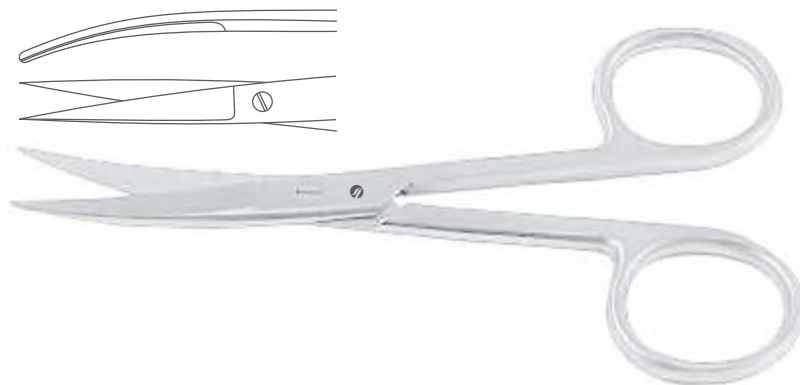

**Operating Scissors**  
Straight, Blunt/Blunt

Catalog #	Size
SS-010-14	14.5 cm (5 3/4")

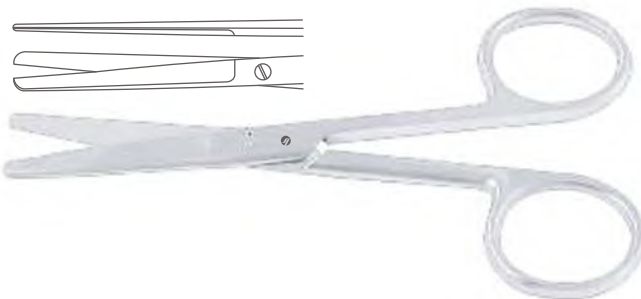

**Operating Scissors**  
Curved, Blunt/Blunt

Catalog #	Size
SS-011-14	14.5 cm (5 3/4")

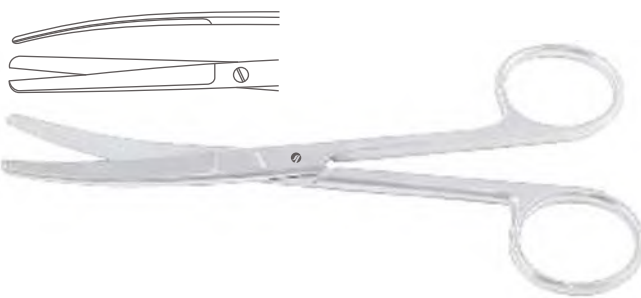

**Operating Scissors**  
Straight, Sharp/Blunt

Catalog #	Size
SS-012-14	14.5 cm (5 3/4")

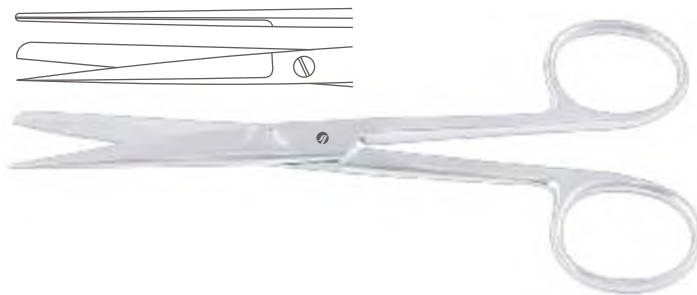



Operating Scissors  
Chirurgische Scheren  
Tijeras quirúrgicas  
Ciseaux chirurgicaux  
Forbici per chirurgia

**Operating Scissors**  
Curved, Sharp/Blunt



Catalog #	Size
SS-013-14	14.5 cm (5 3/4")

**Operating Scissors**  
Straight, Sharp/Sharp



Catalog #	Size
SS-014-14	14.5 cm (5 3/4")

**Operating Scissors**  
Curved, Sharp/Sharp

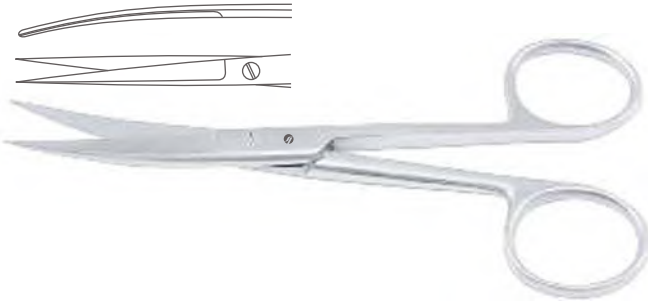

Catalog #	Size
SS-015-14	14.5 cm (5 3/4")

**Incision Scissor**  
Straight



Catalog #	Size
SS-018-13	13 cm (5")
SS-020-14	14.5 cm (5 3/4")
SS-022-16	16.5 cm (6 1/2")

**Systrunk Nail Splitting Scissor**  
Straight



Catalog #	Size
SS-024-13	13 cm (5")



Operating Scissors, Dissecting Scissors  
Chirurgische Scheren, Präparierscheren  
Tijeras quirúrgicas, Tijeras de disección  
Ciseaux chirurgicaux, Ciseaux à dissection  
Forbici per chirurgia, Forbici per dissezione

**Deaver Operating Scissor**

Straight, Sharp/Blunt

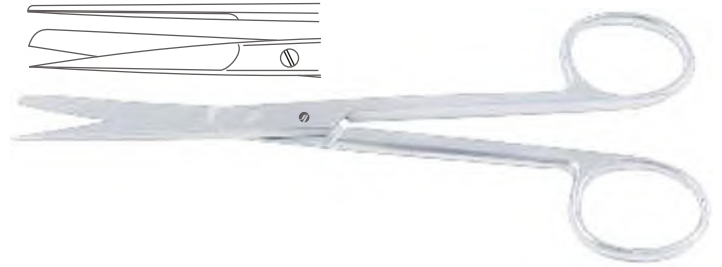

Catalog #	Size
SS-030-14	14 cm (5 1/2")

**Deaver Operating Scissor**

Curved, Sharp/Blunt



Catalog #	Size
SS-031-14	14 cm (5 1/2")

**Mayo Dissecting Scissor**

Straight



Catalog #	Size
SS-040-14	14.5 cm (5 3/4")
SS-040-15	15 cm (6")
SS-040-17	17 cm (6 3/4")
SS-040-23	23.5 cm (9 1/4")

**Mayo Dissecting Scissor**

Straight



**SUPER Edge™**

Catalog #	Size
SS-040-14 SC	14.5 cm (5 3/4")
SS-040-15 SC	15 cm (6")
SS-040-17 SC	17 cm (6 3/4")



Dissecting Scissors  
Präparierscheren  
Tijeras de disección  
Ciseaux à dissection  
Forbici per dissezione

**Mayo Dissecting Scissor**  
Curved

Catalog #	Size
SS-041-14	14.5 cm (5 ¾")
SS-041-15	15 cm (6")
SS-041-17	17 cm (6 ¾")
SS-041-23	23.5 cm (9 ¼")



**Mayo Dissecting Scissor**  
Curved

**SUPER Edge™**

Catalog #	Size
SS-041-14 SC	14.5 cm (5 ¾")
SS-041-15 SC	15 cm (6")
SS-041-17 SC	17 cm (6 ¾")



**Mayo Dissecting Scissor**  
Straight, With Chamfered Blades

Catalog #	Size
SS-042-19	19 cm (7 ½")
SS-042-21	21.5 cm (8 ½")



**Mayo Dissecting Scissor**  
Curved, With Chamfered Blades

Catalog #	Size
SS-043-19	19 cm (7 ½")
SS-043-21	21.5 cm (8 ½")







Dissecting Scissors  
Präparierscheren  
Tijeras de disección  
Ciseaux à dissection  
Forbici per dissezione

**Mayo-Harrington Dissecting Scissor**  
Straight



Catalog #	Size
SS-046-23	23 cm (9")

**Mayo-Harrington Dissecting Scissor**  
Straight



**SUPER Edge™**

Catalog #	Size
SS-046-23 SC	23 cm (9")

**Mayo-Harrington Dissecting Scissor**  
Curved



Catalog #	Size
SS-047-23	22.5 cm (9")
SS-047-28	28 cm (11")

**Mayo-Harrington Dissecting Scissor**  
Curved



**SUPER Edge™**

Catalog #	Size
SS-047-23 SC	22.5 cm (9")





Dissecting Scissors  
Präparierscheren  
Tijeras de disección  
Ciseaux à dissection  
Forbici per dissezione

**Mayo-Stille Dissecting Scissor**  
Straight

Catalog #	Size
SS-050-15	15 cm (6")
SS-050-17	17 cm (6 ¾")
SS-050-19	19.5 cm (7 ¾")
SS-050-21	21.5 cm (8 ½")



**Mayo-Stille Dissecting Scissor**  
Straight

**SUPER Edge™**

Catalog #	Size
SS-050-15 SC	15 cm (6")
SS-050-17 SC	17 cm (6 ¾")



**Mayo-Stille Dissecting Scissor**  
Curved

Catalog #	Size
SS-051-15	15 cm (6")
SS-051-17	17 cm (6 ¾")
SS-051-19	19.5 cm (7 ¾")
SS-051-21	21.5 cm (8 ½")



**Mayo-Stille Dissecting Scissor**  
Curved

**SUPER Edge™**

Catalog #	Size
SS-051-15 SC	15 cm (6")
SS-051-17 SC	17 cm (6 ¾")





Dissecting Scissors, Gynecological Scissors  
Präparierscheren, Gynäkologische Scheren  
Tijeras de disección, Tijeras para ginecología  
Ciseaux à dissection, Ciseaux à gynécologie  
Forbici per dissezione, Forbici per ginecologia

**Mayo-Stille Dissecting Scissor**  
Straight, With Chamfered Blades

Catalog #	Size
SS-052-14	14 cm (5 1/2")
SS-052-17	17 cm (6 3/4")



**Mayo-Stille Dissecting Scissor**  
Curved, With Chamfered Blades

Catalog #	Size
SS-053-14	14 cm (5 1/2")
SS-053-17	17 cm (6 3/4")



**Stille Dissecting Scissor**  
Straight

Catalog #	Size
SS-056-15	15 cm (6")



**Stille Dissecting Scissor**  
Curved

Catalog #	Size
SS-057-15	15 cm (6")



**Mayo-Noble Gynecological Scissor**  
Straight

Catalog #	Size
SS-060-17	16.5 cm (6 1/2")





Gynecological Scissors  
Gynäkologische Scheren  
Tijeras para ginecología  
Ciseaux à gynécologie  
Forbici per ginecologia

**Mayo-Noble Gynecological Scissor**  
Curved

Catalog #	Size
SS-061-17	16.5 cm (6 1/2")



**Sims Gynecological Scissor**  
Straight

Catalog #	Size
SS-070-20	20 cm (8")
SS-070-23	23 cm (9")



**Sims Gynecological Scissor**  
Straight

**SUPER Edge™**

Catalog #	Size
SS-070-20 SC	20 cm (8")
SS-070-23 SC	23 cm (9")



**Sims Gynecological Scissor**  
Curved

Catalog #	Size
SS-071-20	20 cm (8")
SS-071-23	23 cm (9")





Gynecological Scissors  
Gynäkologische Scheren  
Tijeras para ginecología  
Ciseaux à gynécologie  
Forbici per ginecologia

**Sims Gynecological Scissor**  
Curved

**SUPER Edge™**

Catalog #	Size
SS-071-20 SC	20 cm (8")
SS-071-23 SC	23 cm (9")



**Doyen Gynecological Scissor**  
Straight

Catalog #	Size
SS-074-17	18.5 cm (7 1/4")



**Doyen Gynecological Scissor**  
Curved

Catalog #	Size
SS-075-17	18.5 cm (7 1/4")



**Sims-Siebold Gynecological Scissor**  
Straight

Catalog #	Size
SS-078-24	24.5 cm (9 3/4")

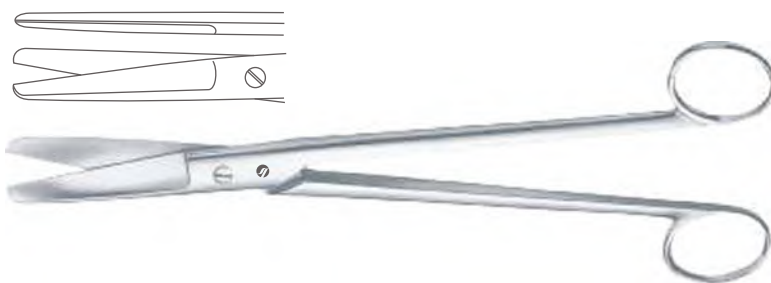

**Sims-Siebold Gynecological Scissor**  
Straight

**SUPER Edge™**

Catalog #	Size
SS-078-24 SC	24.5 cm (9 3/4")





Gynecological Scissors  
Gynäkologische Scheren  
Tijeras para ginecología  
Ciseaux à gynécologie  
Forbici per ginecologia

**Sims-Siebold Gynecological Scissor**  
Curved

Catalog #	Size
SS-079-24	24.5 cm (9 3/4")

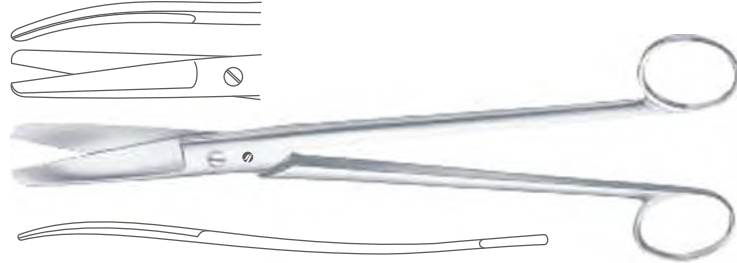

**Sims-Siebold Gynecological Scissor**  
Curved

**SUPER** *Edge*<sup>™</sup>

Catalog #	Size
SS-079-24 SC	24.5 cm (9 3/4")

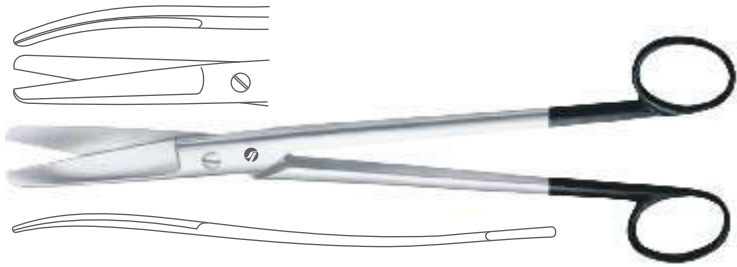

**Sims Gynecological Scissor**  
Straight, Sharp/Sharp

Catalog #	Size
SS-082-20	20 cm (8")

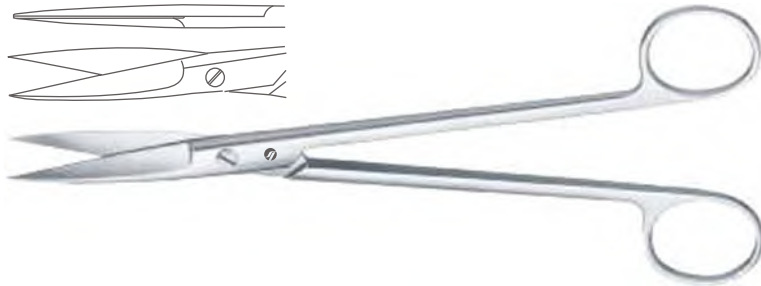

**Sims Gynecological Scissor**  
Curved, Blunt/Blunt

Catalog #	Size
SS-085-21	21 cm (8 1/4")



**Wertheim Gynecological Scissor**  
Curved

Catalog #	Size
SS-087-20	20 cm (8")
SS-087-23	23 cm (9")





Gynecological Scissors, Dissecting Scissors  
Gynäkologische Scheren, Präparierscheren  
Tijeras para ginecología, Tijeras de disección  
Ciseaux à gynécologie, Ciseaux à dissection  
Forbici per ginecologia, Forbici per dissezione

**Bozemann Gynecological Scissor**  
S Shaped

Catalog #	Size
SS-089-22	22 cm (8 3/4")

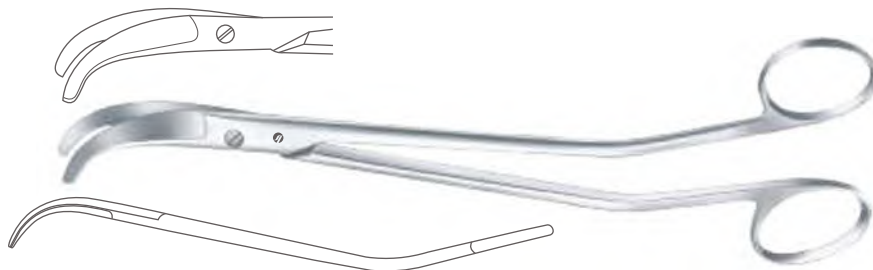

**Kieback Parametrium Scissor**  
Angled 90°

Catalog #	Size
SS-091-24	24 cm (9 1/2")
SS-091-35	35 cm (13 3/4")

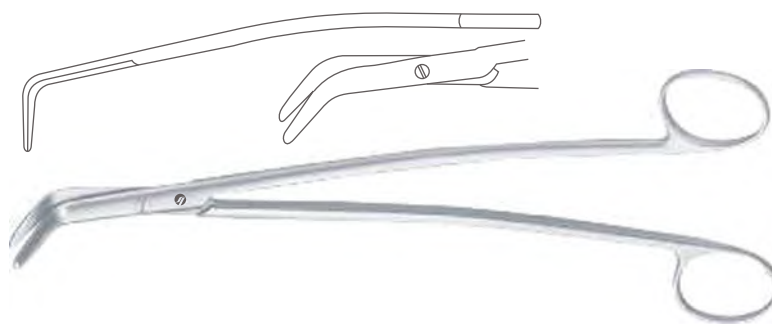

**Kieback Parametrium Scissor**  
Curved to Side, One Probe Pointed Blade  
One Toothed Cutting Edge

Catalog #	Size
SS-093-26	26 cm (10 1/4")
SS-093-35	35 cm (13 3/4")

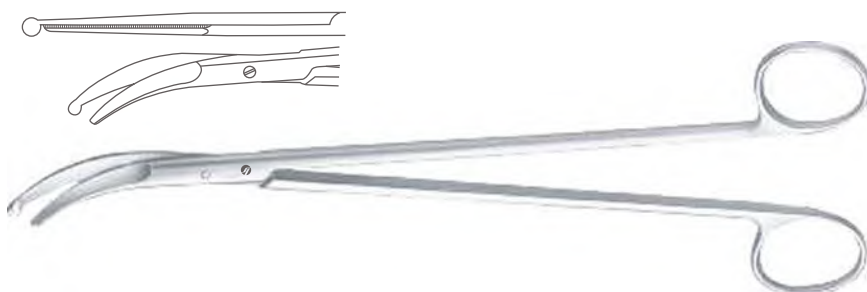

**Kelly Dissecting Scissor**  
Straight

Catalog #	Size
SS-100-16	16 cm (6 1/4")

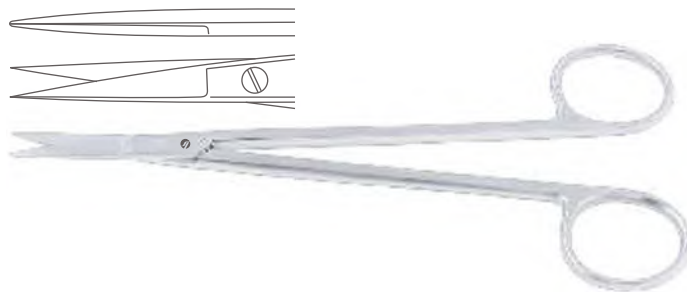

**Kelly Dissecting Scissor**  
Straight

**SUPER Edge™**

Catalog #	Size
SS-100-16 SC	16 cm (6 1/4")

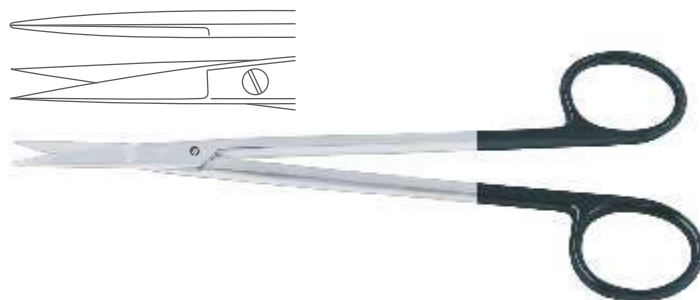





Dissecting Scissors  
Präparierscheren  
Tijeras de disección  
Ciseaux à dissection  
Forbici per dissezione

SS

SCISSORS

**Kelly Dissecting Scissor**  
Curved

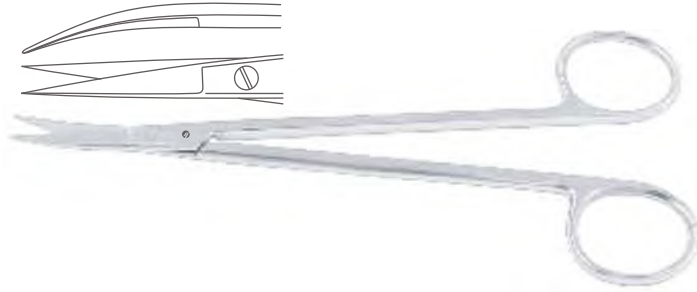

Catalog #	Size
SS-101-16	16 cm (6 1/4")

**Kelly Dissecting Scissor**  
Curved

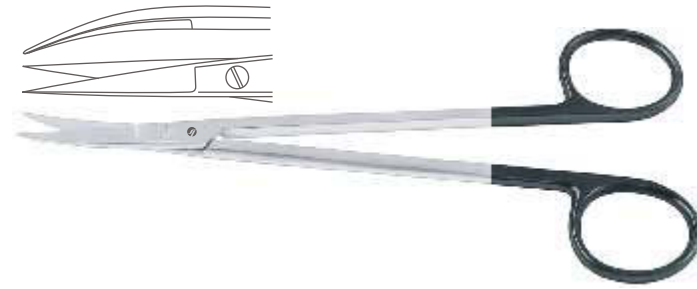

**SUPER Edge™**

Catalog #	Size
SS-101-16 SC	16 cm (6 1/4")

**Joseph Dissecting Scissor**  
Straight

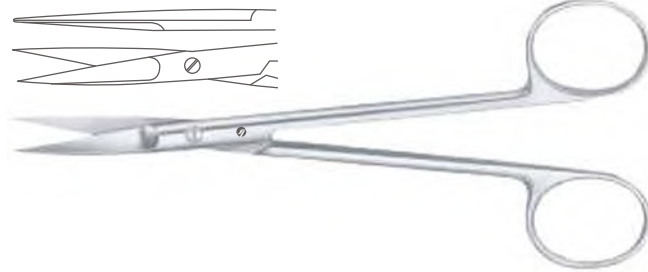

Catalog #	Size
SS-104-15	15 cm (6")

**Joseph Dissecting Scissor**  
Straight



**SUPER Edge™**

Catalog #	Size
SS-104-15 SC	15 cm (6")

**Joseph Dissecting Scissor**  
Curved

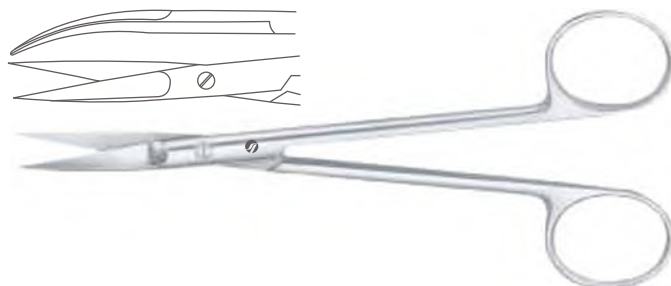

Catalog #	Size
SS-105-15	15 cm (6")



Dissecting Scissors  
Präparierscheren  
Tijeras de disección  
Ciseaux à dissection  
Forbici per dissezione

**Joseph Dissecting Scissor**  
Curved

**SUPER Edge™**

Catalog #	Size
SS-105-15 SC	15 cm (6")

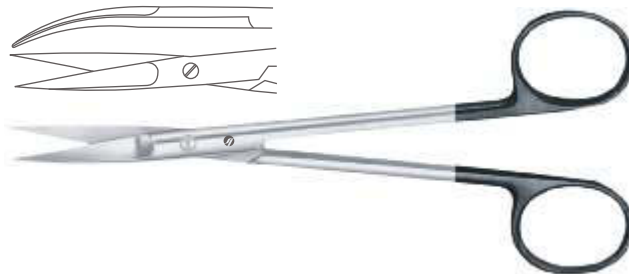

**Weller Dissecting Scissor**  
Heavy Pattern

Catalog #	Size
SS-111-28	28 cm (11")



**Resano Cartilage Scissor**

Catalog #	Size
SS-113-25	25 cm (9 3/4")



**Metzenbaum Dissecting Scissor**  
Straight, Blunt/Blunt

Catalog #	Size
SS-120-11	11.5 cm (4 1/2")

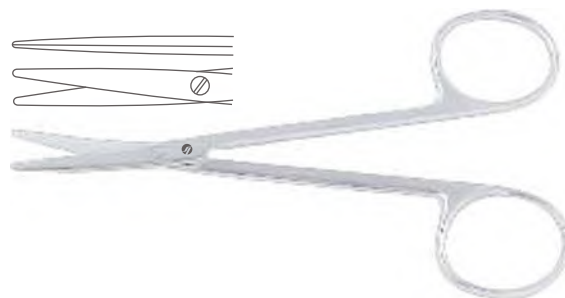

**Metzenbaum Dissecting Scissor**  
Straight, Blunt/Blunt

**SUPER Edge™**

Catalog #	Size
SS-120-11 SC	11.5 cm (4 1/2")

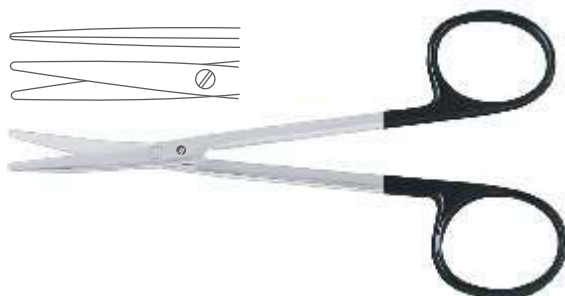





Dissecting Scissors  
Präparierscheren  
Tijeras de disección  
Ciseaux à dissection  
Forbici per dissezione

**Metzenbaum Dissecting Scissor**  
Straight, Blunt/Blunt

**SUPER Edge™**

Catalog #	Size
SS-122-15 SC	15.5 cm (6")



**Metzenbaum Dissecting Scissor**  
Curved, Blunt/Blunt

Catalog #	Size
SS-123-15	15.5 cm (6")

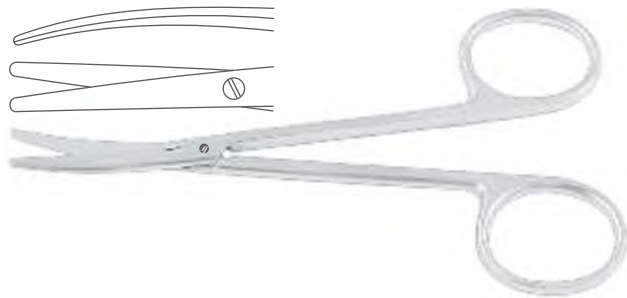

**Metzenbaum Dissecting Scissor**  
Curved, Blunt/Blunt

**SUPER Edge™**

Catalog #	Size
SS-123-15 SC	15.5 cm (6")



**Metzenbaum Dissecting Scissor**  
Straight, Blunt/Blunt

Catalog #	Size
SS-130-14	14.5 cm (5 3/4")



**Metzenbaum Dissecting Scissor**  
Straight, Blunt/Blunt

**SUPER Edge™**

Catalog #	Size
SS-130-14 SC	14.5 cm (5 3/4")





Dissecting Scissors  
Präparierscheren  
Tijeras de disección  
Ciseaux à dissection  
Forbici per dissezione

**Metzenbaum Dissecting Scissor**  
Curved, Blunt/Blunt

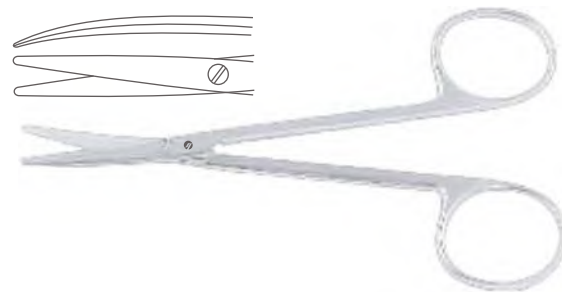

Catalog #	Size
SS-121-11	11.5 cm (4 1/2")

**Metzenbaum Dissecting Scissor**  
Curved, Blunt/Blunt

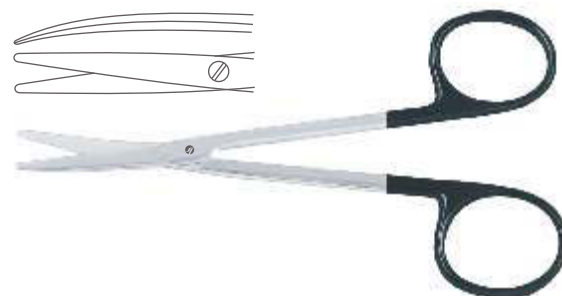

**SUPER Edge™**

Catalog #	Size
SS-121-11 SC	11.5 cm (4 1/2")

**Metzenbaum Dissecting Scissor**  
Straight, Blunt/Blunt



Catalog #	Size
SS-122-15	15.5 cm (6")

**Metzenbaum Dissecting Scissor**  
Curved, Blunt/Blunt



Catalog #	Size
SS-131-14	14.5 cm (5 3/4")

**Metzenbaum Dissecting Scissor**  
Curved, Blunt/Blunt



**SUPER Edge™**

Catalog #	Size
SS-131-14 SC	14.5 cm (5 3/4")

INCHES  
MILLIMETERS



Dissecting Scissors  
Präparierscheren  
Tijeras de disección  
Ciseaux à dissection  
Forbici per dissezione

**Metzenbaum Dissecting Scissor**  
Straight, Sharp/Blunt

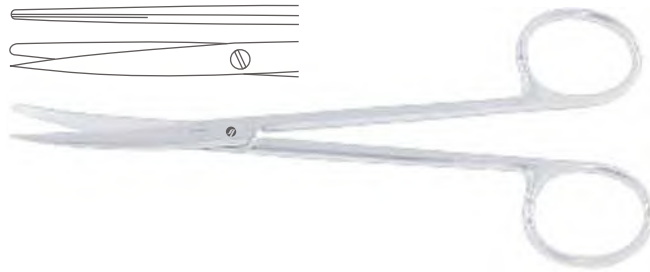

Catalog #	Size
SS-132-14	14.5 cm (5 3/4")

**Metzenbaum Dissecting Scissor**  
Curved, Sharp/Blunt

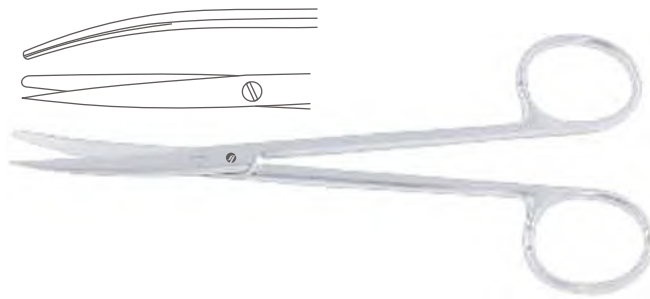

Catalog #	Size
SS-133-14	14.5 cm (5 3/4")

**Metzenbaum Dissecting Scissor**  
Straight, Sharp/Sharp



Catalog #	Size
SS-134-14	14.5 cm (5 3/4")

**Metzenbaum Dissecting Scissor**  
Curved, Sharp/Sharp



Catalog #	Size
SS-135-14	14.5 cm (5 3/4")



Dissecting Scissors  
Präparierscheren  
Tijeras de disección  
Ciseaux à dissection  
Forbici per dissezione

**Metzenbaum-Nelson Dissecting Scissor**  
Straight, Blunt/Blunt

Catalog #	Size
SS-140-18	18 cm (7")
SS-140-20	20.5 cm (8")
SS-140-23	23 cm (9")
SS-140-26	26 cm (10 1/4")
SS-140-28	28.5 cm (11 1/4")
SS-140-30	31 cm (12 1/4")



**Metzenbaum-Nelson Dissecting Scissor**  
Straight, Blunt/Blunt

**SUPER Edge™**

Catalog #	Size
SS-140-18 SC	18 cm (7")
SS-140-20 SC	20.5 cm (8")
SS-140-23 SC	23 cm (9")
SS-140-26 SC	26 cm (10 1/4")

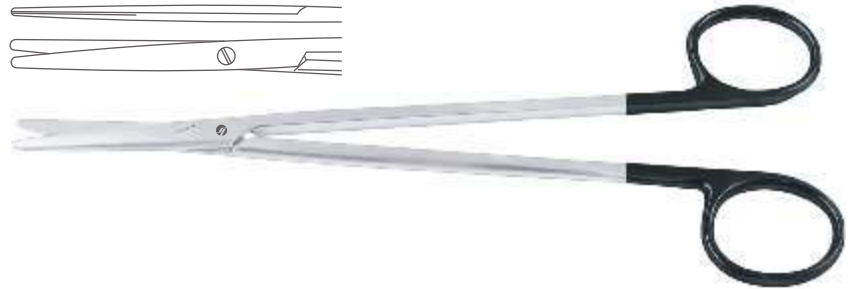

**Metzenbaum-Nelson Dissecting Scissor**  
Curved, Blunt/Blunt

Catalog #	Size
SS-141-18	18 cm (7")
SS-141-20	20.5 cm (8")
SS-141-23	23 cm (9")
SS-141-26	26 cm (10 1/4")
SS-141-28	28.5 cm (11 1/4")
SS-141-30	31 cm (12 1/4")

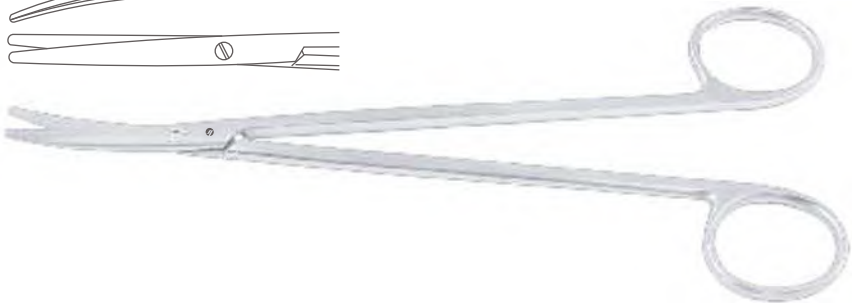
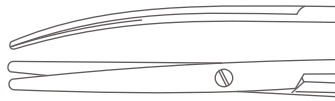



Dissecting Scissors  
Präparierscheren  
Tijeras de disección  
Ciseaux à dissection  
Forbici per dissezione

**Metzenbaum-Nelson Dissecting Scissor**  
Curved, Blunt/Blunt

**SUPER Edge™**

Catalog #	Size
SS-141-18 SC	18 cm (7")
SS-141-20 SC	20.5 cm (8")
SS-141-23 SC	23 cm (9")
SS-141-26 SC	26 cm (10 ¼")



**Metzenbaum-Nelson Dissecting Scissor**  
Straight, Sharp/Sharp

Catalog #	Size
SS-144-18	18 cm (7")
SS-144-20	20.5 cm (8")



**Metzenbaum Dissecting Scissor**  
Straight, Sharp/Sharp, Toothed

Catalog #	Size
SS-146-14	14.5 cm (5 ¾")



**Metzenbaum Dissecting Scissor**  
Curved, Sharp/Sharp, Toothed

Catalog #	Size
SS-147-14	14.5 cm (5 ¾")





Dissecting Scissors, Face-lift Scissors  
Präparierscheren, Face-lift-Scheren  
Tijeras de disección, Tijeras para Face-Lift  
Ciseaux à dissection, Ciseaux pour Face-lift  
Forbici per dissezione, Forbici per Face-lift

**Metzenbaum Nerve Dissecting Scissor**  
Straight

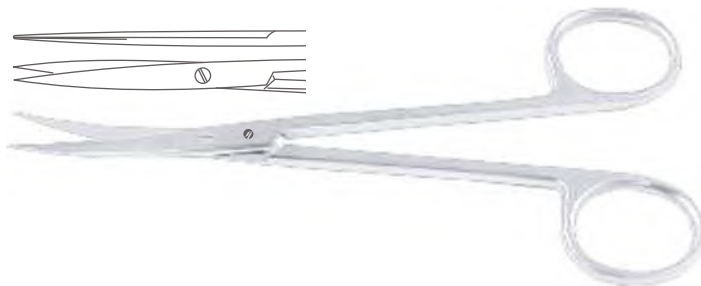

Catalog #	Size
SS-148-15	15.5 cm (6")

**Metzenbaum Nerve Dissecting Scissor**  
Curved

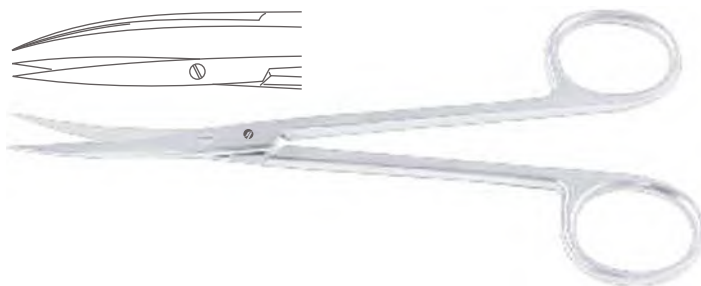

Catalog #	Size
SS-149-15	15.5 cm (6")

**McIndoe Cartilage Scissor**  
Straight, Toothed

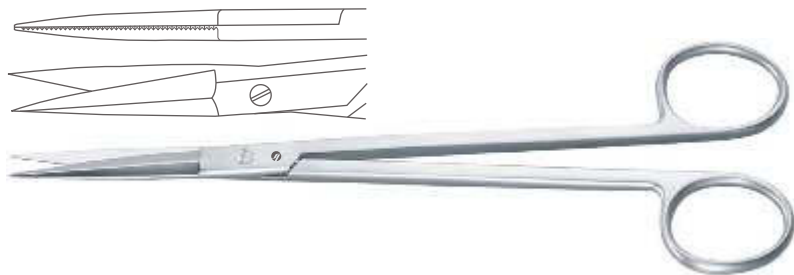

Catalog #	Size
SS-154-18	18.5 cm (7 1/4")

**McIndoe Cartilage Scissor**  
Curved, Toothed



Catalog #	Size
SS-155-18	18.5 cm (7 1/4")

**Kaye Face-Lift Scissor**  
Curved



**SUPER Edge™**

Catalog #	Size
SS-161-18 SC	18.5 cm (7 1/4")



Face-lift Scissors, Dissecting Scissors  
Face-lift-Scheren, Präparierscheren  
Tijeras para Face-Lift, Tijeras de disección  
Ciseaux pour Face-lift, Ciseaux à dissection  
Forbici per Face-lift, Forbici per dissezione

**Gorney Face-Lift Scissor**  
Straight

**SUPER Edge™**

Catalog #	Size
SS-166-12 SC	12.5 cm (5")
SS-166-19 SC	19.5 cm (7 ¾")



**Gorney Face-Lift Scissor**  
Curved

**SUPER Edge™**

Catalog #	Size
SS-167-19 SC	19.5 cm (7 ¾")



**Aston Face-Lift Scissor**  
Straight

**SUPER Edge™**

Catalog #	Size
SS-170-17 SC	17 cm (6 ¾")



**Lexer Dissecting Scissor**  
Straight

Catalog #	Size
SS-176-16	16 cm (6 ¼")



**Lexer Dissecting Scissor**  
Straight

**SUPER Edge™**

Catalog #	Size
SS-176-16 SC	16 cm (6 ¼")







Dissecting Scissors, Nasal Scissors  
Präparierscheren, Nasenscheren  
Tijeras de disección, Tijeras nasales  
Ciseaux à dissection, Ciseaux nasaux  
Forbici per dissezione, Forbici nasali

**Lexer Dissecting Scissor**  
Curved



Catalog #	Size
SS-177-16	16 cm (6 1/4")

**Lexer Dissecting Scissor**  
Curved



**SUPER Edge™**

Catalog #	Size
SS-177-16 SC	16 cm (6 1/4")

**Cottle-Masing Plastic Surgery Scissor**  
Curved, Sharp/Sharp

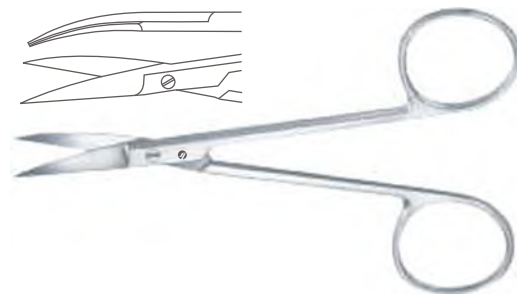

Catalog #	Size
SS-181-10	10.5 cm (4 1/4")

**Cottle-Masing Plastic Surgery Scissor**  
Curved, Blunt/Blunt

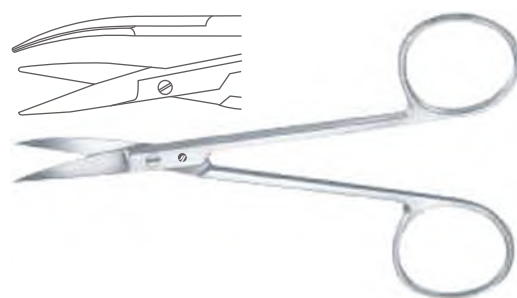

Catalog #	Size
SS-183-10	10.5 cm (4 1/4")

**Cinelli Nasal Scissor**  
Curved



Catalog #	Size
SS-187-11	11.5 cm (4 1/2")





Nasal Scissors, Delicate Dissecting Scissors  
Nasenscheren, Feine Präparierscheren  
Tijeras nasales, Tijeras finas de disección  
Ciseaux nasaux, Ciseaux fins à dissection  
Forbici nasali, Forbici fini per dissezione

**Fomon Nasal Scissor**  
Curved



Catalog #	Size
SS-189-14	14 cm (5 1/2")

**Thorek Dissecting Scissor**  
Curved



Catalog #	Size
SS-191-19	18.5 cm (7 1/4")

**Lexer-Baby Dissecting Scissor**  
Straight



Catalog #	Size
SS-194-10	10 cm (4")

**Lexer-Baby Dissecting Scissor**  
Curved

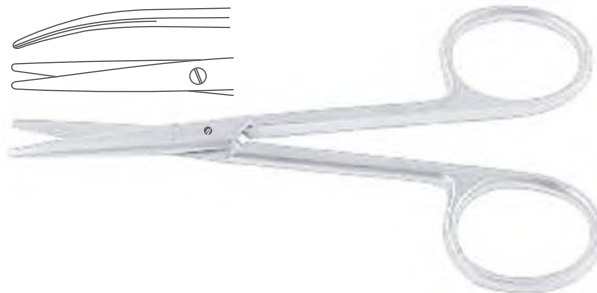

Catalog #	Size
SS-195-10	10 cm (4")

**Lexer-Fine Delicate Dissecting Scissor**  
Straight, Slender Pattern

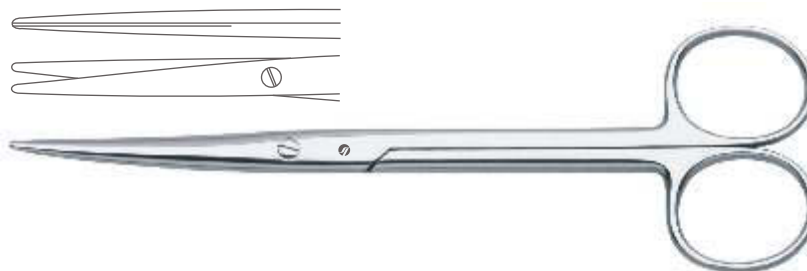

Catalog #	Size
SS-196-16	16.5 cm (6 1/2")



Delicate Dissecting Scissors  
Feine Präparierscheren  
Tijeras finas de disección  
Ciseaux fins à dissection  
Forbici fini per dissezione

**Lexer-Fine Delicate Dissecting Scissor**  
Curved, Slender Pattern



Catalog #	Size
SS-197-16	16.5 cm (6 1/2")

**Metzenbaum-Fine Delicate Dissecting Scissor**  
Straight, Blunt/Blunt, Slender Pattern



Catalog #	Size
SS-200-14	14.5 cm (5 3/4")

**Metzenbaum-Fine Delicate Dissecting Scissor**  
Straight, Blunt/Blunt, Slender Pattern



**SUPER Edge™**

Catalog #	Size
SS-200-14 SC	14.5 cm (5 3/4")

**Metzenbaum-Fine Delicate Dissecting Scissor**  
Curved, Blunt/Blunt, Slender Pattern

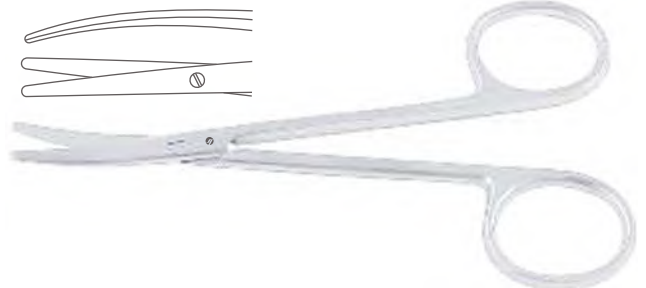

Catalog #	Size
SS-201-14	14.5 cm (5 3/4")

**Metzenbaum-Fine Delicate Dissecting Scissor**  
Curved, Blunt/Blunt, Slender Pattern



**SUPER Edge™**

Catalog #	Size
SS-201-14 SC	14.5 cm (5 3/4")



Delicate Dissecting Scissors  
Feine Präparierscheren  
Tijeras finas de disección  
Ciseaux fins à dissection  
Forbici fini per dissezione

**Metzenbaum-Fine Delicate Dissecting Scissor**  
Straight, Sharp/Sharp, Slender Pattern



Catalog #	Size
SS-202-14	14.5 cm (5 3/4")

**Metzenbaum-Fine Delicate Dissecting Scissor**  
Curved, Sharp/Sharp, Slender Pattern

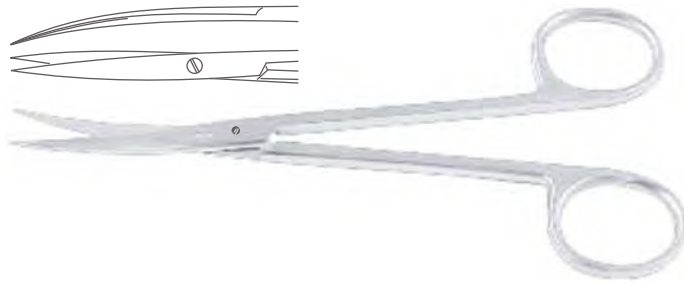

Catalog #	Size
SS-203-16	14.5 cm (5 3/4")

**Metzenbaum-Fine Delicate Dissecting Scissor**  
Straight, Blunt/Blunt, Slender Pattern

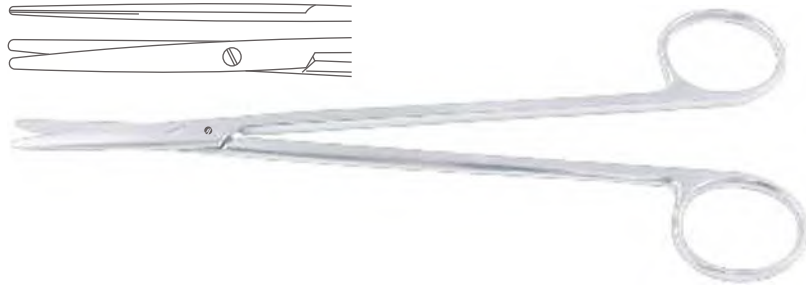

Catalog #	Size
SS-210-18	18 cm (7")
SS-210-20	20 cm (8")
SS-210-23	23 cm (9")

**Metzenbaum-Fine Delicate Dissecting Scissor**  
Straight, Blunt/Blunt, Slender Pattern

**SUPER Edge™**

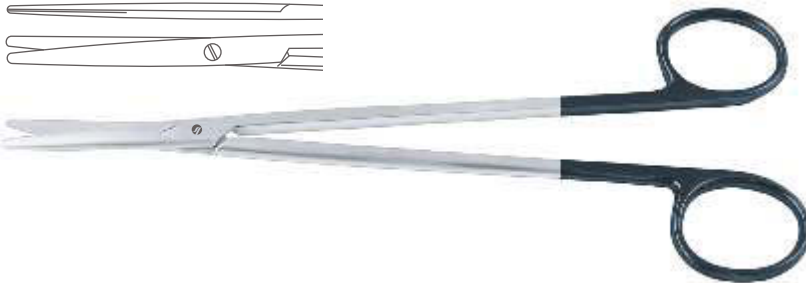

Catalog #	Size
SS-210-18 SC	18 cm (7")
SS-210-20 SC	20 cm (8")
SS-210-23 SC	23 cm (9")



Delicate Dissecting Scissors, Dissecting Scissors  
 Feine Präparierscheren, Präparierscheren  
 Tijeras finas de disección, Tijeras de disección  
 Ciseaux fins à dissection, Ciseaux à dissection  
 Forbici fini per dissezione, Forbici per dissezione

**Metzenbaum-Fine Delicate Dissecting Scissor**  
 Curved, Blunt/Blunt, Slender Pattern

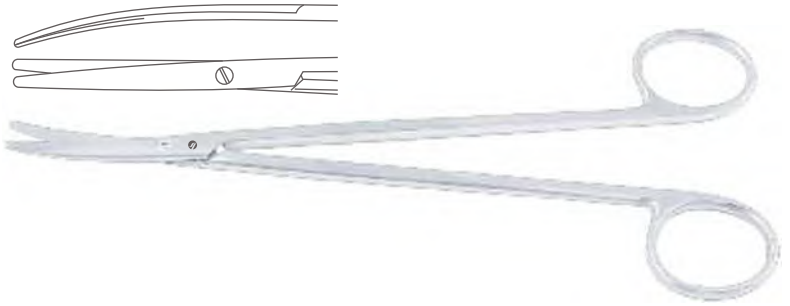

Catalog #	Size
SS-211-18	18 cm (7")
SS-211-20	20 cm (8")
SS-211-23	23 cm (9")

**Metzenbaum-Fine Delicate Dissecting Scissor**  
 Curved, Blunt/Blunt, Slender Pattern

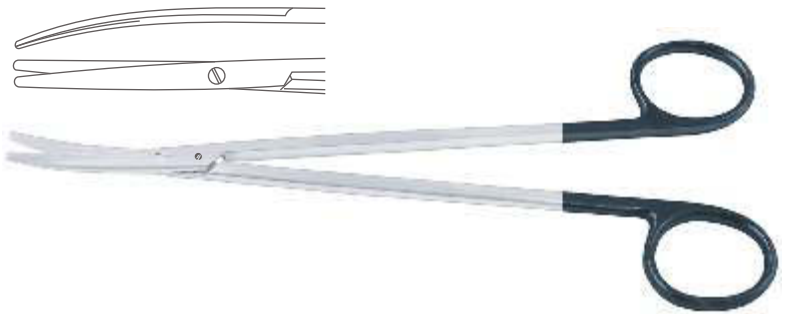

**SUPER Edge™**

Catalog #	Size
SS-211-18 SC	18 cm (7")
SS-211-20 SC	20 cm (8")
SS-211-23 SC	23 cm (9")

**Metzenbaum-Fine Delicate Dissecting Scissor**  
 Straight, Sharp/Sharp, Slender Pattern



Catalog #	Size
SS-214-18	18 cm (7")
SS-214-20	20 cm (8")
SS-214-23	23 cm (9")

**Metzenbaum-Fine Delicate Dissecting Scissor**  
 Straight, Sharp/Sharp, Slender Pattern



**SUPER Edge™**

Catalog #	Size
SS-214-18 SC	18 cm (7")
SS-214-20 SC	20 cm (8")
SS-214-23 SC	23 cm (9")



Delicate Dissecting Scissors, Dissecting Scissors  
Feine Präparierscheren, Präparierscheren  
Tijeras finas de disección, Tijeras de disección  
Ciseaux fins à dissection, Ciseaux à dissection  
Forbici fini per dissezione, Forbici per dissezione

**Metzenbaum-Fine Delicate Dissecting Scissor**  
Curved, Sharp/Sharp, Slender Pattern

Catalog #	Size
SS-215-18	18 cm (7")
SS-215-20	20 cm (8")
SS-215-23	23 cm (9")



**Metzenbaum-Fine Delicate Dissecting Scissor**  
Curved, Sharp/Sharp, Slender Pattern

**SUPER Edge™**

Catalog #	Size
SS-215-18 SC	18 cm (7")
SS-215-20 SC	20 cm (8")
SS-215-23 SC	23 cm (9")



**Metzenbaum-Fine Delicate Dissecting Scissor**  
Curved, S Shaped

Catalog #	Size
SS-219-18	18 cm (7")
SS-219-20	20 cm (8")
SS-219-23	23 cm (9")

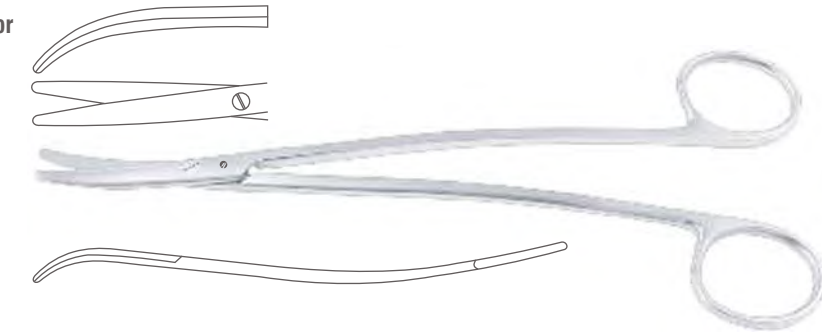

**Salzer Cleft Palate Dissecting Scissor**  
Curved, Fine Pattern

Catalog #	Size
SS-223-12	12.5 cm (5")
SS-223-18	18 cm (7")





Dissecting Scissors, Face-lift Scissors  
Präparierscheren, Face-lift-Scheren  
Tijeras de disección, Tijeras para Face-Lift  
Ciseaux à dissection, Ciseaux pour Face-lift  
Forbici per dissezione, Forbici per Face-lift

**Sanvenero Dissecting Scissor**  
Straight

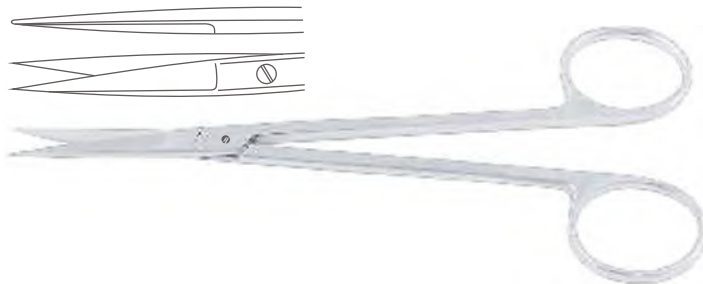

Catalog #	Size
SS-226-14	14 cm (5 1/2")

**Sanvenero Dissecting Scissor**  
Curved

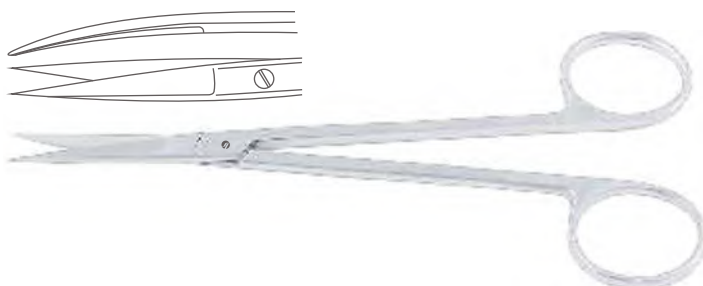

Catalog #	Size
SS-227-14	14 cm (5 1/2")

**Tenotomy Scissor**  
Straight



Catalog #	Size
SS-230-11	11.5 cm (4 1/2")

**Tenotomy Scissor**  
Curved

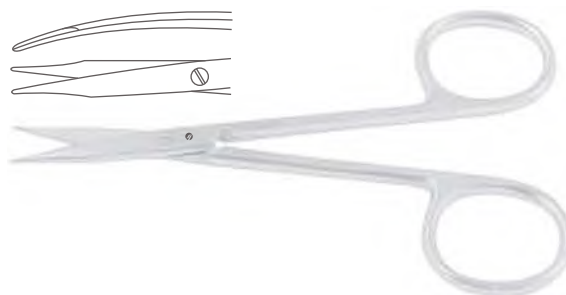

Catalog #	Size
SS-231-11	11.5 cm (4 1/2")

**Peck-Joseph Face-Lift Scissor**  
Straight, Sharp/Sharp



Catalog #	Size
SS-236-14	14.5 cm (5 3/4")

INCHES  
MILLIMETERS





Face-lift Scissors, Dissecting Scissors  
Face-lift-Scheren, Präparierscheren  
Tijeras para Face-Lift, Tijeras de disección  
Ciseaux pour Face-lift, Ciseaux à dissection  
Forbici per Face-lift, Forbici per dissezione

**Peck-Joseph Face-Lift Scissor**  
Curved, Sharp/Sharp

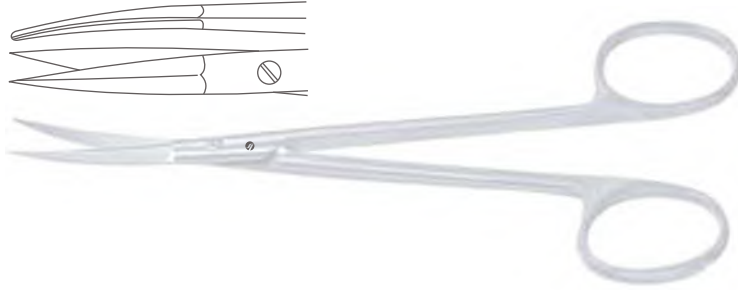

Catalog #	Size
SS-237-14	14.5 cm (5 ¾")

**Peck-Joseph Face-Lift Scissor**  
Straight, Blunt/Blunt

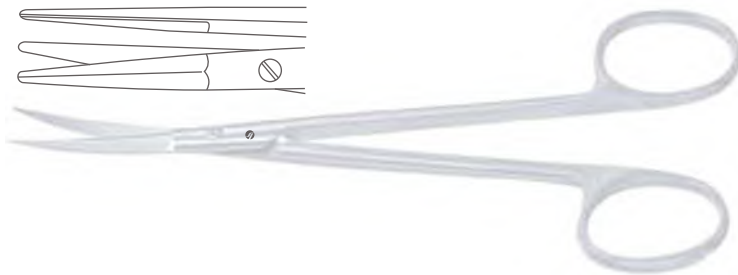

Catalog #	Size
SS-238-14	14.5 cm (5 ¾")

**Peck-Joseph Face-Lift Scissor**  
Curved, Blunt/Blunt



Catalog #	Size
SS-239-14	14.5 cm (5 ¾")

**Shea Vein Graft Scissor**  
Curved



Catalog #	Size
SS-241-12	12 cm (4 ¾")

**Ragnell (Kilner) Dissecting Scissor**  
Curved



Catalog #	Size
SS-243-12	12 cm (4 ¾")
SS-243-15	15 cm (6")
SS-243-18	18 cm (7")



Dissecting Scissors  
Präparierscheren  
Tijeras de disección  
Ciseaux à dissection  
Forbici per dissezione

**Nerve Dissecting Scissor**  
Curved, Semi Sharp

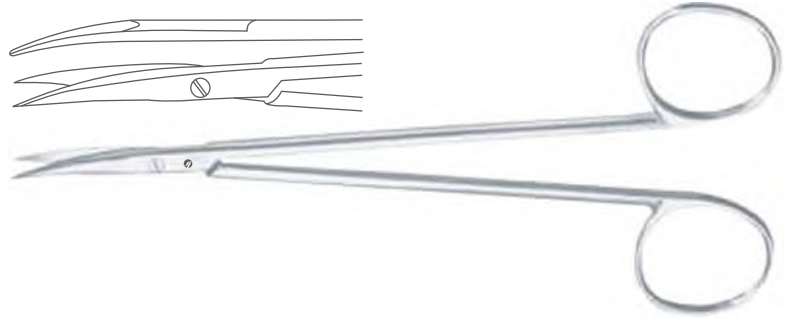

Catalog #	Size
SS-245-15	15 cm (6")

**Dissecting Scissor**  
Straight

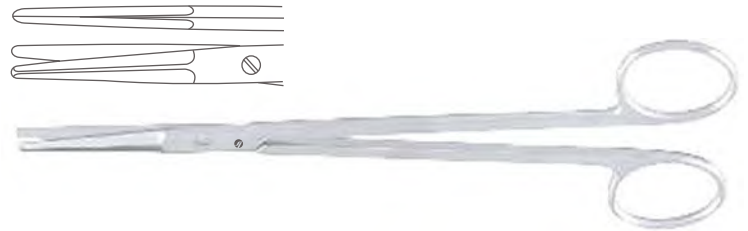

Catalog #	Size
SS-248-14	14.5 cm (5 3/4")

**Dissecting Scissor**  
Curved



Catalog #	Size
SS-249-14	14.5 cm (5 3/4")

**Reynolds Dissecting Scissor**  
Straight

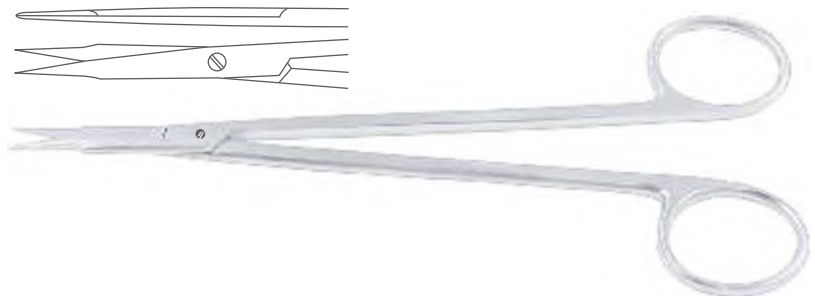

Catalog #	Size
SS-250-15	15.5 cm (6")
SS-250-18	18 cm (7")

**Reynolds Dissecting Scissor**  
Straight

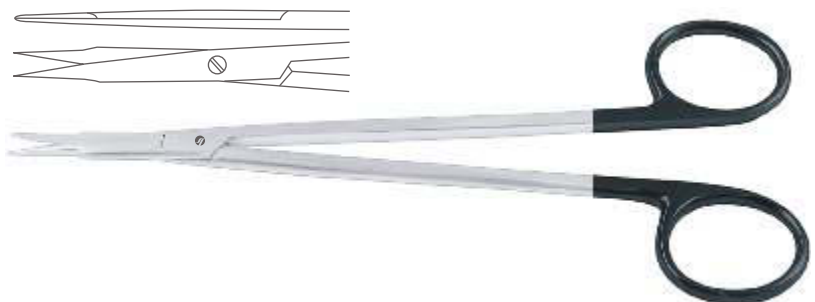

**SUPER Edge™**

Catalog #	Size
SS-250-15 SC	15.5 cm (6")
SS-250-18 SC	18 cm (7")





Dissecting Scissors  
Präparierscheren  
Tijeras de disección  
Ciseaux à dissection  
Forbici per dissezione

**Reynolds Dissecting Scissor**  
Curved

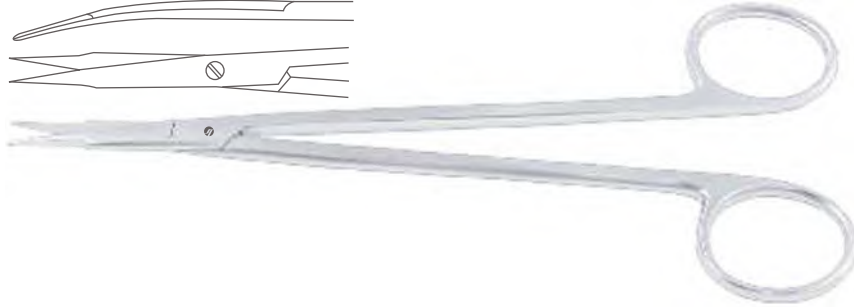

Catalog #	Size
SS-251-15	15.5 cm (6")
SS-251-18	18 cm (7")

**Reynolds Dissecting Scissor**  
Curved

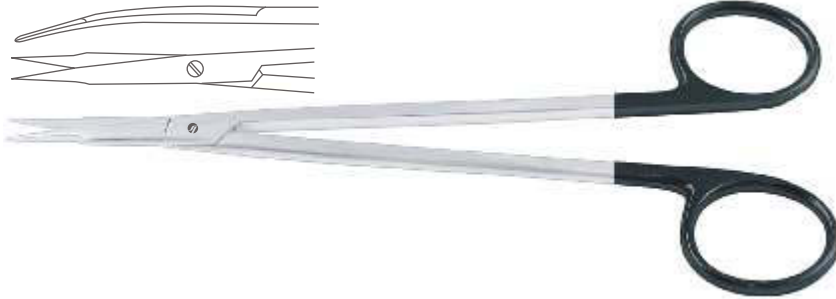

Catalog #	Size
SS-251-15 SC	15.5 cm (6")
SS-251-18 SC	18 cm (7")

**Jameson Dissecting Scissor**  
Curved

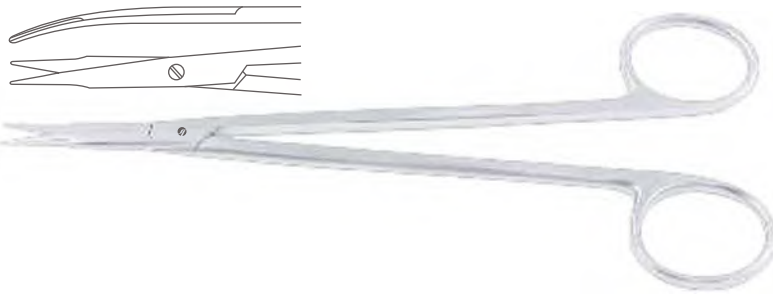

Catalog #	Size
SS-253-15	15.5 cm (6")

**Jameson Dissecting Scissor**  
Curved

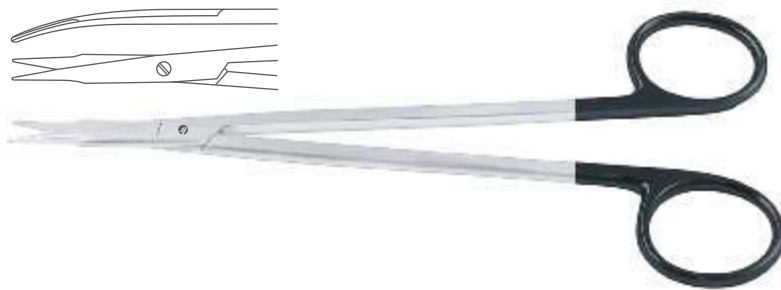

**SUPER Edge™**

Catalog #	Size
SS-253-15 SC	15.5 cm (6")

**Jameson-Werber Dissecting Scissor**  
Curved

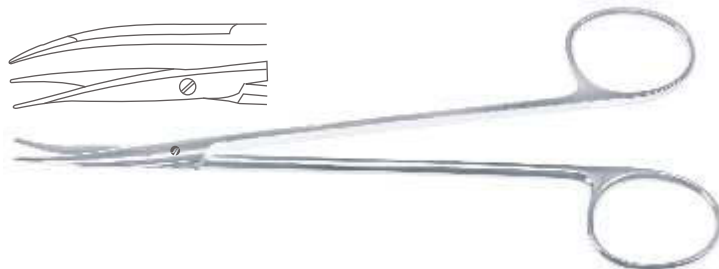

Catalog #	Size
SS-257-13	13 cm (5")



Dissecting Scissors, Vascular Scissors  
Präparierscheren, Gefäßscheren  
Tijeras de disección, Tijeras vasculares  
Ciseaux à dissection, Ciseaux vasculaires  
Forbici per dissezione, Forbici vascolari

**Potts Dissecting Scissor**  
Curved

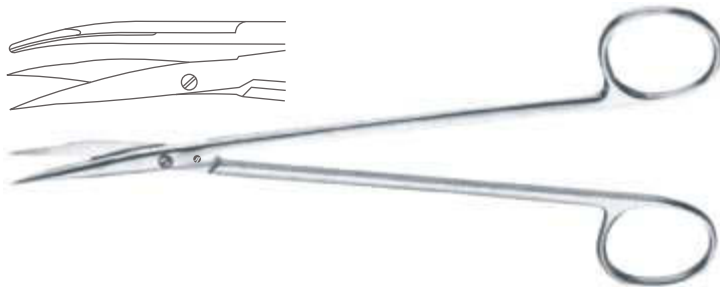

Catalog #	Size
SS-259-18	18 cm (7")

**DeBakey Arteriotomy Scissor**  
Curved

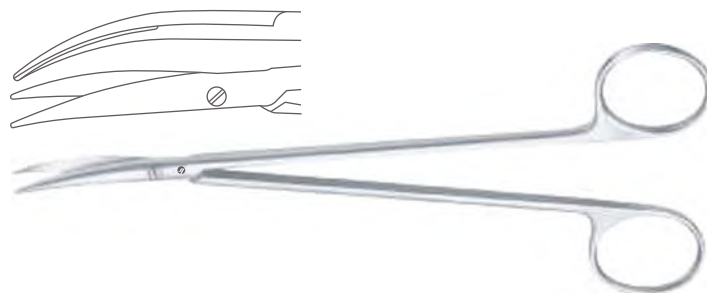

Catalog #	Size
SS-261-17	17.5 cm (7")

**Vascular Scissor**  
Straight

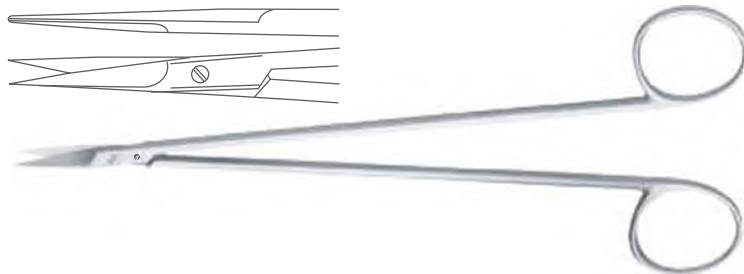

Catalog #	Size
SS-264-19	19 cm (7 1/2")

**Vascular Scissor**  
Curved

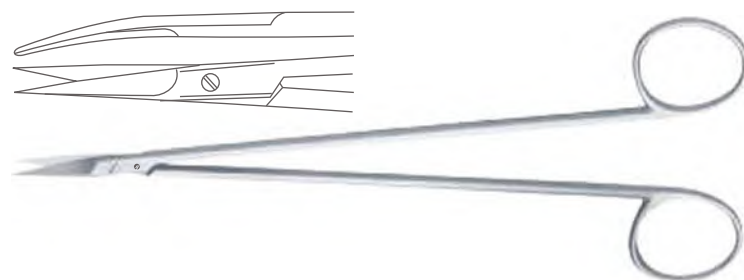

Catalog #	Size
SS-265-19	19 cm (7 1/2")

**Satinsky Thoracic Scissor**  
Curved

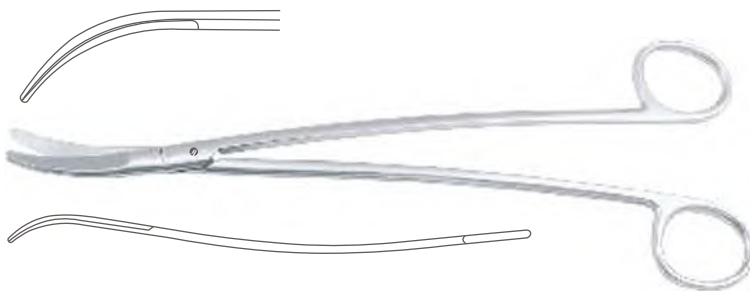

Catalog #	Size
SS-267-24	25.5 cm (10")



Vascular Scissors  
Gefäßscheren  
Tijeras vasculares  
Ciseaux vasculaires  
Forbici vascolari

**Diethrich-Salyer Cleft Palate Dissecting Scissor**  
Angled

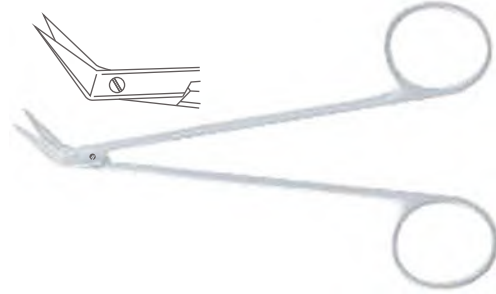

Catalog #	Size
SS-269-12	12 cm (4 3/4")

**Diethrich Vascular Scissor**  
Angled 125°, With Guide



Catalog #	Size
SS-275-00	17.5 cm (7")

**DeBakey Vascular Scissor**  
Angled 45°



Catalog #	Size
SS-277-45	16.5 cm (6 1/2")

**DeBakey Vascular Scissor**  
Angled 60°



Catalog #	Size
SS-277-60	16cm (6 1/4")

**Potts-Smith Vascular Scissor**  
Angled 60°, With Probe Tip



Catalog #	Size
SS-279-19	18 cm (7")



Vascular Scissors  
Gefäßscheren  
Tijeras vasculares  
Ciseaux vasculaires  
Forbici vascolari

**Potts-Smith Vascular Scissor**  
Angled 25°

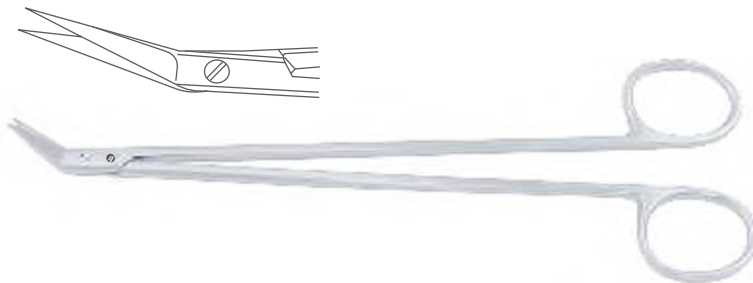

Catalog #	Size
SS-281-25	18 cm (7")

**Potts-Smith Vascular Scissor**  
Angled 25°

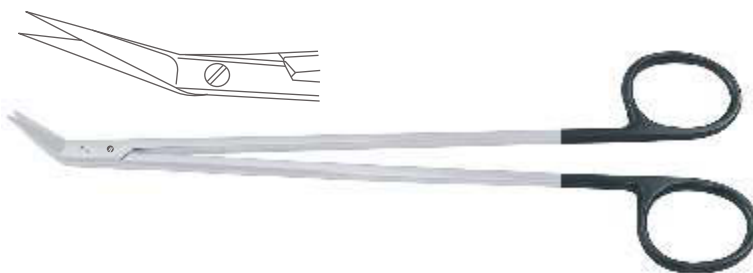

Catalog #	Size
SS-281-25 SC	18 cm (7")

**Potts-Smith Vascular Scissor**  
Angled 45°



Catalog #	Size
SS-281-45	18.5 cm (7 1/4")

**Potts-Smith Vascular Scissor**  
Angled 45°



Catalog #	Size
SS-281-45 SC	18.5 cm (7 1/4")

**Potts-Smith Vascular Scissor**  
Angled 60°



Catalog #	Size
SS-281-60	18 cm (7")



Vascular Scissors  
Gefäßscheren  
Tijeras vasculares  
Ciseaux vasculaires  
Forbici vascolari

SS

SCISSORS

**Potts-Smith Vascular Scissor**  
Angled 60°

Catalog #	Size
SS-281-60 SC	18 cm (7")

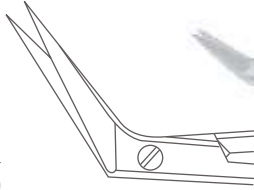

**Potts-Smith Vascular Scissor**  
Angled on Flat

Catalog #	Size
SS-283-19	18.5 cm (7 1/4")





Vascular Scissors  
Gefäßscheren  
Tijeras vasculares  
Ciseaux vasculaires  
Forbici vascolari

**Diethrich-Potts Vascular Scissor**  
Standard Blade



Catalog #	Size, Profile
SS-285-25	18 cm (7"), Angled 25°
SS-285-45	18 cm (7"), Angled 45°
SS-285-60	18 cm (7"), Angled 60°
SS-285-90	18 cm (7"), Angled 90°
SS-287-00	18 cm (7"), Angled 125°

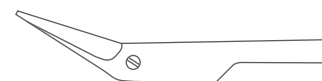

SS-285-25, Angled 25°



SS-285-45, Angled 45°



SS-285-60, Angled 60°

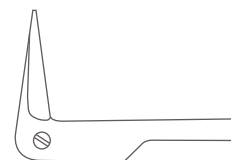

SS-285-90, Angled 90°

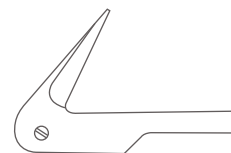

SS-287-00, Angled 125°



Vascular Scissors  
Gefäßscheren  
Tijeras vasculares  
Ciseaux vasculaires  
Forbici vascolari

**Diethrich-Potts Vascular Scissor**  
Delicate Blade

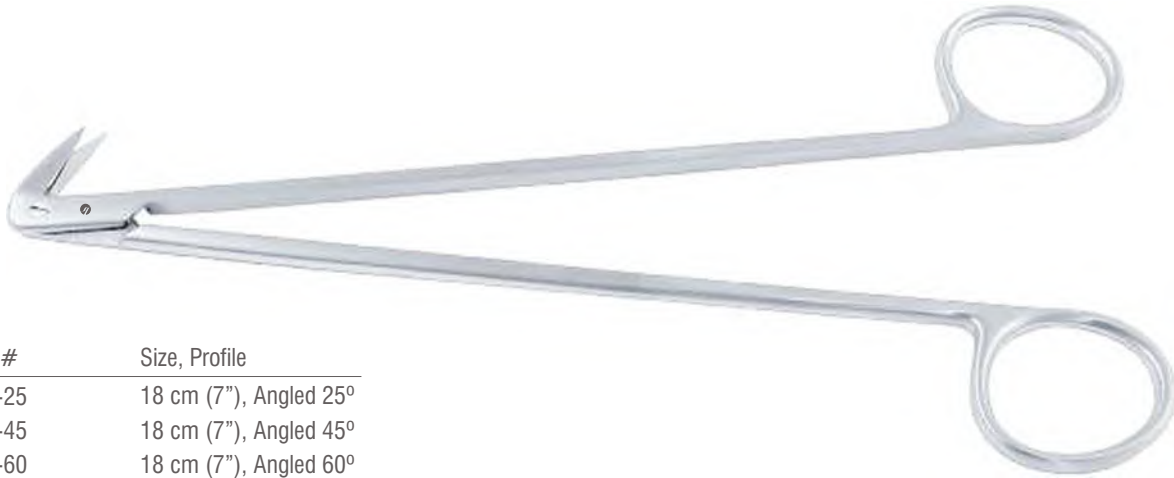

Catalog #	Size, Profile
SS-289-25	18 cm (7"), Angled 25°
SS-289-45	18 cm (7"), Angled 45°
SS-289-60	18 cm (7"), Angled 60°
SS-289-90	18 cm (7"), Angled 90°
SS-291-00	18 cm (7"), Angled 125°

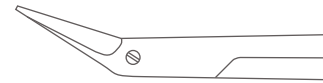

SS-289-25, Angled 25°

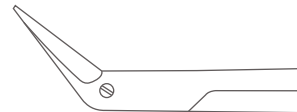

SS-289-45, Angled 45°

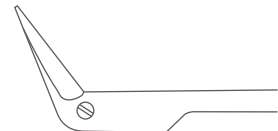

SS-289-60, Angled 60°

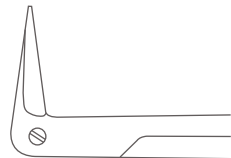

SS-289-90, Angled 90°

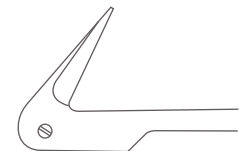

SS-291-00, Angled 125°



Vascular Scissors  
Gefäßscheren  
Tijeras vasculares  
Ciseaux vasculaires  
Forbici vascolari

**Diethrich-Potts Vascular Scissor**  
Ultra Delicate Blade

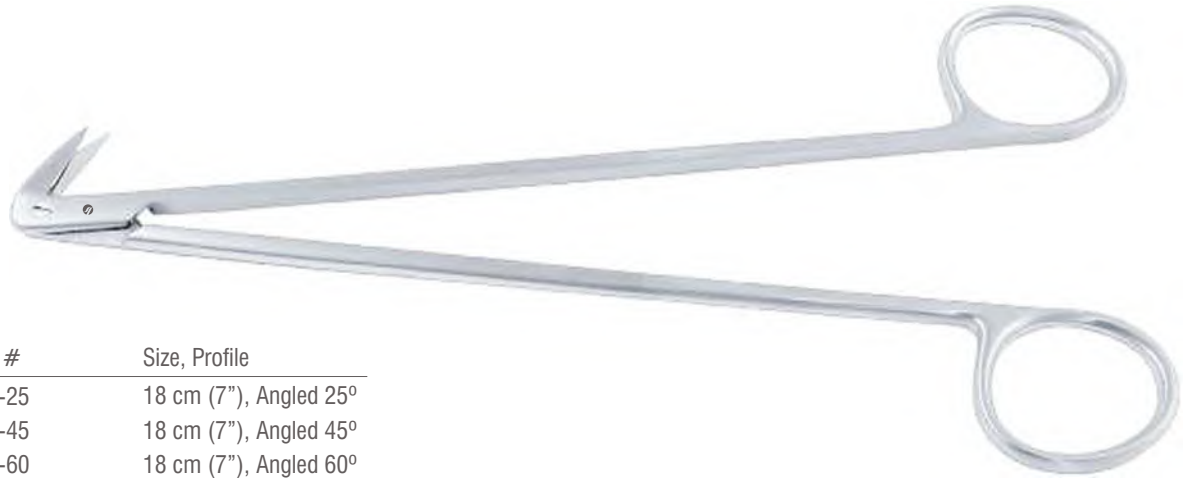

Catalog #	Size, Profile
SS-293-25	18 cm (7"), Angled 25°
SS-293-45	18 cm (7"), Angled 45°
SS-293-60	18 cm (7"), Angled 60°
SS-293-90	18 cm (7"), Angled 90°
SS-295-00	18 cm (7"), Angled 125°

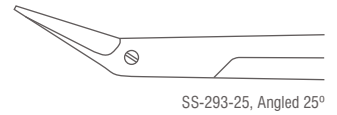

SS-293-25, Angled 25°

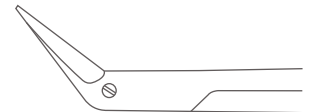

SS-293-45, Angled 45°

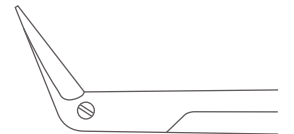

SS-293-60, Angled 60°

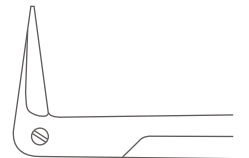

SS-293-90, Angled 90°

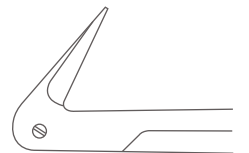

SS-295-00, Angled 125°





Vascular Scissors  
Gefäßscheren  
Tijeras vasculares  
Ciseaux vasculaires  
Forbici vascolari

**Potts-De Martel Cardiovascular Scissor**  
Angled 60°

Catalog #	Size
SS-299-22	22 cm (8 3/4")



**DeBakey Offset Scissor**  
S Shaped

Catalog #	Size
SS-301-16	15.5 cm (6")



**Favaloro Offset Scissor**  
Angled

Catalog #	Size
SS-303-15	15 cm (6")



**Vascular Scissor**  
One Blade Probe

Catalog #	Size
SS-306-12	12 cm (4 3/4")

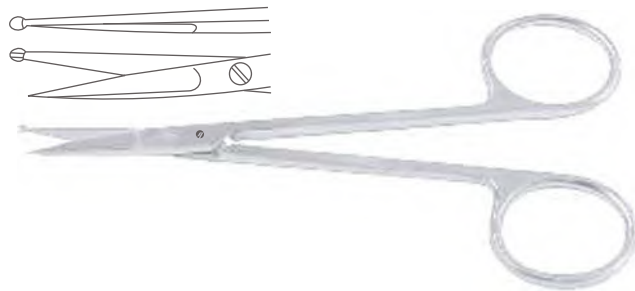

**Vascular Scissor**  
One Blade Probe

Catalog #	Size
SS-308-14	14.5 cm (5 3/4")

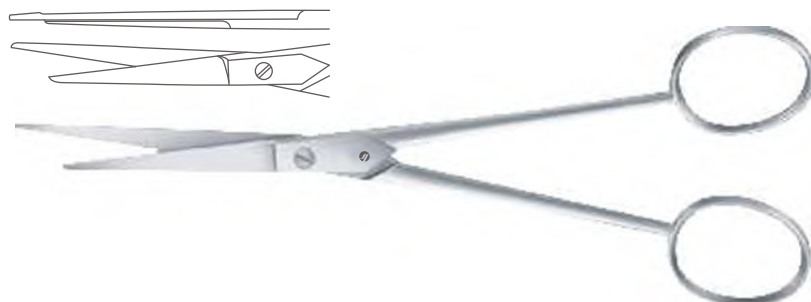



Vascular Scissors  
Gefäßscheren  
Tijeras vasculares  
Ciseaux vasculaires  
Forbici vascolari

**Strully Vascular Scissor**  
Curved

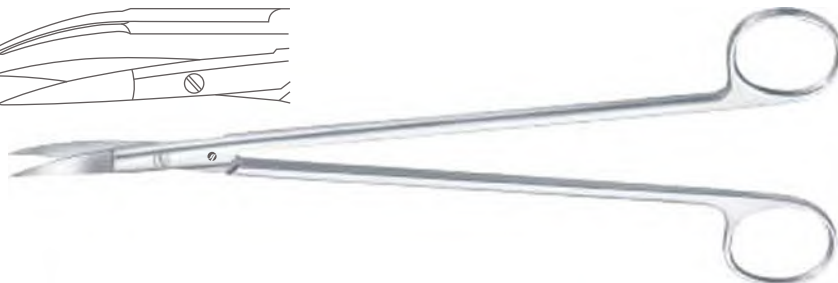
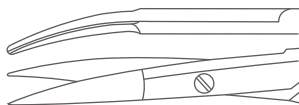

Catalog #	Size
SS-311-22	22 cm (8 3/4")

**Vascular Scissor**  
Straight

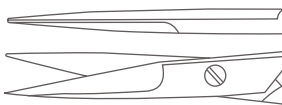

Catalog #	Size
SS-312-22	22.5 cm (8 3/4")

**Barre Vascular Scissor**  
Straight

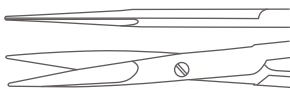

Catalog #	Size
SS-314-28	28 cm (11")

**Potts-Smith Vascular Scissor**  
Curved

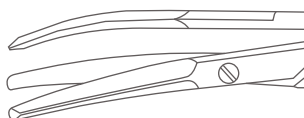

Catalog #	Size
SS-315-19	19 cm (7 1/2")

**Cooley Vascular Scissor**  
Curved

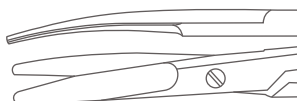

Catalog #	Size
SS-317-19	19 cm (7 1/2")



Vascular Scissors, Dissecting Scissors  
Gefäßscheren  
Tijeras vasculares, Tijeras de disección  
Ciseaux vasculaires, Ciseaux à dissection  
Forbici vascolari, Forbici per dissezione

**Klinkenberg-Loth Vascular Scissor**  
S Shaped

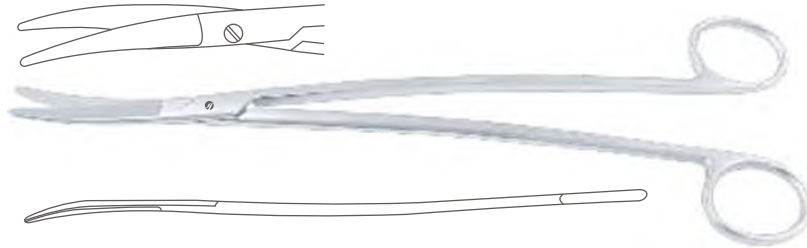

Catalog #	Size
SS-319-23	23 cm (9")

**Olivecrona Trigeminal Scissor**  
Toothed



Catalog #	Size, Working Le
SS-323-23	23 cm (9"), 120

**Strully Neurological Scissor**  
Curved



Catalog #	Size
SS-325-23	22.5 cm (8 3/4")

**Schmieden-Taylor Dissecting Scissor**  
One Blade Probed



Catalog #	Size
SS-327-17	16.5 cm (6 1/2")



Dissecting Scissors  
Präparierscheren  
Tijeras de disección  
Ciseaux à dissection  
Forbici per dissezione

**Toennis-Adson Dissecting Scissor**  
Curved



Catalog #	Size
SS-329-17	17.5 cm (7")

**Toennis Dissecting Scissor**  
Straight, Very Delicate

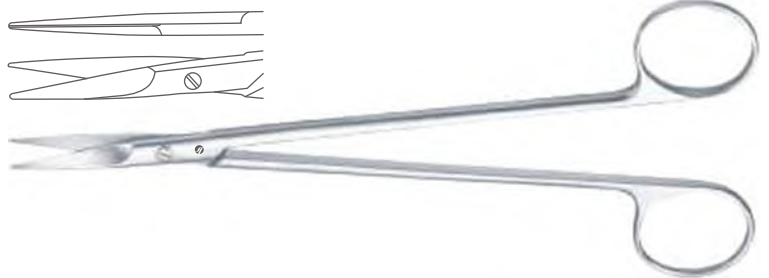

Catalog #	Size
SS-332-18	18 cm (7")

**Toennis Dissecting Scissor**  
Straight, Delicate



Catalog #	Size
SS-334-18	18 cm (7")

**Toennis Dissecting Scissor**  
Curved, Delicate

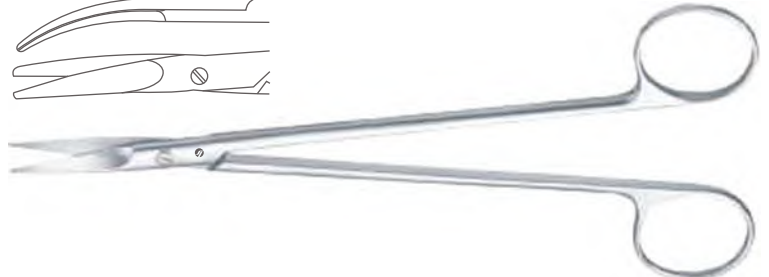

Catalog #	Size
SS-335-18	18 cm (7")

**Killian Bone Shear**



Catalog #	Size
SS-341-21	21 cm (8 1/4")



Tonsil and Nasal Scissors  
Tonsillen und Nasenscheren  
Tijeras para amígdalas, Tijeras nasales  
Ciseaux pour les amygdales, Ciseaux nasaux  
Forbici per tonsille, Forbici nasali

**Muehling Bone Shear**

Catalog #	Size
SS-343-21	21 cm (8 1/4")

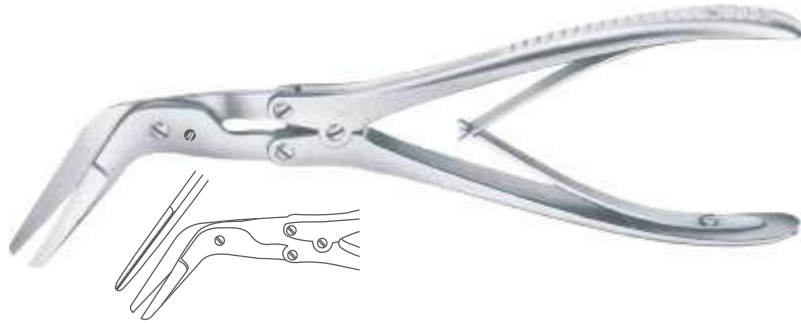

**Caplan Septum Scissor**  
One Toothed Cutting Edge

Catalog #	Size
SS-345-20	20 cm (8")



**Prince Tonsil Scissor**

Catalog #	Size
SS-347-18	18 cm (7")



**Dean Tonsil Scissor**  
Angled Upwards

Catalog #	Size
SS-351-17	17.5 cm (7")



**Dean Tonsil Scissor**  
Toothed, Angled Upwards

Catalog #	Size
SS-353-17	17.5 cm (7")





Tonsil and Nasal Scissors  
Tonsillen und Nasenscheren  
Tijeras para amígdalas, Tijeras nasales  
Ciseaux pour les amygdales, Ciseaux nasaux  
Forbici per tonsille, Forbici nasali

**Good Tonsil Scissor**



Catalog #	Size
SS-355-19	19.5 cm (7 3/4")

**Fomon Nasal Scissor**



Catalog #	Size
SS-357-15	15 cm (6")

**Fomon Nasal Scissor**

***SUPER Edge™***



Catalog #	Size
SS-357-15 SC	15 cm (6")

**Cottle Nasal Scissor**

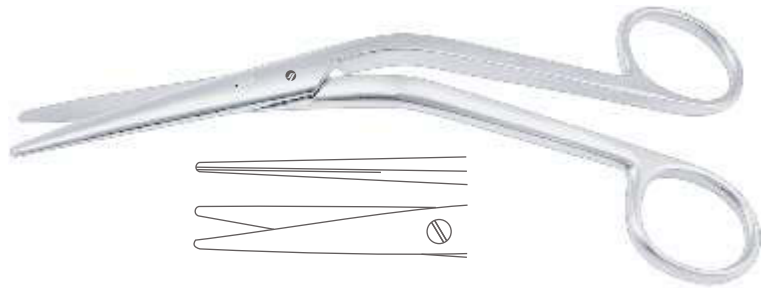

Catalog #	Size
SS-359-16	16 cm (6 1/4")

**Cottle Nasal Scissor**

***SUPER Edge™***



Catalog #	Size
SS-359-16 SC	16 cm (6 1/4")





Nasal Scissors, Episiotomy Scissors  
Nasenscheren, Episiotomiescheren  
Tijeras nasals, Tijeras para episiotomía  
Ciseaux nasaux, Ciseaux à épisiotomie  
Forbici nasali, Forbici per episiotomia

**Heymann Nasal Scissor**

Catalog #	Size
SS-361-18	18.5 cm (7 1/4")



**Heymann Nasal Scissor**

Catalog #	Size
SS-361-18 SC	18.5 cm (7 1/4")



**Heymann Nasal Scissor**  
One Toothed Cutting Edge

Catalog #	Size
SS-363-18	18.5 cm (7 1/4")



**Converse (Graefe) Nasal Scissor**  
Angled, Blunt/Blunt

Catalog #	Size
SS-367-11	10.5 cm (4 1/4")



**Converse Nasal Scissor**  
Angled, Sharp/Sharp

Catalog #	Size
SS-369-11	10.5 cm (4 1/4")





Nasal Scissors, Episiotomy Scissors, Umbilical Scissors  
 Nasenscheren, Episiotomiescheren, Nabelschnurscheren  
 Tijeras nasals, Tijeras para episiotomía, Tijeras umbilicales  
 Ciseaux nasaux, Ciseaux à épisiotomie, Ciseaux pour le cordon ombilical  
 Forbici nasali, Forbici per episiotomia, Forbici ombelicali

**Waldmann Nasal Scissor**  
 One Toothed Cutting Edge

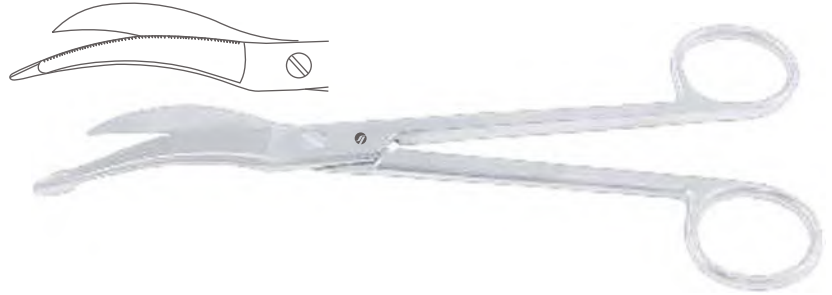

Catalog #	Size
SS-373-18	18 cm (7")

**Braun-Stadler Episiotomy Scissor**



Catalog #	Size
SS-381-14	14.5 cm (5 3/4")

**Braun-Stadler Episiotomy Scissor**



Catalog #	Size
SS-383-20	20 cm (8")
SS-383-22	22 cm (8 3/4")

**Modell USA Umbilical Cord Scissor**



Catalog #	Size
SS-385-10	10.5 cm (4 1/4")

**Schumacher Umbilical Cord Scissor**

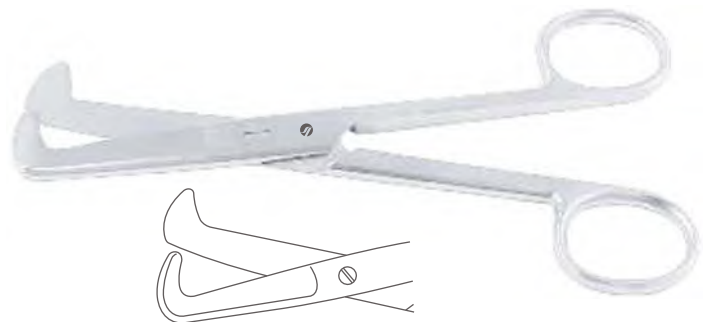

Catalog #	Size
SS-387-16	16 cm (6 1/4")





Umbilical Scissors, Gum Scissors  
Nabelschnurscheren, Zahnfleischscheren  
Tijeras umbilicales, Tijeras para encias  
Ciseaux pour le cordon ombilical, Ciseaux à gencives  
Forbici ombelicali, Forbici per gengiva

**Busch Umbilical Cord Scissor**

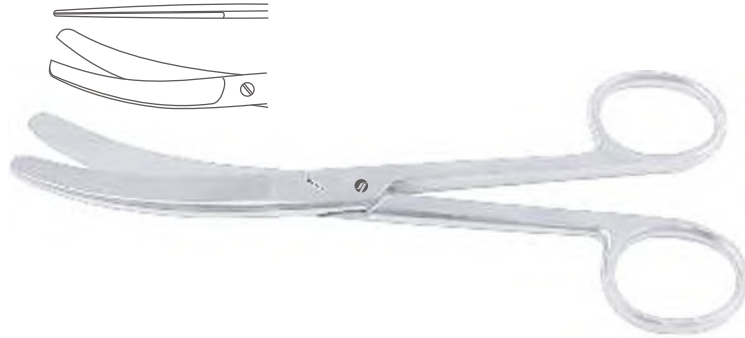

Catalog #	Size
SS-389-16	16 cm (6 1/4")

**Busch Umbilical Cord Scissor**  
One Toothed Cutting Edge

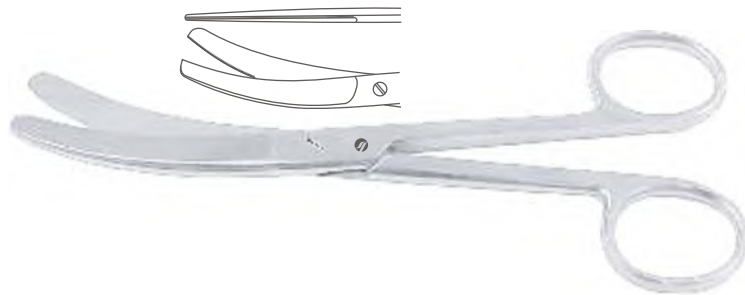

Catalog #	Size
SS-391-16	16 cm (6 1/4")

**Goldman-Fox Gum Scissor**  
Straight

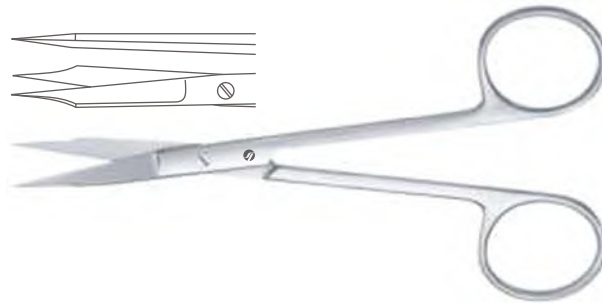

Catalog #	Size
SS-400-13	13 cm (5")

**Goldman-Fox Gum Scissor**  
Straight

**SUPER** *Edge*<sup>™</sup>



Catalog #	Size
SS-400-13 SC	13 cm (5")

**Goldman-Fox Gum Scissor**  
Curved

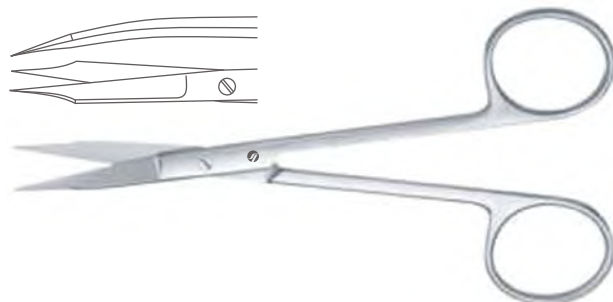

Catalog #	Size
SS-401-13	13 cm (5")



Gum Scissors, Operating Scissors  
Zahnfleischscheren, Chirurgische Scheren  
Tijeras para encías, Tijeras quirúrgicas  
Ciseaux à gencives, Ciseaux chirurgicaux  
Forbici per gengiva, Forbici per chirurgia

**Goldman-Fox Gum Scissor**  
Curved

**SUPER Edge™**

Catalog #	Size
SS-401-13 SC	13 cm (5")

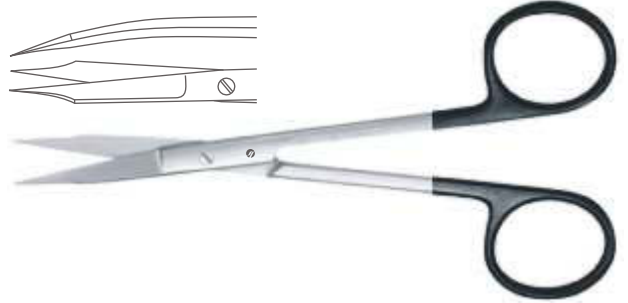

**Wagner Operating Scissor**  
Straight

Catalog #	Size
SS-402-12	12 cm (4 3/4")



**Wagner Operating Scissor**  
Straight

**SUPER Edge™**

Catalog #	Size
SS-402-12 SC	12 cm (4 3/4")



**Wagner Operating Scissor**  
Curved

Catalog #	Size
SS-403-12	12 cm (4 3/4")



**Wagner Operating Scissor**  
Curved

**SUPER Edge™**

Catalog #	Size
SS-403-12 SC	12 cm (4 3/4")





Operating Scissors, Gum Scissors  
Chirurgische Scheren, Zahnfleischscheren  
Tijeras quirúrgicas, Tijeras para encías  
Ciseaux chirurgicaux, Ciseaux à gencives  
Forbici per chirurgia, Forbici per gengiva

**Fine Pattern Operating Scissor**  
Straight, Sharp/Blunt



Catalog #	Size
SS-406-12	12 cm (4 3/4")

**Fine Pattern Operating Scissor**  
Curved, Sharp/Blunt

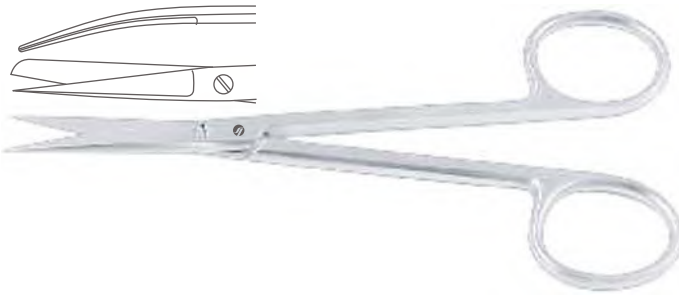

Catalog #	Size
SS-407-12	12 cm (4 3/4")

**Fine Pattern Operating Scissor**  
Straight, Sharp/Sharp



Catalog #	Size
SS-408-12	12 cm (4 3/4")

**Fine Pattern Operating Scissor**  
Curved, Sharp/Sharp



Catalog #	Size
SS-409-12	12 cm (4 3/4")

**La Grange Gum Scissor**  
S Shaped

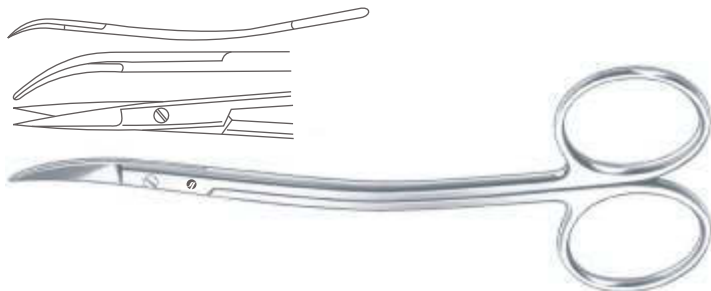

Catalog #	Size
SS-411-11	11.5 cm (4 1/2")



Gum Scissors, Operating Scissors  
Zahnfleischscheren, Chirurgische Scheren  
Tijeras para encías, Tijeras quirúrgicas  
Ciseaux à gencives, Ciseaux chirurgicaux  
Forbici per gengiva, Forbici per chirurgia

**Delicate Gum Scissor**  
Straight



Catalog #	Size
SS-414-11	11.5 cm (4 1/2")

**Delicate Gum Scissor**  
Curved



Catalog #	Size
SS-415-11	11.5 cm (4 1/2")

**Locklin Gum Scissor**  
Angled, One Toothed Cutting Edge

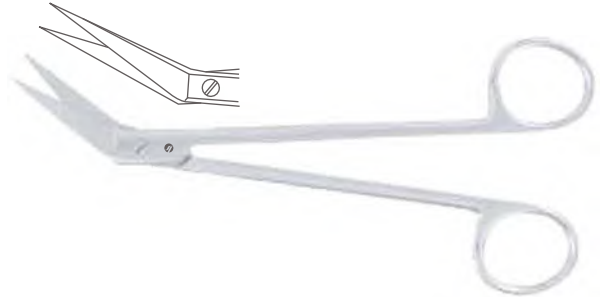

Catalog #	Size
SS-417-16	16 cm (6 1/4")

**Locklin Gum Scissor**  
Angled, S Shaped, One Toothed Cutting Edge

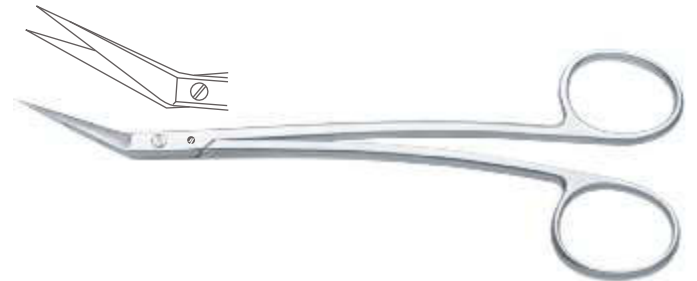

Catalog #	Size
SS-419-16	16 cm (6 1/4")

**Very Delicate Operating Scissor**  
Straight

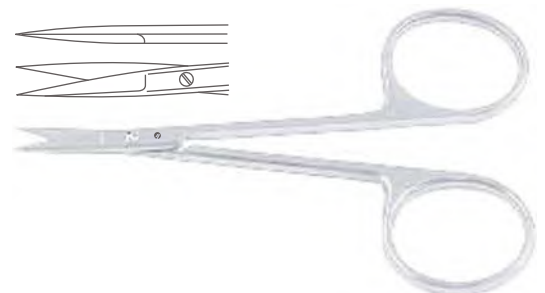

Catalog #	Size
SS-422-09	9 cm (3 1/2")



Operating Scissors, Iris Scissors  
Chirurgische Scheren, Irisscheren  
Tijeras quirúrgicas, Tijeras para iridectomía  
Ciseaux chirurgicaux, Ciseaux à iridectomie  
Forbici per chirurgia, Forbici per iridectomia

**Very Delicate Operating Scissor**  
Curved

Catalog #	Size
SS-423-09	9 cm (3 1/2")



**Iris Scissor**  
Straight

Catalog #	Size
SS-430-09	9 cm (3 1/2")
SS-430-10	10 cm (4")



**Iris Scissor**  
Curved

Catalog #	Size
SS-431-09	9 cm (3 1/2")
SS-431-10	10 cm (4")



**Iris Scissor**  
With Extra Flat Blades

Catalog #	Size
SS-432-10	10 cm (4")

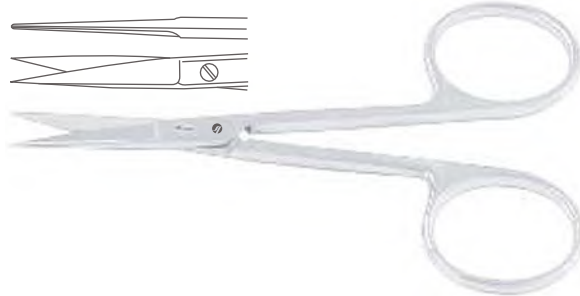

**Bonn Iris Scissor**  
Straight

Catalog #	Size
SS-434-09	9 cm (3 1/2")





Iris Scissors  
Irischeren  
Tijeras para iridectomía  
Ciseaux à iridectomie  
Forbici per iridectomia

**Bonn Iris Scissor**  
Curved

Catalog #	Size
SS-435-09	9 cm (3 1/2")



**Iris Scissor**  
Straight

Catalog #	Size
SS-440-11	11.5 cm (4 1/2")



**Iris Scissor**  
Straight

**SUPER Edge™**

Catalog #	Size
SS-440-11 SC	11.5 cm (4 1/2")

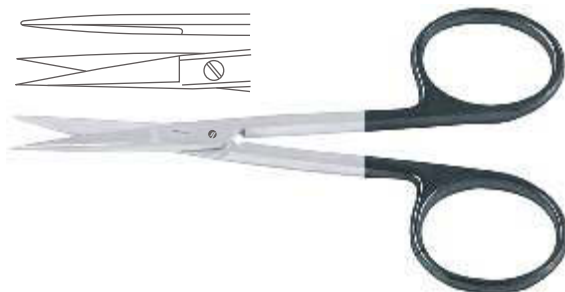

**Iris Scissor**  
Curved

Catalog #	Size
SS-441-11	11.5 cm (4 1/2")



**Iris Scissor**  
Curved

Catalog #	Size
SS-441-11 SC	11.5 cm (4 1/2")



INCHES  
MILLIMETERS





Iris Scissors  
Irisscheren  
Tijeras para iridectomia  
Ciseaux à iridectomie  
Forbici per iridectomia

SS

SCISSORS

**Iris Scissor**  
Curved to Side

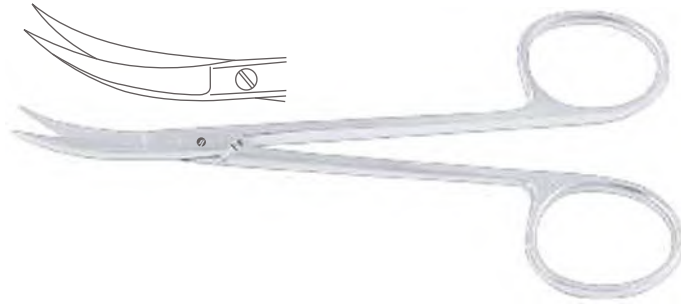

Catalog #	Size
SS-443-11	11.5 cm (4 1/2")

**Iris Scissor**  
Angled

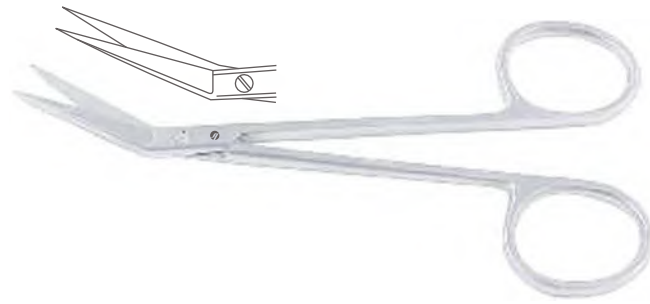

Catalog #	Size
SS-445-11	11.5 cm (4 1/2")

**Iris Scissor**  
Straight

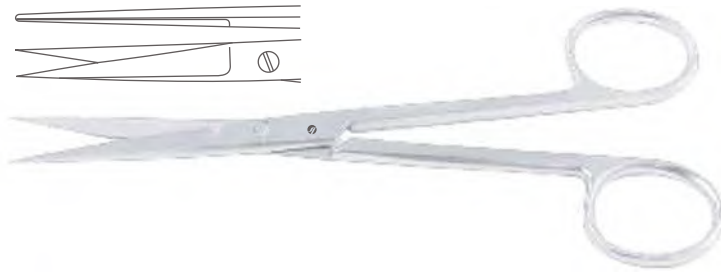

Catalog #	Size
SS-446-12	12.5 cm (5")

**Iris Scissor**  
Curved

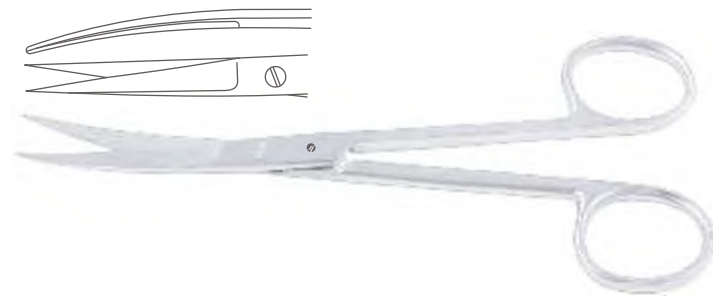

Catalog #	Size
SS-447-12	12.5 cm (5")

**Stevens Tenotomy Scissor**  
Straight, Sharp/Sharp

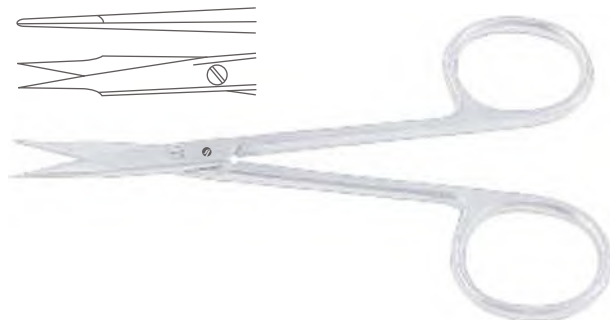

Catalog #	Size
SS-450-10	10 cm (4")
SS-450-11	11 cm (4 1/2")



Iris Scissors, Tendon Scissors  
 Irisscheren, Sehnenscheren  
 Tijeras para iridectomía, Tijeras para tendones  
 Ciseaux à iridectomie, Ciseaux à ténotomie  
 Forbici per iridectomia, Forbici per tenotomia

**Stevens Tenotomy Scissor**  
 Straight, Sharp/Sharp

**SUPER Edge™**

Catalog #	Size
SS-450-11 SC	11 cm (4 ½")

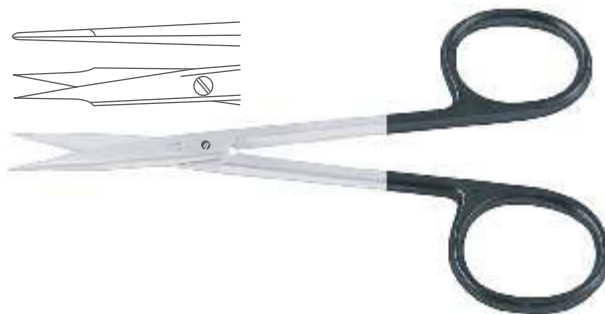

**Stevens Tenotomy Scissor**  
 Curved, Sharp/Sharp

Catalog #	Size
SS-451-10	10 cm (4")
SS-451-11	11 cm (4 ½")

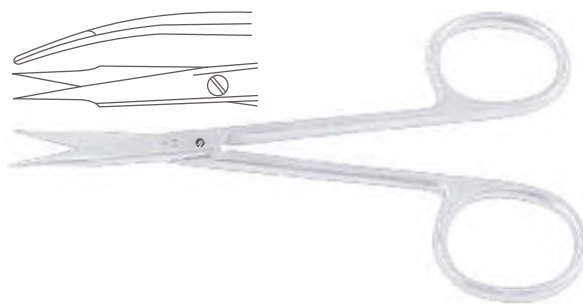

**Stevens Tenotomy Scissor**  
 Curved, Sharp/Sharp

**SUPER Edge™**

Catalog #	Size
SS-451-11 SC	11 cm (4 ½")

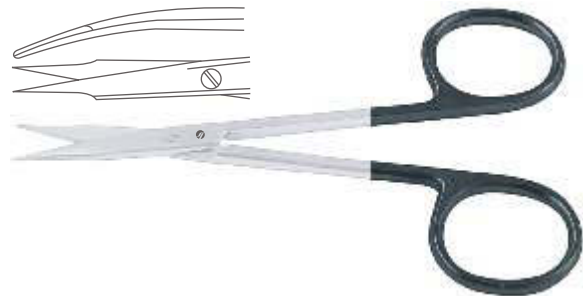

**Stevens Tenotomy Scissor**  
 Straight, Blunt/Blunt

Catalog #	Size
SS-452-10	10 cm (4")
SS-452-11	11 cm (4 ½")
SS-452-12	12.5 cm (5")

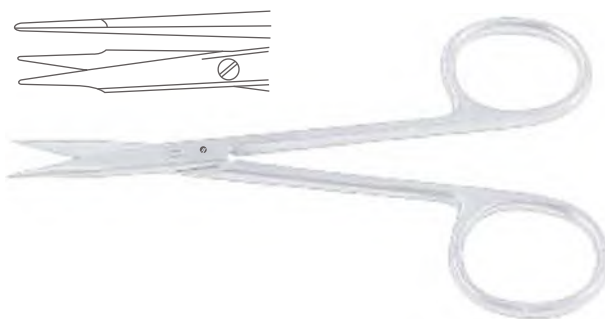

**Stevens Tenotomy Scissor**  
 Straight, Blunt/Blunt

**SUPER Edge™**

Catalog #	Size
SS-452-11 SC	11 cm (4 ½")

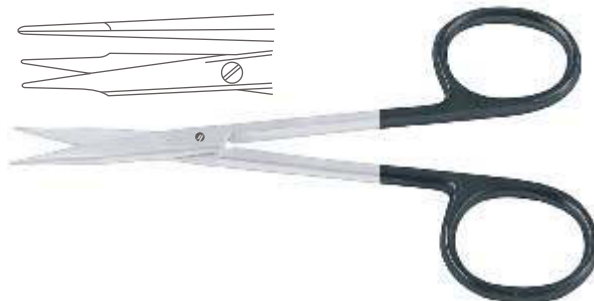

INCHES  
MILLIMETERS





Iris Scissors, Strabismus Scissors  
Irisscheren, Strabismusscheren  
Tijeras para iridectomia, Tijeras para estrabismo  
Ciseaux à iridectomie, Ciseaux à strabisme  
Forbici per iridectomia, Forbici per strabismo

**Stevens Tenotomy Scissor**  
Curved, Blunt/Blunt

Catalog #	Size
SS-453-10	10 cm (4")
SS-453-11	11 cm (4 1/2")
SS-453-12	12.5 cm (5")



**Stevens Tenotomy Scissor**  
Curved, Blunt/Blunt

**SUPER Edge™**

Catalog #	Size
SS-453-11 SC	11 cm (4 1/2")

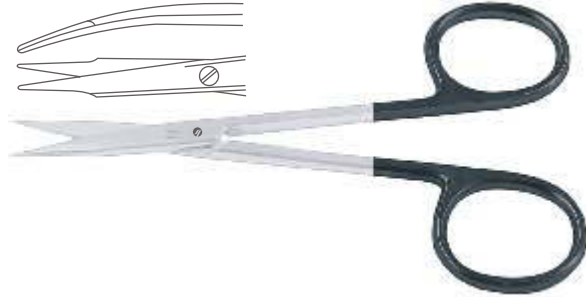

**Strabismus Scissor**  
Straight

Catalog #	Size
SS-456-11	11.5 cm (4 1/2")

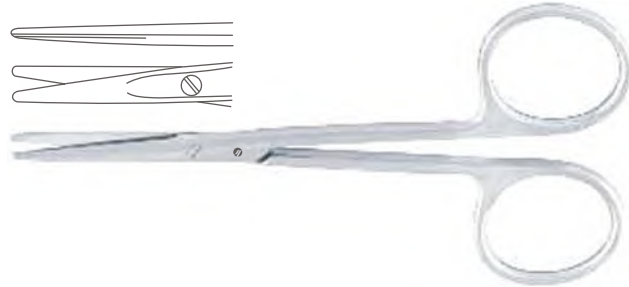

**Strabismus Scissor**  
Straight

**SUPER Edge™**

Catalog #	Size
SS-456-11 SC	11.5 cm (4 1/2")

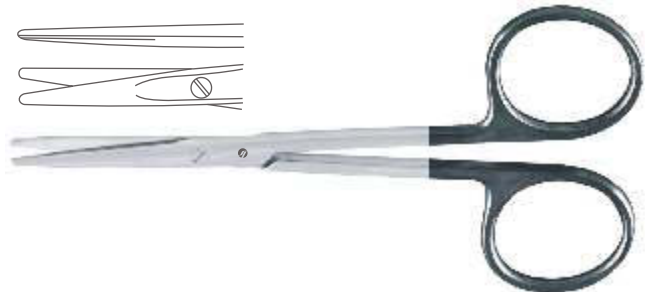

**Strabismus Scissor**  
Curved

Catalog #	Size
SS-457-11	11.5 cm (4 1/2")

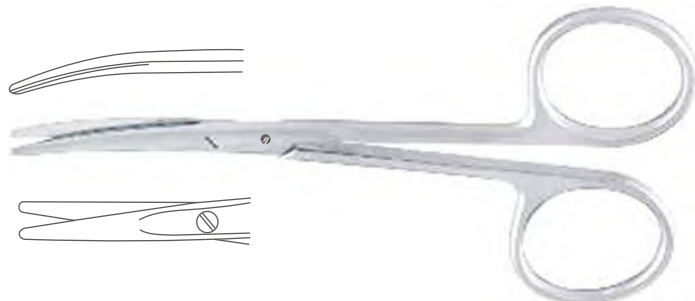



Strabismus Scissors, Dissecting Scissors  
Strabismusscheren, Präparierscheren  
Tijeras para estrabismo, Tijeras de disección  
Ciseaux à strabisme, Ciseaux à dissection  
Forbici per strabismo, Forbici per dissezione

**Strabismus Scissor**  
Curved

**SUPER Edge™**

Catalog #	Size
SS-457-11 SC	11.5 cm (4 1/2")

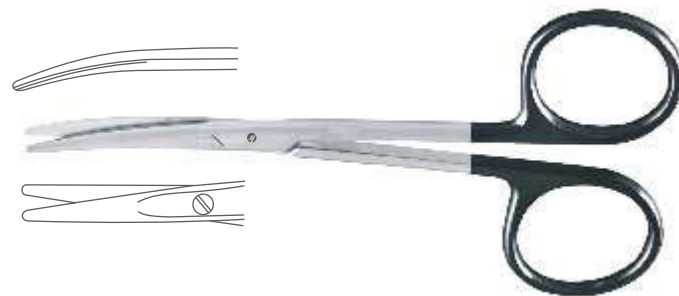

**Littler Dissecting Scissor**  
Curved, Tip With Eye For Suture

Catalog #	Size
SS-461-11	11.5 cm (4 1/2")

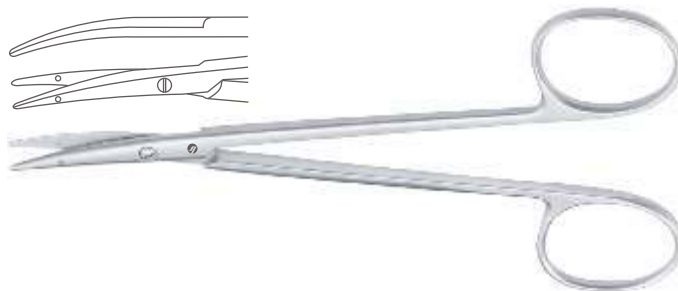

**Cottle Bulldog Scissor**  
Curved

Catalog #	Size
SS-463-11	11.5 cm (4 1/2")



**Kilner Delicate Dissecting Scissor**  
Straight

Catalog #	Size
SS-466-11	11.5 cm (4 1/2")



**Enucleation Scissor**  
Curved

Catalog #	Size
SS-469-11	11.5 cm (4 1/2")

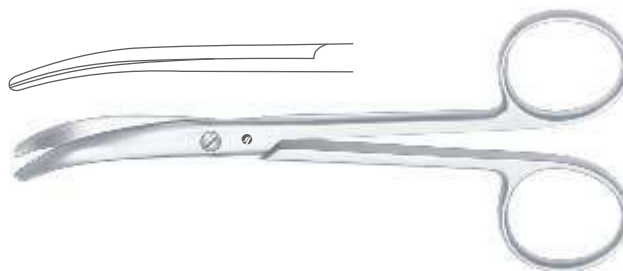



Dissecting Scissors, Face-lift Scissors  
Präparierscheren, Face-lift-Scheren  
Tijeras de disección, Tijeras para Face-Lift  
Ciseaux à dissection, Ciseaux pour Face-lift  
Forbici per dissezione, Forbici per Face-lift

**Chadwick Delicate Scissor**  
Curved

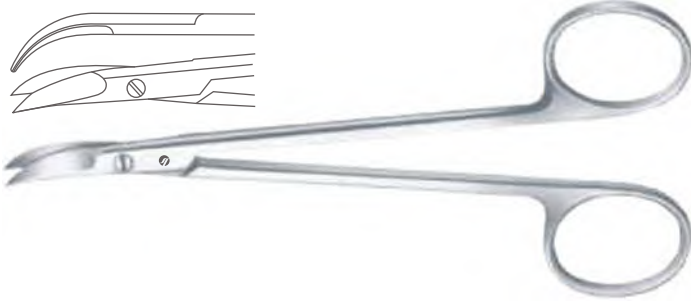

Catalog #	Size
SS-471-11	11.5 cm (4 1/2")

**Quimby Delicate Scissor**  
Curved



Catalog #	Size
SS-473-13	13 cm (5")

**Nerve Dissecting Scissor**  
Straight



Catalog #	Size
SS-476-11	11 cm (4 1/2")
SS-476-13	13 cm (5")

**Nerve Dissecting Scissor**  
Curved



Catalog #	Size
SS-477-11	11 cm (4 1/2")
SS-477-13	13 cm (5")

**Delicate Scissor**  
Angled

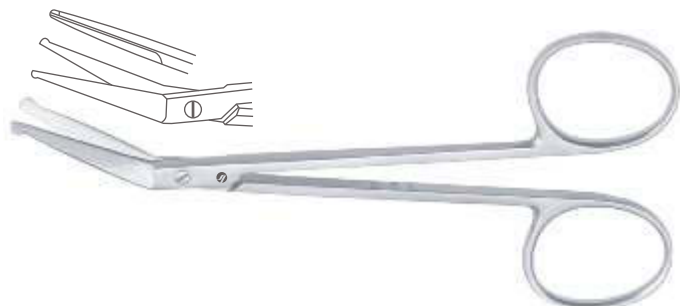

Catalog #	Size
SS-481-11	11.5 cm (4 1/2")



Face-lift Scissors  
Face-lift-Scheren  
Tijeras para Face-Lift  
Ciseaux pour Face-lift  
Forbici per Face-lift

**Ribbon Salyer Scissor**  
Straight, Flat Shanks

Catalog #	Size
SS-484-09	9.5 cm (3 3/4")

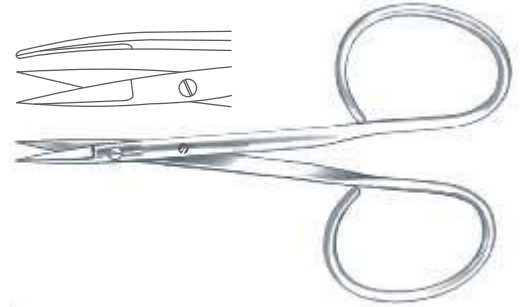

**Ribbon Iris Scissor**  
Straight, Sharp, Flat Shanks

Catalog #	Size
SS-486-09	9.5 cm (3 3/4")

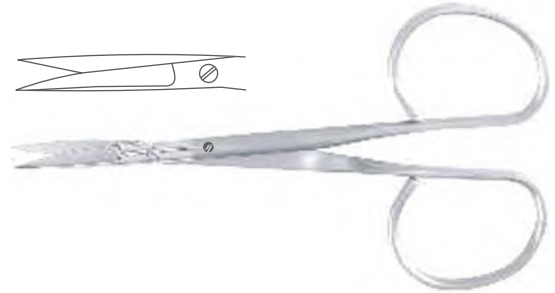

**Ribbon Iris Scissor**  
Curved, Sharp, Flat Shanks

Catalog #	Size
SS-487-09	9.5 cm (3 3/4")

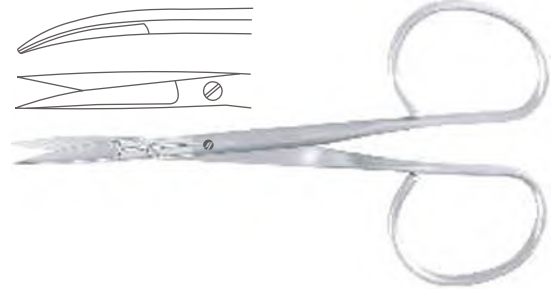

**Ribbon Iris Scissor**  
Straight, Blunt, Flat Shanks

Catalog #	Size
SS-488-10	10 cm (4")

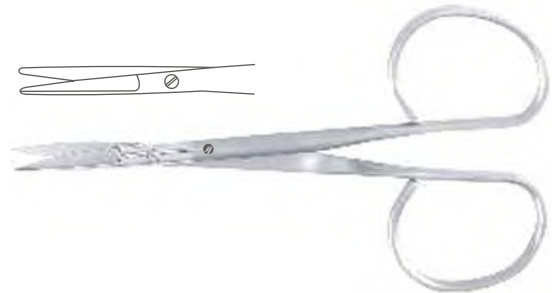

**Ribbon Iris Scissor**  
Curved, Blunt, Flat Shanks

Catalog #	Size
SS-489-10	10 cm (4")

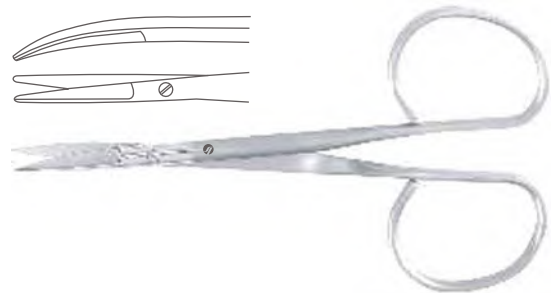



Face-lift Scissors  
Face-lift-Scheren  
Tijeras para Face-Lift  
Ciseaux pour Face-lift  
Forbici per Face-lift

**Ribbon Strabismus Scissor**  
Straight, Flat Shanks

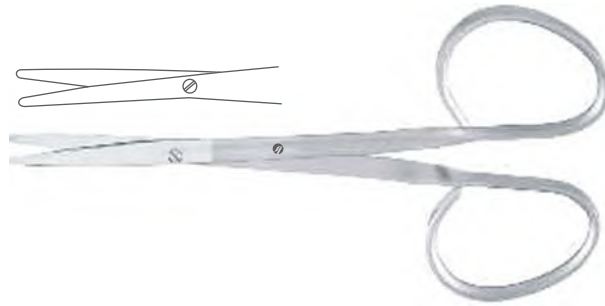

Catalog #	Size
SS-492-10	10 cm (4")

**Ribbon Strabismus Scissor**  
Curved, Flat Shanks

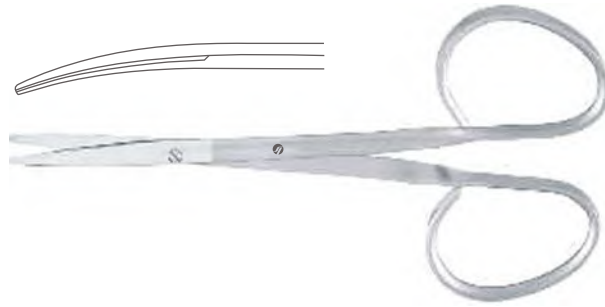

Catalog #	Size
SS-493-10	10 cm (4")

**Ribbon Stevens Tenotomy Scissor**  
Straight, Flat Shanks, Sharp Tips



Catalog #	Size
SS-496-10	10 cm (4")

**Ribbon Stevens Tenotomy Scissor**  
Curved, Flat Shanks, Sharp Tips



Catalog #	Size
SS-497-10	10 cm (4")

**Ribbon Stevens Tenotomy Scissor**  
Straight, Flat Shanks, Blunt Tips



Catalog #	Size
SS-498-10	10 cm (4")



Face-lift Scissors, Enterotomy Scissors  
Face-lift-Scheren, Darmscheren  
Tijeras para Face-Lift, Tijeras para intestino  
Ciseaux pour Face-lift, Ciseaux-entérotomes  
Forbici per Face-lift, Forbici per enterotomia

**Ribbon Stevens Tenotomy Scissor**  
Curved, Flat Shanks, Blunt Tips

Catalog #	Size
SS-499-10	10 cm (4")



**Ribbon Gradle Scissor**  
Straight, Flat Shanks

Catalog #	Size
SS-500-10	10 cm (4")



**Ribbon Gradle Scissor**  
Curved, Flat Shanks

Catalog #	Size
SS-501-10	10 cm (4")



**Ribbon Kaye Face-Lift Scissor**  
Curved, Flat Shanks, Toothed

Catalog #	Size
SS-507-11	11 cm (4 1/2")

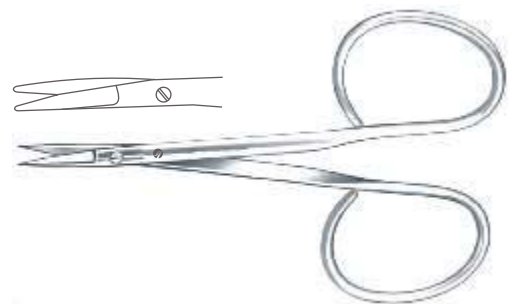

**Enterotomy Scissor**  
One Probe Tip

Catalog #	Size
SS-520-21	21.5 cm (8 1/2")

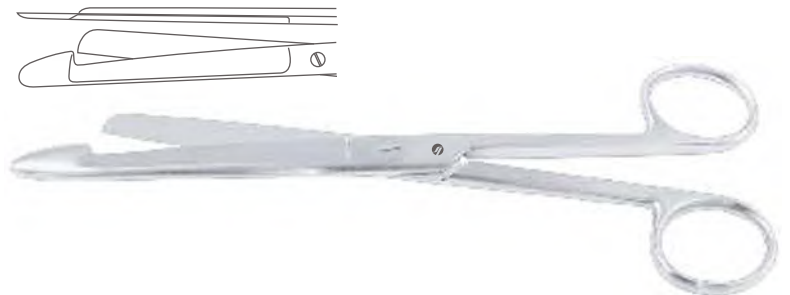





Rectal Scissors  
Rektumschere  
Tijera para recto  
Ciseaux pour rectum  
Forbici per il retto

**Enterotomy Scissor**  
One Probe Tip

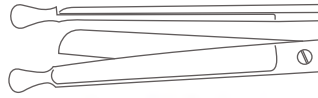

Catalog #	Size
SS-522-21	21.5 cm (8 1/2")

**Rectal Scissor**  
Curved, Heavy Pattern

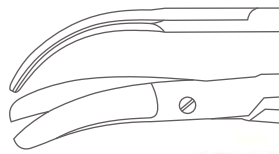

Catalog #	Size
SS-525-32	32.5 cm (12 3/4")

**Bowel Dissecting Scissor**  
Angled 60°

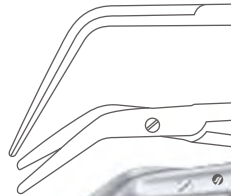

Catalog #	Size
SS-527-28	28 cm (11")

**Lloyd-Davies (Goligher) Rectal Scissor**  
Curved



Catalog #	Size
SS-529-27	27 cm (10 3/4")

**Stelzner Rectal Scissor**  
Straight



Catalog #	Size
SS-530-31	31 cm (12 1/4")



Rectal Scissors, Stitch Scissors  
Rektumschere, Fadenscheren  
Tijera para recto, Tijeras para hilos  
Ciseaux pour rectum, Ciseaux à ligatures  
Forbici per il retto, Forbici per legature

**Stelzner Rectal Scissor**  
Curved

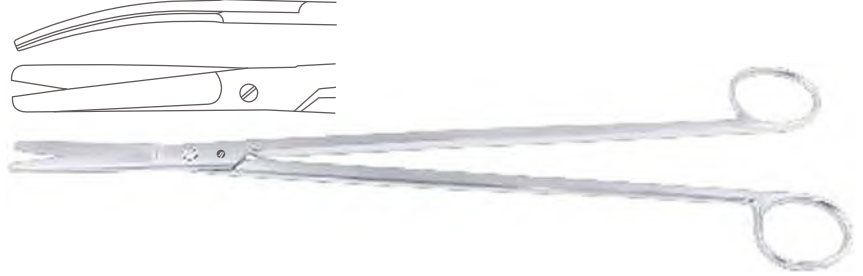

Catalog #	Size
SS-531-31	31 cm (12 1/4")

**Mueller Rectal Scissor**  
S Shaped

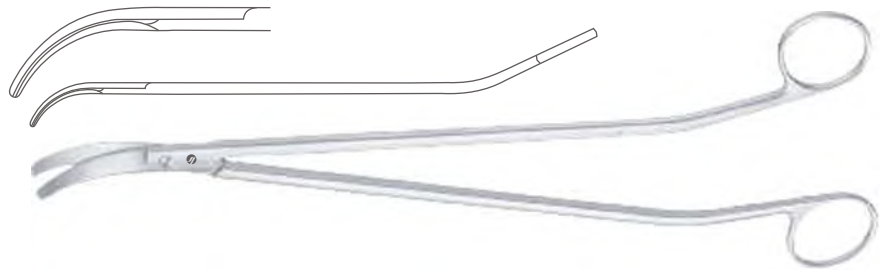

Catalog #	Size
SS-533-32	32.5 cm (12 3/4")

**Northbent Stitch Scissor**

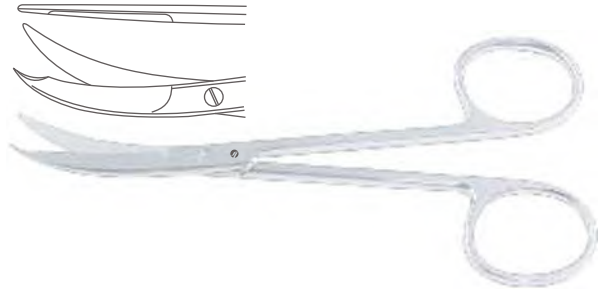

Catalog #	Size
SS-540-13	13 cm (5")

**Spencer Stitch Scissor**

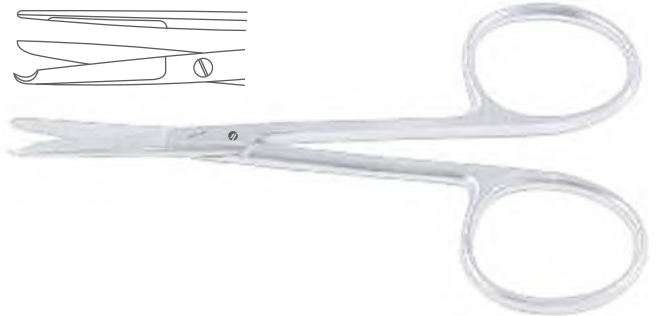

Catalog #	Size
SS-542-09	9 cm (3 1/2")
SS-542-13	13 cm (5")

**Buck Stitch Scissor**



Catalog #	Size
SS-544-14	14.5 cm (5 3/4")
SS-544-18	18 cm (7")





Stitch Scissors, Wire Cutting Scissors, Crown Scissors  
Fadenscheren, Drahtscheren, Kronenscheren  
Tijeras para hilos, Tijeras para cortar hilos de acero, Tijeras para coronas  
Ciseaux à ligatures, Ciseaux coupe-fil, Ciseaux à couronnes  
Forbici per legature, Forbici per tagliare fili metallic, Forbici per corone

**Littauer Stitch Scissor**



Catalog #	Size
SS-546-14	14 cm (5 1/2")

**Eiselberg Stitch Scissor**



Catalog #	Size
SS-548-12	12 cm (4 3/4")

**Universal Wire Cutting Scissor**  
Angled, One Toothed Cutting Edge



Catalog #	Size
SS-551-12	12 cm (4 3/4")

**Harvey Wire Cutting Scissor**  
Straight, One Toothed Cutting Edge

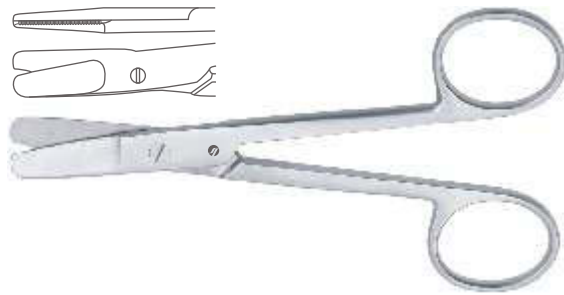

Catalog #	Size
SS-554-12	12.5 cm (5")

**Beebee Crown Scissor**  
Straight

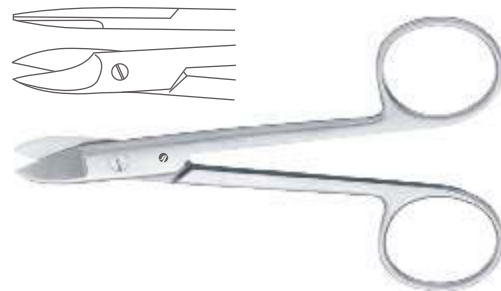

Catalog #	Size
SS-556-10	10.5 cm (4 1/4")



Crown Scissors, Nail Scissors  
Kronenscheren, Nagelscheren  
Tijeras para coronas, Tijeras para uñas  
Ciseaux à couronnes, Ciseaux à ongles  
Forbici per corone, Forbici per unghie

**Beebee Crown Scissor**  
Curved

Catalog #	Size
SS-557-10	10.5 cm (4 1/4")

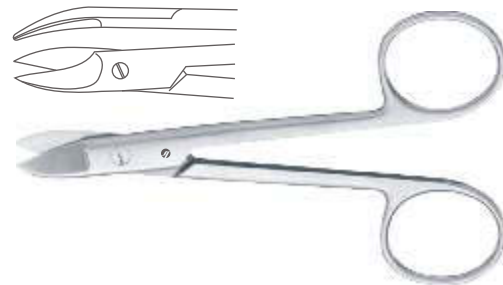

**Beebee Crown Scissor**  
Straight, One Toothed Cutting Edge

Catalog #	Size
SS-558-12	12 cm (4 3/4")

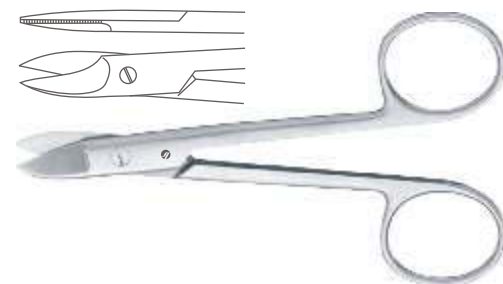

**Beebee Crown Scissor**  
Curved, One Toothed Cutting Edge

Catalog #	Size
SS-559-12	12 cm (4 3/4")

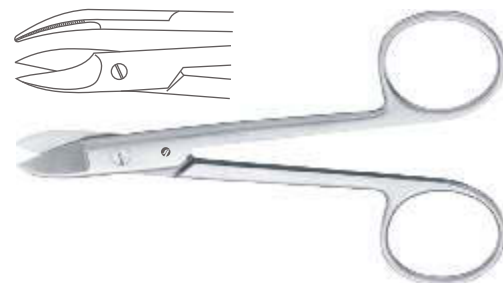

**Nail Scissor**

Catalog #	Size
SS-571-09	9 cm (3 1/2")



**Nail Scissor**  
Delicate Pattern

Catalog #	Size
SS-573-09	9 cm (3 1/2")

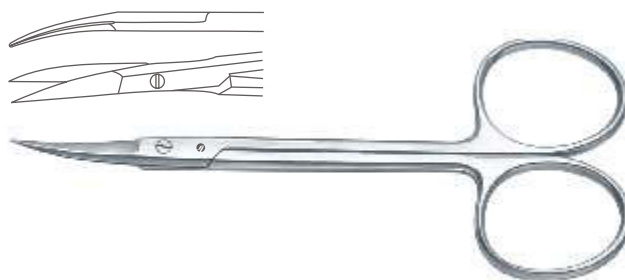



Nail Scissors  
Nagelscheren  
Tijeras para uñas  
Ciseaux à ongles  
Forbici per unghie

**Nail Scissor**

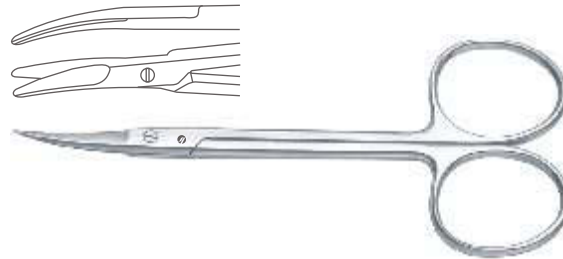

Catalog #	Size
SS-575-09	8.5 cm (3 1/4")

**Nail Scissor  
Straight**

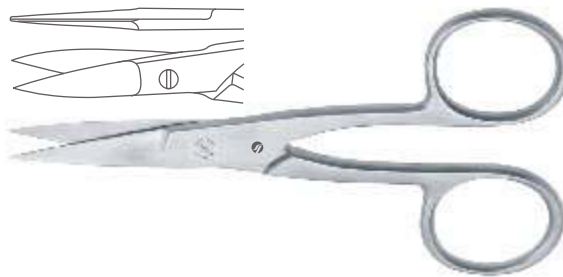

Catalog #	Size
SS-576-09	9 cm (3 1/2")

**Nail Scissor  
Curved**



Catalog #	Size
SS-577-09	9 cm (3 1/2")
SS-577-10	10 cm (4")
SS-577-11	11 cm (4 1/2")

**Nail Scissor  
Straight**

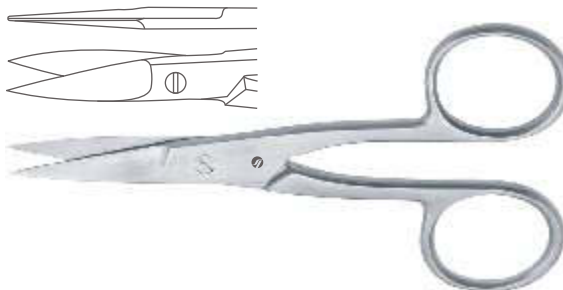

Catalog #	Size
SS-578-09	9.5 cm (3 3/4")

**Nail Scissor  
Curved**

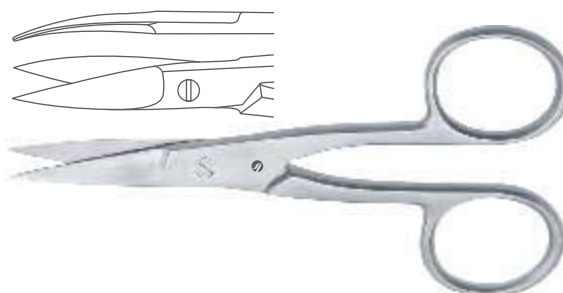

Catalog #	Size
SS-579-09	9.5 cm (3 3/4")
SS-579-10	10.5 cm (4 1/4")



Bandage Scissors  
Verbandscheren  
Tijeras para vendajes  
Ciseaux pour pansements  
Forbici per bendaggi

**Smith (Mod. USA) Bandage Scissor**



Catalog #	Size
SS-582-18	18 cm (7")
SS-582-20	20 cm (8")
SS-583-23	23 cm (9")

**Bandage Scissor  
Straight**

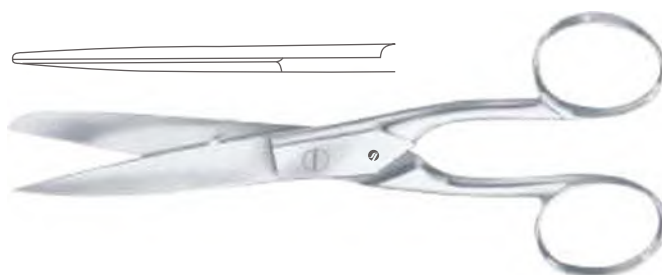

Catalog #	Size
SS-584-15	15 cm (6")

**Lorenz Bandage Scissor  
Heavy Pattern**



Catalog #	Size
SS-585-23	23 cm (9")

**Knowles Bandage Scissor  
Angled**



Catalog #	Size
SS-587-14	14 cm (5 1/2")

**Knowles Bandage Scissor (For Fingers)  
Straight**



Catalog #	Size
SS-588-14	14cm (5 1/2")



Bandage Scissors  
Verbandscheren  
Tijeras para vendajes  
Ciseaux pour pansements  
Forbici per bendaggi

**Lister Bandage Scissor**



Catalog #	Size
SS-591-14	14.5 cm (5 3/4")
SS-591-18	18.5 cm (7 1/4")
SS-591-20	20 cm (8")

**Lister Bandage Scissor**  
One Large Ring



Catalog #	Size
SS-593-18	18.5 cm (7 1/4")
SS-593-21	21 cm (8 1/4")

**Lister (Eccentric) Bandage Scissor**  
One Toothed Cutting Edge



Catalog #	Size
SS-595-16	16 cm (6 1/4")
SS-595-19	19 cm (7 1/2")

**Bergmann Bandage Scissor**  
Heavy Pattern



Catalog #	Size
SS-597-23	23.5 cm (9 1/4")



Bandage Scissors, Plaster Shears  
 Verbandscheren, Gipsscheren  
 Tijeras para vendajes, Tijeras para yeso  
 Ciseaux pour pansements, Ciseaux pour plâtre  
 Forbici per bendaggi, Forbici per gesso

**Esmarch Bandage Scissor**  
 Heavy Pattern, Short Blades

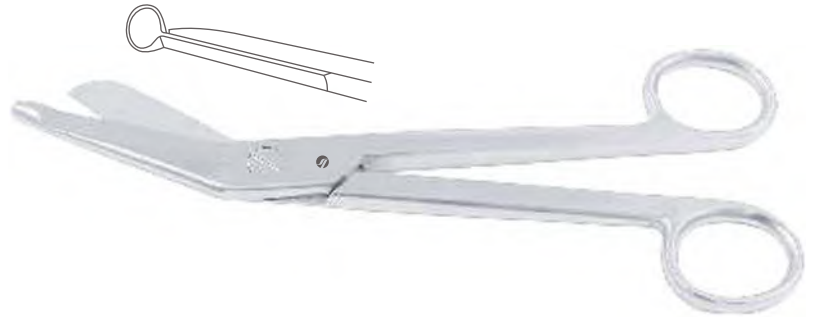

Catalog #	Size
SS-599-20	20 cm (8")
SS-599-23	23 cm (9")

**Universal Bandage Scissor**  
 Plastic Handle



Catalog #	Size	Handle Colour
SS-601-14	14.5 cm (5 3/4")	Black
SS-601-16	16 cm (6 1/4")	Black
SS-601-18	18 cm (7 1/2")	Black
SS-603-14	14.5 cm (5 3/4")	Blue
SS-603-16	16 cm (6 1/4")	Blue
SS-603-18	18 cm (7 1/2")	Blue
SS-605-14	14.5 cm (5 3/4")	Red
SS-605-16	16 cm (6 1/4")	Red
SS-605-18	18 cm (7 1/2")	Red
SS-607-14	14.5 cm (5 3/4")	Green
SS-607-16	16 cm (6 1/4")	Green
SS-607-18	18 cm (7 1/2")	Green

**Seutin Plaster of Paris Shear**



Catalog #	Size
SS-609-23	23 cm (9")



Plaster Shears  
Gipsscheren  
Tijeras para yeso  
Ciseaux pour plâtre  
Forbici per gesso

SS

SCISSORS

**Plaster of Paris Shear**  
One Toothed Cutting Edge

Catalog #	Size
SS-611-20	20 cm (8")



**Bruns Plaster of Paris Shear**  
One Toothed Cutting Edge

Catalog #	Size
SS-613-24	24 cm (9 1/2")







Micro Scissors  
Mikroscheren  
Micro-Tijeras  
Micro-Ciseaux  
Micro-Forbici

**Noyes Iris Scissor**  
Straight, Sharp/Sharp



Catalog #	Size
SS-630-12	12.5 cm (5")

**Noyes Iris Scissor**  
Curved, Sharp/Sharp



Catalog #	Size
SS-631-12	12.5 cm (5")

**Noyes Iris Scissor**  
Straight, Sharp/Blunt



Catalog #	Size
SS-632-12	12.5 cm (5")

**Noyes Iris Scissor**  
Curved, Sharp/Blunt



Catalog #	Size
SS-633-12	12.5 cm (5")

**Noyes Iris Scissor**  
Straight, Blunt/Blunt



Catalog #	Size
SS-634-12	12.5 cm (5")





Micro Scissors  
Mikroscheren  
Micro-Tijeras  
Micro-Ciseaux  
Micro-Forbici

**Noyes Iris Scissor**  
Curved, Blunt/Blunt



Catalog #	Size
SS-635-12	12.5 cm (5")

**Micro Scissor**  
Straight



Catalog #	Size
SS-636-12	12 cm (4 3/4")

**Micro Scissor**  
Curved



Catalog #	Size
SS-637-12	12 cm (4 3/4")

**Wecker Iris Scissor**  
Angled, Sharp/Sharp



Catalog #	Size
SS-641-11	11 cm (4 1/2")

**Wecker Iris Scissor**  
Angled, Sharp/Blunt



Catalog #	Size
SS-643-11	11 cm (4 1/2")



Micro Scissors  
Mikroscheren  
Micro-Tijeras  
Micro-Ciseaux  
Micro-Forbici

**Wecker Iris Scissor**  
Angled, Blunt/Blunt



Catalog #	Size
SS-645-11	11 cm (4 1/2")

**Barraquer Iris Scissor**  
Angled



Catalog #	Size, Blade Size
SS-647-05	5.5 cm (2 1/4"), 5 mm
SS-647-07	5.5 cm (2 1/4"), 7 mm
SS-647-10	5.5 cm (2 1/4"), 10 mm

**Castroviejo Corneoscleral Scissor**  
Small Blades



Catalog #	Size, Profile
SS-651-01	10.5 cm (4"), Right
SS-651-02	10.5 cm (4"), Left

**Castroviejo Corneoscleral Scissor**  
Medium Blades



Catalog #	Size
SS-653-01	11 cm (4 1/2"), Right
SS-653-02	11 cm (4 1/2"), Left



**Troutman-Castroviejo Corneoscleral Scissor**  
Small Blades, With Lock

Catalog #	Size, Profile
SS-655-01	10.5 cm (4"), Right
SS-655-02	10.5 cm (4"), Left



**Troutman-Castroviejo Corneoscleral Scissor**  
Medium Blades, With Lock

Catalog #	Size, Profile
SS-657-01	11 cm (4 1/2"), Right
SS-657-02	11 cm (4 1/2"), Left



**Troutman-Katzin Corneal Transplant Scissor**  
Strongly Curved, Small Blades With Lock

Catalog #	Size, Profile
SS-659-01	10.5 cm (4"), Right
SS-659-02	10.5 cm (4"), Left



**Katzin Corneal Transplant Scissor**  
Strongly Curved, Medium Blades With Lock

Catalog #	Size, Profile
SS-661-01	11 cm (4 1/2"), Right
SS-661-02	11 cm (4 1/2"), Left





Micro Scissors  
Mikroscheren  
Micro-Tijeras  
Micro-Ciseaux  
Micro-Forbici

**Castroviejo Universal Cornel Scissor**  
Curved, Blunt Tips, Small Blades

Catalog #	Size, Profile
SS-663-11	11 cm (4 1/2"), Small Blades
SS-665-11	11 cm (4 1/2"), Medium Blades
SS-667-11	11 cm (4 1/2"), Large Blades



**Castroviejo Universal Cornel Scissor**  
Strongly Curved, Blunt Tips

Catalog #	Size
SS-669-11	11.5 cm (4 1/2")



**Castroviejo Keratoplasty Scissor**  
Angled, Blunt Tips, Medium Blades

Catalog #	Size
SS-671-11	11.5 cm (4 1/2")



**McPherson-Westcott Conjunctival Scissor**  
Curved, Blunt Tips, Small Blades

Catalog #	Size
SS-673-11	11 cm (4 1/2")



**Westcott Tenotomy Scissor**  
Curved, Blunt Tips, Medium Blades

Catalog #	Size
SS-675-11	11 cm (4 1/2")





Micro Scissors  
Mikroscheren  
Micro-Tijeras  
Micro-Ciseaux  
Micro-Forbici

**Westcott Tenotomy Scissor**  
Curved, Blunt Tips, Standard Blades



Catalog #	Size, Profile
SS-677-01	11.5 cm (4 1/2"), Right
SS-677-02	11.5 cm (4 1/2"), Left

**Tibolt Punctal Scissor**  
One Conically Shaped Blade with Micro Grooves & Textured Surface



Catalog #	Size
SS-679-11	11.5 cm (4 1/2")

**McPherson-Westcott Stitch Scissor**  
Curved, Very Sharp Pointed Tips, Small Blades



Catalog #	Size
SS-681-11	11 cm (4 1/2")

**Westcott Stitch Scissor**  
Curved, Very Sharp Pointed Tips, Standard Blades



Catalog #	Size
SS-683-11	11.5 cm (4 1/2")

**Jaffe Stitch Scissor**  
Curved, Very Sharp Pointed Tips, Medium Blades



Catalog #	Size
SS-685-11	11 cm (4 1/2")



Micro Scissors  
Mikroscheren  
Micro-Tijeras  
Micro-Ciseaux  
Micro-Forbici

**Iris Micro Scissor**  
Straight, Sharp Tips, Small Blades

Catalog #	Size
SS-688-11	11 cm (4 1/2")



**Iris Micro Scissor**  
Curved, Sharp Tips, Small Blades

Catalog #	Size
SS-689-11	11 cm (4 1/2")



**Fine Micro Scissor**  
Straight, Sharp Tips, Medium Blades

Catalog #	Size
SS-690-11	11.5 cm (4 1/2")



**Fine Stitch Scissor**  
Curved, Sharp Tips, Medium Blades

Catalog #	Size
SS-691-11	11.5 cm (4 1/2")



**Vannas Capsulotomy Scissor**  
Straight, Sharp Tips

Catalog #	Size, Blade Size
SS-694-08	8 cm (3 1/4"), 5 mm





Micro Scissors  
Mikroscheren  
Micro-Tijeras  
Micro-Ciseaux  
Micro-Forbici

SS

SCISSORS

**Vannas Capsulotomy Scissor**

Curved, Sharp Tips



Catalog #	Size, Blade Size
SS-695-08	8 cm (3 1/4"), 5 mm

**Vannas Capsulotomy Scissor**

Angled Forward, Sharp Tips



Catalog #	Size, Blade Size
SS-696-08	8 cm (3 1/4"), 5 mm

**Vannas Capsulotomy Scissor**

Angled to Side, Sharp Tips



Catalog #	Size, Blade Size
SS-697-08	8 cm (3 1/4"), 5 mm

**Gills-Vannas Capsulotomy Scissor**

Straight, Sharp Tips



Catalog #	Size, Blade Size
SS-698-08	8 cm (3 1/4"), 7 mm

**Gills-Vannas Capsulotomy Scissor**

Curved, Sharp Tips



Catalog #	Size, Blade Size
SS-699-08	8 cm (3 1/4"), 7 mm





Micro Scissors  
Mikroscheren  
Micro-Tijeras  
Micro-Ciseaux  
Micro-Forbici

**Gills-Vannas Capsulotomy Scissor**  
Angled Forward, Sharp Tips



Catalog #	Size, Blade Size
SS-701-08	8 cm (3 1/4"), 7 mm

**McPherson-Vannas Iris Scissor**  
Curved, Sharp Tips



Catalog #	Size
SS-703-08	8 cm (3 1/4")

**Gills-Vannas Micro Scissor**  
Straight, Sharp Tips, Extra Thin



Catalog #	Size, Blade Size
SS-706-10	10.5 cm (4"), 7 mm

**Gills-Vannas Micro Scissor**  
Curved, Sharp Tips, Extra Thin



Catalog #	Size, Blade Size
SS-707-10	10.5 cm (4"), 7 mm

**Gills-Vannas Micro Scissor**  
Angled Forward, Sharp Tips, Extra Thin



Catalog #	Size, Blade Size
SS-709-10	10.5 cm (4"), 7 mm





Micro Scissors  
Mikroscheren  
Micro-Tijeras  
Micro-Ciseaux  
Micro-Forbici

**Stern-Gills Micro Scissor**  
Straight, Sharp Tips, Extra Thin



Catalog #	Size, Blade Size
SS-710-11	11 cm (4 1/2"), 10 mm

**Stern-Gills Micro Scissor**  
Curved, Sharp Tips, Extra Thin



Catalog #	Size, Blade Size
SS-711-11	11 cm (4 1/2"), 10 mm

**Stern-Gills Micro Scissor**  
Angled Forward, Sharp Tips, Extra Thin



Catalog #	Size, Blade Size
SS-713-11	11 cm (4 1/2"), 10 mm

**Gills Capsulotomy Scissor**  
Angled Blades With Curved Tips, Sharp Points



Catalog #	Size, Blade Size
SS-715-11	10.5 cm (4"), 10 mm

**Vannas Micro Scissor**  
Straight

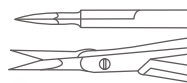

Catalog #	Size
SS-726-12	12 cm (4 3/4")



Micro Scissors  
Mikroscheren  
Micro-Tijeras  
Micro-Ciseaux  
Micro-Forbici

**Vannas Micro Scissor**  
Curved

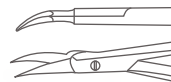

Catalog #	Size
SS-727-12	12 cm (4 3/4")

**Vannas Micro Scissor**  
Angled on Flat

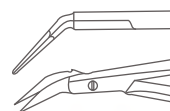

Catalog #	Size
SS-729-12	12 cm (4 3/4")

**Biemer Vein Scissor**

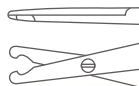

Catalog #	Size
SS-730-13	13 cm (5")

**Micro Scissor**  
Straight

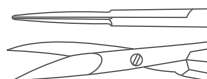

Catalog #	Size
SS-732-16	16 cm (6 1/4")

**Micro Scissor**  
Curved

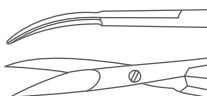

Catalog #	Size
SS-733-16	16 cm (6 1/4")

INCHES  
MILLIMETERS



Micro Scissors  
Mikroscheren  
Micro-Tijeras  
Micro-Ciseaux  
Micro-Forbici

**Jacobson Micro Scissor**  
Curved

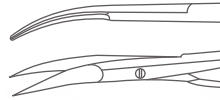

Catalog #	Size
SS-739-18	18.5 cm (7 1/4")

**Adventitia Micro Scissor**  
Straight, Sharp/Sharp

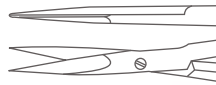

Catalog #	Size
SS-740-14	14.5 cm (5 3/4")

**Micro Scissor**  
Curved, Sharp/Sharp

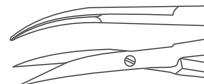

Catalog #	Size
SS-741-14	14.5 cm (5 3/4")

**Micro Dissecting Scissor**  
Curved, Blunt/Blunt



Catalog #	Size
SS-743-14	14.5 cm (5 3/4")

**Micro Scissor**  
Straight, Delicate Blades

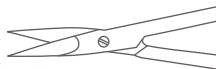

Catalog #	Size
SS-744-16	16.5 cm (6 1/2")



Micro Scissors  
Mikroscheren  
Micro-Tijeras  
Micro-Ciseaux  
Micro-Forbici

**Micro Scissor**  
Curved, Delicate Blades



Catalog #	Size
SS-745-16	16.5 cm (6 1/2")

**Micro Scissor**  
Straight, Extra Delicate Blades



Catalog #	Size
SS-746-16	16.5 cm (6 1/2")

**Micro Scissor**  
Curved, Extra Delicate Blades



Catalog #	Size
SS-747-16	16.5 cm (6 1/2")

**Vannas Micro Scissor**  
Straight



Catalog #	Size
SS-734-16	16 cm (6 1/4")

**Vannas Micro Scissor**  
Curved



Catalog #	Size
SS-735-16	16 cm (6 1/4")



Micro Scissors  
Mikroscheren  
Micro-Tijeras  
Micro-Ciseaux  
Micro-Forbici

**Millesi Micro Scissor**  
Straight

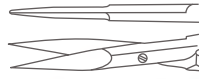

Catalog #	Size
SS-736-16	16 cm (6 1/4")

**Millesi Micro Scissor**  
Curved

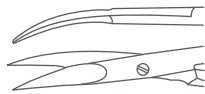

Catalog #	Size
SS-737-16	16 cm (6 1/4")

**Yasargil Micro Scissor**  
Straight

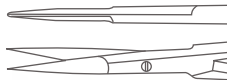

Catalog #	Size
SS-738-18	18.5 cm (7 1/4")



Micro Scissors  
Mikroscheren  
Micro-Tijeras  
Micro-Ciseaux  
Micro-Forbici

**Micro Coronary Scissor**



SS-751-25, Angled 25°



SS-751-45, Angled 45°



SS-751-60, Angled 60°



SS-751-90, Angled 90°



SS-753-00, Angled 125°

Catalog #	Size, Profile
SS-751-25	18 cm (7"), Angled 25°
SS-751-45	18 cm (7"), Angled 45°
SS-751-60	18 cm (7"), Angled 60°
SS-751-90	18 cm (7"), Angled 90°
SS-753-00	18 cm (7"), Angled 125°

**Micro Coronary Scissor  
Titanium**



SS-751-25 T, Angled 25°



SS-751-45 T, Angled 45°



SS-751-60 T, Angled 60°



SS-751-90 T, Angled 90°



SS-753-00 T, Angled 125°

Catalog #	Size, Profile
SS-751-25 T	18 cm (7"), Angled 25°
SS-751-45 T	18 cm (7"), Angled 45°
SS-751-60 T	18 cm (7"), Angled 60°
SS-751-90 T	18 cm (7"), Angled 90°
SS-753-00 T	18 cm (7"), Angled 125°



Micro Scissors  
Mikroscheren  
Micro-Tijeras  
Micro-Ciseaux  
Micro-Forbici

SS

SCISSORS

**Micro Coronary Scissor**  
Fine Blade

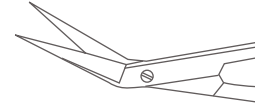

SS-755-25, Angled 25°

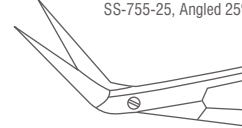

SS-755-45, Angled 45°



SS-755-60, Angled 60°



SS-755-90, Angled 90°



SS-757-00, Angled 125°

Catalog #	Size, Profile
SS-755-25	16.5 cm (6 1/2"), Angled 25°
SS-755-45	16.5 cm (6 1/2"), Angled 45°
SS-755-60	16.5 cm (6 1/2"), Angled 60°
SS-755-90	16.5 cm (6 1/2"), Angled 90°
SS-757-00	16.5 cm (6 1/2"), Angled 125°

**Micro Coronary Scissor**  
Fine Blades, One Blade with Probe Tip

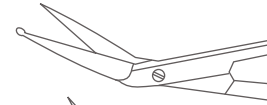

SS-759-25, Angled 25°

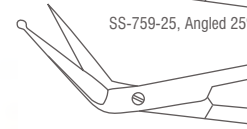

SS-759-45, Angled 45°

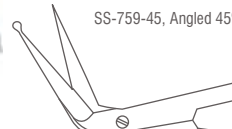

SS-759-60, Angled 60°



SS-759-90, Angled 90°



SS-761-00, Angled 125°

Catalog #	Size, Profile
SS-759-25	16.5 cm (6 1/2"), Angled 25°
SS-759-45	16.5 cm (6 1/2"), Angled 45°
SS-759-60	16.5 cm (6 1/2"), Angled 60°
SS-759-90	16.5 cm (6 1/2"), Angled 90°
SS-761-00	16.5 cm (6 1/2"), Angled 125°





Micro Scissors  
Mikroscheren  
Micro-Tijeras  
Micro-Ciseaux  
Micro-Forbici

**Micro Coronary Scissor**  
Delicate Blades

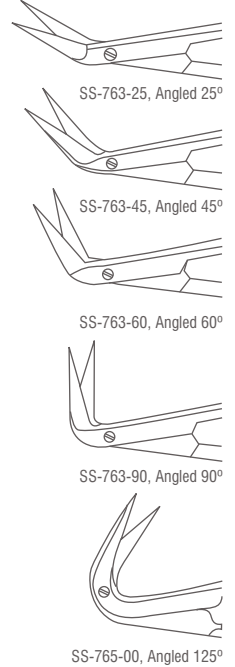

Catalog #	Size, Profile
SS-763-25	16.5 cm (6 1/2"), Angled 25°
SS-763-45	16.5 cm (6 1/2"), Angled 45°
SS-763-60	16.5 cm (6 1/2"), Angled 60°
SS-763-90	16.5 cm (6 1/2"), Angled 90°
SS-765-00	16.5 cm (6 1/2"), Angled 125°

**Micro Coronary Scissor**  
Extra Delicate Blades

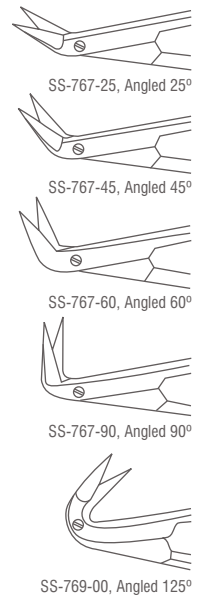

Catalog #	Size, Profile
SS-767-25	16.5 cm (6 1/2"), Angled 25°
SS-767-45	16.5 cm (6 1/2"), Angled 45°
SS-767-60	16.5 cm (6 1/2"), Angled 60°
SS-767-90	16.5 cm (6 1/2"), Angled 90°
SS-769-00	16.5 cm (6 1/2"), Angled 125°





Micro Scissors  
Mikroscheren  
Micro-Tijeras  
Micro-Ciseaux  
Micro-Forbici

**Micro Scissor**  
Straight, Delicate Blades, Round Handle



Catalog #	Size
SS-770-16	16.5 cm (6 1/2")

**Micro Scissor**  
Curved, Delicate Blades, Round Handle



Catalog #	Size
SS-771-16	16.5 cm (6 1/2")

**Micro Scissor**  
Curved, Extra Delicate Blades, Round Handle



Catalog #	Size
SS-773-16	16.5 cm (6 1/2")



Micro Scissors  
Mikroscheren  
Micro-Tijeras  
Micro-Ciseaux  
Micro-Forbici

**Micro Coronary Scissor**  
Fine Blades, Round Handle



Catalog #	Size, Profile
SS-755-25	16.5 cm (6 1/2"), Angled 25°
SS-755-45	16.5 cm (6 1/2"), Angled 45°
SS-755-60	16.5 cm (6 1/2"), Angled 60°
SS-755-90	16.5 cm (6 1/2"), Angled 90°
SS-777-00	16.5 cm (6 1/2"), Angled 125°

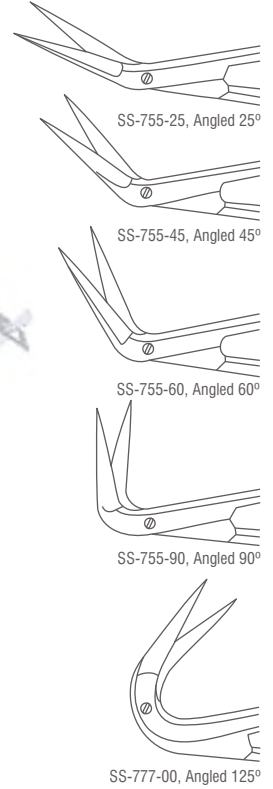

**Micro Coronary Scissor**  
Fine Blades, One Blade with Probe Tip, Round Handle



Catalog #	Size, Profile
SS-779-25	16.5 cm (6 1/2"), Angled 25°
SS-779-45	16.5 cm (6 1/2"), Angled 45°
SS-779-60	16.5 cm (6 1/2"), Angled 60°
SS-779-90	16.5 cm (6 1/2"), Angled 90°
SS-781-00	16.5 cm (6 1/2"), Angled 125°

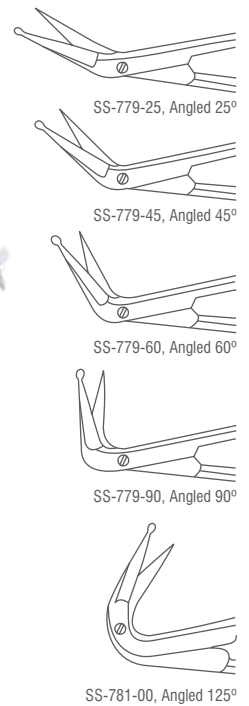



Micro Scissors  
Mikroscheren  
Micro-Tijeras  
Micro-Ciseaux  
Micro-Forbici

SS

SCISSORS

**Micro Coronary Scissor**  
Delicate Blades, Round Handle



Catalog #	Size, Profile
SS-783-25	16.5 cm (6 1/2"), Angled 25°
SS-783-45	16.5 cm (6 1/2"), Angled 45°
SS-783-60	16.5 cm (6 1/2"), Angled 60°
SS-783-90	16.5 cm (6 1/2"), Angled 90°
SS-785-00	16.5 cm (6 1/2"), Angled 125°

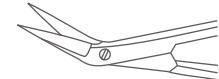

SS-783-25, Angled 25°



SS-783-45, Angled 45°



SS-783-60, Angled 60°

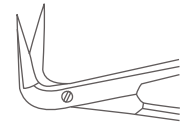

SS-783-90, Angled 90°



SS-785-00, Angled 125°

**Micro Coronary Scissor**  
Extra Delicate Blades, Round Handle



Catalog #	Size, Profile
SS-787-25	16.5 cm (6 1/2"), Angled 25°
SS-787-45	16.5 cm (6 1/2"), Angled 45°
SS-787-60	16.5 cm (6 1/2"), Angled 60°
SS-787-90	16.5 cm (6 1/2"), Angled 90°
SS-789-00	16.5 cm (6 1/2"), Angled 125°

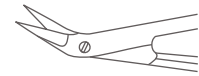

SS-787-25, Angled 25°



SS-787-45, Angled 45°

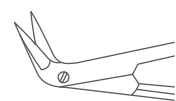

SS-787-60, Angled 60°

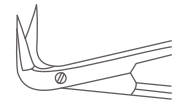

SS-787-90, Angled 90°



SS-789-00, Angled 125°



Micro Scissors  
Mikroscheren  
Micro-Tijeras  
Micro-Ciseaux  
Micro-Forbici

**Micro Scissor**  
Straight, Round Handle



Catalog #	Size
SS-790-18	18 cm (7")

**Micro Scissor**  
Curved, Round Handle



Catalog #	Size
SS-791-18	18 cm (7")

**Micro Scissor**  
Curved, One Blade with Probe Tip, Round Handle



Catalog #	Size
SS-793-18	18 cm (7")

**Micro Suture Cutting Scissor**  
Straight, One Toothed Cutting Edge, Round Handle



Catalog #	Size
SS-796-18	18 cm (7")

**Micro Scissor**  
Straight, Round Handle



Catalog #	Size, Blade Size
SS-800-15	15 cm (6"), 10 mm
SS-800-18	18 cm (7"), 10 mm
SS-800-21	21 cm (8 1/4"), 10 mm
SS-800-23	23 cm (9"), 10 mm



Micro Scissors  
Mikroscheren  
Micro-Tijeras  
Micro-Ciseaux  
Micro-Forbici

**Micro Scissor**

Straight, Round Handle, Titanium

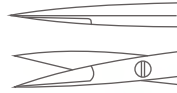

Catalog #	Size, Blade Size
SS-800-15 T	15 cm (6"), 10 mm
SS-800-18 T	18 cm (7"), 10 mm
SS-800-21 T	21 cm (8 1/4"), 10 mm

**Micro Scissor**

Curved, Round Handle

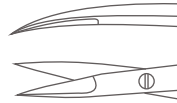

Catalog #	Size, Blade Size
SS-801-15	15 cm (6"), 10 mm
SS-801-18	18 cm (7"), 10 mm
SS-801-21	21 cm (8 1/4"), 10 mm
SS-801-23	23 cm (9"), 10 mm

**Micro Scissor**

Curved, Round Handle, Titanium

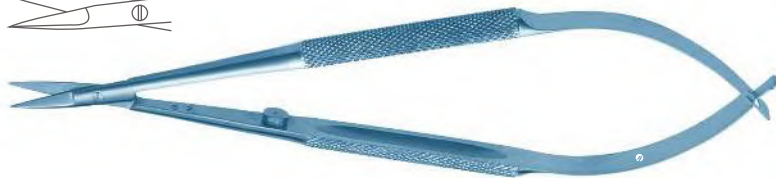
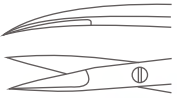

Catalog #	Size, Blade Size
SS-801-15 T	15 cm (6"), 10 mm
SS-801-18 T	18 cm (7"), 10 mm
SS-801-21 T	21 cm (8 1/4"), 10 mm

**Micro Scissor**

Straight, Flat Handle

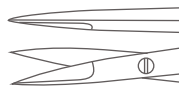

Catalog #	Size, Blade Size
SS-804-15	15 cm (6"), 10 mm
SS-804-18	18 cm (7"), 10 mm
SS-804-21	21 cm (8 1/4"), 10 mm
SS-804-23	23 cm (9"), 10 mm



Micro Scissors  
Mikroscheren  
Micro-Tijeras  
Micro-Ciseaux  
Micro-Forbici

**Micro Scissor**  
Straight, Flat Handle, Titanium

Catalog #	Size, Blade Size
SS-804-15 T	15 cm (6"), 10 mm
SS-804-18 T	18 cm (7"), 10 mm
SS-804-21 T	21 cm (8 1/4"), 10 mm

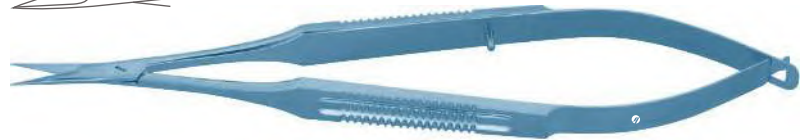

**Micro Scissor**  
Curved, Flat Handle

Catalog #	Size, Blade Size
SS-805-15	15 cm (6"), 10 mm
SS-805-18	18 cm (7"), 10 mm
SS-805-21	21 cm (8 1/4"), 10 mm
SS-805-23	23 cm (9"), 10 mm

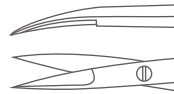

**Micro Scissor**  
Curved, Flat Handle, Titanium

Catalog #	Size, Blade Size
SS-805-15 T	15 cm (6"), 10 mm
SS-805-18 T	18 cm (7"), 10 mm
SS-805-21 T	21 cm (8 1/4"), 10 mm

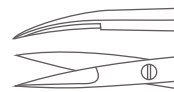

**Jacobson Micro Scissor**  
Straight, Bayonet Shaped

Catalog #	Size
SS-808-23	23 cm (9")

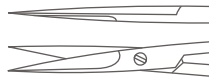



Micro Scissors  
Mikroscheren  
Micro-Tijeras  
Micro-Ciseaux  
Micro-Forbici

**Potts Micro Scissor**  
Curved, Bayonet Shaped

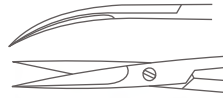

Catalog #	Size
SS-809-23	23 cm (9")

**Micro Scissor**  
Straight, Bayonet Shaped

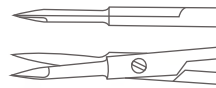

Catalog #	Size
SS-810-23	23 cm (9")

**Micro Scissor**  
Curved, Bayonet Shaped

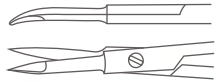

Catalog #	Size
SS-811-23	23 cm (9")

**Micro Scissor**  
Straight, Bayonet Shaped

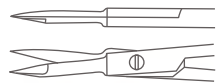

Catalog #	Size
SS-814-19	18.5 cm (7 1/4")

**Micro Scissor**  
Curved, Bayonet Shaped

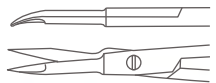

Catalog #	Size
SS-815-19	18.5 cm (7 1/4")





Micro Scissors  
Mikroscheren  
Micro-Tijeras  
Micro-Ciseaux  
Micro-Forbici

**Micro Scissor**  
Straight, Bayonet Shaped

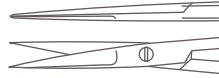

Catalog #	Size
SS-816-19	19 cm (7 1/2")
SS-816-21	21.5 cm (8 1/2")

**Micro Scissor**  
Curved Downwards, Bayonet Shaped

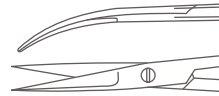

Catalog #	Size
SS-817-19	18.5 cm (7 1/4")
SS-817-21	21.5 cm (8 1/2")

**Micro Scissor**  
Curved Upwards, Bayonet Shaped

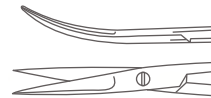

Catalog #	Size
SS-819-19	18.5 cm (7 1/4")
SS-819-21	21.5 cm (8 1/2")

**Jaboma Micro Scissor**  
Angled, One Blade Probe Tip

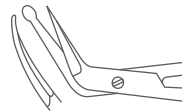

Catalog #	Size, Blade Size
SS-825-18	18 cm (7"), 12 mm

**Jaboma Micro Scissor**  
Angled, One Blade Probe Tip

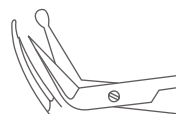

Catalog #	Size, Blade Size
SS-827-18	18 cm (7"), 12 mm



Micro Scissors  
Mikroscheren  
Micro-Tijeras  
Micro-Ciseaux  
Micro-Forbici

**Jaboma Micro Scissor (For Cleft Palate)**  
Angled

Catalog #	Size, Blade Size
SS-829-18	18 cm (7"), 12 mm





Operating Scissors  
Chirurgische Scheren  
Tijeras quirúrgicas  
Ciseaux chirurgicaux  
Forbici per chirurgia

**UltraCut™ TC Operating Scissor**  
Straight, Blunt/Blunt

**ULTRA.Cut™**

Catalog #	Size
SS-850-14	14.5 cm (5 ¾")

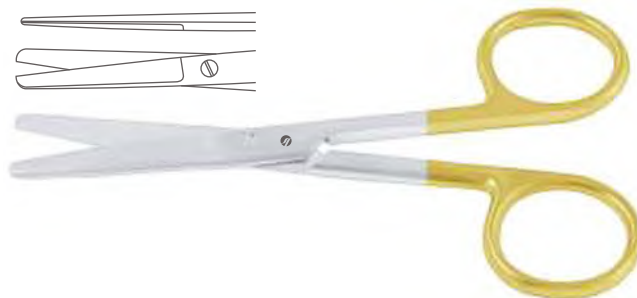

**UltraCut™ TC Operating Scissor**  
Curved, Blunt/Blunt

**ULTRA.Cut™**

Catalog #	Size
SS-851-14	14.5 cm (5 ¾")

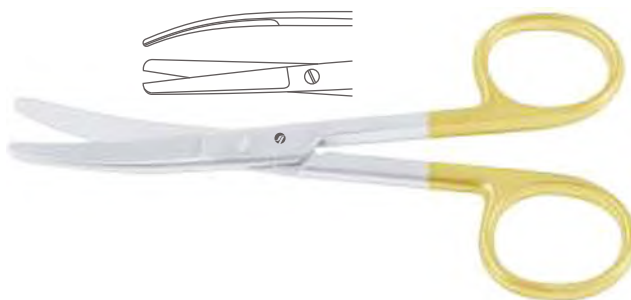
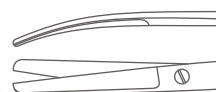

**UltraCut™ TC Operating Scissor**  
Straight, Sharp/Blunt

**ULTRA.Cut™**

Catalog #	Size
SS-852-14	14.5 cm (5 ¾")

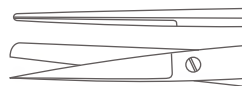

**XTSCut™ TC Operating Scissor**  
Straight, Sharp/Blunt

**XTS Cut™**

Catalog #	Size
SS-852-14 SC	14.5 cm (5 ¾")

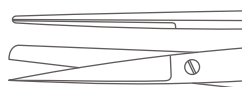

**UltraCut™ TC Operating Scissor**  
Curved, Sharp/Blunt

**ULTRA.Cut™**

Catalog #	Size
SS-853-14	14.5 cm (5 ¾")

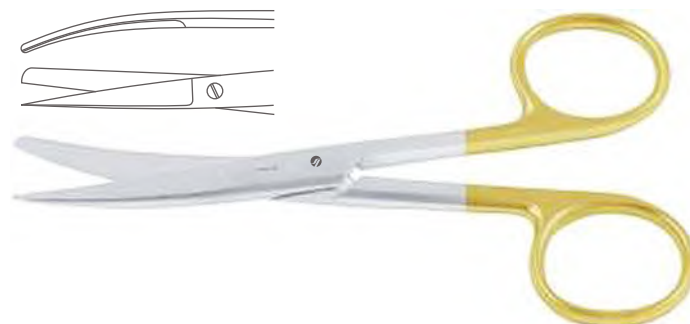
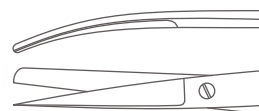



Operating Scissors  
Chirurgische Scheren  
Tijeras quirúrgicas  
Ciseaux chirurgicaux  
Forbici per chirurgia

**XTSCut™ TC Operating Scissor**  
Curved, Sharp/Blunt



Catalog #	Size
SS-853-14 SC	14.5 cm (5 ¾")

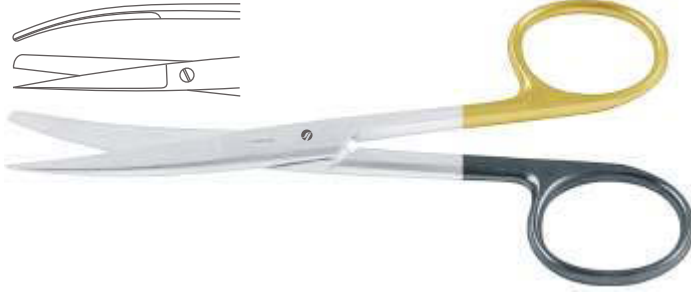

**UltraCut™ TC Operating Scissor**  
Straight, Sharp/Sharp



Catalog #	Size
SS-854-14	14.5 cm (5 ¾")



**UltraCut™ TC Operating Scissor**  
Curved, Sharp/Sharp



Catalog #	Size
SS-855-14	14.5 cm (5 ¾")



**UltraCut™ TC Mayo Dissecting Scissor**  
Straight



Catalog #	Size
SS-860-14	14.5 cm (5 ¾")
SS-860-17	17 cm (6 ¾")
SS-860-23	23 cm (9")



**XTSCut™ TC Mayo Dissecting Scissor**  
Straight



Catalog #	Size
SS-860-14 SC	14.5 cm (5 ¾")
SS-860-17 SC	17 cm (6 ¾")
SS-860-23 SC	23 cm (9")





Operating Scissors  
Chirurgische Scheren  
Tijeras quirúrgicas  
Ciseaux chirurgicaux  
Forbici per chirurgia

**UltraCut™ TC Mayo Dissecting Scissor**  
Curved

**ULTRA** *Cut*™

Catalog #	Size
SS-861-14	14.5 cm (5 ¾")
SS-861-17	17 cm (6 ¾")
SS-861-23	23 cm (9")



**XTSCut™ TC Mayo Dissecting Scissor**  
Curved

**XTS** *Cut*™

Catalog #	Size
SS-861-14 SC	14.5 cm (5 ¾")
SS-861-17 SC	17 cm (6 ¾")
SS-861-23 SC	23 cm (9")



**UltraCut™ TC Mayo-Stille Dissecting Scissor**  
Straight

**ULTRA** *Cut*™

Catalog #	Size
SS-890-15	15 cm (6")
SS-890-17	17 cm (6 ¾")



**XTSCut™ TC Mayo-Stille Dissecting Scissor**  
Straight

**XTS** *Cut*™

Catalog #	Size
SS-890-15 SC	15 cm (6")
SS-890-17 SC	17 cm (6 ¾")





Operating Scissors  
Chirurgische Scheren  
Tijeras quirúrgicas  
Ciseaux chirurgicaux  
Forbici per chirurgia

**UltraCut™ TC Mayo-Stille Dissecting Scissor**  
Curved

**ULTRACut™**

Catalog #	Size
SS-891-15	15 cm (6")
SS-891-17	17 cm (6 ¾")



**XTSCut™ TC Mayo-Stille Dissecting Scissor**  
Curved

**XTSCut™**

Catalog #	Size
SS-891-15 SC	15 cm (6")
SS-891-17 SC	17 cm (6 ¾")

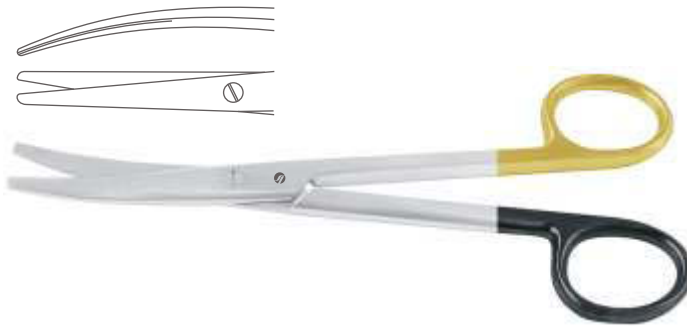

**UltraCut™ TC Metzenbaum Dissecting Scissor**  
Straight

**ULTRACut™**

Catalog #	Size
SS-900-11	11.5 cm (4 ½")



**UltraCut™ TC Metzenbaum Dissecting Scissor**  
Curved

**ULTRACut™**

Catalog #	Size
SS-901-11	11.5 cm (4 ½")



**UltraCut™ TC Metzenbaum Dissecting Scissor**  
Straight

**ULTRACut™**

Catalog #	Size
SS-902-14	14.5 cm (5 ¾")





Operating Scissors  
Chirurgische Scheren  
Tijeras quirúrgicas  
Ciseaux chirurgicaux  
Forbici per chirurgia

**XTSCut™ TC Metzenbaum Dissecting Scissor**  
Straight



Catalog #	Size
SS-902-14 SC	14.5 cm (5 ¾")



**UltraCut™ TC Metzenbaum Dissecting Scissor**  
Curved



Catalog #	Size
SS-903-14	14.5 cm (5 ¾")



**XTSCut™ TC Metzenbaum Dissecting Scissor**  
Curved



Catalog #	Size
SS-903-14 SC	14.5 cm (5 ¾")

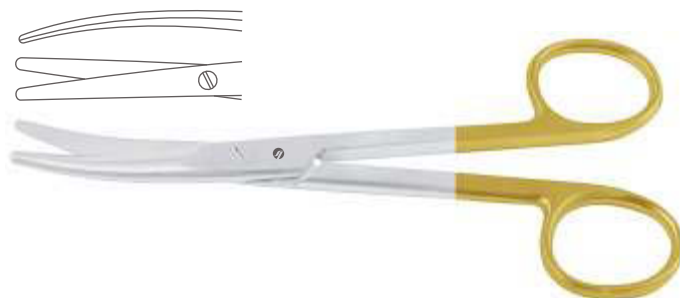

**UltraCut™ TC Metzenbaum Dissecting Scissor**  
Straight



Catalog #	Size
SS-904-18	18 cm (7")
SS-904-20	20.5 cm (8")
SS-904-23	23 cm (9")
SS-904-25	26 cm (10 ¼")
SS-904-28	28.5 cm (11 ¼")
SS-904-30	31 cm (12 ¼")







Operating Scissors  
Chirurgische Scheren  
Tijeras quirúrgicas  
Ciseaux chirurgicaux  
Forbici per chirurgia

**XTSCut™ TC Metzenbaum Dissecting Scissor**  
Straight



Catalog #	Size
SS-904-18 SC	18 cm (7")
SS-904-20 SC	20.5 cm (8")
SS-904-23 SC	23 cm (9")



**UltraCut™ TC Metzenbaum Dissecting Scissor**  
Curved



Catalog #	Size
SS-905-18	18 cm (7")
SS-905-20	20.5 cm (8")
SS-905-23	23 cm (9")
SS-905-25	26 cm (10 1/4")
SS-905-28	28.5 cm (11 1/4")
SS-905-30	31 cm (12 1/4")

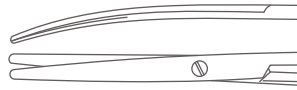

**XTSCut™ TC Metzenbaum Dissecting Scissor**  
Curved



Catalog #	Size
SS-905-18 SC	18 cm (7")
SS-905-20 SC	20.5 cm (8")
SS-905-23 SC	23 cm (9")

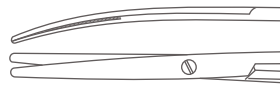

**UltraCut™ TC Metzenbaum -Thorek Dissecting Scissor**  
Curved



Catalog #	Size
SS-907-20	20 cm (8")
SS-907-23	23 cm (9")
SS-907-28	28 cm (11")





Operating Scissors, Dissecting Scissors  
Chirurgische Scheren, Präparierscheren  
Tijeras quirúrgicas, Tijeras de disección  
Ciseaux chirurgicaux, Ciseaux à dissection  
Forbici per chirurgia, Forbici per dissezione

**UltraCut™ TC Joseph Dissecting Scissor**  
Straight

**ULTRACut™**

Catalog #	Size
SS-910-14	14.5 cm (5 3/4")

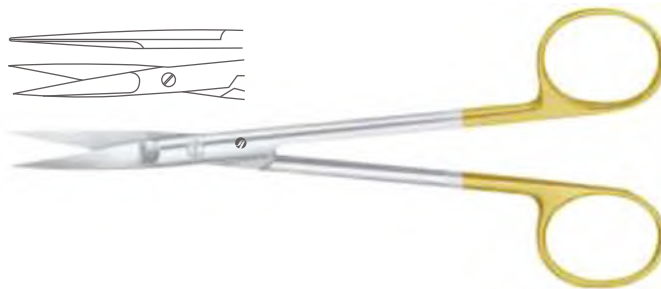

**UltraCut™ TC Joseph Dissecting Scissor**  
Curved

**ULTRACut™**

Catalog #	Size
SS-911-14	14.5 cm (5 3/4")

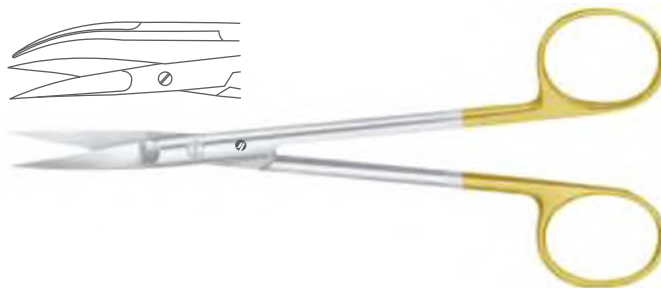

**UltraCut™ TC Lexer Dissecting Scissor**  
Straight

**ULTRACut™**

Catalog #	Size
SS-914-16	16 cm (6 1/4")
SS-914-21	21 cm (8 1/4")



**XTSCut™ TC Lexer Dissecting Scissor**  
Straight

**XTSCut™**

Catalog #	Size
SS-914-16 SC	16 cm (6 1/4")



**UltraCut™ TC Lexer Dissecting Scissor**  
Curved

**ULTRACut™**

Catalog #	Size
SS-915-16	16 cm (6 1/4")
SS-915-21	21 cm (8 1/4")





Operating Scissors, Dissecting Scissors  
Chirurgische Scheren, Präparierscheren  
Tijeras quirúrgicas, Tijeras de disección  
Ciseaux chirurgicaux, Ciseaux à dissection  
Forbici per chirurgia, Forbici per dissezione

**XTSCut™ TC Lexer Dissecting Scissor**  
Curved



Catalog #	Size
SS-915-16 SC	16 cm (6 1/4")



**UltraCut™ TC Mayo-Lexer Dissecting Scissor**  
Curved



Catalog #	Size
SS-917-16	16 cm (6 1/4")



**UltraCut™ TC Metzenbaum-Fine Delicate Dissecting Scissor**  
Straight, Slender Pattern



Catalog #	Size
SS-920-14	14.5 cm (5 3/4")



**XTSCut™ TC Metzenbaum-Fine Delicate Dissecting Scissor**  
Straight, Slender Pattern



Catalog #	Size
SS-920-14 SC	14.5 cm (5 3/4")

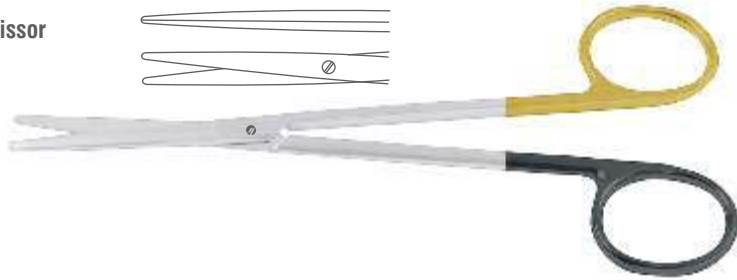

**UltraCut™ TC Metzenbaum-Fine Delicate Dissecting Scissor**  
Curved, Slender Pattern



Catalog #	Size
SS-921-14	14.5 cm (5 3/4")

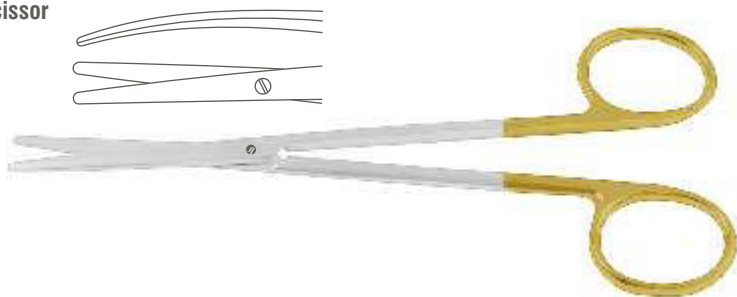



Delicate Dissecting Scissors  
Feine Präparierscheren  
Tijeras finas de disección  
Ciseaux fins à dissection  
Forbici fini per dissezione

**XTSCut™ TC Metzenbaum-Fine Delicate Dissecting Scissor**  
Curved, Slender Pattern



Catalog #	Size
SS-921-14 SC	14.5 cm (5 ¾")



**UltraCut™ TC Metzenbaum-Fine Delicate Dissecting Scissor**  
Straight, Slender Pattern



Catalog #	Size
SS-922-18	18 cm (7")
SS-922-20	20.5 cm (8")
SS-922-23	23 cm (9")
SS-922-25	25 cm (9 ¾")
SS-922-28	28 cm (11")

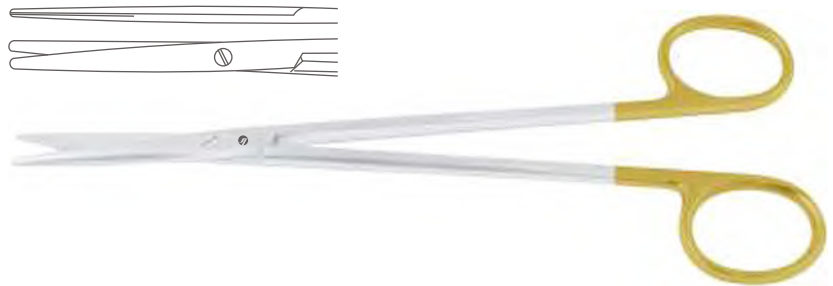

**XTSCut™ TC Metzenbaum-Fine Delicate Dissecting Scissor**  
Straight, Slender Pattern



Catalog #	Size
SS-922-18 SC	18 cm (7")
SS-922-20 SC	20.5 cm (8")
SS-922-23 SC	23 cm (9")

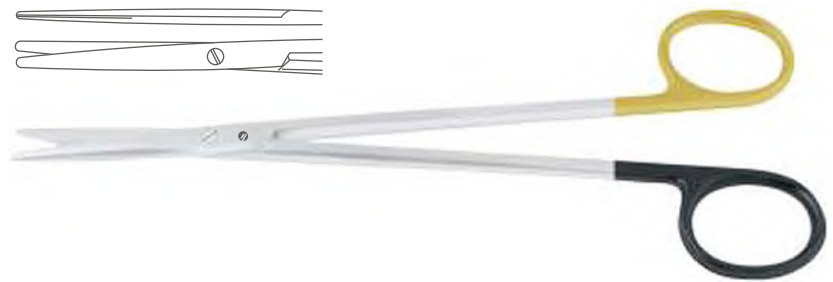

**UltraCut™ TC Metzenbaum-Fine Delicate Dissecting Scissor**  
Curved, Slender Pattern



Catalog #	Size
SS-923-18	18 cm (7")
SS-923-20	20.5 cm (8")
SS-923-23	23 cm (9")
SS-923-25	25 cm (9 ¾")
SS-923-28	28.5 cm (11 ¼")

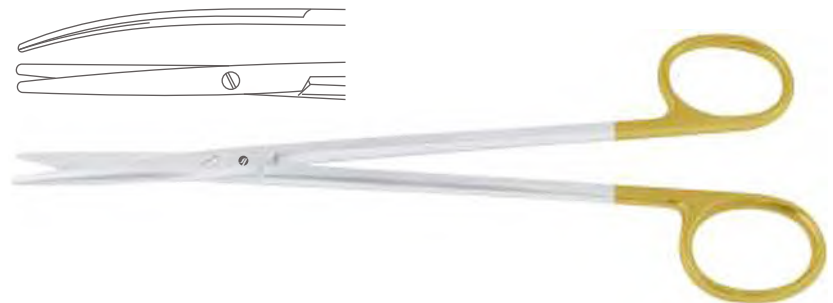



Delicate Dissecting Scissors  
Feine Präparierscheren  
Tijeras finas de disección  
Ciseaux fins à dissection  
Forbici fini per dissezione

**XTSCut™ TC Metzenbaum-Fine Delicate Dissecting Scissor**  
Curved, Slender Pattern

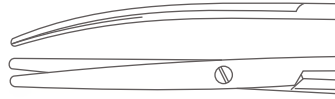

Catalog #	Size
SS-923-18 SC	18 cm (7")
SS-923-20 SC	20.5 cm (8")
SS-923-23 SC	23 cm (9")

**UltraCut™ TC Metzenbaum-Fine Delicate Dissecting Scissor**  
Straight, Sharp



Catalog #	Size
SS-926-14	14.5 cm (5 3/4")

**UltraCut™ TC Metzenbaum-Fine Delicate Dissecting Scissor**  
Curved, Sharp



Catalog #	Size
SS-927-14	14.5 cm (5 3/4")

**UltraCut™ TC Metzenbaum-Fine Delicate Dissecting Scissor**  
Straight, Sharp

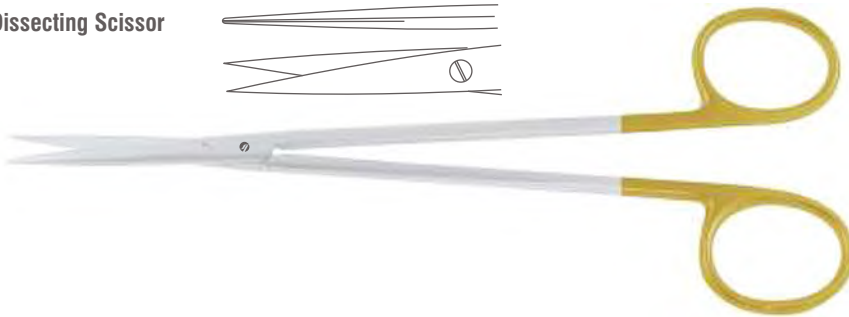

Catalog #	Size
SS-928-18	18 cm (7")
SS-928-20	20 cm (8")

**UltraCut™ TC Metzenbaum-Lahey Dissecting Scissor**  
Curved, Slender Pattern



Catalog #	Size
SS-931-14	14.5 cm (5 3/4")





Delicate Dissecting Scissors, Nasal Scissors  
 Feine Präparierscheren, Nasenscheren  
 Tijeras finas de disección, Tijeras nasales  
 Ciseaux fins à dissection, Ciseaux nasaux  
 Forbici fini per dissezione, Forbici nasali

**UltraCut™ TC Toennis-Adson Dissecting Scissor**  
 Curved, Slender Pattern

**ULTRA.Cut™**

Catalog #	Size
SS-933-17	17.5 cm (7")



**UltraCut™ TC Metzenbaum-Lahey Dissecting Scissor**  
 Curved, Slender Pattern

**ULTRA.Cut™**

Catalog #	Size
SS-935-20	20.5 cm (8")
SS-935-23	23 cm (9")

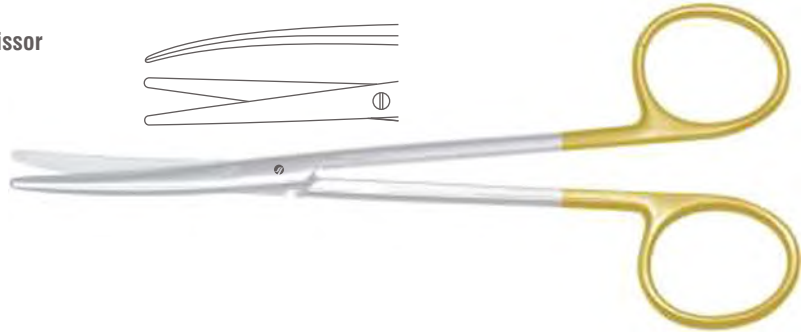
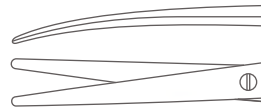

**UltraCut™ TC Metzenbaum-Fine Delicate Dissecting Scissor**  
 Curved, S Shaped, Slender Pattern

**ULTRA.Cut™**

Catalog #	Size
SS-937-18	18 cm (7")
SS-937-20	20.5 cm (8")
SS-937-23	23 cm (9")

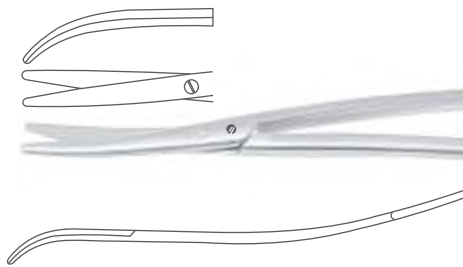

**UltraCut™ TC Fomon Nasal Scissor**

**ULTRA.Cut™**

Catalog #	Size
SS-939-15	14.5 cm (5 3/4")

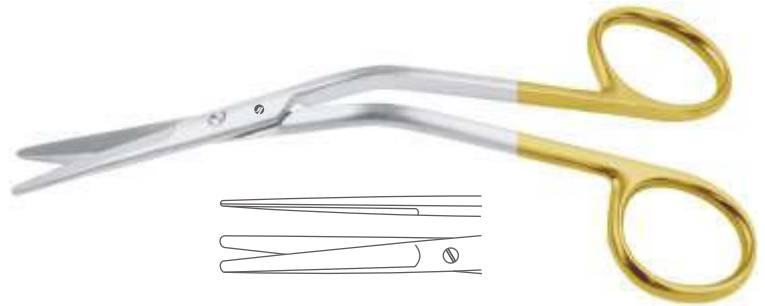

**UltraCut™ TC Cottle Nasal Scissor**

**ULTRA.Cut™**

Catalog #	Size
SS-941-16	16 cm (6 1/4")

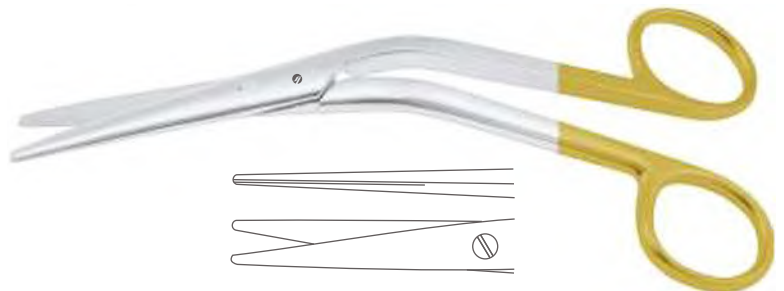



Face-lift Scissors  
Face-lift-Scheren  
Tijeras para Face-Lift  
Ciseaux pour Face-lift  
Forbici per Face-lift

**UltraCut™ TC Gorney Face-Lift Scissor**  
Straight, One Toothed Cutting Edge

**ULTRACut™**

Catalog #	Size
SS-944-20	20 cm (8")
SS-944-23	23 cm (9")



**UltraCut™ TC Rees Face-Lift Scissor**  
Curved, One Toothed Cutting Edge

**ULTRACut™**

Catalog #	Size
SS-947-17	17 cm (6 3/4")



**UltraCut™ TC Gregory Face-Lift Scissor**  
One Toothed Cutting Edge

**ULTRACut™**

Catalog #	Size
SS-949-14	14 cm (5 1/2")

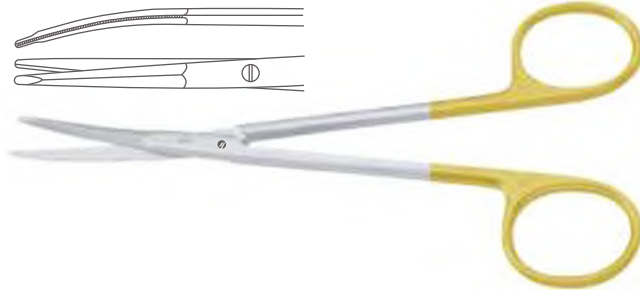

**UltraCut™ TC Kaye Face-Lift Scissor**  
One Toothed Cutting Edge

**ULTRACut™**

Catalog #	Size
SS-951-15	15 cm (6")
SS-951-18	18 cm (7")



**UltraCut™ TC Stella-S Face-Lift Scissor**  
S Shaped, One Toothed Cutting Edge

**ULTRACut™**

Catalog #	Size
SS-953-18	18 cm (7")







Face-lift Scissors  
Face-lift-Scheren  
Tijeras para Face-Lift  
Ciseaux pour Face-lift  
Forbici per Face-lift

**UltraCut™ TC Gorney Face-Lift Scissor**  
One Toothed Cutting Edge

**ULTRA.Cut™**

Catalog #	Size
SS-959-18	18 cm (7")

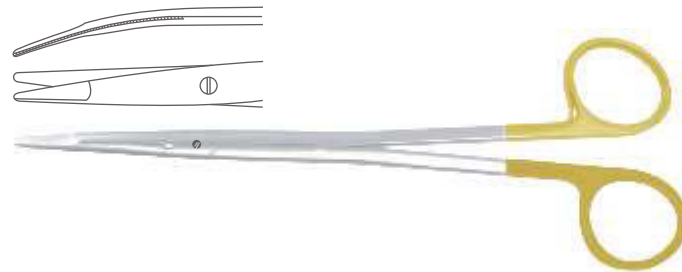

**UltraCut™ TC Freeman-Kaye Face-Lift Scissor**  
One Toothed Cutting Edge

**ULTRA.Cut™**

Catalog #	Size
SS-961-18	18 cm (7")
SS-963-23	23 cm (9")

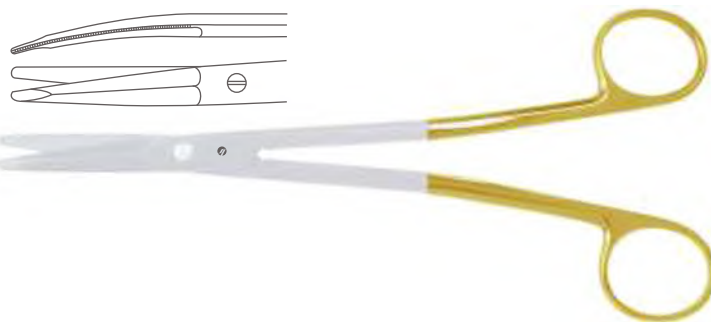

**UltraCut™ TC Wertheim Gynecological Scissor**  
Curved

**ULTRA.Cut™**

Catalog #	Size
SS-965-23	23 cm (9")
SS-965-35	35 cm (14")



**UltraCut™ TC Sims Gynecological Scissor**  
Straight

**ULTRA.Cut™**

Catalog #	Size
SS-968-23	23 cm (9")



**UltraCut™ TC Sims Uterine Scissor**  
Curved

**ULTRA.Cut™**

Catalog #	Size
SS-969-23	23 cm (9")





Hysterectomy Scissors  
Hysterektomiescheren  
Tijeras para histerectomía  
Ciseaux à hystérectomie  
Forbici per isterectomia

**UltraCut™ TC Parametrium Hysterectomy Scissor**  
Strongly Curved

**ULTRACut™**

Catalog #	Size
SS-971-01	22.5 cm (8 ¾")



**UltraCut™ TC Parametrium Hysterectomy Scissor**  
Curved

**ULTRACut™**

Catalog #	Size
SS-971-02	23 cm (9")

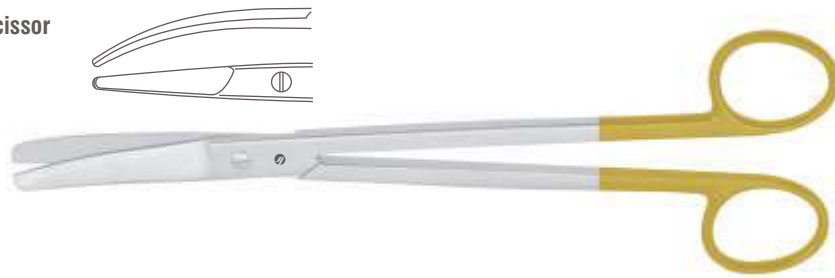

**UltraCut™ TC Stevens Tenotomy Scissor**  
Straight, Blunt/Blunt

**ULTRACut™**

Catalog #	Size
SS-972-10	10.5 cm (4 ¼")
SS-972-11	11.5 cm (4 ½")

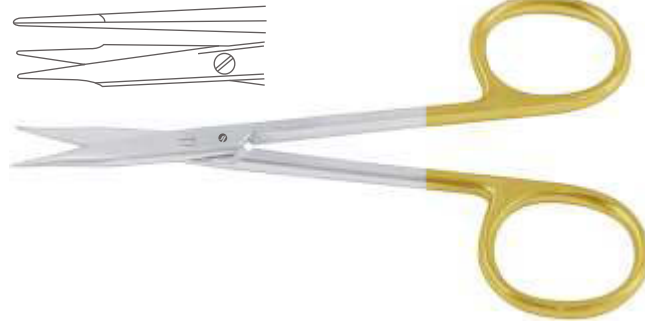

**UltraCut™ TC Stevens Tenotomy Scissor**  
Curved, Blunt/Blunt

**ULTRACut™**

Catalog #	Size
SS-973-10	10.5 cm (4 ¼")
SS-973-11	11.5 cm (4 ½")

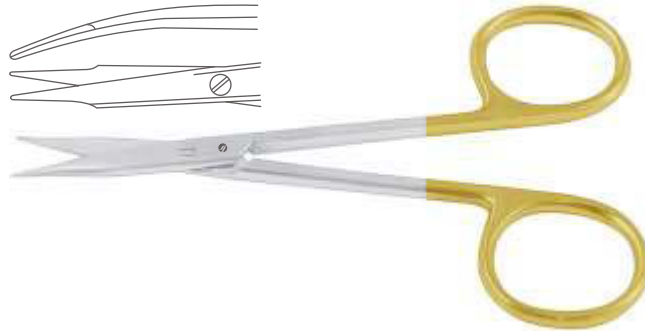

**UltraCut™ TC Stevens Tenotomy Scissor**  
Straight, Sharp/Sharp

**ULTRACut™**

Catalog #	Size
SS-974-10	10.5 cm (4 ¼")
SS-974-11	11.5 cm (4 ½")

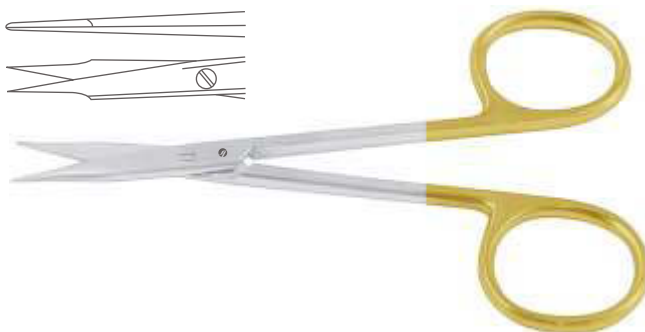



Iris Scissors  
Irisscheren  
Tijeras para iridectomía  
Ciseaux à iridectomie  
Forbici per iridectomia

**UltraCut™ TC Stevens Tenotomy Scissor**  
Curved, Sharp/Sharp

**ULTRA.Cut™**

Catalog #	Size
SS-975-10	10.5 cm (4 ¼")
SS-975-11	11.5 cm (4 ½")

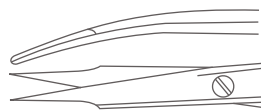

**UltraCut™ TC Goldman-Fox Gum Scissor**  
Straight

**ULTRA.Cut™**

Catalog #	Size
SS-976-13	13 cm (5")



**UltraCut™ TC Goldman-Fox Gum Scissor**  
Curved

**ULTRA.Cut™**

Catalog #	Size
SS-977-13	13 cm (5")



**UltraCut™ TC Iris Scissor**  
Straight

**ULTRA.Cut™**

Catalog #	Size
SS-978-11	11.5 cm (4 ½")



**XTSCut™ TC Iris Scissor**  
Straight

**XTS.Cut™**

Catalog #	Size
SS-978-11 SC	11.5 cm (4 ½")





Iris Scissors  
Irisscheren  
Tijeras para iridectomia  
Ciseaux à iridectomie  
Forbici per iridectomia

**UltraCut™ TC Iris Scissor**  
Curved



Catalog #	Size
SS-979-11	11.5 cm (4 1/2")

**XTSCut™ TC Iris Scissor**  
Curved



Catalog #	Size
SS-979-11 SC	11.5 cm (4 1/2")

**UltraCut™ TC DeBakey Vascular Scissor**

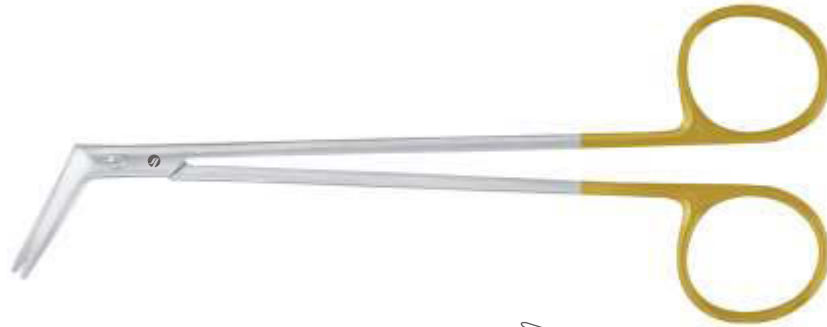

Catalog #	Size
SS-981-25	19 cm (7 1/2")
SS-981-45	18.5 cm (7 1/4")
SS-981-60	18 cm (7")

Catalog #	Size
SS-983-25	23 cm (9")
SS-983-45	23 cm (9")
SS-983-60	22 cm (8 3/4")

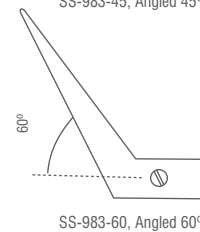
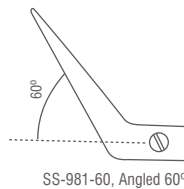
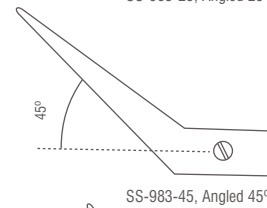
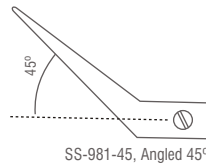
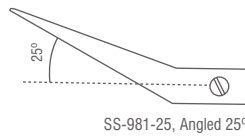



Iris Scissors  
Irissscheren  
Tijeras para iridectomía  
Ciseaux à iridectomie  
Forbici per iridectomia

**UltraCut™ TC Iris Scissor**  
Angled

**ULTRA.Cut™**

Catalog #	Size
SS-985-11	11 cm (4 1/2")

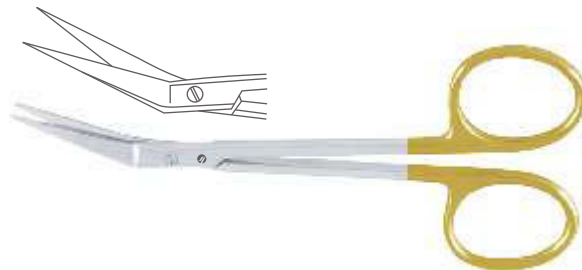

**UltraCut™ TC Ragnell (Kilner) Dissecting Scissor**  
Curved

**ULTRA.Cut™**

Catalog #	Size
SS-987-12	12.5 cm (5")
SS-987-15	15 cm (6")
SS-987-18	18 cm (7")

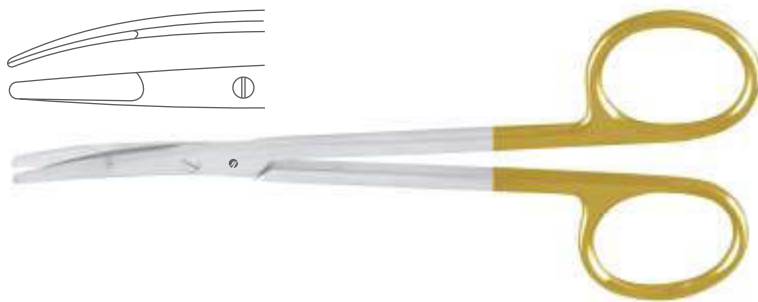

**UltraCut™ TC Kelly Dissecting Scissor**  
Straight

**ULTRA.Cut™**

Catalog #	Size
SS-988-16	16 cm (6 1/4")

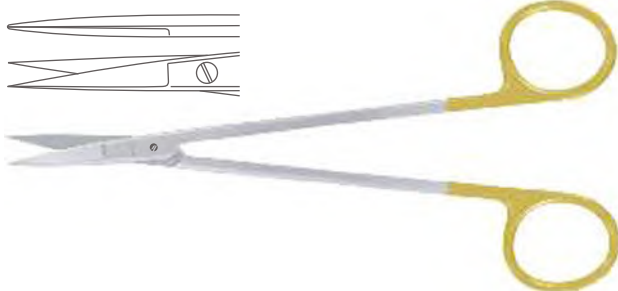

**UltraCut™ TC Kelly Dissecting Scissor**  
Curved

**ULTRA.Cut™**

Catalog #	Size
SS-989-16	16 cm (6 1/4")

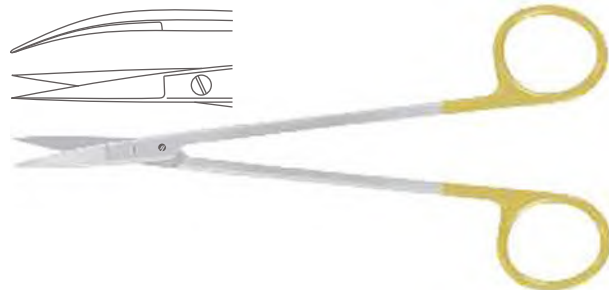

**UltraCut™ TC Universal Wire Cutting Scissor**  
Angled One Toothed Cutting Edge

**ULTRA.Cut™**

Catalog #	Size
SS-991-12	12.5 cm (5")

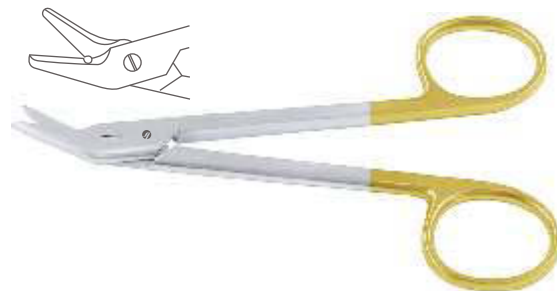



Dissecting Scissors, Gum Scissors  
Präparierscheren, Zahnfleischscheren  
Tijeras de disección, Tijeras para encías  
Ciseaux à dissection, Ciseaux à gencives  
Forbici per dissezione, Forbici per gengiva

**UltraCut™ TC Dean Tonsil Scissor**  
S Shaped, One Toothed Cutting Edge

**ULTRACut™**

Catalog #	Size
SS-993-17	17.5 cm (7")

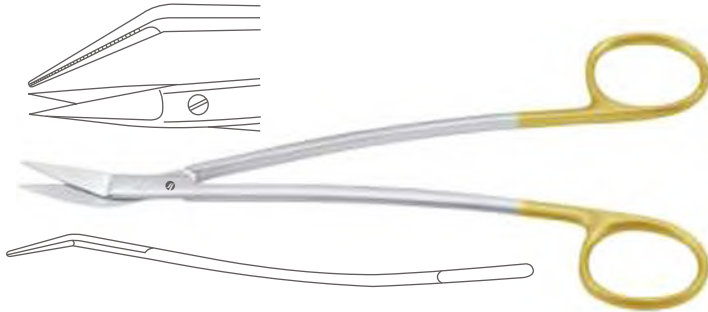

**UltraCut™ TC Locklin Gum Scissor**  
Angled, One Toothed Cutting Edge

**ULTRACut™**

Catalog #	Size
SS-995-16	16 cm (6 1/4")



**UltraCut™ TC Locklin Gum Scissor**  
Angled, S Shaped, One Toothed Cutting Edge

**ULTRACut™**

Catalog #	Size
SS-997-16	16 cm (6 1/4")



**UltraCut™ TC Lister Bandage Scissor**  
Angled

**ULTRACut™**

Catalog #	Size
SS-999-18	18 cm (7")

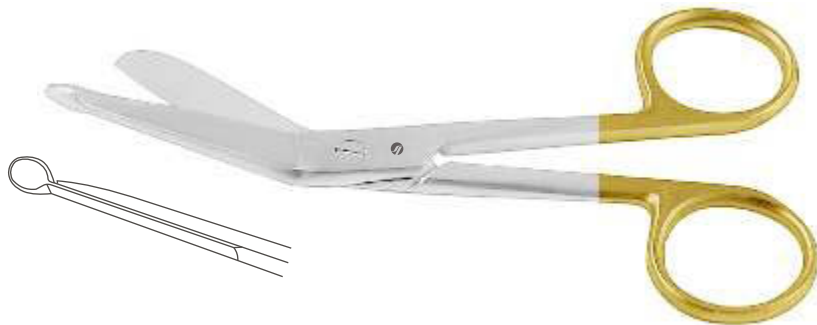







**SURTEX**  
INSTRUMENTS

*Crafted to Excellence*



FR

## FORCEPS

Surtex forceps are characterized by their tactile feel and overall balance. At Surtex we realize that our forceps are the extension of the surgeons thumb and forefinger and need to grasp and release with the same sensitivity as real fingertips. Our Master craftsmen with a wealth of experience adjust the spring pressure in order to obtain the tension and feel required to precisely control the instrument without tiring the surgeon's hand.

Each aspect of the design for forceps needs to be optimized to ensure perfect handling. The teeth are sharp and durable, shanks designed for feeling balance, handles where required are serrated for perfect grip, spring part is calibrated to offer the surgeon exact fingertip feeling, instrument junction is precision welded, serrations where required are well-defined for superb grip & perfect alignment and tips are well rounded and smooth.

Surtex premium grade forceps feature  **DINN-N-DUST™** coating where the working end of the jaws are coated with a ultra fine layer of diamond dust the result is a high wear resistance surface which provides firm reliable grip for holding sutures, needles and tissue.

Forceps featuring **ULTRAGrip<sup>®</sup>** technology have jaw inserts that are engineered by grinding individual teeth into hard wear resistant tungsten carbide to produce a precise, sharp, well-defined point with superb gripping properties.

Pinzetten

Pinzas

Pince

Pinze



Dissecting Forceps  
Anatomische Pinzetten  
Pinzas de disección  
Pinces à dissection  
Pinze per dissezione

**Standard Pattern Dressing Forcep**  
Straight, Serrated

Catalog #	Size
FR-010-10	10.5 cm (4 1/4")
FR-010-11	11.5 cm (4 1/2")
FR-010-13	13 cm (5")
FR-010-14	14.5 cm (5 3/4")
FR-010-16	16 cm (6 1/4")
FR-010-18	18 cm (7")
FR-010-20	20 cm (8")
FR-010-23	23 cm (9")
FR-010-25	25 cm (9 3/4")
FR-010-30	30.5 cm (12")



**Slender Pattern Dressing Forcep**  
Straight, Serrated

Catalog #	Size
FR-012-11	12 cm (4 3/4")
FR-012-13	13 cm (5")
FR-012-14	14.5 cm (5 3/4")
FR-012-16	16 cm (6 1/4")
FR-012-18	18 cm (7")
FR-012-20	20 cm (8")
FR-012-25	25 cm (9 3/4")
FR-012-30	30 cm (11 3/4")



**Slender Pattern Dressing Forcep**  
Curved, Serrated

Catalog #	Size
FR-013-13	13 cm (5")
FR-013-14	14 cm (5 1/2")

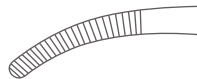



Dissecting Forceps  
Anatomische Pinzetten  
Pinzas de disección  
Pinces à dissection  
Pinze per dissezione

FR

FORCEPS

**Fine Pattern Dressing Forcep**  
Curved, Serrated

Catalog #	Size
FR-016-13	13 cm (5")
FR-016-14	14.5 cm (5 3/4")
FR-016-16	16 cm (6 1/4")
FR-016-18	18 cm (7")



**Modell. USA Dressing Forcep**  
Straight, Serrated

Catalog #	Size
FR-020-12	12 cm (4 3/4")
FR-020-13	13 cm (5")
FR-020-14	14.5 cm (5 3/4")
FR-020-16	16 cm (6 1/4")
FR-020-18	18 cm (7")
FR-020-20	20 cm (8")
FR-020-23	23 cm (9")
FR-020-25	25 cm (9 3/4")
FR-020-30	30 cm (11 3/4")



**Modell. USA Slender Pattern Dressing Forcep**  
Straight, Serrated

Catalog #	Size
FR-022-12	12 cm (4 3/4")
FR-022-13	13 cm (5")
FR-022-14	14.5 cm (5 3/4")
FR-022-16	16 cm (6 1/4")



**Stille Dressing Forcep**  
Round Tips

Catalog #	Size
FR-030-15	15 cm (6")





Dissecting Forceps  
Anatomische Pinzetten  
Pinzas de disección  
Pinces à dissection  
Pinze per dissezione

**Stille Dressing Forcep**  
Square Tips



Catalog #	Size
FR-035-15	15 cm (6")
FR-035-17	17 cm (6 3/4")
FR-035-20	20 cm (8")

**Adson Dressing Forcep**

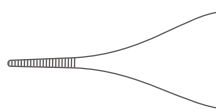

Catalog #	Size
FR-050-12	12 cm (4 3/4")
FR-050-15	15 cm (6")

**Mini Adson Dressing Forcep**  
Cross Serrated Tips

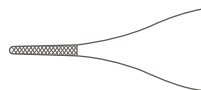

Catalog #	Size
FR-052-12	12 cm (4 3/4")

**Micro Adson Dressing Forcep**

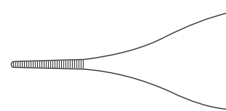

Catalog #	Size
FR-054-12	12 cm (4 3/4")
FR-054-15	15 cm (6")

**McIndoe Dressing Forcep**



Catalog #	Size
FR-060-15	15 cm (6")

INCHES  
MILLIMETERS



Dissecting Forceps  
Anatomische Pinzetten  
Pinzas de disección  
Pinces à dissection  
Pinze per dissezione

**Semken Dressing Forcep**



Catalog #	Size
FR-070-12	12.5 cm (5")
FR-070-15	15 cm (6")

**Taylor Dressing Forcep**



Catalog #	Size
FR-074-17	17 cm (6 3/4")

**Taylor Dressing Forcep  
With Dissector End**



Catalog #	Size
FR-076-17	17 cm (6 3/4")

**Taylor Dressing Forcep  
Bayonet Shaped, With Dissector End**



Catalog #	Size
FR-078-17	18.5 cm (7 1/4")

**Turner Micro Dressing Forcep**



Catalog #	Size
FR-080-06	15.5 cm (6"), 0.6 mm
FR-080-08	15.5 cm (6"), 0.8 mm
FR-080-10	15.5 cm (6"), 1.0 mm



Dissecting Forceps  
Anatomische Pinzetten  
Pinzas de disección  
Pinces à dissection  
Pinze per dissezione

**Gerald Dressing Forcep**  
Straight



Catalog #	Size
FR-084-17	17.5 cm (7")
FR-084-23	23 cm (9")

**Gerald Dressing Forcep**  
Curved

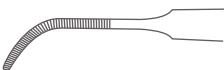

Catalog #	Size
FR-085-17	17.5 cm (7")

**Cushing Dressing Forcep**  
Straight



Catalog #	Size
FR-090-17	17.5 cm (7")
FR-090-20	20 cm (8")
FR-090-25	25 cm (9 3/4")

**Cushing Dressing Forcep**  
Curved

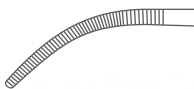

Catalog #	Size
FR-091-17	17.5 cm (7")

**Potts-Smith Dressing Forcep**



Catalog #	Size
FR-094-18	18 cm (7")
FR-094-21	21 cm (8 1/4")
FR-094-25	24.5 (9 3/4")
FR-094-30	30 cm (11 3/4")



Dissecting Forceps  
Anatomische Pinzetten  
Pinzas de disección  
Pinces à dissection  
Pinze per dissezione

**Dressing Forcep**



Catalog #	Size
FR-096-15	15.5 cm (6")

**Gillies Dressing Forcep**



Catalog #	Size
FR-100-15	15 cm (6")

**Waugh Dressing Forcep**

Cross Serrated



Catalog #	Size
FR-102-20	20 cm (8")

**Brophy Dressing Forcep**

Straight



Catalog #	Size
FR-104-20	20 cm (8")

**Brophy Dressing Forcep**

Curved



Catalog #	Size
FR-105-20	20 cm (8")





Dissecting Forceps  
Anatomische Pinzetten  
Pinzas de disección  
Pinces à dissection  
Pinze per dissezione

**Cooley Dressing Forcep**  
Cross Serrated Jaws



Catalog #	Size
FR-108-20	20 cm (8")

**Dressing Forcep**  
Angled



Catalog #	Size
FR-111-20	20 cm (8")

**Ochsner Dressing Forcep**  
Longitudinal Serrations

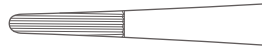

Catalog #	Size
FR-114-14	14.5 cm (5 3/4")

**Bonney Dressing Forcep**

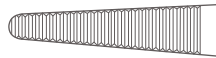

Catalog #	Size
FR-116-17	17.5 cm (7")

**Ramsey Dressing Forcep**

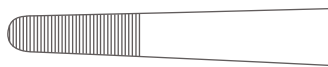

Catalog #	Size
FR-118-18	18 cm (7")



**Standard Pattern Dissecting Forcep**  
Straight, 1 x 2 Teeth

Catalog #	Size
FR-200-10	10.5 cm (4 1/4")
FR-200-11	11.5 cm (4 1/2")
FR-200-13	13 cm (5")
FR-200-14	14.5 cm (5 3/4")
FR-200-16	16 cm (6 1/4")
FR-200-18	18 cm (7")
FR-200-20	20 cm (8")
FR-200-23	23 cm (9")
FR-200-25	25 cm (9 3/4")
FR-200-30	30.5 cm (12")



**Standard Pattern Dissecting Forcep**  
Straight, 2 x 3 Teeth

Catalog #	Size
FR-202-11	12 cm (4 3/4")
FR-202-13	13 cm (5")
FR-202-14	14.5 cm (5 3/4")
FR-202-16	15.5 cm (6")
FR-202-18	18 cm (7")
FR-202-20	20 cm (8")
FR-202-25	24.5 cm (9 3/4")



**Standard Pattern Dissecting Forcep**  
Straight, 3 x 4 Teeth

Catalog #	Size
FR-204-14	14.5 cm (5 3/4")
FR-204-16	16 cm (6 1/4")





Dissecting Forceps  
Anatomische Pinzetten  
Pinzas de disección  
Pinces à dissection  
Pinze per dissezione

**Standard Pattern Dissecting Forcep**  
Straight, 4 x 5 Teeth



Catalog #	Size
FR-206-14	14.5 cm (5 3/4")
FR-206-16	16 cm (6 1/4")



**Slender Pattern Dissecting Forcep**  
Straight, 1 x 2 Teeth



Catalog #	Size
FR-210-13	13 cm (5")
FR-210-14	14.5 cm (5 3/4")
FR-210-16	16 cm (6 1/4")
FR-210-18	18 cm (7")
FR-210-20	20 cm (8")
FR-210-25	25 cm (9 3/4")
FR-210-30	30.5 cm (12")



**Slender Pattern Dissecting Forcep**  
Curved, 1 x 2 Teeth



Catalog #	Size
FR-211-14	14.5 cm (5 3/4")



**Fine Pattern Dissecting Forcep**  
1 x 2 Teeth



Catalog #	Size
FR-214-13	13 cm (5 3/4")
FR-214-14	14.5 cm (5 3/4")
FR-214-16	16 cm (6 1/4")
FR-214-18	18 cm (7")



INCHES  
MILLIMETERS



Dissecting Forceps  
Anatomische Pinzetten  
Pinzas de disección  
Pinces à dissection  
Pinze per dissezione

**Modell. USA Dissecting Forcep**

1 x 2 Teeth

Catalog #	Size
FR-220-12	12 cm (4 3/4")
FR-220-13	13 cm (5")
FR-220-14	14.5 cm (5 3/4")
FR-220-16	16 cm (6 1/4")
FR-220-18	18 cm (7")
FR-220-20	20 cm (8")
FR-220-23	23 cm (9")
FR-220-25	25 cm (9 3/4")
FR-220-30	30 cm (11 3/4")

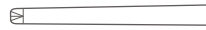

**Modell. USA Dissecting Forcep**

2 x 3 Teeth

Catalog #	Size
FR-222-12	12 cm (4 3/4")
FR-222-13	13 cm (5")
FR-222-14	14.5 cm (5 3/4")
FR-222-16	16 cm (6 1/4")
FR-222-18	18 cm (7")
FR-222-20	20 cm (8")
FR-222-23	23 cm (9")
FR-222-25	25 cm (9 3/4")
FR-222-30	30 cm (11 3/4")

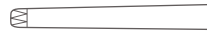

**Modell. USA Slender Pattern Dressing Forcep**

1 x 2 Teeth

Catalog #	Size
FR-224-13	13 cm (5")
FR-224-14	14.5 cm (5 3/4")
FR-224-16	16 cm (6 1/4")

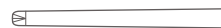



Dissecting Forceps  
Anatomische Pinzetten  
Pinzas de disección  
Pinces à dissection  
Pinze per dissezione

**Stille Dissecting Forcep**

1 x 2 Teeth



Catalog #	Size
FR-230-15	15 cm (6")



**Stille Dissecting Forcep**

2 x 3 Teeth



Catalog #	Size
FR-232-15	15 cm (6")



**Stone Dissecting Forcep**

4 x 5 Teeth

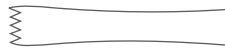

Catalog #	Size
FR-234-15	15 cm (6")



**Lerche Dissecting Forcep**

5 x 6 Teeth



Catalog #	Size
FR-236-15	15 cm (6")



**Adlercreutz Dissecting Forcep**

2 x 3 Teeth



Catalog #	Size
FR-240-15	15.5 cm (6")
FR-240-20	20.5 cm (8")



INCHES  
MILLIMETERS



Dissecting Forceps  
Anatomische Pinzetten  
Pinzas de disección  
Pinces à dissection  
Pinze per dissezione

**Adlercreutz Dissecting Forcep**  
4 x 5 Teeth

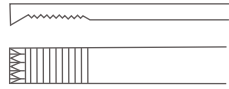

Catalog #	Size
FR-242-15	16 cm (6 1/4")
FR-242-20	20 cm (8")
FR-242-25	25 cm (9 3/4")



**Adson Dissecting Forcep**  
1 x 2 Teeth

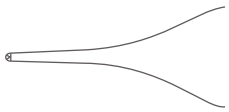

Catalog #	Size
FR-250-12	12 cm (4 3/4")
FR-250-15	15 cm (6")



**Mini-Adson Dissecting Forcep**  
1 x 2 Teeth, Cross Serrated

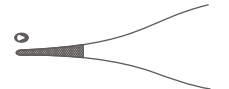

Catalog #	Size
FR-252-12	12 cm (4 3/4")



**Mini-Adson Dissecting Forcep**  
Curved, 1 x 2 Teeth, Cross Serrated



Catalog #	Size
FR-253-12	12 cm (4 3/4")



**Micro-Adson Dissecting Forcep**  
1 x 2 Teeth

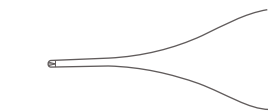

Catalog #	Size
FR-256-12	12 cm (4 3/4")
FR-256-15	15 cm (6")





Dissecting Forceps  
Anatomische Pinzetten  
Pinzas de disección  
Pinces à dissection  
Pinze per dissezione

**Adson-Brown Dissecting Forcep**



Catalog #	Size, Profile
FR-258-12	12 cm (4 3/4"), 7 x 7 Teeth
FR-260-12	12 cm (4 3/4"), 9 x 9 Teeth



**Gillies Dissecting Forcep**

1 x 2 Teeth, Cross Serrated



Catalog #	Size
FR-270-15	15.5 cm (6")



**Waugh Dissecting Forcep**

1 x 2 Teeth, Cross Serrated



Catalog #	Size
FR-272-20	20.5 cm (8")



**Semken Dissecting Forcep**

1 x 2 Teeth



Catalog #	Size
FR-274-12	12.5 cm (5")
FR-274-15	15.5 cm (6")



**Taylor Dissecting Forcep**

1 x 2 Teeth



Catalog #	Size
FR-280-17	17.5 cm (7")







Dissecting Forceps  
Anatomische Pinzetten  
Pinzas de disección  
Pinces à dissection  
Pinze per dissezione

**Taylor Dissecting Forcep**  
1 x 2 Teeth, With Dissector End

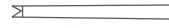

Catalog #	Size
FR-282-17	17 cm (6 3/4")



**Taylor Dissecting Forcep**  
Bayonet Shaped, 1 x 2 Teeth

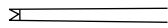

Catalog #	Size
FR-283-17	18.5 cm (7 1/4")



**Dissecting Forcep**  
1 x 2 Teeth

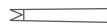

Catalog #	Size
FR-286-06	15.5 cm (6"), 0.6 mm
FR-286-08	15.5 cm (6"), 0.8 mm
FR-286-10	15.5 cm (6"), 1.0 mm



**Gerald Dissecting Forcep**  
Straight, 1 x 2 Teeth



Catalog #	Size
FR-290-17	17.5 cm (7")
FR-290-23	23 cm (9")



**Gerald Dissecting Forcep**  
Curved, 1 x 2 Teeth



Catalog #	Size
FR-291-17	15.5 cm (6")





Dissecting Forceps  
Anatomische Pinzetten  
Pinzas de disección  
Pinces à dissection  
Pinze per dissezione

**Cushing Dissecting Forcep**

1 x 2 Teeth

Catalog #	Size
FR-294-17	18 cm (7")
FR-294-20	20 cm (8")
FR-294-25	25 cm (9 3/4")



**Potts-Smith Dissecting Forcep**

1 x 2 Teeth

Catalog #	Size
FR-296-18	18 cm (7")
FR-296-21	21 cm (8 1/4")
FR-296-25	24 cm (9 1/2")



**McIndoe Dissecting Forcep**

1 x 2 Teeth

Catalog #	Size
FR-298-15	15 cm (6")



**Brophy Dissecting Forcep**

1 x 2 Teeth

Catalog #	Size
FR-300-20	20 cm (8")



**Bonner-Modell Dissecting Forcep**

1 x 2 Teeth, With Plateau

Catalog #	Size
FR-302-09	9.5 cm (3 3/4")





Dissecting Forceps, Jeweller Type Forceps  
Anatomische Pinzetten, Uhrmacher-Pinzetten  
Pinzas de disección, Pinzas de relojero  
Pincas à dissection, Pincas d`horloger  
Pinze per dissezione, Pinze da orologiaio

**Dissecting Forcep**  
1 x 2 Teeth



Catalog #	Size
FR-304-10	10.5 cm (4")



**Jeweller Forcep**  
Fig. 1



Catalog #	Size
FR-310-01	12 cm (5")

**Jeweller Forcep**  
Fig. 2



Catalog #	Size
FR-310-02	12 cm (5")

**Jeweller Forcep**  
Fig. 3



Catalog #	Size
FR-310-03	12 cm (4 3/4")

**Jeweller Forcep**  
Fig. 4



Catalog #	Size
FR-310-04	11 cm (4 1/4")



Jeweller Type Forceps  
Uhrmacher-Pinzetten  
Pinzas de relojero  
Pinces d'horloger  
Pinze da orologiaio

**Jeweller Forcep**  
Fig. 5



Catalog #	Size
FR-310-05	11 cm (4 1/4")

**Jeweller Forcep**  
Fig. 3c



Catalog #	Size
FR-310-13	11 cm (4 1/4")

**Jeweller Forcep**  
Fig. 5a



Catalog #	Size
FR-310-15	11 cm (4 1/4")

**Jeweller Forcep**  
Fig. 5/45°



Catalog #	Size
FR-310-45	10.5 cm (4 1/4")

**Jeweller Forcep**  
Fig. 5/90°

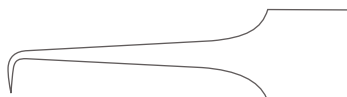

Catalog #	Size
FR-310-90	10.5 cm (4 1/4")



Jeweller Type Forceps  
Uhrmacher-Pinzetten  
Pinzas de relojero  
Pinces d`horloger  
Pinze da orologiaio

**Jeweller Forcep**  
Fig. 7



Catalog #	Size
FR-310-07	12 cm (4 3/4")

**Jeweller Forcep**  
1 x 2 Teeth



Catalog #	Size, Tip Size
FR-313-13	11.5 cm (4 1/2"), 0.4 mm

**Jeweller Forcep**



Catalog #	Size, Tip Size
FR-316-13	13.5 cm (5 1/4"), 0.3 mm

**Jeweller Forcep**  
1 x 2 Teeth

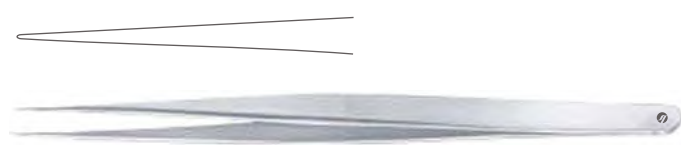

Catalog #	Size, Tip Size
FR-318-13	13.5 cm (5 1/4"), 0.4 mm

**Jeweller Forcep**  
Straight, With Plateau

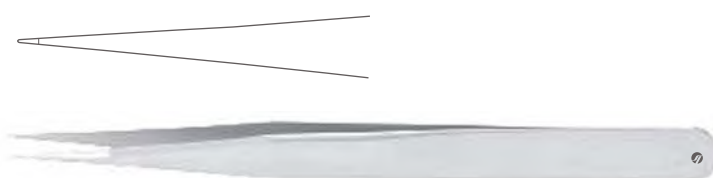

Catalog #	Size, Tip Size
FR-320-12	12 cm (3 3/4"), 0.3 mm



Jeweller Type Forceps, Micro Forceps  
Uhrmacher-Pinzetten, Mikropinzetten  
Pinzas de relojero, Micro Pinzas  
Pincès d'horloger, Micro-Pincès  
Pinze da orologiaio, Micro-Pinze

**Vise Micro Jeweller Forcep**  
Straight, With Plateau



Catalog #	Size, Tip Size
FR-322-13	13.5 cm (5 1/4"), 0.3 mm

**Vise Micro Jeweller Forcep**  
Curved, With Plateau



Catalog #	Size, Tip Size
FR-323-13	13.5 cm (5 1/4"), 0.3 mm

**Micro Vessel Dilator**

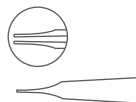

Catalog #	Size, Diameter
FR-325-00	11 cm (4 1/4"), Ø 0.20 mm

**Micro Vessel Dilator**

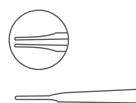

Catalog #	Size, Diameter
FR-325-01	11 cm (4 1/4"), Ø 0.30 mm

**Micro Pierce Forcep**



Catalog #	Size, Diameter
FR-325-02	11 cm (4 1/4"), Ø 0.30 mm

INCHES  
MILLIMETERS



Micro Dilating Forceps, Tissue Forceps  
Gefäß-Dilatationspinzetten, Chirurgische Pinzetten  
Micro pinza de dilatación, Pinzas de disección con diente  
Micro pince à dilater, Pinces à dissection à griffes  
Micro pinze per dilatazione, Pinze per dissezione con denti

**Micro Vessel Dilator**

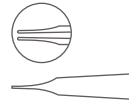

Catalog #	Size, Diameter
FR-327-00	13 cm (5"), Ø 0.20 mm

**Micro Vessel Dilator**

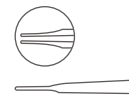

Catalog #	Size, Diameter
FR-327-01	13 cm (5"), Ø 0.30 mm

**Micro Pierce Forcep**



Catalog #	Size, Diameter
FR-327-02	13 cm (5"), Ø 0.30 mm

**Selman Dissecting Forcep**

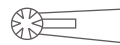

Catalog #	Size
FR-328-15	15.5 cm (6")

**Russian Modell Dissecting Forcep**



Catalog #	Size
FR-330-15	15 cm (5")
FR-330-20	20 cm (8")
Fr-330-25	25.5 cm (10")





Tissue Forceps  
Chirurgische Pinzetten  
Pinzas de disección con diente  
Pincès à dissection à griffes  
Pinze per dissezione con denti

**Durante Dissecting Forcep**



Catalog #	Size
FR-332-14	14.5 cm (5 3/4")
FR-332-16	16 cm (6 1/4")
Fr-332-20	20.5 cm (8")

**Stille-Barraya Dissecting Forcep**



Catalog #	Size
FR-334-18	18 cm (7")
FR-334-20	20 cm (8")
Fr-334-25	25 cm (9 3/4")

**Ferris-Smith Dissecting Forcep**

2 x 3 Teeth

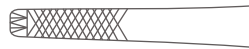

Catalog #	Size
FR-336-18	18 cm (7")



**Bonney Dissecting Forcep**

1 x 2 Teeth



Catalog #	Size
FR-338-18	17.5 cm (7")



**Mayo (Russian) Dissecting Forcep**



Catalog #	Size
FR-340-23	23 cm (9")



Tissue Forceps  
Chirurgische Pinzetten  
Pinzas de disección con diente  
Pinces à dissection à griffes  
Pinze per dissezione con denti

**Singley-Tuttle Dissecting Forcep**

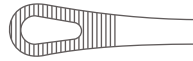

Catalog #	Size
FR-344-18	18 cm (7")
FR-344-23	23 cm (9")

**Collin-Duval Intestinal Forcep**

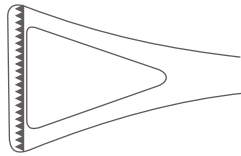

Catalog #	Size, Width
FR-348-14	20 cm (8"), 14.0 mm
FR-348-18	20 cm (8"), 18.0 mm
FR-348-23	20 cm (8"), 23.0 mm

**Duval Intestinal Forcep**

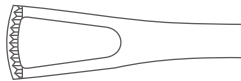

Catalog #	Size
FR-350-14	14 cm (5 1/2")

**Dennis-Browne Intestinal Forcep**



Catalog #	Size
FR-352-19	19 cm (7 1/2")

**Nelson Dissecting Forcep**

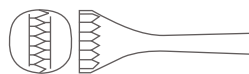

Catalog #	Size
FR-354-23	23 cm (9")



Tissue Forceps  
Chirurgische Pinzetten  
Pinzas de disección con diente  
Pinces à dissection à griffes  
Pinze per dissezione con denti

**Lane Dissecting Forcep**  
1 x 2 Teeth

Catalog #	Size
FR-360-12	12.5 cm (5")
FR-360-14	14.5 cm (5 ¾")
FR-360-17	17.5 cm (7")



**Lane Dissecting Forcep**  
2 x 3 Teeth

Catalog #	Size
FR-362-14	14.5 cm (5 ¾")
FR-362-17	17.5 cm (7")

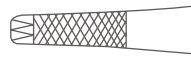

**Treves Dissecting Forcep**  
1 x 2 Teeth

Catalog #	Size
FR-366-12	12.5 cm (5")
FR-366-15	15 cm (6")



**Ramsey Dissecting Forcep**  
1 x 2 Teeth

Catalog #	Size
FR-368-18	18 cm (7")



**Ramsey Dissecting Forcep**  
3 x 4 Teeth

Catalog #	Size
FR-370-18	18 cm (7")

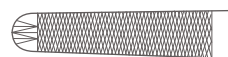



Tissue Forceps, Grasping Forceps  
Chirurgische Pinzetten, Fassungszetten  
Pinzas de disección con diente, Pinzas para coger  
Pinces à dissection à griffes, Pincers pour saisir les tissus  
Pinze per dissezione con denti, Pinze per afferrare tessuti

**Strassburger Modell Dissecting Forcep**

1 x 2 Teeth



Catalog #	Size
FR-374-15	15 cm (6")
FR-374-20	20 cm (8")



**Jackson-Burrows Dissecting Forcep**

1 x 2 Teeth, With Platform



Catalog #	Size
FR-376-14	14 cm (5 1/2")



**Charnley Dissecting Forcep**

1 x 2 Teeth, With Platform



Catalog #	Size
FR-378-18	18 cm (7")



**Samii Tumor Grasping Forcep**

Right, Bayonet Shaped



Catalog #	Size, Tip Diameter
FR-401-01	24 cm (9 1/2"), Ø 3.0 mm

**Samii Tumor Grasping Forcep**

Left, Bayonet Shaped



Catalog #	Size, Tip Diameter
FR-401-02	24 cm (9 1/2"), Ø 3.0 mm



Grasping Forceps  
Fasspinzetten  
Pinzas para coger  
Pinces pour saisir les tissus  
Pinze per afferrare tessuti

**Yasargil Tumor Grasping Forcep**  
Bayonet Shaped

Catalog #	Size, Tip Diameter
FR-403-01	22 cm (8 3/4"), Ø 3.0 mm
FR-403-02	22 cm (8 3/4"), Ø 5.0 mm



**Yasargil Tumor Grasping Forcep**  
Bayonet Shaped

Catalog #	Size, Tip Diameter
FR-403-03	22 cm (8 3/4"), Ø 3.0 mm
FR-403-04	22 cm (8 3/4"), Ø 5.0 mm



**Heifetz Tumor Grasping Forcep**  
Bayonet Shaped

Catalog #	Size, Tip Diameter
FR-405-01	22 cm (8 3/4"), Ø 3.0 mm
FR-405-02	22 cm (8 3/4"), Ø 5.0 mm



**Hunt Tumor Grasping Forcep**  
Angled

Catalog #	Size, Tip Diameter
FR-407-20	20 cm (8"), Ø 5.0 mm





Grasping Forceps  
Fasspinzetten  
Pinzas para coger  
Pinces pour saisir les tissus  
Pinze per afferrare tessuti

**Yasargil Micro Forcep**  
Bayonet Shaped

Catalog #	Size, Tip Size
FR-411-16	16 cm (6 1/4"), 0.6 mm
FR-411-18	18 cm (7"), 0.6 mm
FR-411-20	20 cm (8"), 0.6 mm
FR-411-22	22 cm (8 3/4"), 0.6 mm
FR-411-24	24 cm (9 1/2"), 0.6 mm



**Yasargil Micro Forcep**  
Bayonet Shaped

Catalog #	Size, Tip Size
FR-413-16	16 cm (6 1/4"), 0.9 mm
FR-413-18	18 cm (7"), 0.9 mm
FR-413-20	20 cm (8"), 0.9 mm
FR-413-22	22 cm (8 3/4"), 0.9 mm
FR-413-24	24 cm (9 1/2"), 0.9 mm



**Yasargil Micro Forcep**  
Bayonet Shaped, 1 x 2 Teeth

Catalog #	Size
FR-415-16	16 cm (6 1/4")
FR-415-18	18 cm (7")
FR-415-20	20 cm (8")



**Lazar Micro Suturing Forcep**

Catalog #	Size, Tip Size
FR-420-05	15.5 cm (6"), 0.5 mm
FR-420-08	15.5 cm (6"), 0.8 mm





Micro Forceps  
Mikropinzetten  
Micro Pinzas  
Micro-Pinces  
Micro-Pinze

**Micro Suturing Forcep**  
With Platform



Catalog #	Size, Tip Size
FR-422-18	18.5 cm (7 1/4"), 0.5 mm

**Austin Micro Suturing Forcep**  
With Platform

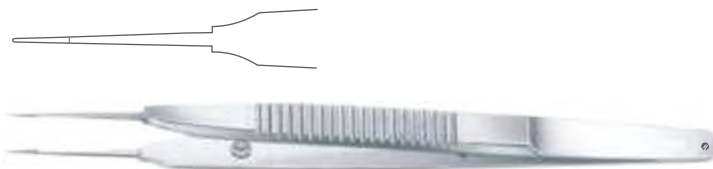

Catalog #	Size, Tip Size
FR-424-14	14 cm (5 1/2"), 0.8 mm

**Micro Suturing Forcep**  
With Platform

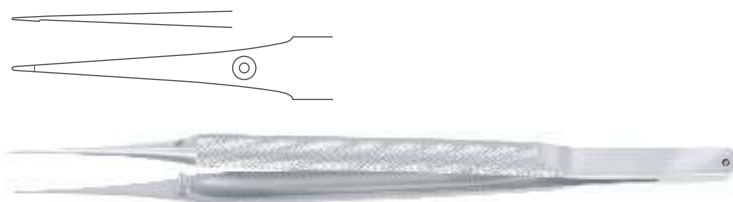

Catalog #	Size, Tip Size
FR-430-12	12 cm (4 3/4"), 0.3 mm
FR-430-15	15 cm (6"), 0.3 mm

**Micro Suturing Forcep**  
Curved, With Platform



Catalog #	Size, Tip Size
FR-431-12	12 cm (4 3/4"), 0.3 mm
FR-431-15	15 cm (6"), 0.3 mm

**Micro Suturing Forcep**  
With Platform

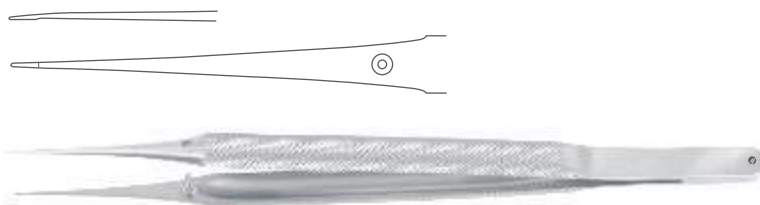

Catalog #	Size, Tip Size
FR-432-18	18 cm (7"), 0.5 mm





Micro Forceps  
Mikropinzetten  
Micro Pinzas  
Micro-Pinces  
Micro-Pinze

**Micro Suturing Forcep**  
Curved, With Platform

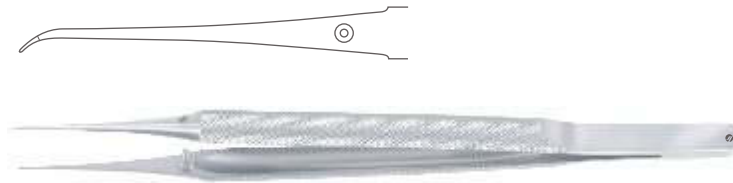

Catalog #	Size, Tip Size
FR-433-18	18 cm (7"), 0.5 mm

**Diam-n-Dust™ Micro Dressing Forcep**  
Straight



Catalog #	Size, Tip Size
FR-500-15	15 cm (6"), 6.0 x 0.4 mm
FR-500-18	18 cm (7"), 6.0 x 0.4 mm

**Diam-n-Dust™ Micro Dressing Forcep**  
Straight, Titanium



Catalog #	Size, Tip Size
FR-500-15 T	15 cm (6"), 6.0 x 0.4 mm
FR-500-18 T	18 cm (7"), 6.0 x 0.4 mm

**Diam-n-Dust™ Micro Dressing Forcep**  
Curved



Catalog #	Size, Tip Size
FR-501-15	15 cm (6"), 6.0 x 0.4 mm
FR-501-18	18 cm (7"), 6.0 x 0.4 mm

**Diam-n-Dust™ Micro Dressing Forcep**  
Curved, Titanium



Catalog #	Size, Tip Size
FR-501-15 T	15 cm (6"), 6.0 x 0.4 mm
FR-501-18 T	18 cm (7"), 6.0 x 0.4 mm



Micro Forceps  
Mikropinzetten  
Micro Pinzas  
Micro-Pinces  
Micro-Pinze

**Diam-n-Dust™ Micro Dressing Forcep**  
Straight



Catalog #	Size, Tip Size
FR-504-15	15 cm (6"), 6.0 x 0.7 mm
FR-504-18	18 cm (7"), 6.0 x 0.7 mm
FR-504-21	21 cm (8 1/4"), 6.0 x 0.7 mm
FR-504-23	23 cm (9"), 6.0 x 0.7 mm



**Diam-n-Dust™ Micro Dressing Forcep**  
Straight, Titanium



Catalog #	Size, Tip Size
FR-504-15 T	15 cm (6"), 6.0 x 0.7 mm
FR-504-18 T	18 cm (7"), 6.0 x 0.7 mm
FR-504-21 T	21 cm (8 1/4"), 6.0 x 0.7 mm



**Diam-n-Dust™ Micro Dressing Forcep**  
Curved



Catalog #	Size, Tip Size
FR-505-15	15 cm (6"), 6.0 x 0.7 mm
FR-505-18	18 cm (7"), 6.0 x 0.7 mm
FR-505-21	21 cm (8 1/4"), 6.0 x 0.7 mm
FR-505-23	23 cm (9"), 6.0 x 0.7 mm



**Diam-n-Dust™ Micro Dressing Forcep**  
Curved, Titanium



Catalog #	Size, Tip Size
FR-505-15 T	15 cm (6"), 6.0 x 0.7 mm
FR-505-18 T	18 cm (7"), 6.0 x 0.7 mm
FR-505-21 T	21 cm (8 1/4"), 6.0 x 0.7 mm





**Diam-n-Dust™ Micro Dissecting Forcep**  
Straight, 1 x 2 Teeth



Catalog #	Size, Tip Size
FR-508-15	15 cm (6"), 6.0 x 0.4 mm
FR-508-18	18 cm (7"), 6.0 x 0.4 mm

**Diam-n-Dust™ Micro Dissecting Forcep**  
Straight, 1 x 2 Teeth, Titanium



Catalog #	Size, Tip Size
FR-508-15 T	15 cm (6"), 6.0 x 0.4 mm
FR-508-18 T	18 cm (7"), 6.0 x 0.4 mm

**Diam-n-Dust™ Micro Dissecting Forcep**  
Curved, 1 x 2 Teeth



Catalog #	Size, Tip Size
FR-509-15	15 cm (6"), 6.0 x 0.4 mm
FR-509-18	18 cm (7"), 6.0 x 0.4 mm

**Diam-n-Dust™ Micro Dissecting Forcep**  
Curved, 1 x 2 Teeth, Titanium



Catalog #	Size, Tip Size
FR-509-15 T	15 cm (6"), 6.0 x 0.4 mm
FR-509-18 T	18 cm (7"), 6.0 x 0.4 mm



Micro Forceps  
Mikropinzetten  
Micro Pinzas  
Micro-Pinces  
Micro-Pinze

**Diam-n-Dust™ Micro Dissecting Forcep**  
Straight, 1 x 2 Teeth



Catalog #	Size, Tip Size
FR-512-15	15 cm (6"), 6.0 x 0.7 mm
FR-512-18	18 cm (7"), 6.0 x 0.7 mm
FR-512-21	21 cm (8 1/4"), 6.0 x 0.7 mm
FR-512-23	23 cm (9"), 6.0 x 0.7 mm



**Diam-n-Dust™ Micro Dissecting Forcep**  
Straight, 1 x 2 Teeth, Titanium



Catalog #	Size, Tip Size
FR-512-15 T	15 cm (6"), 6.0 x 0.7 mm
FR-512-18 T	18 cm (7"), 6.0 x 0.7 mm
FR-512-21 T	21 cm (8 1/4"), 6.0 x 0.7 mm



**Diam-n-Dust™ Micro Dissecting Forcep**  
Curved, 1 x 2 Teeth



Catalog #	Size, Tip Size
FR-513-15	15 cm (6"), 6.0 x 0.7 mm
FR-513-18	18 cm (7"), 6.0 x 0.7 mm
FR-513-21	21 cm (8 1/4"), 6.0 x 0.7 mm
FR-513-23	23 cm (9"), 6.0 x 0.7 mm

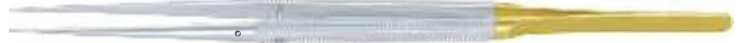

**Diam-n-Dust™ Micro Dissecting Forcep**  
Curved, 1 x 2 Teeth, Titanium



Catalog #	Size, Tip Size
FR-513-15 T	15 cm (6"), 6.0 x 0.7 mm
FR-513-18 T	18 cm (7"), 6.0 x 0.7 mm
FR-513-21 T	21 cm (8 1/4"), 6.0 x 0.7 mm





**Diam-n-Dust™ Micro Ring Forcep**



Catalog #	Size, Tip Diameter
FR-516-15	15 cm (6"), Ø 1.0 x 0.5 mm
FR-516-18	18 cm (7"), Ø 1.0 x 0.5 mm
FR-516-21	21 cm (8 ¼"), Ø 1.0 x 0.5 mm
FR-516-23	23 cm (9"), Ø 1.0 x 0.5 mm



**Diam-n-Dust™ Micro Ring Forcep**  
Titanium



Catalog #	Size, Tip Diameter
FR-516-15 T	15 cm (6"), Ø 1.0 x 0.5 mm
FR-516-18 T	18 cm (7"), Ø 1.0 x 0.5 mm
FR-516-21 T	21 cm (8 ¼"), Ø 1.0 x 0.5 mm



**Diam-n-Dust™ Micro Ring Forcep**



Catalog #	Size, Tip Diameter
FR-518-15	15 cm (6"), Ø 2.0 x 1.0 mm
FR-518-18	18 cm (7"), Ø 2.0 x 1.0 mm
FR-518-21	21 cm (8 ¼"), Ø 2.0 x 1.0 mm
FR-518-23	23 cm (9"), Ø 2.0 x 1.0 mm



**Diam-n-Dust™ Micro Ring Forcep**  
Titanium



Catalog #	Size, Tip Diameter
FR-518-15 T	15 cm (6"), Ø 2.0 x 1.0 mm
FR-518-18 T	18 cm (7"), Ø 2.0 x 1.0 mm
FR-518-21 T	21 cm (8 ¼"), Ø 2.0 x 1.0 mm





Micro Forceps  
Mikropinzetten  
Micro Pinzas  
Micro-Pinces  
Micro-Pinze

**Micro Atrauma Forcep**

Catalog #	Size, Tip Size
FR-520-15	15 cm (6"), 1.2 mm
FR-520-18	18 cm (7"), 1.2 mm
FR-520-21	21 cm (8 1/4"), 1.2 mm



**Micro Atrauma Forcep**  
Titanium

Catalog #	Size, Tip Size
FR-520-15 T	15 cm (6"), 1.2 mm
FR-520-18 T	18 cm (7"), 1.2 mm
FR-520-21 T	21 cm (8 1/4"), 1.2 mm



**Diam-n-Dust™ Micro Suturing Forcep**  
Straight



Catalog #	Size, Diameter
FR-522-00	15 cm (6"), Ø 0.4 mm



**Diam-n-Dust™ Micro Suturing Forcep**  
Curved



Catalog #	Size, Diameter
FR-522-01	15 cm (6"), Ø 0.4 mm



**Diam-n-Dust™ Micro Suturing Forcep**  
Angled



Catalog #	Size, Diameter
FR-522-02	15 cm (6"), Ø 0.4 mm





**Diam-n-Dust™ Micro Ring Forcep**



Catalog #	Size, Tip Diameter
FR-522-03	15 cm (6"), Ø 1.0 x 0.5 mm

**Micro Vessel Dilator**



Catalog #	Size, Tip Diameter
FR-522-04	15 cm (6"), Ø 0.3 mm

**Micro Pierce Forcep**



Catalog #	Size, Tip Diameter
FR-522-05	15 cm (6"), Ø 0.4 mm

**Diam-n-Dust™ Micro Suturing Forcep  
Straight**



Catalog #	Size, Tip Diameter
FR-524-00	18 cm (7"), Ø 0.4 mm

**Diam-n-Dust™ Micro Suturing Forcep  
Curved**



Catalog #	Size, Tip Diameter
FR-524-01	18 cm (7"), Ø 0.4 mm





Micro Forceps  
Mikropinzetten  
Micro Pinzas  
Micro-Pinces  
Micro-Pinze

**Diam-n-Dust™ Micro Suturing Forcep**  
Angled



Catalog #	Size, Tip Diameter
FR-524-02	18 cm (7"), Ø 0.4 mm



**Diam-n-Dust™ Micro Ring Forcep**



Catalog #	Size, Tip Diameter
FR-524-03	18 cm (7"), Ø 1.0 x 0.5 mm



**Micro Vessel Dilator**

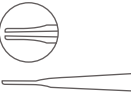

Catalog #	Size, Tip Diameter
FR-524-04	18 cm (7"), Ø 0.3 mm



**Micro Pierce Forcep**

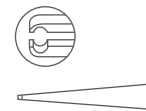

Catalog #	Size, Tip Diameter
FR-524-05	18 cm (7"), Ø 0.4 mm



**Micro Vessel Dilator**  
With Counter Balance



Catalog #	Size, Tip Diameter
FR-526-00	15 cm (6"), Ø 0.3 mm





Micro Forceps  
Mikropinzetten  
Micro Pinzas  
Micro-Pinces  
Micro-Pinze

FR

FORCEPS

**Micro Pierce Forcep**  
With Counter Balance



Catalog #	Size, Tip Diameter
FR-526-01	15 cm (6"), Ø 0.3 mm

**Micro Vessel Dilator**  
With Counter Balance

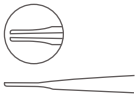

Catalog #	Size, Tip Diameter
FR-528-00	18 cm (7"), Ø 0.3 mm

**Micro Vessel Dilator**  
With Counter Balance



Catalog #	Size, Tip Diameter
FR-528-01	18 cm (7"), Ø 0.3 mm

**Diam-n-Dust™ Micro Ring Forcep**  
Straight, With Counter Balance



DIAM-N-DUST™

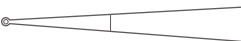

Catalog #	Size, Tip Diameter
FR-530-15	15 cm (6"), Ø 1.0 mm
FR-530-18	18.5 cm (7 1/4"), Ø 1.0 mm
FR-530-21	21 cm (8 1/4"), Ø 1.0 mm
FR-530-23	23 cm (9"), Ø 1.0 mm
FR-530-25	25 cm (9 3/4"), Ø 1.0 mm



Micro Forceps  
Mikropinzetten  
Micro Pinzas  
Micro-Pinces  
Micro-Pinze

**Diam-n-Dust™ Micro Ring Forcep**  
Curved, With Counter Balance



Catalog #	Size, Tip Diameter
FR-531-15	15 cm (6"), Ø 1.0 mm
FR-531-18	18.5 cm (7 ¼"), Ø 1.0 mm
FR-531-21	21 cm (8 ¼"), Ø 1.0 mm
FR-531-23	23 cm (9"), Ø 1.0 mm
FR-531-25	25 cm (9 ¾"), Ø 1.0 mm



**Diam-n-Dust™ Micro Ring Forcep**  
Straight, With Counter Balance



Catalog #	Size, Tip Diameter
FR-534-18	18.5 cm (7 ¼"), Ø 2.0 mm



**Diam-n-Dust™ Micro Suturing Forcep**  
Straight, With Counter Balance



Catalog #	Size
FR-536-15	15 cm (6")
FR-536-18	18.5 cm (7 ¼")
FR-536-21	21 cm (8 ¼")
FR-536-25	25 cm (9 ¾")



**Diam-n-Dust™ Micro Suturing Forcep**  
Curved, With Counter Balance



Catalog #	Size
FR-537-15	15 cm (6")
FR-537-18	18.5 cm (7 ¼")
FR-537-21	21 cm (8 ¼")
FR-537-25	25 cm (9 ¾")





**Micro Atrauma Forcep**  
With Counter Balance



Catalog #	Size, Tip Size
FR-540-18	18.5 cm (7 1/4"), 1.2 mm
FR-540-21	21 cm (8 1/4"), 1.2 mm

**Diam-n-Dust™ Micro Ring Forcep**  
Straight, With Long Platform



Catalog #	Size, Tip Diameter
FR-550-18	18.5 cm (7 1/4"), Ø 1.0 mm
FR-550-21	21 cm (8 1/4"), Ø 1.0 mm

**Diam-n-Dust™ Micro Ring Forcep**  
Curved, With Long Platform



Catalog #	Size, Tip Diameter
FR-551-18	18.5 cm (7 1/4"), Ø 1.0 mm
FR-551-21	21 cm (8 1/4"), Ø 1.0 mm

**Diam-n-Dust™ Micro Ring Forcep**  
Straight, With Short Platform



Catalog #	Size, Tip Diameter
FR-552-18	18.5 cm (7 1/4"), Ø 1.0 mm
FR-552-21	21 cm (8 1/4"), Ø 1.0 mm

**Diam-n-Dust™ Micro Suturing Forcep**  
Straight



Catalog #	Size
FR-554-18	18.5 cm (7 1/4")
FR-554-21	21 cm (8 1/4")



Micro Forceps  
Mikropinzetten  
Micro Pinzas  
Micro-Pinces  
Micro-Pinze

**Micro Atrauma Forcep**  
Straight



Catalog #	Size, Tip Size
FR-556-18	18.5 cm (7 1/4"), 1.2 mm
FR-556-21	21 cm (8 1/4"), 1.2 mm

**Gerald Micro Forcep**  
Cross Serrated Jaws



Catalog #	Size, Tip Size
FR-558-18	18 cm (7"), 1.0 mm
FR-558-25	25 cm (9 3/4"), 1.0 mm

**Gerald (DeBakey) Micro Atrauma Forcep**



Catalog #	Size, Tip Size
FR-560-18	18 cm (7"), 1.0 mm
FR-560-21	20 cm (8"), 1.0 mm

**Diam-n-Dust™ Gerald Micro Ring Forcep**  
Straight



Catalog #	Size, Tip Diameter
FR-562-18	18 cm (7"), Ø 1.0 mm

**Diam-n-Dust™ Gerald Micro Ring Forcep**  
Curved



Catalog #	Size, Tip Diameter
FR-563-18	18 cm (7"), Ø 1.0 mm



Micro Forceps, Vascular Forceps  
Mikropinzetten, Gefäßpinzetten  
Micro Pinzas, Pinzas de disección vascular  
Micro-Pinces, Pinces à dissection vasculaires  
Micro-Pinze, Pinze per dissezione vascolari

**Diam-n-Dust™ Gerald Micro Suturing Forcep**



Catalog #	Size, Tip Size
FR-566-18	18 cm (7"), 1.0 mm
FR-566-20	20 cm (8"), 1.0 mm

**Micro Dressing Forcep**  
Cross Serrated Jaws



Catalog #	Size
FR-568-20	20 cm (8")

**DeBakey Atrauma Forcep**  
Ultra Light Pattern



Catalog #	Size, Tip Size
FR-580-15	15 cm (6"), 1.2 mm

**DeBakey Atrauma Forcep**  
Ultra Light Pattern



Catalog #	Size, Tip Size
FR-582-20	20 cm (8"), 1.5 mm
FR-582-24	24 cm (9 1/2"), 1.5 mm
FR-582-30	30 cm (11 3/4"), 1.5 mm

**DeBakey Atrauma Forcep**



Catalog #	Size, Tip Size
FR-584-15	15 cm (6"), 1.0 mm
FR-584-20	20 cm (8"), 1.0 mm
FR-584-24	24 cm (9 1/2"), 1.0 mm



Vascular Forceps  
Gefäßpinzetten  
Pinzas de disección vascular  
Pinces à dissection vasculaires  
Pinze per dissezione vascolari

**DeBakey Atrauma Forcep**

Catalog #	Size, Tip Size
FR-590-16	16 cm (6 1/4"), 1.5 mm
FR-590-20	20 cm (8"), 1.5 mm
FR-590-24	24.5 cm (9 3/4"), 1.5 mm
FR-590-30	30 cm (11 3/4"), 1.5 mm



**DeBakey Atrauma Forcep**  
Titanium

Catalog #	Size, Tip Size
FR-590-16 T	16 cm (6 1/4"), 1.5 mm
FR-590-20 T	20 cm (8"), 1.5 mm
FR-590-24 T	24.5 cm (9 3/4"), 1.5 mm



**DeBakey Atrauma Forcep**

Catalog #	Size, Tip Size
FR-592-16	16 cm (6 1/4"), 2.0 mm
FR-592-20	20 cm (8"), 2.0 mm
FR-592-24	24.5 cm (9 3/4"), 2.0 mm
FR-592-30	30 cm (11 3/4"), 2.0 mm



**DeBakey Atrauma Forcep**  
Titanium

Catalog #	Size, Tip Size
FR-592-16 T	16 cm (6 1/4"), 2.0 mm
FR-592-20 T	20 cm (8"), 2.0 mm
FR-592-24 T	24.5 cm (9 3/4"), 2.0 mm







Vascular Forceps  
Gefäßpinzetten  
Pinzas de disección vascular  
Pinces à dissection vasculaires  
Pinze per dissezione vascolari

**DeBakey Atrauma Forcep**  
Angled

Catalog #	Size, Tip Size
FR-593-16	16 cm (6 ¼"), 2.0 mm
FR-593-20	19.5 cm (7 ¾"), 2.0 mm
FR-593-24	24.5 cm (9 ¾"), 2.0 mm
FR-593-30	29.5 cm (11 ½"), 2.0 mm



**DeBakey Atrauma Forcep**

Catalog #	Size, Tip Size
FR-594-16	16 cm (6 ¼"), 2.8 mm
FR-594-20	20 cm (8"), 2.8 mm
FR-594-24	24.5 cm (9 ¾"), 2.8 mm
FR-594-30	30 cm (11 ¾"), 2.8 mm



**DeBakey Atrauma Forcep**

Catalog #	Size, Tip Size
FR-596-16	16 cm (6 ¼"), 3.5 mm
FR-596-20	20 cm (8"), 3.5 mm
FR-596-24	24.5 cm (9 ¾"), 3.5 mm
FR-596-30	30 cm (11 ¾"), 3.5 mm



**Cooley Atrauma Forcep**

Catalog #	Size, Tip Size
FR-598-16	16 cm (6 ¼"), 2.0 mm
FR-598-20	20 cm (8"), 2.0 mm
FR-598-24	24 cm (9 ½"), 2.0 mm





Splinter Forceps  
Splitterpinzetten  
Pinzas para espinas  
Pincas à échardes  
Pinze per scheggie

**Splinter Forcep**  
Straight, Smooth Jaws

Catalog #	Size
FR-600-10	10 cm (4")
FR-600-12	12.5 cm (5")



**Splinter Forcep**  
Curved, Smooth Jaws

Catalog #	Size
FR-601-12	12.5 cm (5")



**Splinter Forcep**  
Angled, Smooth Jaws

Catalog #	Size
FR-603-10	10 cm (4")



**Splinter Forcep**  
Straight, Serrated Jaws

Catalog #	Size
FR-606-09	9 cm (3 1/2")
FR-606-10	10.5 cm (4")
FR-606-11	11.5 cm (4 1/2")
FR-606-13	13 cm (5")
FR-606-14	14.5 cm (5 3/4")





Splinter Forceps  
Splitterpinzetten  
Pinzas para espinas  
Pincas à échardes  
Pinze per scheggie

**Splinter Forcep**  
Curved, Serrated Jaws

Catalog #	Size
FR-607-09	9 cm (3 1/2")
FR-607-10	10.5 cm (4")
FR-607-11	11.5 cm (4 1/2")
FR-607-13	12.5 cm (5")
FR-607-14	14.5 cm (5 3/4")



**Feilchenfeld Splinter Forcep**

Catalog #	Size
FR-610-07	7.5 cm (3 1/4")
FR-610-09	9 cm (3 1/2")
FR-610-11	11.5 cm (4 1/2")



**Hunter Splinter Forcep**  
Straight

Catalog #	Size
FR-612-10	10.5 cm (4")



**Hunter Splinter Forcep**  
Curved

Catalog #	Size
FR-613-10	10.5 cm (4")



**Shaaf Splinter Forcep**

Catalog #	Size
FR-620-09	9.5 cm (3 3/4")





Splinter Forceps  
Splitterpinzetten  
Pinzas para espinas  
Pinces à échardes  
Pinze per scheggie

**Littauer Cilia Forcep**  
Smooth Jaws



Catalog #	Size
FR-622-08	8.5 cm (3 1/4")

**Bergh Cilia Forcep**  
Serrated Jaws



Catalog #	Size
FR-624-09	8.5 cm (3 1/4")

**Douglas Cilia Forcep**  
Narrow Tip



Catalog #	Size
FR-626-09	9 cm (3 1/2")

**Douglas Cilia Forcep**  
Wide Tip



Catalog #	Size
FR-628-09	9 cm (3 1/2")

**Beer Cilia Forcep**  
Smooth Jaws



Catalog #	Size
FR-630-09	9 cm (3 1/2")

INCHES  
MILLIMETERS



Splinter Forceps  
Splitterpinzetten  
Pinzas para espinas  
Pinces à échardes  
Pinze per scheggie

**Barraquer Cilia Forcep**  
Smooth Jaws



Catalog #	Size
FR-632-10	10.5 cm (4")

**Stieglitz Splinter Forcep**  
Straight

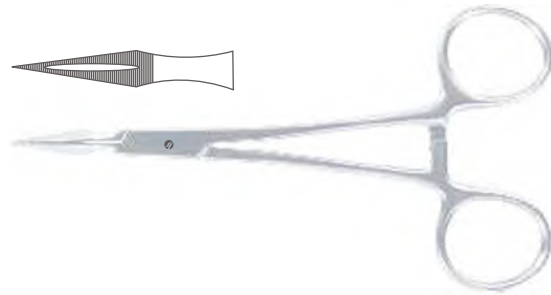

Catalog #	Size
FR-650-14	14 cm (5 1/2")

**Stieglitz Splinter Forcep**  
Curved

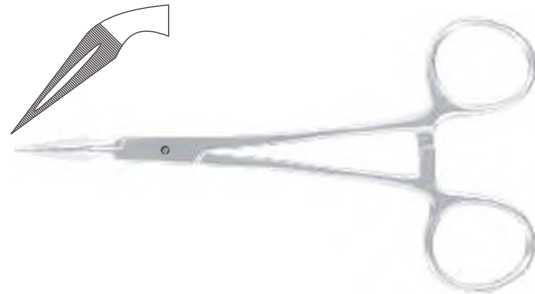

Catalog #	Size
FR-651-14	13.5 cm (5 1/4")

**Peet Splinter Forcep**



Catalog #	Size
FR-655-11	12.5 cm (5")

**Ralk Splinter Forcep**  
Straight



Catalog #	Size
FR-660-15	15 cm (6")



Eye Surgery Forceps  
Augenchirurgie Pinzetten  
Ojo Pinzas Cirugia  
Pince de chirurgie oculaire  
Eye Pinze Chirurgia

**Ralk Splinter Forcep**  
Curved



Catalog #	Size
FR-661-15	15 cm (6")

**Graefe Eye Dressing Forcep**  
Straight



Catalog #	Size
FR-700-01	10 cm (4")

**Graefe Eye Dressing Forcep**  
Gently Curved



Catalog #	Size
FR-700-02	10 cm (4")

**Graefe Eye Dressing Forcep**  
Strongly Curved



Catalog #	Size
FR-700-03	9.5 cm (3 3/4")

**Graefe Dissecting Forcep**  
Straight, 1 x 2 Teeth



Catalog #	Size
FR-702-01	10 cm (4")





Eye Surgery Forceps  
Augenchirurgie Pinzetten  
Ojo Pinzas Cirugia  
Pince de chirurgie oculaire  
Eye Pinze Chirurgia

**Graefe Dissecting Forcep**  
Gently Curved, 1 x 2 Teeth

Catalog #	Size
FR-702-02	10 cm (4")



**Graefe Dissecting Forcep**  
Strongly Curved, 1 x 2 Teeth

Catalog #	Size
FR-702-03	9.5 cm (3 3/4")



**Botvin Iris Forcep**  
Serrated

Catalog #	Size
FR-710-07	7.5 cm (3 1/4")



**Botvin Iris Forcep**  
1 x 2 Teeth

Catalog #	Size
FR-712-07	7.5 cm (3 1/4")



**Gills-Colibri Corneal Forcep**  
Very Fine Pointed Tips With Tying Platform

Catalog #	Size
FR-714-07	7.5 cm (3 1/4")







Eye Surgery Forceps  
Augenchirurgie Pinzetten  
Ojo Pinzas Cirugia  
Pince de chirurgie oculaire  
Eye Pinze Chirurgia

**Colibri Corneal Forcep**  
Very Delicate 1 x 2 Teeth



Catalog #	Size, Tip Size
FR-716-07	7.5 cm (3 1/4"), 0.12 mm



**Harms-Colibri Corneal Forcep**  
Very Delicate 1 x 2 Teeth With Tying Platform



Catalog #	Size, Tip Size
FR-718-07	7.5 cm (3 1/4"), 0.12 mm



**Harms-Colibri Corneal Forcep**  
Very Delicate 1 x 2 Teeth With Tying Platform, Titanium



Catalog #	Size, Tip Size
FR-718-07 T	7.5 cm (3 1/4"), 0.12 mm



**Colibri Corneal Forcep**  
Standard 1 x 2 Teeth With Tying Platform



Catalog #	Size, Tip Size
FR-720-07	7.5 cm (3 1/4"), 0.4 mm



**Pierce-Colibri Corneal Forcep**  
1 x 1 Teeth



Catalog #	Size, Tip Size
FR-721-07	7.5 cm (3 1/4"), 0.1 mm





Eye Surgery Forceps  
Augenchirurgie Pinzetten  
Ojo Pinzas Cirugia  
Pince de chirurgie oculaire  
Eye Pinze Chirurgia

**Hoskins Tissue Forcep**

Straight, 1 x 1 Teeth



Catalog #	Size
FR-722-08	8 cm (3 1/4")



**Hoskins Tissue Forcep**

Curved, 1 x 1 Teeth



Catalog #	Size
FR-723-08	8 cm (3 1/4")



**Fechtner Conjunctival Forcep**

Very Delicate Ring Shaped Tips With Tying Platform



Catalog #	Size
FR-724-10	10.5 cm (4")

**Gastroviejo-Colibri Corneal Forcep**

Very Delicate 1 x 2 Teeth



Catalog #	Size, Tip Size
FR-726-11	11 cm (4 1/4"), 0.12 mm



**Harms-Colibri Corneal Forcep**

Very Delicate 1 x 2 Teeth With Tying Platform

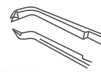

Catalog #	Size, Tip Size
FR-728-11	11 cm (4 1/4"), 0.12 mm





Eye Surgery Forceps  
Augenchirurgie Pinzetten  
Ojo Pinzas Cirugia  
Pince de chirurgie oculaire  
Eye Pinze Chirurgia

**Bonn Corneal Forcep**  
Very Delicate 1 x 2 Teeth



Catalog #	Size, Tip Size
FR-730-08	8.5 cm (3 1/4"), 0.12 mm



**Bonn Corneal Forcep**  
Very Delicate 1 x 2 Teeth With Tying Platform



Catalog #	Size, Tip Size
FR-732-10	10 cm (4"), 0.12 mm



**Bonn Corneal Forcep**  
Very Delicate 1 x 2 Teeth With Tying Platform, Titanium



Catalog #	Size, Tip Size
FR-732-10 T	10 cm (4"), 0.12 mm



**McPherson Suture Tying Forcep**  
Straight, 1 x 2 Teeth With Tying Platform



Catalog #	Size, Tip Size
FR-736-10	10.5 cm (4"), 0.4 mm



**McPherson Suture Tying Forcep**  
Angled, 1 x 2 Teeth With Tying Platform



Catalog #	Size, Tip Size
FR-737-10	10 cm (4"), 0.4 mm





Eye Surgery Forceps  
Augenchirurgie Pinzetten  
Ojo Pinzas Cirugia  
Pince de chirurgie oculaire  
Eye Pinze Chirurgia

**Kelman-McPherson Tissue Forcep**  
1 x 2 Teeth



Catalog #	Size, Jaw Length, Tip Size
FR-740-10	10 cm (4"), 8 mm, 0.3 mm



**Hoffer-McPherson Tissue Forcep**  
Very Delicate 1 x 2 Teeth



Catalog #	Size, Jaw Length, Tip Size
FR-742-10	10 cm (4"), 11 mm, 0.12 mm



**Castroviejo Suture Tying Forcep**  
1 x 2 Teeth With Tying Platform



Catalog #	Size, Tip Size
FR-750-01	11 cm (4 1/4"), 0.12 mm
FR-750-03	11 cm (4 1/4"), 0.3 mm
FR-750-05	11 cm (4 1/4"), 0.5 mm
FR-750-09	11 cm (4 1/4"), 0.9 mm



**Castroviejo Suture Tying Forcep**  
1 x 2 Teeth With Tying Platform, Titanium



Catalog #	Size, Tip Size
FR-750-01 T	11 cm (4 1/4"), 0.12 mm



**Castroviejo Suture Tying Forcep**  
Angled, 1 x 2 Teeth With Tying Platform



Catalog #	Size, Tip Size
FR-751-01	11 cm (4 1/4"), 0.12 mm
FR-751-03	11 cm (4 1/4"), 0.3 mm
FR-751-05	11 cm (4 1/4"), 0.5 mm
FR-751-09	11 cm (4 1/4"), 0.9 mm





Eye Surgery Forceps  
Augenchirurgie Pinzetten  
Ojo Pinzas Cirugia  
Pince de chirurgie oculaire  
Eye Pinze Chirurgia

**Castroviejo Suture Tying Forcep**  
Angled, 1 x 2 Teeth With Tying Platform, Titanium

Catalog #	Size, Tip Size
FR-751-01 T	11 cm (4 1/4"), 0.12 mm



**Girard Corneoscleral Forcep**  
1 x 2 Teeth With Tying Platform, For Right Hand

Catalog #	Size, Tip Size
FR-754-10	10.5 cm (4"), 0.12 mm



**Girard Corneoscleral Forcep**  
1 x 2 Teeth With Tying Platform, For Left Hand

Catalog #	Size, Tip Size
FR-756-10	10.5 cm (4"), 0.12 mm



**Bishop-Harmon Iris Forcep**  
Delicate 1 x 2 Teeth

Catalog #	Size
FR-758-08	8.5 cm (3 1/4")



**Bishop-Harmon Iris Forcep**  
Standard 1 x 2 Teeth

Catalog #	Size
FR-760-08	8.5 cm (3 1/4")





Eye Surgery Forceps  
Augenchirurgie Pinzetten  
Ojo Pinzas Cirugia  
Pince de chirurgie oculaire  
Eye Pinze Chirurgia

**Bishop-Harmon Dressing Forcep**

Cross Serrated Jaws

Catalog #	Size
FR-762-09	8.5 cm (3 1/4")



**Sauer Fixation Forcep**

1 x 2 Teeth

Catalog #	Size, Tip Size
FR-766-09	9 cm (3 1/2"), 0.3 mm



**Manhattan Eye & Ear Fixation Forcep**

1 x 2 Teeth With Tying Platform

Catalog #	Size, Tip Size
FR-768-09	9 cm (3 1/2"), 0.3 mm



**Elschnig Fixation Forcep**

1 x 2 Teeth

Catalog #	Size
FR-770-11	11 cm (4 1/4")



**Graefe Fixation Forcep**

Catalog #	Size
FR-772-11	11 cm (4 1/4")





Eye Surgery Forceps  
Augenchirurgie Pinzetten  
Ojo Pinzas Cirugia  
Pince de chirurgie oculaire  
Eye Pinze Chirurgia

**Troutman Superior Rectus Forcep**  
Angled, 1 x 2 Teeth



Catalog #	Size
FR-774-11	11 cm (4 1/4")

**McPherson Suture Tying Forcep**  
Straight, With Tying Platform



Catalog #	Size, Jaw Length
FR-780-10	10 cm (4"), 5 mm

**McPherson Suture Tying Forcep**  
Straight, With Tying Platform, Titanium



Catalog #	Size, Jaw Length
FR-780-10 T	10 cm (4"), 5 mm

**McPherson Suture Tying Forcep**  
Angled, With Tying Platform



Catalog #	Size, Jaw Length
FR-781-10	10 cm (4"), 5 mm

**McPherson Suture Tying Forcep**  
Angled, With Tying Platform, Titanium



Catalog #	Size, Jaw Length
FR-781-10 T	10 cm (4"), 5 mm





Eye Surgery Forceps  
Augenchirurgie Pinzetten  
Ojo Pinzas Cirugia  
Pince de chirurgie oculaire  
Eye Pinze Chirurgia

**Kelman-McPherson Suture Tying Forcep**  
Angled, With Tying Platform

Catalog #	Size, Jaw Length
FR-784-10	10 cm (4"), 7.5 mm



**Kelman-McPherson Suture Tying Forcep**  
Angled, With Tying Platform, Titanium

Catalog #	Size, Jaw Length
FR-784-10 T	10 cm (4"), 7.5 mm



**Kurstin Flap Stretching Forcep**  
Disc Shaped, Serrated Jaws

Catalog #	Size
FR-790-10	10.5 cm (4")



**Buratto LASIK Flap Forcep**  
Curved, Disc Shaped, Serrated Jaws

Catalog #	Size
FR-793-10	10.5 cm (4")



**Mendez Multipurpose LASIK Forcep**  
Angled, Spatulated Jaws & Tips

Catalog #	Size
FR-795-10	10 cm (4")





Eye Surgery Forceps  
Augenchirurgie Pinzetten  
Ojo Pinzas Cirugia  
Pince de chirurgie oculaire  
Eye Pinze Chirurgia

**Kraff Capsule Tag Forcep**  
Angled



Catalog #	Size, Shank Length, Jaw Length
FR-797-10	10.5 cm (4"), 11 mm, 1.5 mm

**Utrata Capsulorhexis Forcep**  
Very Delicate Triangular Grasping Tips, Extremely Thin



Catalog #	Size, Shank Length
FR-801-10	10.5 cm (4"), 11 mm

**Utrata Capsulorhexis Forcep**  
Very Delicate Triangular Grasping Tips, Extremely Thin, Titanium

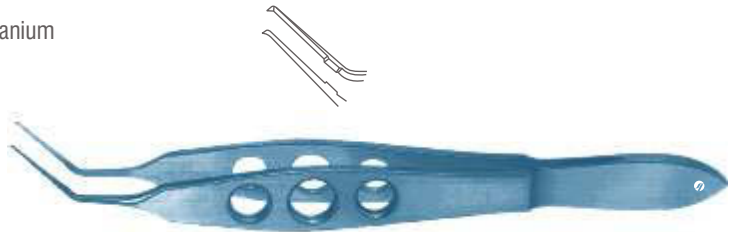

Catalog #	Size, Shank Length
FR-801-10 T	10.5 cm (4"), 11 mm

**Jaffe Capsulorhexis Forcep**  
Very Delicate Round Grasping Tips, Extremely Thin



Catalog #	Size, Shank Length
FR-803-10	10.5 cm (4"), 11 mm

**Jaffe Suture Tying Forcep**  
Straight, Very Delicate Smooth Jaws



Catalog #	Size, Jaw Length
FR-810-10	10.5 cm (4"), 6 mm



Eye Surgery Forceps  
Augenchirurgie Pinzetten  
Ojo Pinzas Cirugia  
Pince de chirurgie oculaire  
Eye Pinze Chirurgia

**Jaffe Suture Tying Forcep**  
Curved, Very Delicate Smooth Jaws



Catalog #	Size, Jaw Length
FR-811-10	10.5 cm (4"), 6 mm

**Tennant Suture Tying Forcep**  
Straight, Round Handle With Guide Pin, Extra Delicate Smooth Jaws



Catalog #	Size, Jaw Length
FR-816-10	10.5 cm (4"), 6 mm

**Tennant Suture Tying Forcep**  
Straight, Round Handle With Guide Pin, Extra Delicate Smooth Jaws, Titanium



Catalog #	Size, Jaw Length
FR-816-10 T	10.5 cm (4"), 6 mm

**Tennant Suture Tying Forcep**  
Curved, Round Handle With Guide Pin, Extra Delicate Smooth Jaws



Catalog #	Size, Jaw Length
FR-817-10	10.5 cm (4"), 6 mm

**Tennant Suture Tying Forcep**  
Curved, Round Handle With Guide Pin, Extra Delicate Smooth Jaws, Titanium



Catalog #	Size, Jaw Length
FR-817-10 T	10.5 cm (4"), 6 mm



Eye Surgery Forceps  
Augenchirurgie Pinzetten  
Ojo Pinzas Cirugia  
Pince de chirurgie oculaire  
Eye Pinze Chirurgia

**Harms Suture Tying Forcep**  
Straight



Catalog #	Size
FR-820-10	10.5 cm (4")

**Harms Suture Tying Forcep**  
Curved



Catalog #	Size
FR-821-10	10.5 cm (4")

**Helveston Suture Tying Forcep**  
Straight



Catalog #	Size
FR-824-10	10.5 cm (4")

**Fine Suture Tying Forcep**  
Curved



Catalog #	Size
FR-825-10	10.5 cm (4")

**Gerl Suture Tying Forcep**  
Smooth Jaws, Curved Shank



Catalog #	Size, Jaw Length
FR-827-08	8.5 cm (3 1/4"), 6 mm



Eye Surgery Forceps  
Augenchirurgie Pinzetten  
Ojo Pinzas Cirugia  
Pince de chirurgie oculaire  
Eye Pinze Chirurgia

**Gerl Suture Tying Forcep**

Smooth Jaws, Curved Shank, Titanium



Catalog #	Size, Jaw Length
FR-827-08 T	8.5 cm (3 1/4"), 6 mm

**Gradle Cilia Forcep**

Smooth Jaws



Catalog #	Size
FR-830-10	10 cm (4")

**Bonaccolto Conjunctival Forcep**

Longitudinal Serrated Jaws With Cross Serrated Tips



Catalog #	Size, Tip Size
FR-834-12	10.5 cm (4"), 1.2 mm
FR-834-17	10.5 cm (4"), 1.7 mm

**Moorfield Conjunctival Forcep**



Catalog #	Size
FR-838-10	10 cm (4")

**Nugent Utility Forcep**

Smooth Jaws



Catalog #	Size
FR-840-10	10.5 cm (4")



Eye Surgery Forceps  
Augenchirurgie Pinzetten  
Ojo Pinzas Cirugia  
Pince de chirurgie oculaire  
Eye Pinze Chirurgia

**Nugent Utility Forcep**  
Serrated Jaws



Catalog #	Size
FR-842-10	10.5 cm (4")

**Gold Punctal Plug Forcep**  
With Longitudinal Groove, Pointed Tips



Catalog #	Size
FR-846-10	11 cm (4 1/4")

**Osher Iris Forcep**  
Very Fine Textured Jaws



Catalog #	Size
FR-848-11	11 cm (4 1/4")

**Foreign Body Forcep**  
Straight



Catalog #	Size
FR-850-11	8.5 cm (3 1/4")

**Jaffe Utility Forcep**  
Curved, Very Delicate Smooth Jaws



Catalog #	Size
FR-855-11	11 cm (4 1/4")



Eye Surgery Forceps  
Augenchirurgie Pinzetten  
Ojo Pinzas Cirugia  
Pince de chirurgie oculaire  
Eye Pinze Chirurgia

**Arruga Capsule Forcep**



Catalog #	Size
FR-859-11	11 cm (4 1/4")

**Akahoshi Phaco PreChopper**

Delicate Jaws With Sharp Tips



Catalog #	Size, Jaw Length
FR-861-11	11 cm (4 1/4"), 4.5 mm

**Ernest Nucleus Cracker**

Extra Delicate Cross Action Serrated Paddle Tips



Catalog #	Size
FR-863-11	11 cm (4 1/4")

**Dodick Nucleus Cracker**

Cross Action, Longitudinally Serrated Paddle Shaped Jaws



Catalog #	Size
FR-867-11	11 cm (4 1/4")

**Alfonso Nucleus Grasping Forcep**

With Two Short Rows off Delicate Interlocking Teeth



Catalog #	Size
FR-869-10	10.5 cm (4")





Eye Surgery Forceps  
Augenchirurgie Pinzetten  
Ojo Pinzas Cirugia  
Pince de chirurgie oculaire  
Eye Pinze Chirurgia

**Rosenwasser Donor Lamella Inserting Forcep**  
With Vaulted Shanks

Catalog #	Size
FR-871-11	11 cm (4 1/4")



**Dodick IOL Folding Forcep**  
For Short IOLs

Catalog #	Size
FR-875-11	11 cm (4 1/4")



**Livernois IOL Folding Forcep**  
Concave Jaw Surfaces, For Soft IOLs

Catalog #	Size
FR-877-10	10.5 cm (4")



**Steinert IOL Inserting Forcep**  
Conically Shaped Jaws

Catalog #	Size
FR-879-10	10 cm (4")



**Livernois IOL Holding Forcep**  
Straight, Highly Polished Round Jaws For Holding Soft IOLs

Catalog #	Size
FR-882-10	10.5 cm (4")





Eye Surgery Forceps  
Augenchirurgie Pinzetten  
Ojo Pinzas Cirugia  
Pince de chirurgie oculaire  
Eye Pinze Chirurgia

**Livernois IOL Holding Forcep**

Curved, Highly Polished Round Jaws For Holding Soft IOLs



Catalog #	Size
FR-883-10	10.5 cm (4")

**Livernois-McDonald IOL Inserting Forcep**

Concave Jaws



Catalog #	Size, Jaw Length
FR-885-10	10.5 cm (4"), 5.0 mm

**Faulkner Lens Holding Forcep**

Round, Smooth Jaws



Catalog #	Size
FR-887-10	10 cm (4")

**Buratto IOL Inserting Forcep**

Extra Delicate Highly Polished Convex Jaws, For Soft IOLs



Catalog #	Size
FR-889-10	10 cm (4")

**Bechert Lens Holding Forcep**

Very Delicate Flat Jaws



Catalog #	Size
FR-891-12	12.5 cm (5")



Eye Surgery Forceps  
Augenchirurgie Pinzetten  
Ojo Pinzas Cirugia  
Pince de chirurgie oculaire  
Eye Pinze Chirurgia

**Kratz Lens Holding Forcep**  
Very Delicate Narrow Jaws

Catalog #	Size
FR-893-12	12.5 cm (5")



**Blaydes Lens Holding Forcep**  
Very Delicate Narrow Jaws, Angled 45°

Catalog #	Size
FR-895-11	11.5 cm (4 1/2")



**Shepard Lens Holding Forcep**  
Gently Curved, Duckbill Shaped Jaws

Catalog #	Size
FR-897-12	12.5 cm (5")



**Clayman Lens Holding Forcep**  
Gently Curved Blades with Delicately Angled Jaws

Catalog #	Size
FR-899-12	12.5 cm (5")



**Jameson Muscle Forcep**  
Right, with Slide Lock, 4 Teeth, Child Size

Catalog #	Size
FR-901-01	9.5 cm (3 3/4")





Eye Surgery Forceps  
Augenchirurgie Pinzetten  
Ojo Pinzas Cirugia  
Pince de chirurgie oculaire  
Eye Pinze Chirurgia

**Jameson Muscle Forcep**

Left, with Slide Lock, 4 Teeth, Child Size

Catalog #	Size
FR-901-02	9.5 cm (3 ¾")



**Jameson Muscle Forcep**

Right, with Slide Lock, 6 Teeth, Adult Size

Catalog #	Size
FR-903-01	10 cm (4")



**Jameson Muscle Forcep**

Left, with Slide Lock, 6 Teeth, Adult Size

Catalog #	Size
FR-903-02	10 cm (4")



**Berke Ptosis Forcep**

Longitudinally Grooved Jaws, with Side Lock

Catalog #	Size, Jaw Length
FR-905-20	11 cm (4 ¼"), 20 mm



**Berke Ptosis Forcep**

Longitudinally Grooved Jaws, with Side Lock

Catalog #	Size, Jaw Length
FR-905-27	11 cm (4 ¼"), 27 mm





Eye Surgery Forceps  
Augenchirurgie Pinzetten  
Ojo Pinzas Cirugia  
Pince de chirurgie oculaire  
Eye Pinze Chirurgia

**Erhardt Lid Forcep**



Catalog #	Size
FR-908-10	10.5 cm (4")

**Downes Lid Clamp**



Catalog #	Size
FR-910-09	9.5 cm (3 3/4")

**Lambert Chalazion Forcep**

Round Jaws



Catalog #	Size, Jaw Diameter
FR-912-08	9 cm (3 1/2"), Ø 8.0 mm

**Hunt Chalazion Forcep**

Round Jaws



Catalog #	Size, Jaw Diameter
FR-912-12	9.5 cm (3 3/4"), Ø 12.0 mm

**Baird Chalazion Forcep**

Small, Oval Jaws



Catalog #	Size, Jaw Size
FR-914-09	9.5 cm (3 3/4"), 11 x 8 mm



Eye Surgery Forceps  
Augenchirurgie Pinzetten  
Ojo Pinzas Cirugia  
Pince de chirurgie oculaire  
Eye Pinze Chirurgia

**Francis Chalazion Forcep**  
Medium, Oval Jaws

Catalog #	Size, Jaw Size
FR-916-09	9.5 cm (3 ¾"), 14 x 11 mm



**Desmarres Chalazion Forcep**  
Large, Oval Jaws

Catalog #	Size, Jaw Size
FR-918-09	9.5 cm (3 ¾"), 20 x 13 mm



**Wies Chalazion Forcep**  
Grooved Upper Jaws

Catalog #	Size
FR-920-09	9.5 cm (3 ¾")



**Desmarres Entropian Forcep**  
Right

Catalog #	Size
FR-923-01	10 cm (4")



**Desmarres Entropian Forcep**  
Left

Catalog #	Size
FR-923-02	10 cm (4")





Tissue Forceps, Dissecting Forceps  
Chirurgische Pinzetten, Anatomische Pinzetten  
Pinzas de disección con diente, Pinzas de disección  
Pincès à dissection à griffes, Pincès à dissection  
Pinze per dissezione con denti, Pinze per dissezione

**UltraGrip™ TC Bonney Dissecting Forcep**  
1 x 2 Teeth



Catalog #	Size
FR-940-17	17.5 cm (7")



**UltraGrip™ TC Gerald Dissecting Forcep**  
1 x 2 Teeth



Catalog #	Size
FR-942-17	17.5 cm (7")



**UltraGrip™ TC Gillies Dissecting Forcep**  
1 x 2 Teeth



Catalog #	Size
FR-944-15	15.5 cm (6")



**UltraGrip™ TC McIndoe Dressing Forcep**



Catalog #	Size
FR-946-15	15 cm (6")



**UltraGrip™ TC Semken Dissecting Forcep**  
1 x 2 Teeth



Catalog #	Size
FR-950-16	16 cm (6 1/4")
FR-950-18	18 cm (7")







Tissue Forceps, Dissecting Forceps  
Chirurgische Pinzetten, Anatomische Pinzetten  
Pinzas de disección con diente, Pinzas de disección  
Pincas à dissection à griffes, Pincas à dissection  
Pinze per dissezione con denti, Pinze per dissezione

**UltraGrip™ TC Micro-Semken Dissecting Forcep**

1 x 2 Teeth



Catalog #	Size
FR-952-16	16 cm (6 1/4")
FR-952-18	18 cm (7")



**UltraGrip™ TC Adson-Brown Dissecting Forcep**



Catalog #	Size
FR-956-12	12 cm (4 3/4")

**UltraGrip™ TC Micro-Adson Dissecting Forcep**

1 x 2 Teeth



Catalog #	Size
FR-958-12	12 cm (4 3/4")
FR-958-15	15 cm (6")



**UltraGrip™ TC Adson Dressing Forcep**



Catalog #	Size
FR-960-12	12 cm (4 3/4")
FR-960-15	15 cm (6")

**UltraGrip™ TC Adson Dissecting Forcep**

1 x 2 Teeth

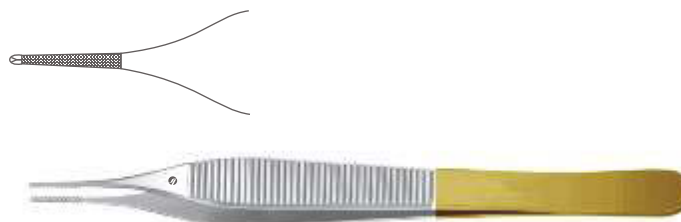

Catalog #	Size
FR-962-12	12 cm (4 3/4")
FR-962-15	15 cm (6")





Tissue Forceps, Dissecting Forceps  
Chirurgische Pinzetten, Anatomische Pinzetten  
Pinzas de disección con diente, Pinzas de disección  
Pincers à dissection à griffes, Pincers à dissection  
Pinze per dissezione con denti, Pinze per dissezione

**UltraGrip™ TC Cushing Dressing Forcep**  
Straight



Catalog #	Size
FR-966-17	17.5 cm (7")
FR-966-21	21 cm (8 ¼")

**UltraGrip™ TC Cushing Dressing Forcep**  
Angled



Catalog #	Size
FR-967-17	17 cm (6 ¾")

**UltraGrip™ TC Cushing-Taylor Dressing Forcep**  
Bayonet Shaped



Catalog #	Size
FR-969-17	18.5 cm (7 ¼")

**UltraGrip™ TC Potts-Smith Dressing Forcep**



Catalog #	Size
FR-972-15	16 cm (6 ¼")
FR-972-18	18.5 cm (7 ¼")
FR-972-20	20 cm (8")
FR-972-23	23 cm (9")
FR-972-25	25 cm (9 ¾")



Tissue Forceps, Dissecting Forceps  
Chirurgische Pinzetten, Anatomische Pinzetten  
Pinzas de disección con diente, Pinzas de disección  
Pincas à dissection à griffes, Pincas à dissection  
Pinze per dissezione con denti, Pinze per dissezione

**UltraGrip™ TC Oehler Dissecting Forcep**

1 x 2 Teeth



Catalog #	Size
FR-974-14	14.5 cm (5 ¾")
FR-974-16	16 cm (6 ¼")
FR-974-18	18 cm (7")
FR-974-20	20 cm (8")
FR-974-25	25 cm (9 ¾")



**UltraGrip™ TC Ferris-Smith Dissecting Forcep**

2 x 3 Teeth



Catalog #	Size
FR-978-17	17.5 cm (7")

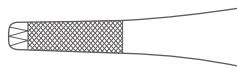

**UltraGrip™ TC Wangenstein Dressing Forcep**



Catalog #	Size
FR-980-15	15 cm (6")
FR-980-23	23 cm (9")



**UltraGrip™ TC DeBakey Atrauma Forcep**



Catalog #	Size, Tip Size
FR-990-16	16 cm (6 ¼"), 1.6 mm
FR-990-20	20 cm (8"), 1.6 mm
FR-990-24	24.5 cm (9 ¾"), 1.6 mm

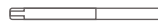

Crafted to Excellence

**SURTEX**  
INSTRUMENTS



Tissue Forceps, Dissecting Forceps  
Chirurgische Pinzetten, Anatomische Pinzetten  
Pinzas de disección con diente, Pinzas de disección  
Pincas à dissection à griffes, Pincas à dissection  
Pinze per dissezione con denti, Pinze per dissezione

### UltraGrip™ TC DeBakey Atrauma Forcep

**ULTRA**Grip™

Catalog #	Size, Tip Size
FR-992-16	16 cm (6 1/4"), 2.0 mm
FR-992-20	20 cm (8"), 2.0 mm
FR-992-24	24.5 cm (9 3/4"), 2.0 mm





**SURTEX**  
INSTRUMENTS

*Crafted to Excellence*



AF

## ARTERY FORCEPS

Surtext artery forceps are manufactured by prime-grade surgical stainless steel by master craftsmen with intricate knowledge and focus on surgeon specific needs. The fine serrations of varying lengths and specifications enable the surgeon to perfectly clamp and restrict arteries or tissue, to control the flow of blood. The perfect alignment of the jaws and smooth round edges help deliver perfect results every time.

Arterienklemmen

Pinzas hemostáticas

Pinces hémostatiques

Pinze emostatiche



Clip Applying Forceps, Vessel Clips  
 Clip-Anlegepinzette, Gefäßclips  
 Pinzas para aplicar clips  
 Pincas pour poser les clips vasculaires, Clips vasculaires  
 Pinze per applicazione clips vascolari

**Biemer Clip Applying Forcep**  
Without Lock



Catalog #	Size
AF-010-14	14.5 cm (5 3/4")

**Biemer Clip Applying Forcep**  
With Lock



Catalog #	Size
AF-012-14	14.5 cm (5 3/4")

**Biemer Vessel Clip**



Catalog #	Size, Opening, Jaw Length, Closing Pressure
AF-016-14	14 mm, 4 mm, 4 mm, 30 - 40 gr

**Biemer Vessel Clip**



Catalog #	Size, Opening, Jaw Length, Closing Pressure
AF-018-17	17 mm, 7 mm, 5 mm, 30 - 40 gr

**Biemer Vessel Clip**



Catalog #	Size, Opening, Jaw Length, Closing Pressure
AF-020-17	17 mm, 7 mm, 5 mm, 20 - 25 gr



Vessel Clips, Approximators  
Gefäßclips, Approximatoren  
Clips vasculares, Aproximadores  
Clips vasculaires, Approximateurs  
Clip vascolari, Approssimatori

**Biemer-Mueller Approximator**  
Straight, Wide

Catalog #	Size, Opening, Jaw Length, Closing Pressure
AF-024-17	17 mm, 5 mm, 9 mm, 25 - 30 gr

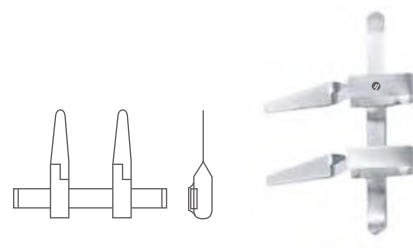

**Biemer-Mueller Approximator**  
Angled, Wide

Catalog #	Size, Opening, Jaw Length, Closing Pressure
AF-025-17	17 mm, 5 mm, 9 mm, , 25 - 30 gr

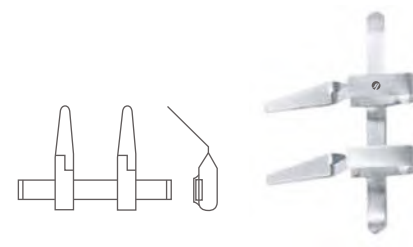

**Biemer-Mueller Approximator**  
Straight, Narrow

Catalog #	Size, Opening, Jaw Length, Closing Pressure
AF-026-13	13 mm, 3 mm, 4.5 mm, 25 - 30 gr
AF-026-17	17 mm, 5 mm, 9 mm, , 25 - 30 gr

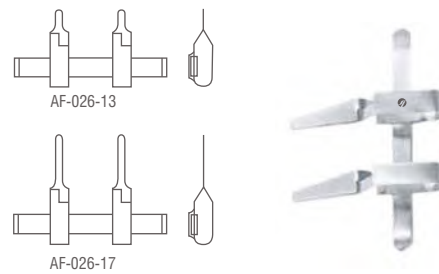

**Biemer-Mueller Approximator**  
Angled, Narrow

Catalog #	Size, Opening, Jaw Length, Closing Pressure
AF-027-17	17 mm, 5 mm, 9 mm. 25 - 30 gr

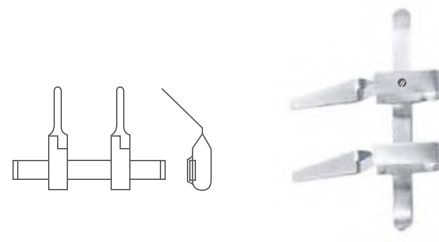





Approximators, Nerve Approximators  
 Approximatoren, Nerv-Approximatoren  
 Aproximadores, Aproximadores para nervios  
 Approximateurs, Approximateurs pour nerfs  
 Approssimatori, Approssimatori per nervi

**Mueller Approximator**

Catalog #	Size, Diameter, Closing Pressure
AF-030-01	17 mm, Ø 1 mm, 25 - 30 gr
AF-030-02	17 mm, Ø 2 mm, 25 - 30 gr
AF-030-03	17 mm, Ø 3 mm, 25 - 30 gr
AF-030-04	17 mm, Ø 4 mm, 25 - 30 gr

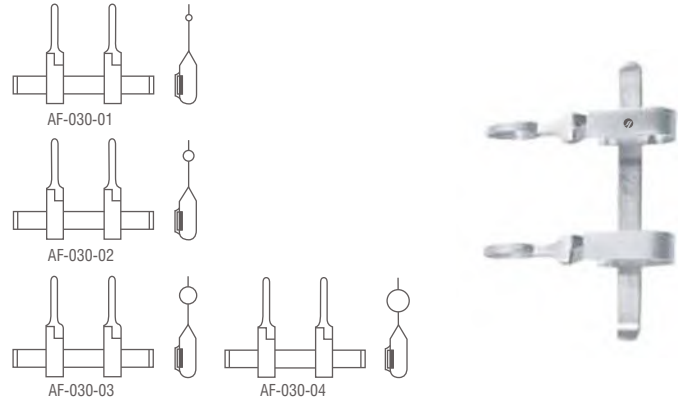

**Nerve Approximator**  
 Complete With Key

Catalog #	Size
AF-040-00	Standard



**Key For Approximator**

Catalog #	Size
AF-040-01	Standard



**Nerve Approximator**  
 Approximator Only

Catalog #	Size
AF-040-02	Standard



**Nerve Approximator- Complete With Key**  
 Needles Exchangeable by Mean of Key

Catalog #	Size
AF-044-00	Standard





Mini Vessel Clips, Clip Applying Forceps  
Mini-Gefäßclips, Clip-Anlegezangen, Bulldogklemmen  
Mini Clips vasculares, Pinzas para aplicar clips  
Micro-clips vasculaires, Pinces pour poser micro-clips  
Mini-clip vascolari, Pinze per applicare clips vascolari

**Nerve Approximator**

Approximator With Needles Only

Catalog #	Size
AF-044-02	Standard



**Nerve Approximator**

Spare Needles Only

Catalog #	Size
AF-044-04	Standard



**Clip Applying Forcep**

With Ratchet

Catalog #	Size
AF-046-14	Standard



**Clip Applying Forcep**

Bayonet Shaped, With Ratchet

Catalog #	Size
AF-049-18	18.5 cm ( 7 1/4")



**Mini Vessel Clip**

Catalog #	Size, Jaw Size, Closing Pressure
AF-050-04	13 mm, 4.0 x 0.75 mm, 60 gr
AF-050-06	15 mm, 6.0 x 1.0 mm, 85 gr
AF-050-08	17 mm, 8.0 x 2.0 mm, 100 gr
AF-050-10	20 mm, 10.0 x 2.0 mm, 125 gr





Bulldog Clamps  
Bulldogklemmen  
Clamps Bulldog  
Clamps Bulldog  
Pinze Bulldog

**Dieffenbach Bulldog Clamp**  
Straight

Catalog #	Size
AF-060-06	6 cm (2 1/4")



**Dieffenbach Bulldog Clamp**  
Curved

Catalog #	Size
AF-061-06	6 cm (2 1/4")



**Dieffenbach Bulldog Clamp**  
Straight

Catalog #	Size
AF-062-03	3.5 cm (1 1/2")
AF-062-05	5 cm (2")



**Dieffenbach Bulldog Clamp**  
Curved

Catalog #	Size
AF-063-03	3.5 cm (1 1/2")
AF-063-05	5 cm (2")





**John-Hopkins Bulldog Clamp**

Catalog #	Size
AF-065-35	3.5 cm (1 1/2")
AF-065-50	5 cm (2")
AF-065-55	5.5 cm (2 1/8")
AF-065-65	6.5 cm (2 1/2")
AF-065-70	7 cm (2 3/4")
AF-065-80	8 cm (3 1/4")
AF-065-90	9 cm (3 1/2")



**John-Hopkins Clip Applying Forcep**

Catalog #	Size
AF-067-24	24 cm (9 1/2")



**Diethrich Bulldog Clamp**  
Straight

Catalog #	Size, Jaw Length
AF-080-45	45 mm, 8 mm
AF-080-50	50 mm, 12 mm
AF-080-60	60 mm, 20 mm



**Diethrich Bulldog Clamp**  
Angled

Catalog #	Size, Jaw Length
AF-081-40	45 mm, 8 mm
AF-081-45	50 mm, 12 mm
AF-081-50	60 mm, 20mm





Bulldog Clamps  
Bulldogklemmen  
Clamps Bulldog  
Clamps Bulldog  
Pinze Bulldog

**DeBakey-Diethrich Atrauma Bulldog Clamp**  
Straight

Catalog #	Size, Jaw Length
AF-084-10	45 mm, 10 mm
AF-084-14	50 mm, 14 mm
AF-084-20	60 mm, 20mm

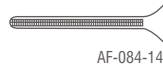

**DeBakey-Diethrich Atrauma Bulldog Clamp**  
Straight, Titanium

Catalog #	Size, Jaw Length
AF-084-10 T	45 mm, 10 mm
AF-084-14 T	50 mm, 14 mm
AF-084-20 T	60 mm, 20mm

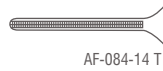

**DeBakey-Diethrich Atrauma Bulldog Clamp**  
Angled

Catalog #	Size, Jaw Length
AF-085-10	35 mm, 10 mm
AF-085-14	45 mm, 14 mm
AF-085-20	50 mm, 20 mm

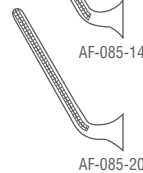
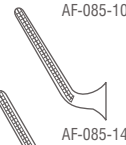

**DeBakey-Diethrich Atrauma Bulldog Clamp**  
Angled, Titanium

Catalog #	Size, Jaw Length
AF-085-10 T	35 mm, 10 mm
AF-085-14 T	45 mm, 14 mm
AF-085-20 T	50 mm, 20mm

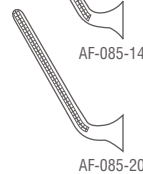
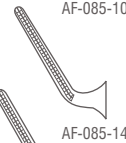
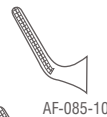



**DeBakey-Hess Bulldog Clamp**

Catalog #	Size, Jaw Length
AF-089-35	35 mm, 10 mm
AF-089-40	40 mm, 10 mm



**Mini-Glover Vena Atrauma Bulldog Clamp**  
Straight, Titanium

Catalog #	Size, Jaw Length
AF-090-30 T	30 mm, 9 mm
AF-090-35 T	35 mm, 13 mm
AF-090-40 T	40 mm, 14 mm
AF-090-50 T	50 mm, 23 mm



**Mini-Glover Vena Atrauma Bulldog Clamp**  
Gently Curved, Titanium

Catalog #	Size, Jaw Length
AF-091-30 T	30 mm, 9 mm
AF-091-35 T	35 mm, 13 mm
AF-091-40 T	40 mm, 14 mm
AF-091-50 T	50 mm, 23 mm



**Mini-Glover Vena Atrauma Bulldog Clamp**  
Strongly Curved, Titanium

Catalog #	Size, Jaw Length
AF-093-30 T	30 mm, 9 mm
AF-093-35 T	35 mm, 13 mm
AF-093-40 T	40 mm, 14 mm
AF-093-50 T	50 mm, 23 mm





Bulldog Clamps, Haemostatic Forceps  
Bulldogklemmen, Arterienklemmen  
Clamps Bulldog, Pinzas hemostáticas  
Clamps Bulldog, Pinces hémostatiques  
Pinze Bulldog, Pinze emostatiche

**Mini-Glover Arteria Atrauma Bulldog Clamp**  
Straight, Titanium

Catalog #	Size, Jaw Length
AF-096-30 T	30 mm, 9 mm
AF-096-35 T	35 mm, 13 mm
AF-096-40 T	40 mm, 14 mm
AF-096-50 T	50 mm, 23 mm



**Mini-Glover Arteria Atrauma Bulldog Clamp**  
Gently Curved, Titanium

Catalog #	Size, Jaw Length
AF-097-30 T	30 mm, 9 mm
AF-097-35 T	35 mm, 13 mm
AF-097-40 T	40 mm, 14 mm
AF-097-50 T	50 mm, 22 mm



**Mini-Glover Arteria Atrauma Bulldog Clamp**  
Strongly Curved, Titanium

Catalog #	Size, Jaw Length
AF-099-30 T	30 mm, 10mm
AF-099-35 T	35 mm, 14 mm
AF-099-40 T	40 mm, 15 mm
AF-099-50 T	50 mm, 21mm



**Pean Haemostatic Forcep**

Catalog #	Size
AF-110-14	14.5 cm (5 3/4")
AF-110-16	16 cm (6 1/4")







Haemostatic Forceps  
Arterienklemmen  
Pinzas hemostáticas  
Pinces hémostatiques  
Pinze emostatiche

**Korenlein Haemostatic Forcep**

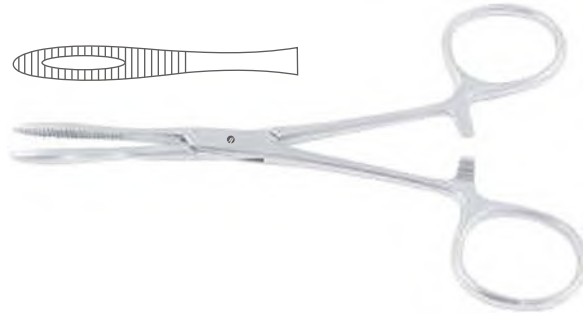

Catalog #	Size
AF-112-13	13 cm (5")

**Spencer-Wells Haemostatic Forcep**  
Straight



Catalog #	Size
AF-114-13	13 cm (5")
AF-114-14	14.5 cm (5 3/4")
AF-114-15	15.5 cm (6")
AF-114-18	18.5 cm (7 1/4")
AF-114-20	20 cm (8")

**Spencer-Wells Haemostatic Forcep**  
Curved



Catalog #	Size
AF-115-13	13 cm (5")
AF-115-14	14 cm (5 3/4")
AF-115-15	15 cm (6")
AF-115-18	18 cm (7 1/4")
AF-115-20	20 cm (8")

**Chaput Haemostatic Forcep**  
2 x 3 Teeth



Catalog #	Size
AF-120-13	12.5 cm (5")



Haemostatic Forceps, Organ Grasping Forceps  
Arterienklemmen, Organfasszangen  
Pinzas hemostáticas, Pinzas para sacar órganos  
Pinces hémostatiques, Pinces pour saisir organes  
Pinze emostatiche, Pinze per afferrare organi

**Tuffier Haemostatic Forcep**

4 x 5 Teeth

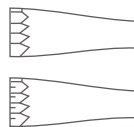

Catalog #	Size
AF-122-13	12.5 cm (5")

**Atrauma Organ Grasping / Haemorrhoidal Forcep**

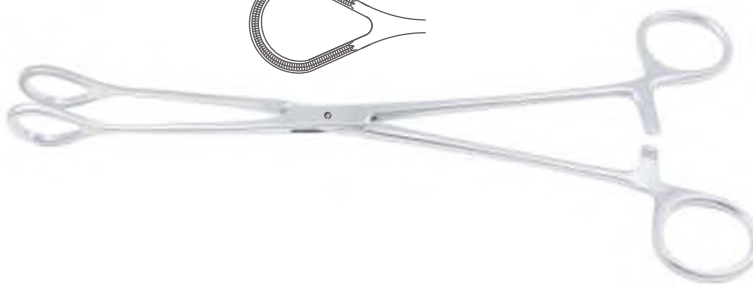
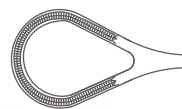

Catalog #	Size
AF-126-25	25 cm (9 3/4")
AF-126-26	26 cm (10 1/4")

**Collin Organ Grasping Forcep**

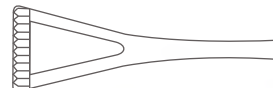

Catalog #	Size
AF-128-14	14 cm (5 1/2")

**Collin Tumor Grasping Forcep**

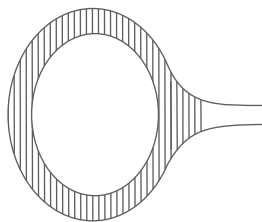

Catalog #	Size
AF-130-17	17 cm (6 3/4")

**Pennington Organ Grasping Forcep**

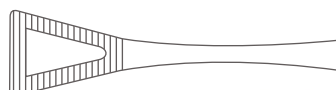

Catalog #	Size
AF-134-15	15.5 cm (6")
AF-134-20	21 cm (8 1/4")



Haemostatic Forceps  
Arterienklemmen  
Pinzas hemostáticas  
Pinces hémostatiques  
Pinze emostatiche

AF

ARTERY FORCEP

**Pratt Haemostatic Forcep**

Catalog #	Size
AF-136-15	15 cm (6")

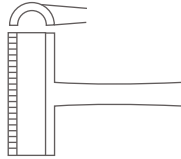

**Martel-Rees Face-Lift Forcep**

Catalog #	Size
AF-138-14	13.5 cm (5 1/4")

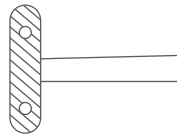

**Hartmann Haemostatic Forcep  
Straight**

Catalog #	Size
AF-140-10	10 cm (4")



**Hartmann Haemostatic Forcep  
Curved**

Catalog #	Size
AF-141-10	9.5 cm (3 3/4")



**Hartmann Haemostatic Forcep  
Straight, 1 x 2 Teeth**

Catalog #	Size
AF-142-10	10 cm (4")





Haemostatic Forceps  
Arterienklemmen  
Pinzas hemostáticas  
Pinces hémostatiques  
Pinze emostatiche

**Hartmann Haemostatic Forcep**  
Curved, 1 x 2 Teeth



Catalog #	Size
AF-143-10	9.5 cm (3 3/4")

**Haemostatic Forcep**  
Cross Serrated Jaw



Catalog #	Size
AF-146-12	12.5 cm (5")

**Carrel Haemostatic Forcep**



Catalog #	Size
AF-148-08	8.5 cm (3 1/4")

**Terrier Haemostatic Forcep**  
1 x 2 Teeth



Catalog #	Size
AF-150-08	8.5 cm (3 1/4")

**Halsted-Mosquito Haemostatic Forcep**  
Straight



Catalog #	Size
AF-160-12	12.5 cm (4 3/4")
AF-160-14	14.5 cm (5 1/2")



Haemostatic Forceps  
Arterienklemmen  
Pinzas hemostáticas  
Pincas hémostatiques  
Pinze emostatiche

**Halsted-Mosquito Haemostatic Forcep**  
Curved



Catalog #	Size
AF-161-12	12 cm (4 3/4")
AF-161-14	14 cm (5 1/2")

**Halsted-Mosquito Haemostatic Forcep**  
Straight, 1 x 2 Teeth



Catalog #	Size
AF-162-12	12.5 cm (4 3/4")
AF-162-14	14.5 cm (5 3/4")

**Halsted-Mosquito Haemostatic Forcep**  
Curved, 1 x 2 Teeth



Catalog #	Size
AF-163-12	12 cm (4 3/4")
AF-163-14	14 cm (5 1/2")

**Micro-Mosquito Haemostatic Forcep**  
Straight



Catalog #	Size
AF-170-10	10 cm (4")
AF-170-12	12 cm (4 3/4")



Haemostatic Forceps  
Arterienklemmen  
Pinzas hemostáticas  
Pinces hémostatiques  
Pinze emostatiche

**Micro-Mosquito Haemostatic Forcep  
Curved**

Catalog #	Size
AF-171-10	9.5 cm (3 ¾")
AF-171-12	11.5 cm (4 ½")



**Micro-Mosquito Haemostatic Forcep  
Straight, 1 x 2 Teeth**

Catalog #	Size
AF-172-10	10 cm (4")
AF-172-12	12 cm (4 ¾")



**Micro-Mosquito Haemostatic Forcep  
Curved, 1 x 2 Teeth**

Catalog #	Size
AF-173-10	10 cm (4")
AF-173-12	12 cm (4 ¾")



**Halsted-Mosquito Haemostatic Forcep  
Straight**

Catalog #	Size
AF-176-18	18.5 cm (7 ¼")
AF-176-21	21 cm (8 ¼")





Haemostatic Forceps  
Arterienklemmen  
Pinzas hemostáticas  
Pinces hémostatiques  
Pinze emostatiche

**Halsted-Mosquito Haemostatic Forcep**  
Curved



Catalog #	Size
AF-177-18	18 cm (7")
AF-177-21	20.5 cm (8")

**Halsted-Mosquito Haemostatic Forcep**  
Straight, 1 x 2 Teeth



Catalog #	Size
AF-178-18	18.5 cm (7 1/4")
AF-178-21	21 cm (8 1/4")

**Halsted-Mosquito Haemostatic Forcep**  
Curved, 1 x 2 Teeth

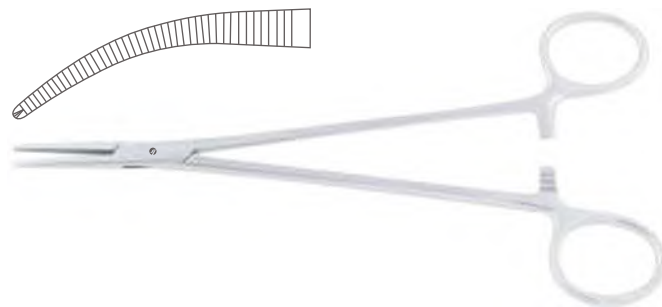

Catalog #	Size
AF-179-18	18 cm (7")
AF-179-21	21 cm (8")

**Providence-Hospital Haemostatic Forcep**  
Straight



Catalog #	Size
AF-182-14	14 cm (5 1/2")

**Providence-Hospital Haemostatic Forcep**  
Curved



Catalog #	Size
AF-183-14	14 cm (5 1/2")



Haemostatic Forceps  
Arterienklemmen  
Pinzas hemostáticas  
Pinces hémostatiques  
Pinze emostatiche

**Leriche Haemostatic Forcep**  
Straight

Catalog #	Size
AF-184-15	15.5 cm (6")

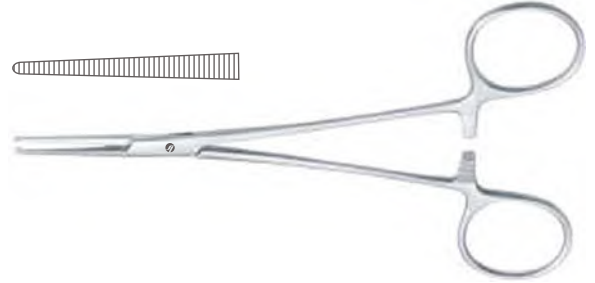

**Leriche Haemostatic Forcep**  
Curved

Catalog #	Size
AF-185-15	15 cm (6")



**Leriche Haemostatic Forcep**  
Straight, 1 x 2 Teeth

Catalog #	Size
AF-186-15	15.5 cm (6")

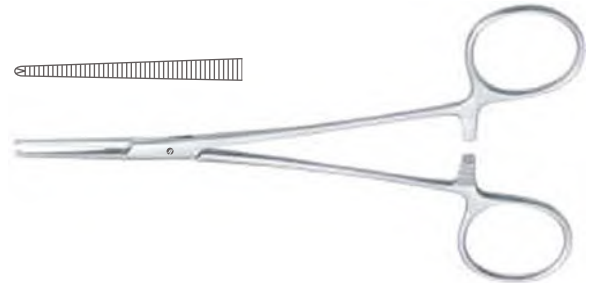

**Leriche Haemostatic Forcep**  
Curved, 1 x 2 Teeth

Catalog #	Size
AF-187-15	15 cm (6")



**Kelly Haemostatic Forcep**  
Straight

Catalog #	Size
AF-200-14	14.5 cm (5 3/4")







Haemostatic Forceps  
Arterienklemmen  
Pinzas hemostáticas  
Pinces hémostatiques  
Pinze emostatiche

**Kelly Haemostatic Forcep**  
Curved



Catalog #	Size
AF-201-14	14 cm (5 1/2")

**Kelly-Rankin Haemostatic Forcep**  
Straight

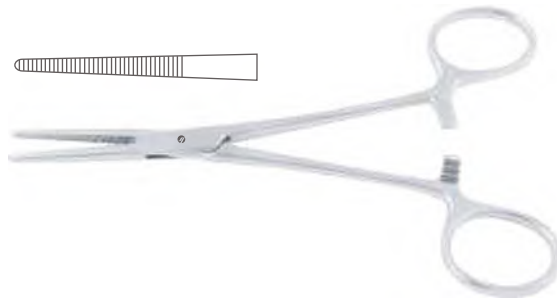

Catalog #	Size
AF-202-16	16 cm (6 1/4")

**Kelly-Rankin Haemostatic Forcep**  
Curved



Catalog #	Size
AF-203-16	15.5 cm (6")

**Crile Haemostatic Forcep**  
Straight



Catalog #	Size
AF-210-14	14.5 cm (5 3/4")

**Crile Haemostatic Forcep**  
Curved



Catalog #	Size
AF-211-14	14 cm (5 1/2")



Haemostatic Forceps  
Arterienklemmen  
Pinzas hemostáticas  
Pinces hémostatiques  
Pinze emostatiche

**Crile Haemostatic Forcep**  
Straight, 1 x 2 Teeth



Catalog #	Size
AF-212-14	14 cm (5 1/2")

**Crile Haemostatic Forcep**  
Curved, 1 x 2 Teeth



Catalog #	Size
AF-213-14	14 cm (5 1/2")

**Crile-Rankin Haemostatic Forcep**  
Straight

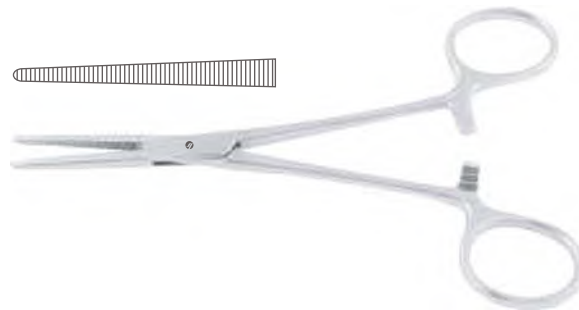

Catalog #	Size
AF-214-16	17 cm (6 3/4")

**Crile-Rankin Haemostatic Forcep**  
Curved



Catalog #	Size
AF-215-16	17 cm (6 3/4")



Haemostatic Forceps  
Arterienklemmen  
Pinzas hemostáticas  
Pinces hémostatiques  
Pinze emostatiche

AF

ARTERY FORCEP

**Rochester-Pean Haemostatic Forcep**  
Straight

Catalog #	Size
AF-220-14	14.5 cm (5 3/4")
AF-220-16	16.5 cm (6 1/2")
AF-220-18	18.5 cm (7 1/4")
AF-220-20	20.5 cm (8")
AF-220-22	22.5 cm (8 3/4")
AF-220-24	24.5 cm (9 3/4")
AF-220-26	26 cm (10 1/4")
AF-220-30	30.5 cm (12")

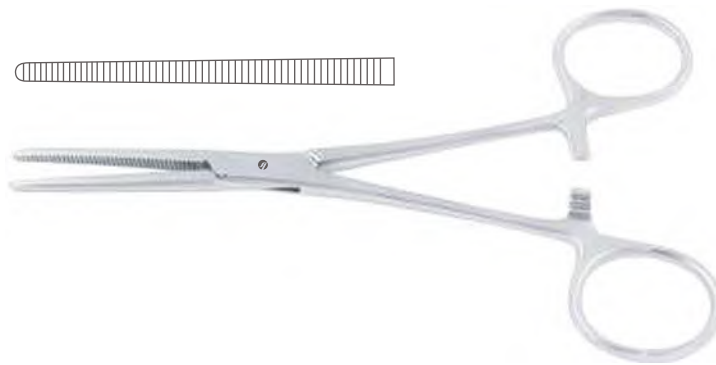

**Rochester-Pean Haemostatic Forcep**  
Curved

Catalog #	Size
AF-221-14	14 cm (5 1/2")
AF-221-16	16 cm (6 1/4")
AF-221-18	18 cm (7")
AF-221-20	20 cm (8")
AF-221-22	22 cm (8 3/4")
AF-221-24	24 cm (9 1/2")
AF-221-26	25.5 cm (10")
AF-221-30	30 cm (11 3/4")

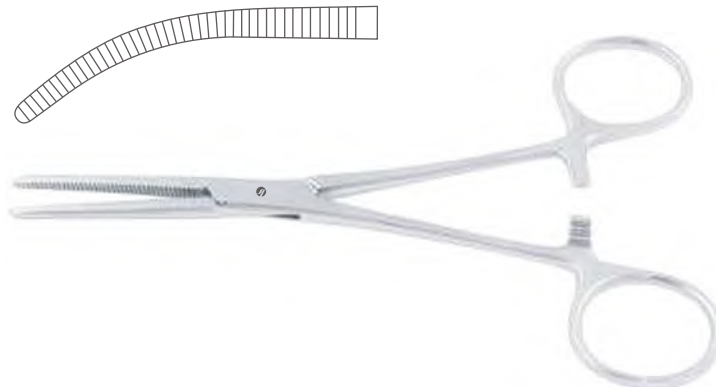

**Ochsner-Kocher Haemostatic Forcep**  
Straight, 1 x 2 Teeth

Catalog #	Size
AF-230-14	14.5 cm (5 3/4")
AF-230-16	16.5 cm (6 1/2")
AF-230-18	18.5 cm (7 1/4")
AF-230-20	20.5 cm (8")
AF-230-22	22.5 cm (8 3/4")
AF-230-24	24.5 cm (9 3/4")
AF-230-26	26 cm (10 1/4")
AF-230-30	30.5 cm (12")

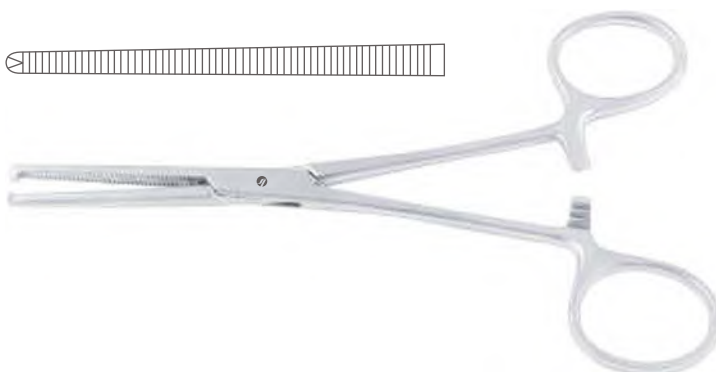



Haemostatic Forceps  
Arterienklemmen  
Pinzas hemostáticas  
Pinces hémostatiques  
Pinze emostatiche

**Ochsner-Kocher Haemostatic Forcep**  
Curved, 1 x 2 Teeth

Catalog #	Size
AF-231-14	14 cm (5 1/2")
AF-231-16	16 cm (6 1/4")
AF-231-18	18 cm (7")
AF-231-20	20 cm (8")
AF-231-22	22 cm (8 3/4")
AF-231-24	24 cm (9 1/2")
AF-231-26	25.5 cm (10 ")
AF-231-30	30 cm (11 3/4")

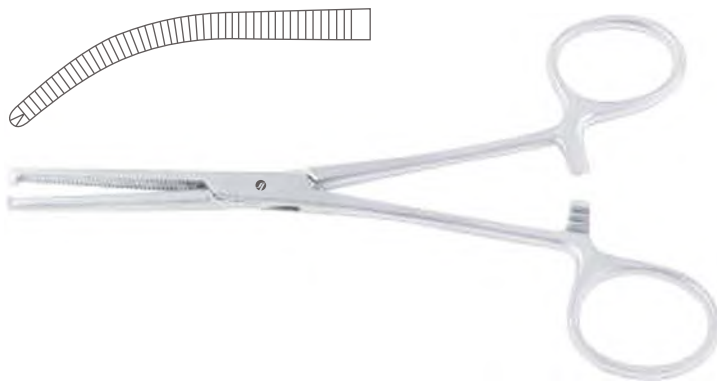

**Rochester-Ochsner Haemostatic Forcep**  
Straight

Catalog #	Size
AF-234-14	14 cm (5 1/2")



**Rochester-Ochsner Haemostatic Forcep**  
Curved

Catalog #	Size
AF-235-14	14 cm (5 1/2")



**Kocher Haemostatic Forcep**  
Straight, 1 x 2 Teeth

Catalog #	Size
AF-236-15	15 cm (6")





Haemostatic Forceps  
Arterienklemmen  
Pinzas hemostáticas  
Pinces hémostatiques  
Pinze emostatiche

**Kocher Haemostatic Forcep**  
Curved, 1 x 2 Teeth

Catalog #	Size
AF-237-15	15 cm (6")



**Pean-Nippon Haemostatic Forcep**  
Straight

Catalog #	Size
AF-240-14	14.5 cm (5 3/4")
AF-240-16	16.5 cm (6 1/2")
AF-240-18	18.5 cm (7 1/4")



**Pean-Nippon Haemostatic Forcep**  
Curved

Catalog #	Size
AF-241-14	14 cm (5 1/2")
AF-241-16	16 cm (6 1/4")
AF-241-18	18 cm (7")



**Kocher-Nippon Haemostatic Forcep**  
Straight, 1 x 2 Teeth

Catalog #	Size
AF-242-14	14.5 cm (5 3/4")
AF-242-16	16.5 cm (6 1/2")
AF-242-18	18.5 cm (7 1/4")





Haemostatic Forceps  
Arterienklemmen  
Pinzas hemostáticas  
Pinces hémostatiques  
Pinze emostatiche

**Kocher-Nippon Haemostatic Forcep**  
Curved, 1 x 2 Teeth



Catalog #	Size
AF-243-14	14.5 cm (5 ¾")
AF-243-16	16 cm (6 ¼")
AF-243-18	18 cm (7")

**Pean (Delicate) Haemostatic Forcep**  
Straight



Catalog #	Size
AF-246-13	13.5 cm (5 ¼")
AF-246-14	14.5 cm (5 ¾")
AF-246-16	17 cm (6 ¾")

**Pean (Delicate) Haemostatic Forcep**  
Curved



Catalog #	Size
AF-247-13	13 cm (5")
AF-247-14	14 cm (5 ½")
AF-247-16	16.5 cm (6 ½")

**Kocher (Delicate) Haemostatic Forcep**  
Straight, 1 x 2 Teeth



Catalog #	Size
AF-248-13	13 cm (5")
AF-248-14	14 cm (5 ½")
AF-248-17	16 cm (6 ¼")



Haemostatic Forceps  
Arterienklemmen  
Pinzas hemostáticas  
Pincas hémostatiques  
Pinze emostatiche

**Kocher (Delicate) Haemostatic Forcep**  
Curved, 1 x 2 Teeth



Catalog #	Size
AF-249-13	13 cm (5")
AF-249-14	14 cm (5 ½")
AF-249-16	16 cm (6 ¼")

**Coller Haemostatic Forcep**  
Straight

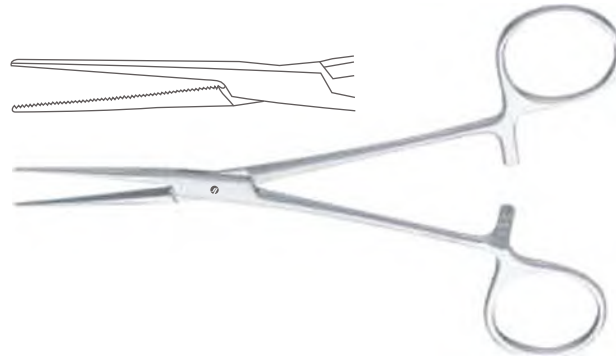

Catalog #	Size
AF-260-14	14 cm (5 ½")
AF-260-16	16.5 cm (6 ½")
AF-260-18	18.5 cm (7 ¼")

**Coller Haemostatic Forcep**  
Curved

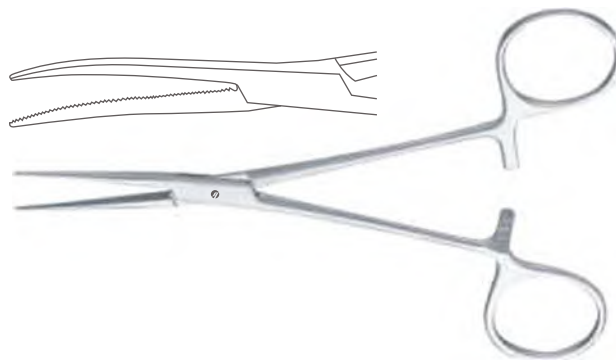

Catalog #	Size
AF-261-14	14 cm (5 ½")
AF-261-16	16.5 cm (6 ½")
AF-261-18	18.5 cm (7 ¼")

**Fraser-Kelly (Crile) Haemostatic Forcep**  
Curved

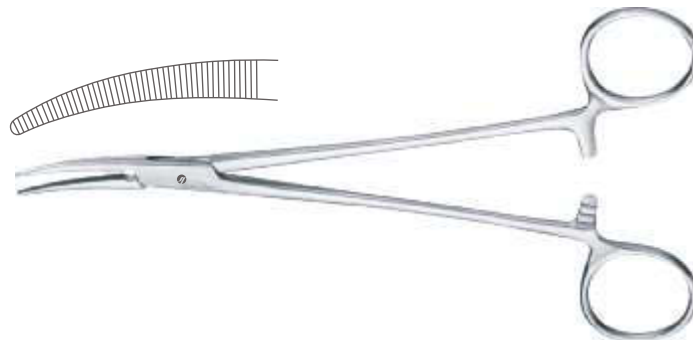

Catalog #	Size
AF-265-18	18 cm (7")



Haemostatic Forceps  
Arterienklemmen  
Pinzas hemostáticas  
Pinces hémostatiques  
Pinze emostatiche

**Adson Haemostatic Forcep**  
Straight

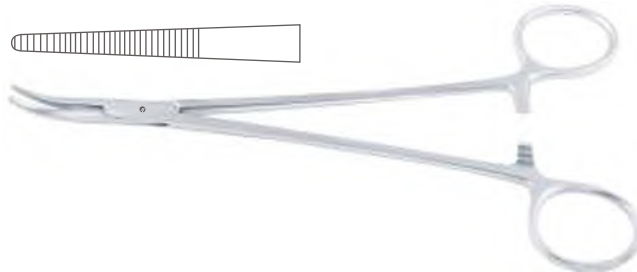

Catalog #	Size
AF-268-18	19 cm (7 1/2")

**Adson Haemostatic Forcep**  
Curved



Catalog #	Size
AF-269-18	18.5 cm (7 1/4")

**Adson Haemostatic Forcep**  
Curved

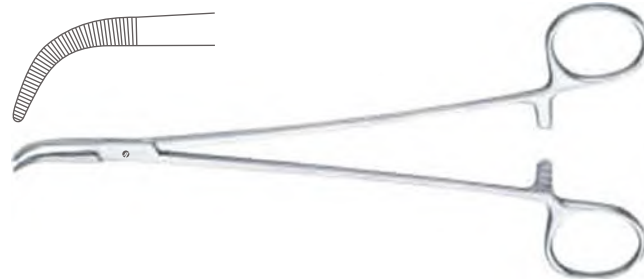

Catalog #	Size
AF-271-21	21.5 cm (8 1/2")

**Jacobson Haemostatic Forcep**  
Curved

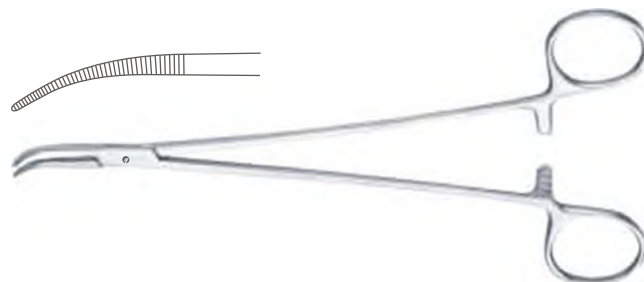

Catalog #	Size
AF-275-19	19 cm (7 1/2")

**Dunhill Haemostatic Forcep**  
Gently Curved



Catalog #	Size
AF-277-19	19 cm (7 1/2")





Haemostatic Forceps  
Arterienklemmen  
Pinzas hemostáticas  
Pinces hémostatiques  
Pinze emostatiche

**Grey-Turner Haemostatic Forcep**  
Curved

Catalog #	Size
AF-279-19	18 cm (7")

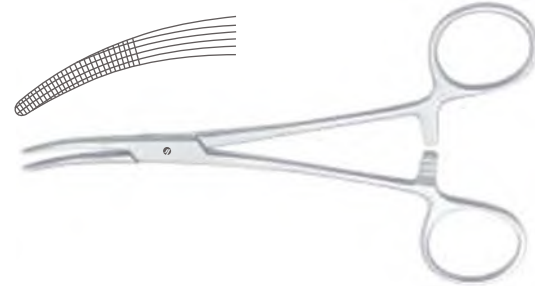

**Dandy-Mosquito Haemostatic Forcep**  
Laterally Curved, Cross Serrated

Catalog #	Size
AF-281-12	12 cm (4 3/4")

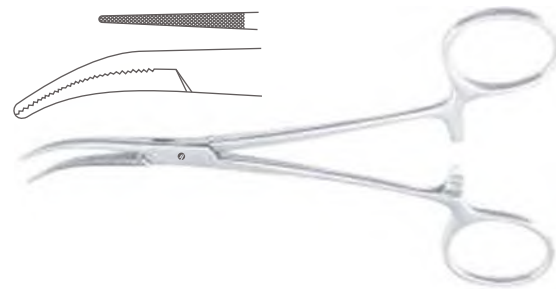

**Dandy Haemostatic Forcep**  
Laterally Curved

Catalog #	Size
AF-283-14	14.5 cm (5 3/4")

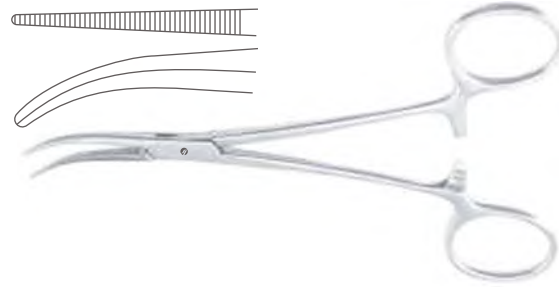

**Dandy Haemostatic Forcep**  
Laterally Curved, 1 x 2 Teeth

Catalog #	Size
AF-285-14	14.5 cm (5 3/4")

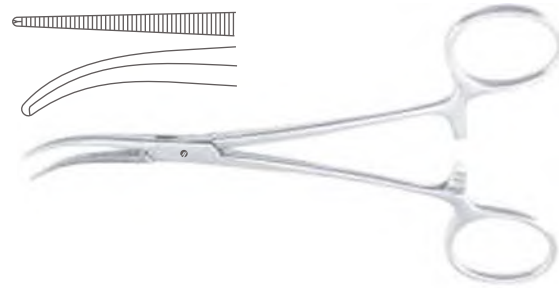

**Cairns Haemostatic Forcep**  
Straight

Catalog #	Size
AF-290-15	15 cm (6")

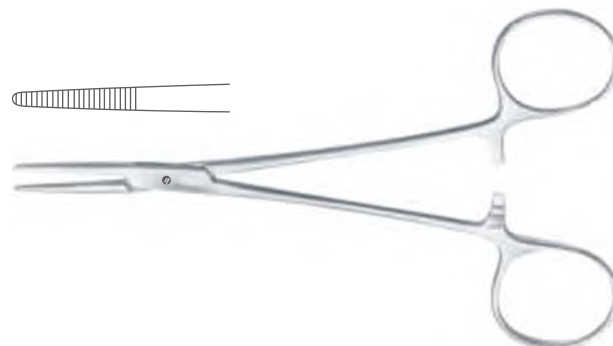



Haemostatic Forceps  
Arterienklemmen  
Pinzas hemostáticas  
Pinces hémostatiques  
Pinze emostatiche

**Cairns Haemostatic Forcep**  
Curved

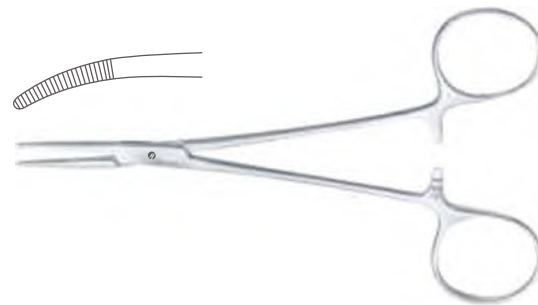

Catalog #	Size
AF-291-15	15 cm (6")

**Cairns Haemostatic Forcep**  
Curved to Side

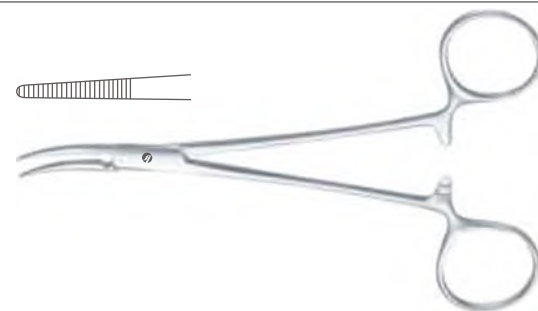

Catalog #	Size
AF-293-14	14.5 cm (5 3/4")

**Dunhill Haemostatic Forcep**  
Straight



Catalog #	Size
AF-295-13	13 cm (5")

**Lovlace Haemostatic Forcep**  
Straight, Cross Serrated



Catalog #	Size
AF-300-16	16 cm (6 1/4")

**Lovlace Haemostatic Forcep**  
Straight, Cross Serrated, 1 x 2 Teeth



Catalog #	Size
AF-302-16	16 cm (6 1/4")



Haemostatic Forceps  
Arterienklemmen  
Pinzas hemostáticas  
Pinces hémostatiques  
Pinze emostatiche

**Martin-Fuchsig Haemostatic Forcep**  
Curved

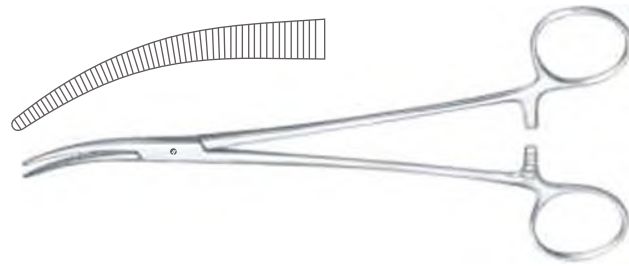

Catalog #	Size
AF-305-20	20.5 cm (8")

**Nissen Haemostatic Forcep**  
Curved

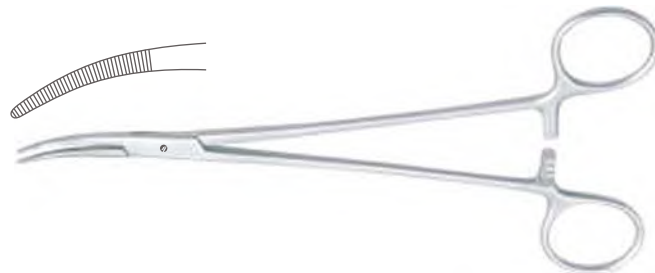

Catalog #	Size
AF-307-18	18.5 cm (7 1/4")

**Schmidt Tonsil Haemostatic Forcep**  
Strongly Curved



Catalog #	Size
AF-311-01	18.5 cm (7 1/4")

**Schmidt Tonsil Haemostatic Forcep**  
Gently Curved

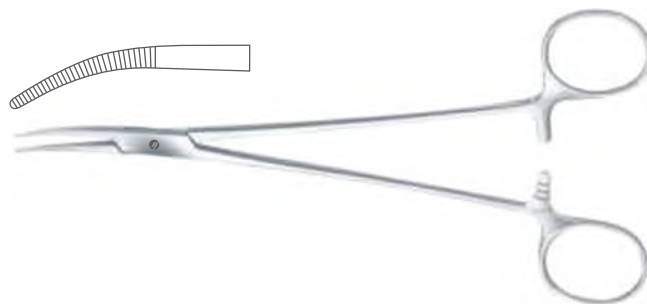

Catalog #	Size
AF-311-02	19 cm (7 1/2")

**Negus Haemostatic Forcep**  
Fig. 1



Catalog #	Size
AF-315-01	19.5 cm (7 3/4")



Haemostatic Forceps  
Arterienklemmen  
Pinzas hemostáticas  
Pinces hémostatiques  
Pinze emostatiche

**Negus Haemostatic Forcep**  
Fig. 2



Catalog #	Size
AF-315-02	20 cm (8")

**Wilson Haemostatic Forcep**  
Curved

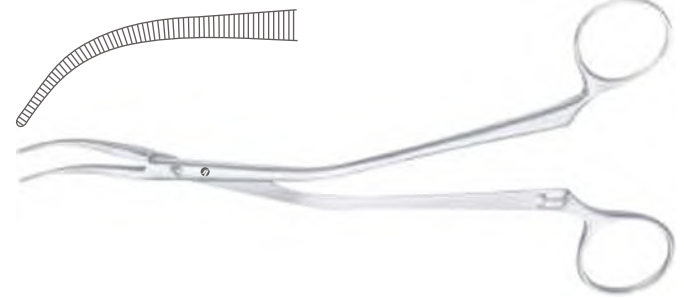

Catalog #	Size
AF-317-19	19 cm (7 1/2")

**Rochester-Carmalt Haemostatic Forcep**  
Straight



Catalog #	Size
AF-320-16	17 cm (6 3/4")
AF-320-20	20.5 cm (8")

**Rochester-Carmalt Haemostatic Forcep**  
Curved

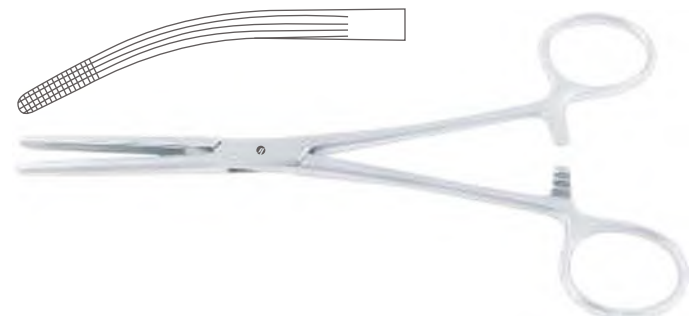

Catalog #	Size
AF-321-16	16.5 cm (6 1/2")
AF-321-20	20 cm (8")

**Fickling Haemostatic Forcep**

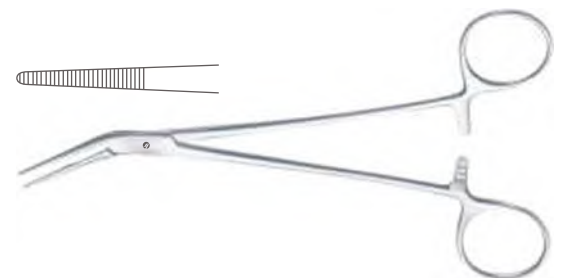

Catalog #	Size
AF-331-18	18 cm (7")



Haemostatic Forceps  
Arterienklemmen  
Pinzas hemostáticas  
Pinces hémostatiques  
Pinze emostatiche

**Fickling Haemostatic Forcep**  
1 x 2 Teeth

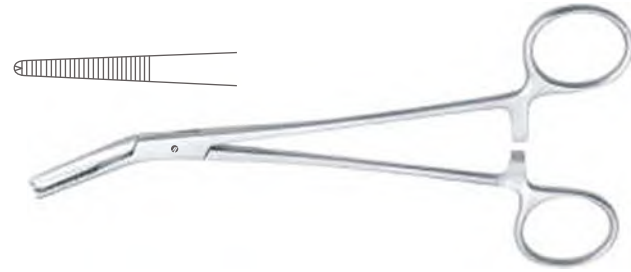

Catalog #	Size
AF-333-18	18 cm (7")

**Bainbridge Haemostatic Forcep**  
Straight, Longitudinally Serrated



Catalog #	Size
AF-340-15	15 cm (6")
AF-340-18	18.5 cm (7 1/4")

**Bainbridge Haemostatic Forcep**  
Curved, Longitudinally Serrated



Catalog #	Size
AF-341-15	15 cm (6")
AF-341-18	18.5 cm (7 1/4")

**Birkett Haemostatic Forcep**  
Straight



Catalog #	Size
AF-346-18	18.5 cm (7 1/4")

**Birkett Haemostatic Forcep**  
Curved



Catalog #	Size
AF-347-18	18.5 cm (7 1/4")



Haemostatic Forceps  
Arterienklemmen  
Pinzas hemostáticas  
Pinces hémostatiques  
Pinze emostatiche

**Bengolea Haemostatic Forcep**  
Straight



Catalog #	Size
AF-350-20	21.5 cm (8 1/2")
AF-350-26	26 cm (10 1/4")

**Bengolea Haemostatic Forcep**  
Curved

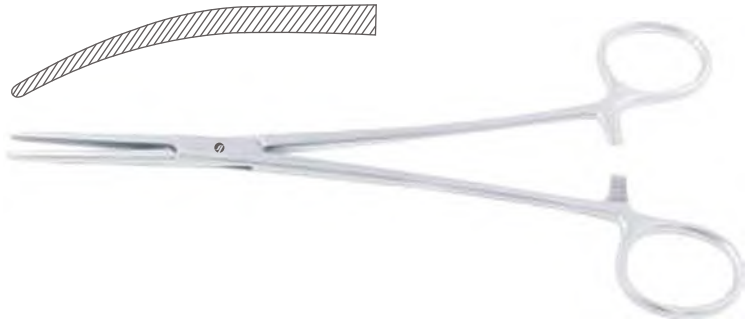

Catalog #	Size
AF-351-20	21 cm (8 1/4")
AF-351-26	25.5 cm (10")

**Bengolea Haemostatic Forcep**  
Straight, 1 x 2 Teeth



Catalog #	Size
AF-352-20	21.5 cm (8 1/2")
AF-352-26	26 cm (10 1/4")

**Bengolea Haemostatic Forcep**  
Curved, 1 x 2 Teeth



Catalog #	Size
AF-353-20	21 cm (8 1/4")
AF-353-26	25.5 cm (10")

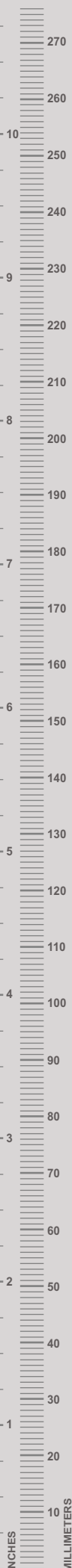



Haemostatic Forceps  
Arterienklemmen  
Pinzas hemostáticas  
Pinces hémostatiques  
Pinze emostatiche

**Roberts Haemostatic Forcep**  
Straight



Catalog #	Size
AF-360-22	22.5 cm (8 ¾")

**Roberts Haemostatic Forcep**  
Curved



Catalog #	Size
AF-361-22	21.5 cm (8 ½")

**Sarot Haemostatic Forcep**  
Straight



Catalog #	Size
AF-364-24	25 cm (9 ¾")

**Sarot Haemostatic Forcep**  
Curved



Catalog #	Size
AF-365-24	24.5 cm (9 ¾")

**Crafoord Haemostatic Forcep**  
Curved

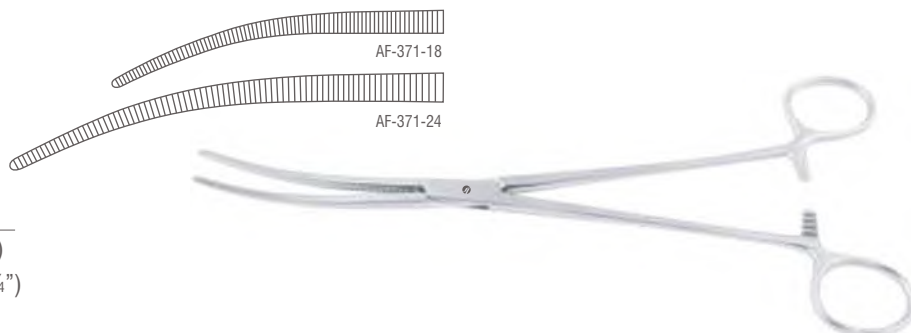

Catalog #	Size
AF-371-18	18 cm (9 ¾")
AF-371-24	24.5 cm (9 ¾")





Haemostatic Forceps  
Arterienklemmen  
Pinzas hemostáticas  
Pinces hémostatiques  
Pinze emostatiche

**Crafoord- Sellors Haemostatic Forcep**

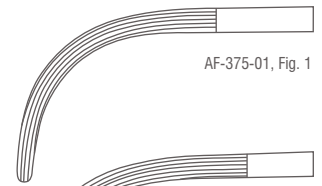

AF-375-01, Fig. 1



AF-375-02, Fig. 2



AF-375-03, Fig. 3

Catalog #	Size, Profile
AF-375-01	24 cm (9 1/2"), Fig. 1
AF-375-02	24 cm (9 1/2"), Fig. 2
AF-375-03	24 cm (9 1/2"), Fig. 3

**Bridge Haemostatic Forcep**  
Straight



Catalog #	Size
AF-380-27	27.5 cm (10 3/4")

**Bridge Haemostatic Forcep**  
Curved

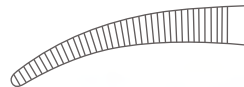

Catalog #	Size
AF-381-27	27.5 cm (10 3/4")





Dissecting and Ligature Forceps  
Präparierklemmen  
Pinzas para preparación y ligadura  
Pinces à disséquer et à ligatures  
Pinze per preparazioni e legature

**Heiss Haemostatic Forcep**



AF-386-20, Straight

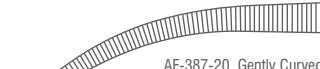

AF-387-20, Gently Curved

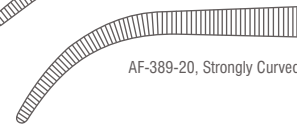

AF-389-20, Strongly Curved

Catalog #	Size, Profile
AF-386-20	21 cm (8 1/4"), Straight
AF-387-20	20.5 cm (8"), Gently Curved
AF-389-20	20 cm (8"), Strongly Curved

**Heiss Haemostatic Forcep**  
Straight, 1 x 2 Teeth

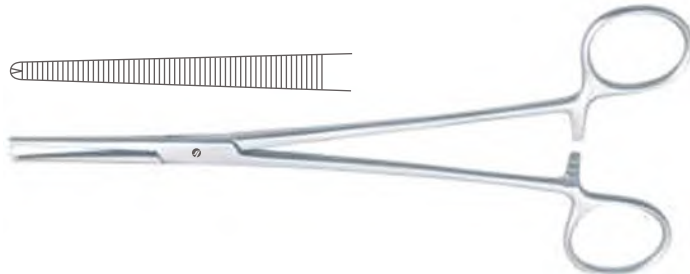

Catalog #	Size
AF-390-20	20 cm (8")

**Heiss Haemostatic Forcep**  
Curved, 1 x 2 Teeth

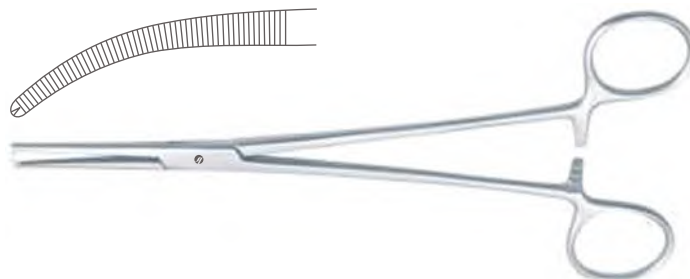

Catalog #	Size
AF-391-20	20 cm (8")



Dissecting and Ligature Forceps  
 Präparierklemmen  
 Pinzas para preparación y ligadura  
 Pinces à disséquer et à ligatures  
 Pinze per preparazioni e legature

**Overholt-Martin Dissecting and Ligature Forcep**

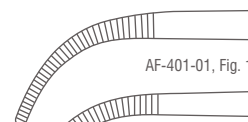

AF-401-01, Fig. 1

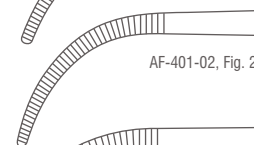

AF-401-02, Fig. 2

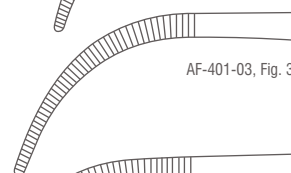

AF-401-03, Fig. 3

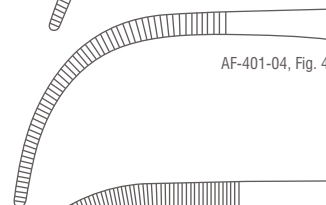

AF-401-04, Fig. 4

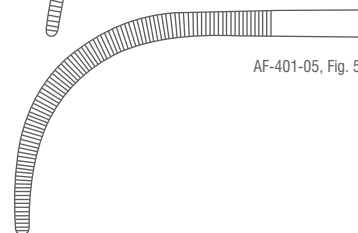

AF-401-05, Fig. 5

Catalog #	Size
AF-401-01	18.5 cm (7 1/4"), Fig. 1
AF-401-02	20.5 cm (8"), Fig. 2
AF-401-03	21 cm (8 1/4"), Fig. 3
AF-401-04	21.5 cm (8 1/2"), Fig. 4
AF-401-05	24.5 cm (9 3/4"), Fig. 5

**Dissecting and Ligature Forcep**  
 Smooth Jaws



Catalog #	Size
AF-404-12	12.5 cm (5")



Dissecting and Ligature Forceps  
Präparierklemmen  
Pinzas para preparación y ligadura  
Pinces à disséquer et à ligatures  
Pinze per preparazioni e legature

**Adson-Baby Dissecting and Ligature Forcep**  
Curved

Catalog #	Size
AF-411-14	14.5 cm (5 ¾")
AF-411-18	18 cm (7")

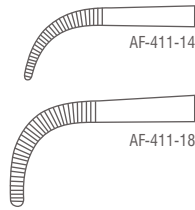

**Overholt-Baby Dissecting and Ligature Forcep**  
Curved

Catalog #	Size
AF-415-14	14 cm (5 ½")

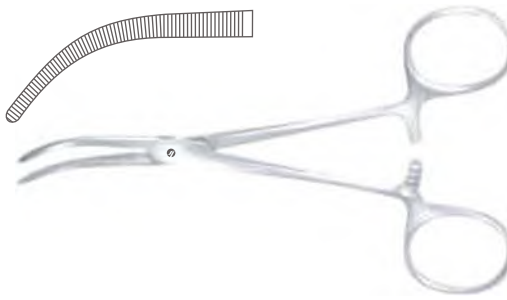
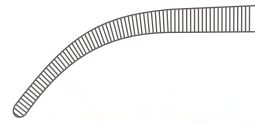

**Overholt-Mixter Dissecting and Ligature Forcep**  
Curved

Catalog #	Size
AF-417-21	21.5 cm (8 ½")

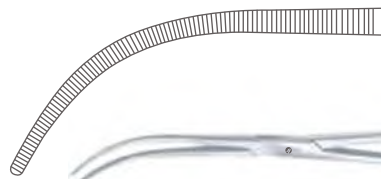



Dissecting and Ligature Forceps  
 Präparierklemmen  
 Pinzas para preparación y ligadura  
 Pinces à disséquer et à ligatures  
 Pinze per preparazioni e legature

**Overholt-Geissendoerfer Dissecting and Ligature Forcep**



Catalog #	Size
AF-421-01	20.5 cm (8"), Fig. 1
AF-421-02	20 cm (8"), Fig. 2
AF-421-03	21.5 cm (8 1/2"), Fig. 3
AF-421-04	22 cm (8 3/4"), Fig. 4
AF-421-05	21.5 cm (8 1/2"), Fig. 5
AF-421-06	22 cm (8 3/4"), Fig. 6
AF-421-07	22 cm (8 3/4"), Fig. 7

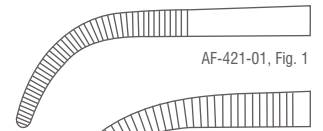

AF-421-01, Fig. 1

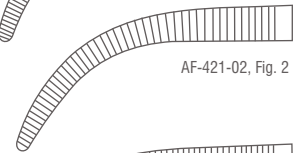

AF-421-02, Fig. 2

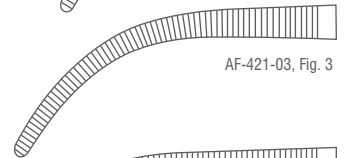

AF-421-03, Fig. 3

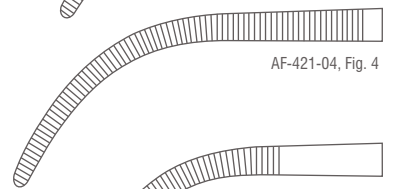

AF-421-04, Fig. 4

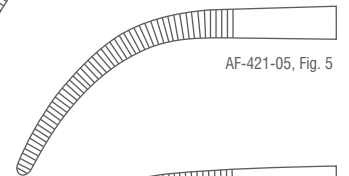

AF-421-05, Fig. 5

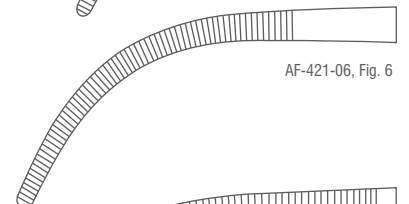

AF-421-06, Fig. 6

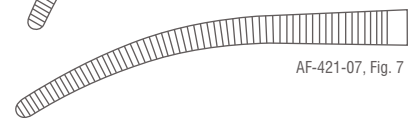

AF-421-07, Fig. 7



Dissecting and Ligature Forceps  
Präparierklemmen  
Pinzas para preparación y ligadura  
Pincas à disséquer et à ligatures  
Pinze per preparazioni e legature

**Overholt-Geissendoerfer Dissecting and Ligature Forcep**



Catalog #	Size
AF-423-01	27 cm (10 3/4"), Fig. 1
AF-423-02	26.5 cm (10 1/2"), Fig. 2
AF-423-03	27.5 cm (10 3/4"), Fig. 3
AF-423-04	28 cm (11"), Fig. 4
AF-423-05	27.5 cm (10 3/4"), Fig. 5
AF-423-06	28 cm (11"), Fig. 6
AF-423-07	27.5 cm (10 3/4"), Fig. 7

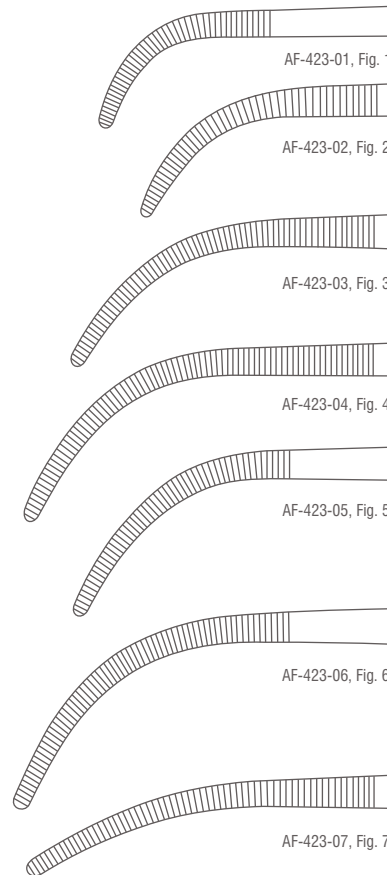



Dissecting and Ligature Forceps  
 Präparierklemmen  
 Pinzas para preparación y ligadura  
 Pincas à disséquer et à ligatures  
 Pinze per preparazioni e legature

**Overholt-Fine Dissecting and Ligature Forcep**  
 Curved

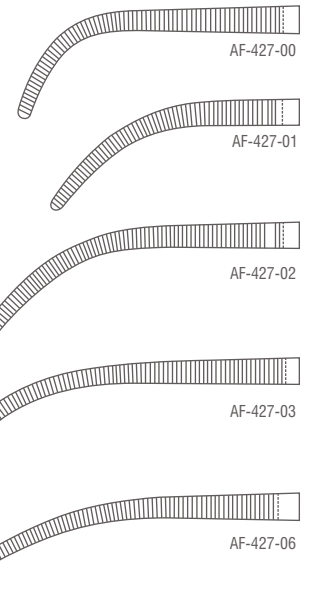

Catalog #	Size
AF-427-00	21.5 cm (8 1/2")
AF-427-01	21 cm (8 1/4")
AF-427-02	22 cm (8 3/4")
AF-427-03	23 cm (9")
AF-427-06	22.5 cm (8 3/4")

**Overholt Dissecting and Ligature Forcep**  
 Curved

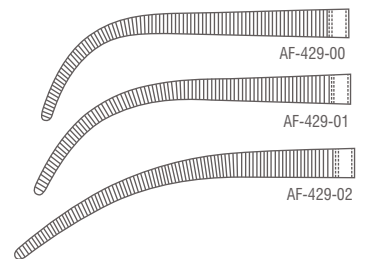

Catalog #	Size
AF-429-00	29.5 cm (11 1/2")
AF-429-01	29.5 cm (11 1/2")
AF-429-06	30 cm (11 3/4")





Dissecting and Ligature Forceps  
Präparierklemmen  
Pinzas para preparación y ligadura  
Pincas à disséquer et à ligatures  
Pinze per preparazioni e legature

**Overholt-Mini Dissecting and Ligature Forcep**  
Curve, S Shaped

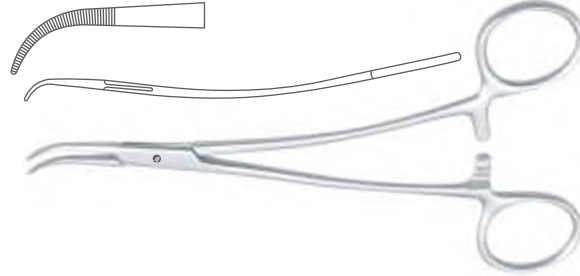

Catalog #	Size
AF-431-15	15 cm (6")

**Overholt-Mini Dissecting and Ligature Forcep**  
Curve



Catalog #	Size
AF-433-20	20 cm (8")

**Kelly Dissecting and Ligature Forcep**  
Fig. 1



Catalog #	Size
AF-441-19	19.5 cm (7 3/4")
AF-441-22	22.5 cm (8 3/4")
AF-441-24	24.5 cm (9 3/4")

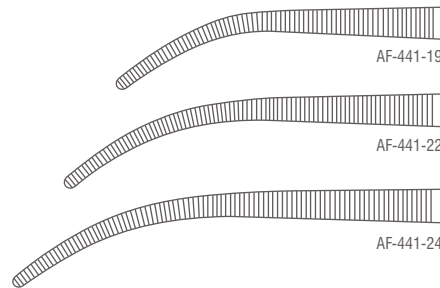



Dissecting and Ligature Forceps  
 Präparierklemmen  
 Pinzas para preparación y ligadura  
 Pinces à disséquer et à ligatures  
 Pinze per preparazioni e legature

**Kelly Dissecting and Ligature Forcep**  
 Fig. 2

Catalog #	Size
AF-443-19	19 cm (7 1/2")
AF-443-22	22 cm (8 3/4")
AF-443-24	24 cm (9 1/2")



**Kelly Dissecting and Ligature Forcep**  
 Fig. 3

Catalog #	Size
AF-445-19	18.5 cm (7 1/4")
AF-445-22	21.5 cm (8 1/2")
AF-445-24	23.5 cm (9 1/4")



**Lawrence Dissecting and Ligature Forcep**  
 Curved

Catalog #	Size
AF-451-28	28 cm (11")



**Meeker Dissecting and Ligature Forcep**  
 Right Angled

Catalog #	Size
AF-455-28	28 cm (11")







Dissecting and Ligature Forceps  
Präparierklemmen  
Pinzas para preparación y ligadura  
Pinces à disséquer et à ligatures  
Pinze per preparazioni e legature

**Mini-Gemini Dissecting and Ligature Forcep**  
Curved

Catalog #	Size
AF-469-18	18 cm (7")
AF-469-22	22.5cm (8 ¾")
AF-469-25	25 cm (9 ¾")
AF-469-28	28.5 cm (11 ¼")



**Gemini Dissecting and Ligature Forcep**  
Curved

Catalog #	Size
AF-471-13	13 cm (5")
AF-471-16	16 cm (6 ¼")
AF-471-18	18 cm (7")
AF-471-20	21 cm (8 ¼")
AF-471-23	23 cm (9")
AF-471-25	25 cm (9 ¾")
AF-471-28	28 cm (11")



**Rumel Dissecting and Ligature Forcep**  
Curved

Catalog #	Size
AF-475-01	24 cm (9 ½")
AF-475-02	23.5 cm (9 ½")
AF-475-03	23 cm (9")
AF-475-04	24 cm (9 ½")
AF-475-05	23.5 cm (9 ¼")

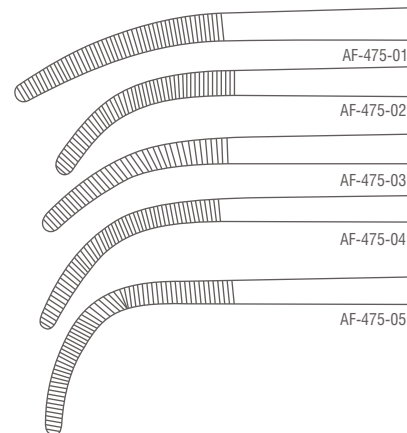



Dissecting and Ligature Forceps  
 Präparierklemmen  
 Pinzas para preparación y ligadura  
 Pinces à disséquer et à ligatures  
 Pinze per preparazioni e legature

**Zenker Dissecting and Ligature Forcep Curved**

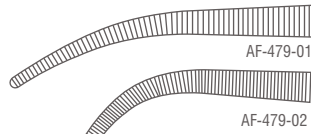

Catalog #	Size
AF-479-01	29.5 cm (11 1/2")
AF-479-02	28.5 cm (11 1/4")



**Kieback Dissecting and Ligature Forcep Curved**



Catalog #	Size
AF-481-23	23.5 cm (9 1/4")



**Mixer-Baby Dissecting and Ligature Forcep Gently Curved**



Catalog #	Size
AF-491-01	13.5 cm (5 1/4")



**Mixer-Baby Dissecting and Ligature Forcep Strongly Curved**

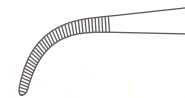

Catalog #	Size
AF-491-02	13 cm (5")



**Mixer-Baby Dissecting and Ligature Forcep Curved**

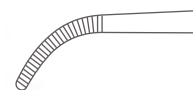

Catalog #	Size
AF-493-14	13.5 cm (5 1/4")





Dissecting and Ligature Forceps  
Präparierklemmen  
Pinzas para preparación y ligadura  
Pinces à disséquer et à ligatures  
Pinze per preparazioni e legature

**Mixer-Baby Dissecting and Ligature Forcep**  
Curved



Catalog #	Size
AF-495-18	18.5 cm (7 1/4")

**Mixer Dissecting and Ligature Forcep**  
Right Angled



Catalog #	Size
AF-497-15	16 cm (6 1/4")
AF-497-19	18 cm (7")

**Mixer Dissecting and Ligature Forcep**  
Curved

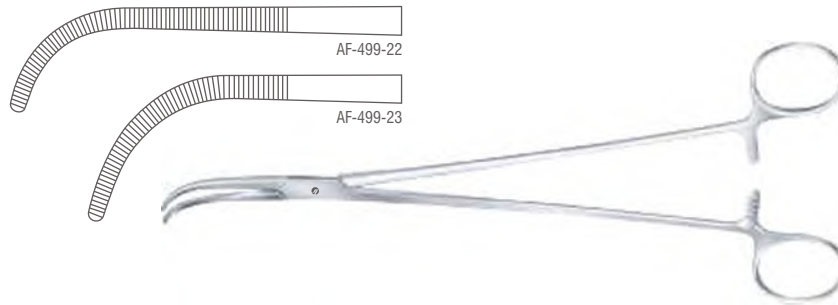

Catalog #	Size
AF-499-22	22.5 cm (8 3/4")
AF-499-23	23 cm (9")

**Mixer Dissecting and Ligature Forcep**  
Right Angled, Longitudinally Serrated



Catalog #	Size
AF-501-22	22.5 cm (8 3/4")
AF-501-25	26 cm (10 1/4")
AF-501-28	28 cm (11")



Dissecting and Ligature Forceps  
 Präparierklemmen  
 Pinzas para preparación y ligadura  
 Pinces à disséquer et à ligatures  
 Pinze per preparazioni e legature

**McQuigg-Mixer Dissecting and Ligature Forcep**  
 Right Angled, Longitudinally Serrated

Catalog #	Size
AF-505-22	23.5 cm (9 1/4")



**Mixer-O'Shaughnessy Dissecting and Ligature Forcep**  
 Curved

Catalog #	Size
AF-509-19	18.5 cm (7")



**O'Shaughnessy Dissecting and Ligature Forcep**  
 Curved

Catalog #	Size
AF-511-14	15 cm (6")
AF-511-17	18 cm (7")
AF-511-20	20 cm (8")
AF-511-23	23 cm (9")
AF-511-26	26 cm (10 1/4")

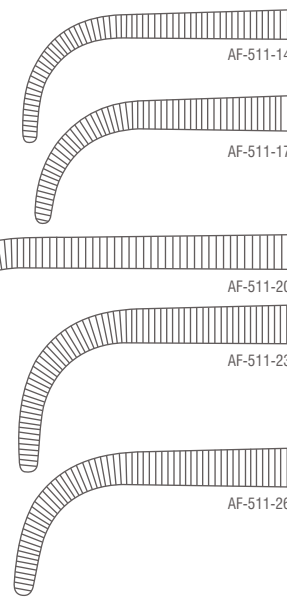



Dissecting and Ligature Forceps  
Präparierklemmen  
Pinzas para preparación y ligadura  
Pinces à disséquer et à ligatures  
Pinze per preparazioni e legature

**Wickstroem Dissecting and Ligature Forcep**  
Right Angled

Catalog #	Size
AF-517-21	21 cm (8 ¼")
AF-517-24	24.5 cm (9 ¾")



**Lahey Dissecting and Ligature Forcep**  
Curved

Catalog #	Size
AF-519-18	18.5 cm (7 ¼")



**Kantrowitz Dissecting and Ligature Forcep**  
Right Angled

Catalog #	Size
AF-523-20	20 cm (8")
AF-523-25	25 cm (9 ¾")
AF-523-27	27.5 cm (10 ¾")



**Barre Dissecting and Ligature Forcep**  
Extra Delicate

Catalog #	Size
AF-527-28	28 cm (11")



**Barre Dissecting and Ligature Forcep**  
Delicate

Catalog #	Size
AF-529-28	28 cm (11")





Bile Duct Clamps, Dissecting and Ligature Forceps  
 Gallenkanalklemmen, Präparierklemmen  
 Pinzas para conducto biliar, Pinzas para preparación y ligadura  
 Pinces pour les voies biliaires, Pinces à disséquer et à ligatures  
 Pinze per vie biliari, Pinze per preparazioni e legature

**Lahey (Sweet) Bile Duct Clamp**  
 Curved



Catalog #	Size
AF-535-19	19.5 cm (7 3/4")

**Lahey Bile Duct Clamp**  
 Angled



Catalog #	Size
AF-537-23	22.5 cm (8 3/4")

**Lahey (Sweet) Bile Duct Clamp**  
 Curved

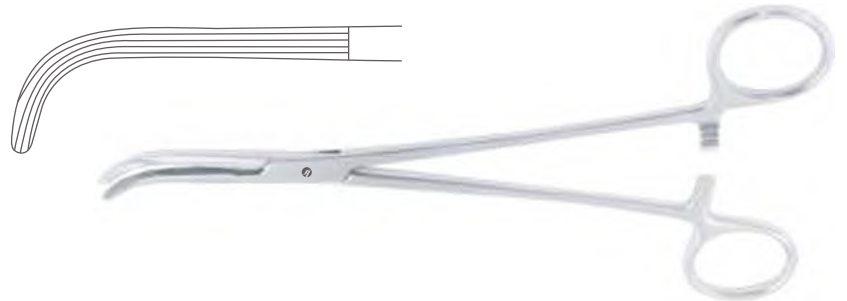

Catalog #	Size
AF-539-23	23 cm (9")

**Finochietto Dissecting and Ligature Forcep**  
 Right Angled

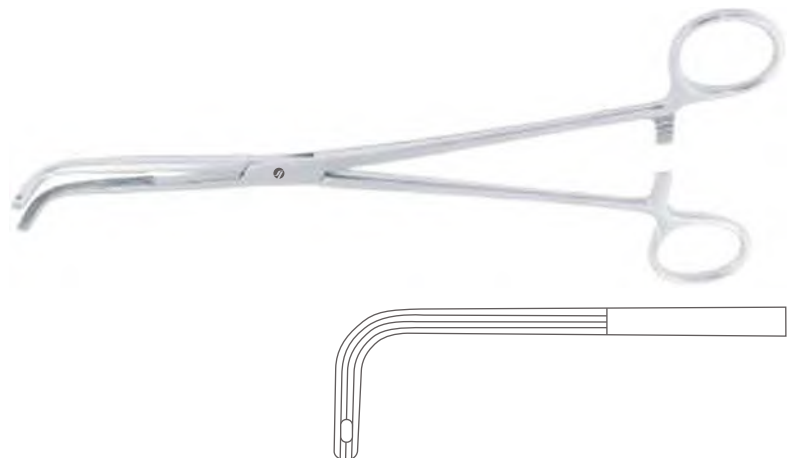

Catalog #	Size
AF-541-24	24 cm (9 1/2")



Tangential Forceps, Kidney Pedicle Clamps  
Tangentialklemmen, Nierenstielklemmen  
Pinzas tangenciales, Pinzas para pedículo renal  
Pinces tangentielles, Pince-clamps pour pédicules rénaux  
Pinze tangenziali, Pinze per peduncoli renali

**Uro-Tangential Atrauma Tangential Forcep**

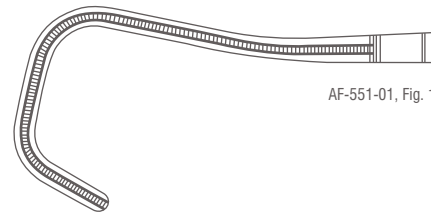

AF-551-01, Fig. 1

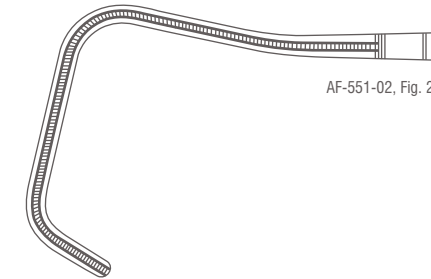

AF-551-02, Fig. 2

Catalog #	Size, Profile
AF-551-01	25 cm (9 3/4"), Fig. 1
AF-551-02	27 cm (10 3/4"), Fig. 2

**Guyon Atrauma Kidney Pedicle Clamp**  
Curved

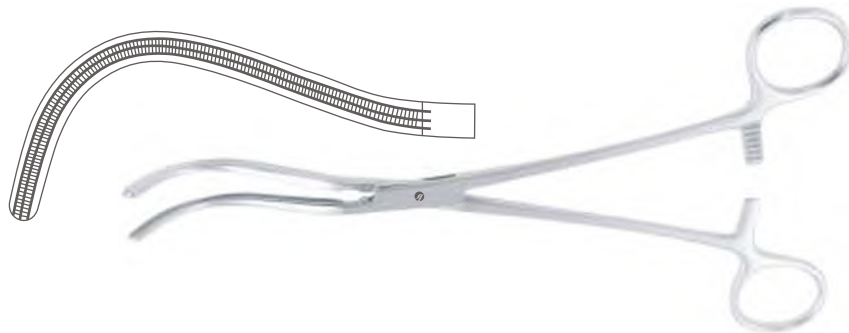

Catalog #	Size
AF-561-23	23 cm (9")
AF-561-24	24 cm (9 1/2")

**Guyon Kidney Pedicle Clamp**  
Curved

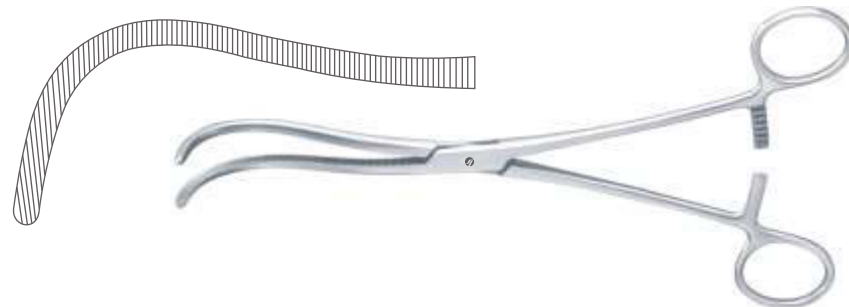

Catalog #	Size
AF-563-23	24 cm (9 1/2")





Kidney Pedicle Clamps, Bile Duct Clamps  
 Nierenstielklemmen, Gallenkanalklemmen  
 Pinzas para pedículo renal, Pinzas para conducto biliar  
 Pince-clamps pour pédicules rénaux, Pincas pour les voies biliaires  
 Pinze per peduncoli renali, Pinze per vie biliari

**Guyon Kidney Pedicle Clamp**  
 Curved

Catalog #	Size
AF-565-20	19.5 cm (7 3/4")
AF-565-22	21.5 cm (8 1/2")
AF-565-24	24 cm (9 1/2")

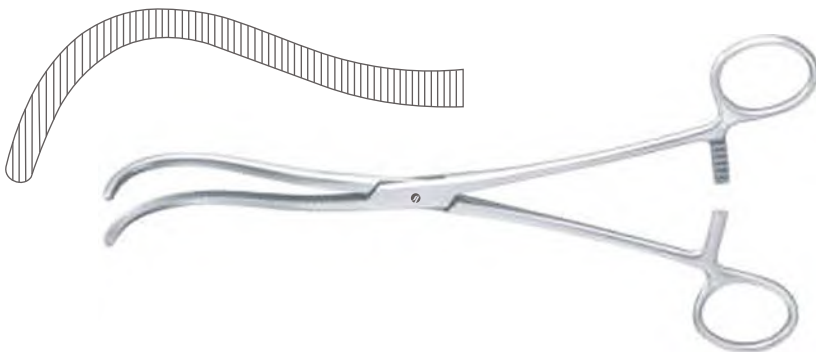

**Stille Kidney Pedicle Clamp**  
 Curved, Grooved

Catalog #	Size
AF-569-23	23 cm (9")

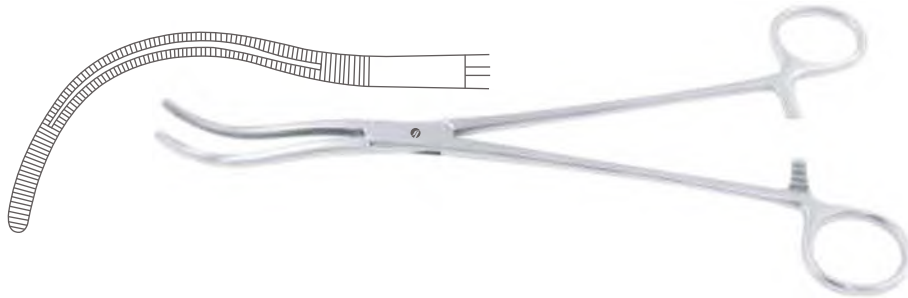

**Herrick Kidney Pedicle Clamp**  
 Double Angled, Longitudinally Serrated

Catalog #	Size
AF-571-23	23 cm (9")



**Desjardins Bile Duct Clamp**  
 Curved Downwards

Catalog #	Size
AF-581-21	21 cm (8 1/4")



**Nissen Bile Duct Clamp**  
 Curved Downwards

Catalog #	Size
AF-583-21	21.5 cm (8 1/2")







Dissecting and Ligature Forceps, Hysterectomy Forceps  
 Präparierklemmen, Hysterektomieklemmen  
 Pinzas para preparación y ligadura, Pinzas para histerectomía  
 Pincas à disséquer et à ligatures, Pincas à hystérectomie  
 Pinze per preparazioni e legature, Pinze per isterectomia

**Gray Dissecting and Ligature Forcep**  
Curved S Shaped

Catalog #	Size
AF-591-01	22 cm (8 3/4")
AF-591-02	22 cm (8 3/4")



**Phaneuf Hysterectomy Forcep**  
Straight, 1 x 2 Teeth

Catalog #	Size
AF-594-21	20.5 cm (8")



**Phaneuf Hysterectomy Forcep**  
Curved, 1 x 2 Teeth

Catalog #	Size
AF-595-21	20 cm (8")



**Maingot Hysterectomy Forcep**  
Curved, 1 x 2 Teeth

Catalog #	Size
AF-597-20	20.5 cm (8")
AF-597-25	25 cm (9 3/4")



**Maingot Hysterectomy Forcep**  
Straight, 1 x 2 Teeth

Catalog #	Size
AF-598-20	20 cm (8")





Hysterectomy Forceps  
Hysterektomieklappen  
Pinzas para histerectomia  
Pinces à hysterectomie  
Pinze per isterectomia

**Heaney-Ballentine Hysterectomy Forcep**  
Straight



Catalog #	Size
AF-600-21	21.5 cm (8 1/2")

**Heaney-Ballentine Hysterectomy Forcep**  
Curved

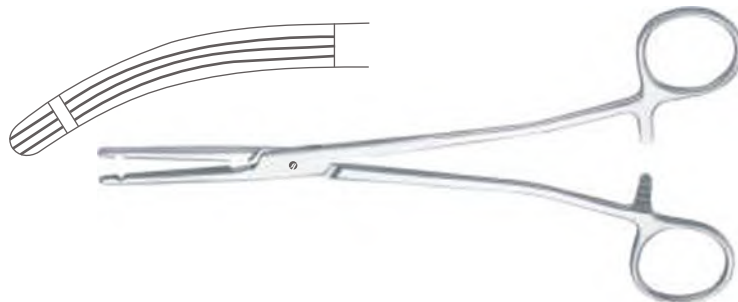

Catalog #	Size
AF-601-21	21.5 cm (8 1/2")

**Heaney-Razek Hysterectomy Forcep**  
Straight

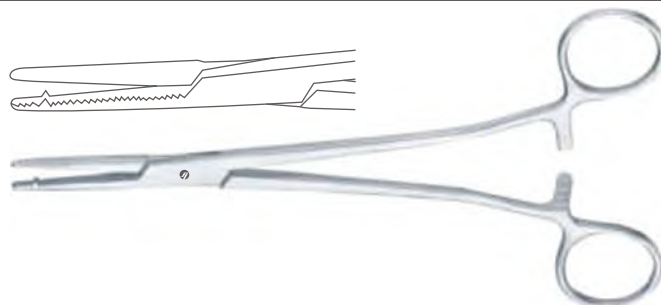

Catalog #	Size
AF-604-21	21 cm (8 1/4")

**Heaney Hysterectomy Forcep**  
Curved, 1 Tooth



Catalog #	Size
AF-607-19	19.5 cm (7 3/4")
AF-607-21	21.5 cm (8 1/2")
AF-607-23	24 cm (9 1/2")



Hysterectomy Forceps  
Hysterektomieklemmen  
Pinzas para histerectomia  
Pinces à hystérectomie  
Pinze per isterectomia

**Heaney Hysterectomy Forcep**  
Curved, 2 Tooth

Catalog #	Size
AF-609-19	19.5 cm (7 ¾")
AF-609-21	21.5 cm (8 ½")
AF-609-23	24 cm (9 ½")



**Dick Atrauma Vaginal Clamp**  
Angled

Catalog #	Size
AF-621-25	25.5 cm (10")
AF-621-26	26.5 cm (10 ½")
AF-621-27	27.5 cm (10 ¾")

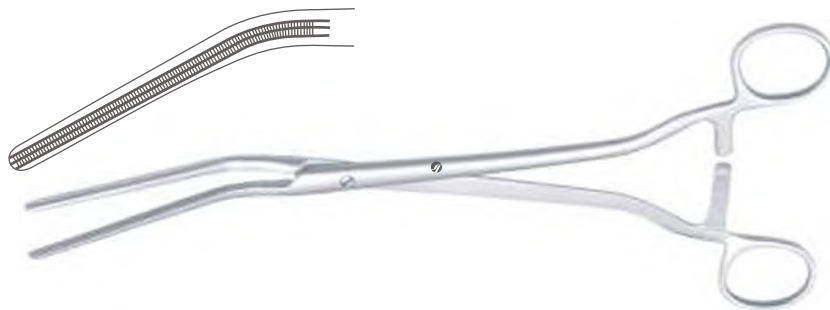

**Wertheim Atrauma Vaginal Clamp**  
Right Angled

Catalog #	Size
AF-625-25	25 cm (9 ¾")



**Wertheim-Cullen Vaginal Clamp**

Catalog #	Size
AF-629-21	21 cm (8 ¼")





Hysterectomy Forceps  
Hysterektomieklammen  
Pinzas para histerectomia  
Pinces à hystérectomie  
Pinze per isterectomia

**Heaney (Rogers) Hysterectomy Forcep**



AF-635-10, Fig. 1



AF-635-20, Fig. 2

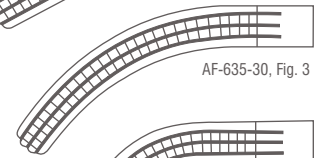

AF-635-30, Fig. 3

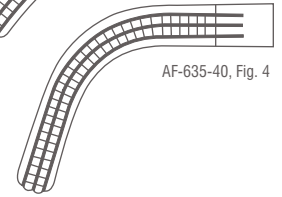

AF-635-40, Fig. 4

Catalog #	Size
AF-635-10	21.5 cm (8 1/2"), Fig. 1
AF-635-20	21 cm (8 1/4"), Fig. 2
AF-635-30	20.5 cm (8"), Fig. 3
AF-635-40	20 cm (8"), Fig. 4

**Wertheim (Rogers) Hysterectomy Forcep**

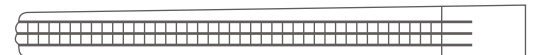

AF-637-10, Fig. 1

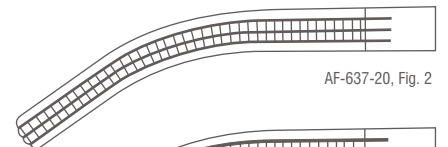

AF-637-20, Fig. 2

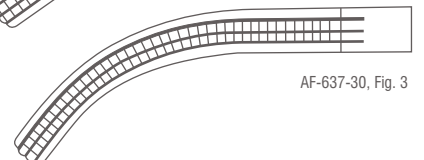

AF-637-30, Fig. 3

Catalog #	Size
AF-637-10	25.5 cm (10"), Fig. 1
AF-637-20	25 cm (9 3/4"), Fig. 2
AF-637-30	24.5 cm (9 3/4"), Fig. 3



Hysterectomy Forceps  
Hysterektomieklemmen  
Pinzas para histerectomia  
Pinces à hystérectomie  
Pinze per isterectomia

**Wertheim Hysterectomy Forcep**  
Angled

Catalog #      Size  
AF-639-22      22 cm (8 3/4")



**Segond-Landau Hysterectomy Forcep**  
Straight

Catalog #      Size  
AF-642-24      24 cm (9 1/2")



**Segond Hysterectomy Forcep**  
Curved

Catalog #      Size  
AF-643-24      24 cm (9 1/2")



**Holzbach Hysterectomy Forcep**  
Straight

Catalog #      Size  
AF-646-24      24.5 cm (9 3/4")



**Holzbach Hysterectomy Forcep**  
Curved

Catalog #      Size  
AF-647-24      24.5 cm (9 3/4")





Hysterectomy Forceps  
Hysterektomieklemmen  
Pinzas para histerectomía  
Pinces à hystérectomie  
Pinze per isterectomia

**Gwilliam Hysterectomy Forcep**  
Straight

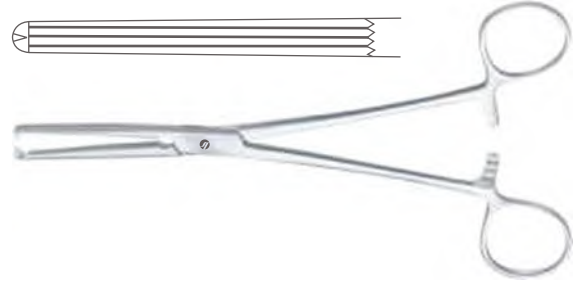

Catalog #	Size
AF-648-20	20 cm (8")

**Gwilliam Hysterectomy Forcep**  
Curved

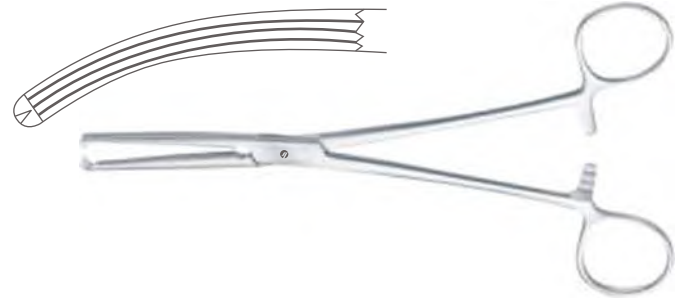

Catalog #	Size
AF-649-20	20 cm (8")

**Berkeley-Bonney Hysterectomy Forcep**  
Curved

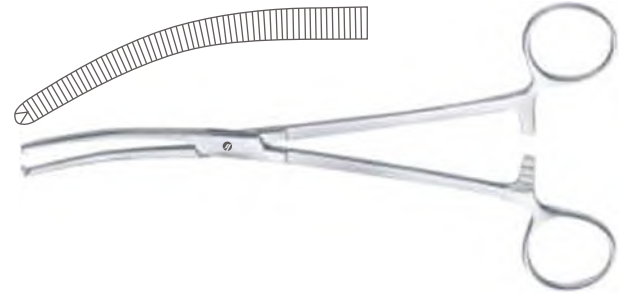

Catalog #	Size
AF-651-20	20 cm (8")

**Kieback Hysterectomy Forcep**  
Straight

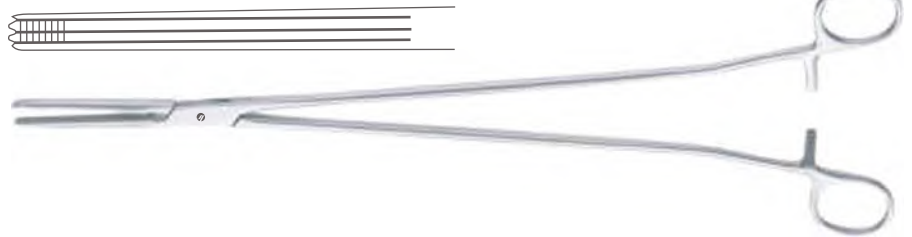

Catalog #	Size
AF-654-25	25 cm (9 3/4")

**Kieback Hysterectomy Forcep**  
Curved

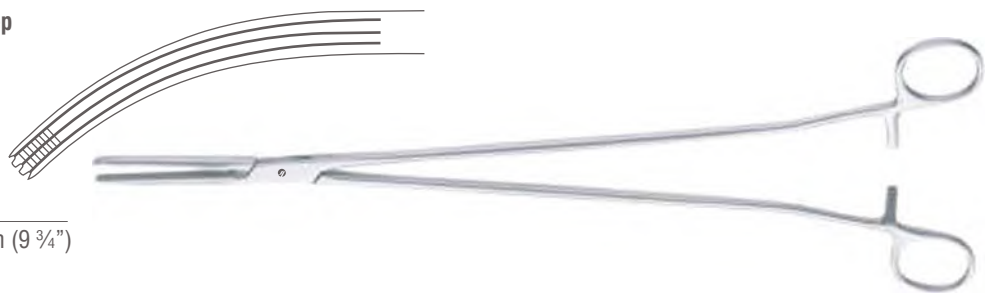

Catalog #	Size
AF-655-25	25 cm (9 3/4")





Hysterectomy Forceps  
Hysterektomieklemmen  
Pinzas para histerectomia  
Pinces à hystérectomie  
Pinze per isterectomia

**Burke Hysterectomy Forcep**  
Curved, Short Jaws

Catalog #      Size  
AF-657-25      25 cm (9 3/4")

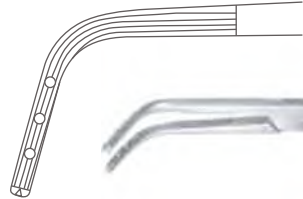

**Burke Hysterectomy Forcep**  
Curved, Long Jaws

Catalog #      Size  
AF-659-25      25 cm (9 3/4")

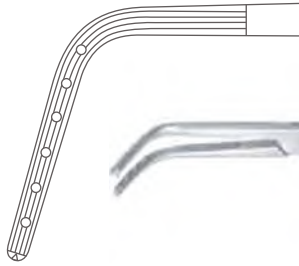

**Moynihan Hysterectomy Forcep**  
Curved

Catalog #      Size  
AF-661-23      23 cm (9")

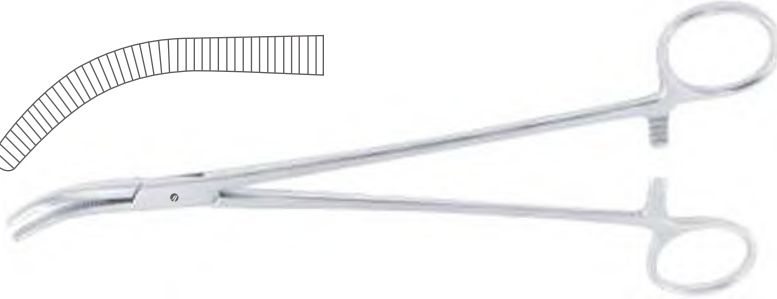

**Moynihan Hysterectomy Forcep**  
Curved

Catalog #      Size  
AF-663-24      23.5 cm (9 1/4")

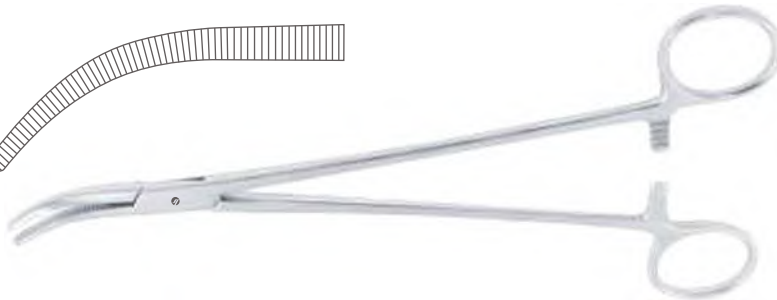
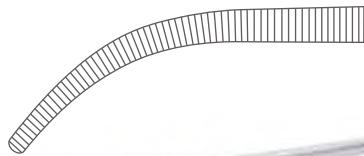

**Wertheim Hysterectomy Forcep**  
Curved

Catalog #      Size  
AF-667-25      26 cm (10 1/4")

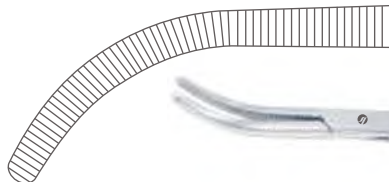



Hysterectomy Forceps, Peritoneum Forceps  
 Hysterektomieklemmen, Peritoneumklemmen  
 Pinzas para histerectomia, Pinzas para peritoneo  
 Pincas à hystérectomie, Pince pour le péritoine  
 Pinze per isterectomia, Pinze per peritoneo

**Wertheim Hysterectomy Forcep**  
 Curved , 1 x 2 Teeth

Catalog #	Size
AF-669-22	22.5 cm (8 ¾")



**Wertheim Hysterectomy Forcep**  
 Curved , 1 x 2 Teeth

Catalog #	Size
AF-671-23	22.5 cm (8 ¾")



**Fergusson Angiotribe**  
 Straight

Catalog #	Size
AF-680-16	16 cm (6 ¼")
AF-680-20	20 cm (8")

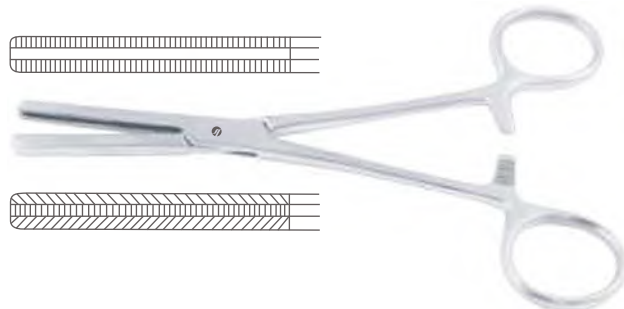

**Fergusson Angiotribe**  
 Curved

Catalog #	Size
AF-681-16	16 cm (6 ¼")
AF-681-20	20 cm (8")

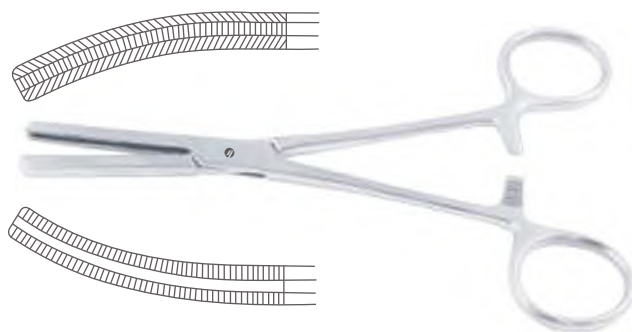

**Mikulicz-Baby Peritoneum Forcep**  
 Curved, 1 x 2 Teeth

Catalog #	Size
AF-685-14	14 cm (5 ¾")

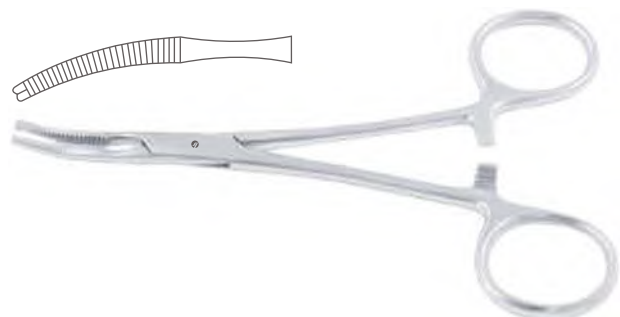





Peritoneum Forceps  
Peritoneumklemmen  
Pinzas para peritoneo  
Pince pour le péritoine  
Pinze per peritoneo

AF

ARTERY FORCEP

**Mikulicz Peritoneum Forcep**  
Curved, 1 x 2 Teeth

Catalog #	Size
AF-687-18	18.5 cm (7 1/4")

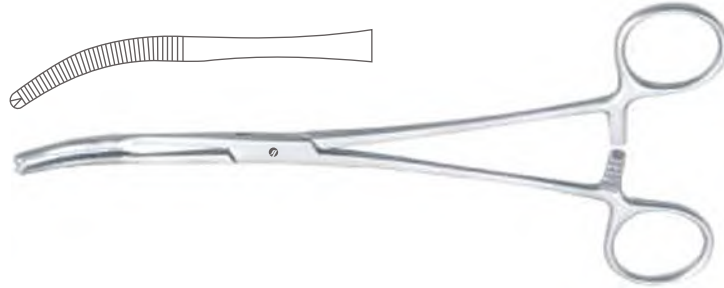

**Mikulicz Peritoneum Forcep**  
Curved, 1 x 2 Teeth

Catalog #	Size
AF-689-20	20 cm (8")

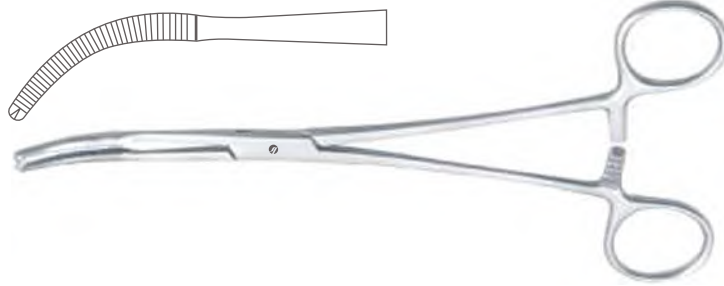

**Mikulicz Peritoneum Forcep**  
Curved, 1 x 2 Teeth

Catalog #	Size
AF-691-20	20 cm (8")

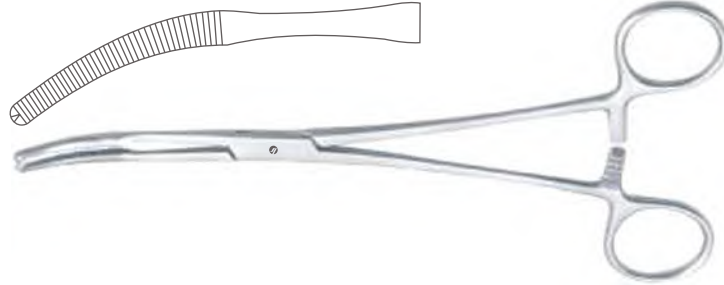

**Mikulicz Peritoneum Forcep**  
Curved, Longitudinal Serrations, 1 x 2 Teeth

Catalog #	Size
AF-693-24	24.5 cm (9 3/4")

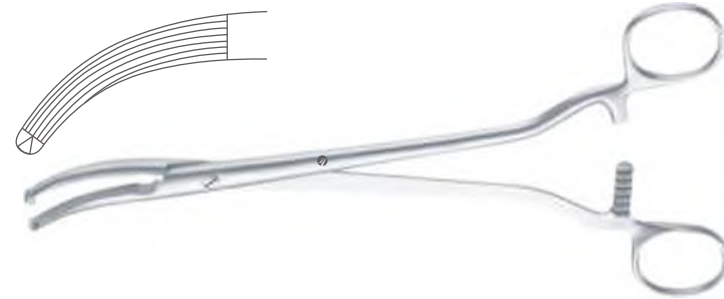

**Mikulicz Peritoneum Forcep**  
Curved, 1 x 2 Teeth

Catalog #	Size
AF-695-21	20.5 cm (8")

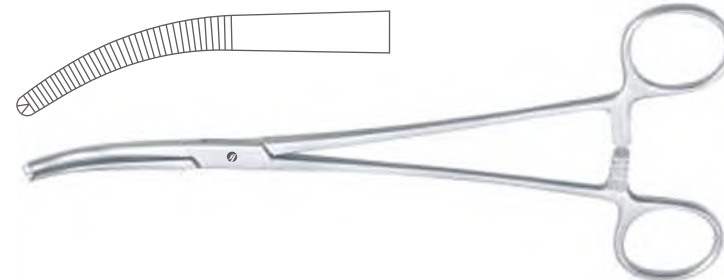



Peritoneum Forceps, Towel Clamps  
 Peritoneumklemmen, Tuchklemmen  
 Pinzas para peritoneo, Pinzas de campo  
 Pince pour le péritoine, Pince à champs  
 Pinze per peritoneo, Pinze fissatele

**Faure Peritoneum Forcep**  
 Curved , 1 x 2 Teeth



Catalog #	Size
AF-697-20	21 cm (8 1/4")

**Faure Peritoneum Forcep**  
 Curved , 1 x 2 Teeth



Catalog #	Size
AF-699-20	21 cm (8 1/4")

**Doyen Towel Clamp**



Catalog #	Size
AF-751-18	18 cm (7")

**Schaedel Towel Clamp**  
 Sharp



Catalog #	Size
AF-755-09	9 cm (3 1/2")

**Jones Towel Clamp**  
 Sharp



Catalog #	Size
AF-761-05	5.5 cm (2 1/2")
AF-761-09	8.5 cm (3 1/4")



Towel Clamps  
Tuchklemmen  
Pinzas de campo  
Pinces à champs  
Pinze fissatele

**Martin-Jones Towel Clamp**  
Sharp, With Cable Holder



Catalog #	Size
AF-765-09	8.5 cm (3 1/4")

**Robin Towel Clamp**  
With Cable Holder



Catalog #	Size, Usage
AF-769-01	13.5 cm (5 1/4"), For Cable Up To 5 mm
AF-769-02	13.5 cm (5 1/4"), For Cable Up To 13 mm

**Backhaus Towel Clamp**  
With Tube Holder

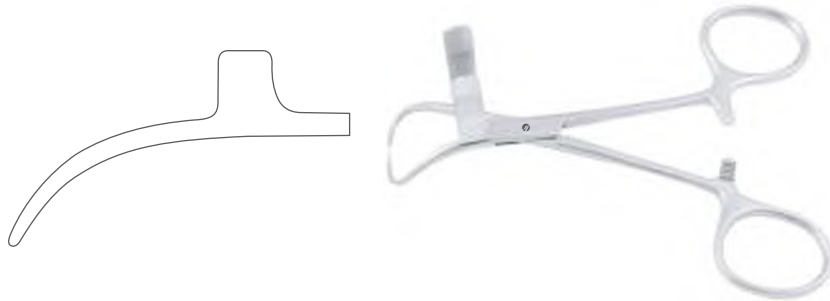

Catalog #	Size
AF-771-11	13 cm (5")

**Backhaus Towel Clamp**



Catalog #	Size
AF-773-08	9 cm (3 1/2")
AF-773-11	11.5 cm (4 1/2")
AF-773-13	13 cm (5")
AF-773-15	16 cm (6 1/4")



Towel Clamps  
Tuchklemmen  
Pinzas de campo  
Pinces à champs  
Pinze fissatele

**Roeder Towel Clamp**



Catalog #	Size
AF-777-13	13.5 cm (5 1/4")

**Lorna Towel Clamp**  
Fine Serrated, Wide Jaw



Catalog #	Size
AF-781-10	9.5 cm (3 3/4")
AF-781-13	13 cm (5")

**Bernhard Towel Clamp**



Catalog #	Size
AF-785-16	16.5 cm (6 1/2")

**Tohoku Towel Clamp**  
Blunt



Catalog #	Size
AF-787-10	10.5 cm (4")
AF-787-13	13.5 cm (5 1/4")

**Non Perforating Towel Clamp**



Catalog #	Size
AF-791-10	10 cm (4")
AF-791-13	13.5 cm (5 1/4")



Towel Clamps, Tubing Clamps  
Tuchklemmen, Schlauchklemmen  
Pinzas de campo, Pinzas para tubos  
Pinces à champs, Pinces presse-tubes  
Pinze fissatele, Pinze serratubi

**Peers-Bretram Towel Clamp**  
With Jaw for Tube Fixation

Catalog #	Size
AF-793-14	14.5 cm (5 ¾")

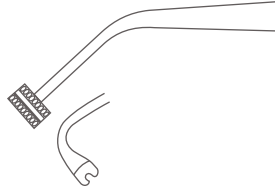

**Towel Clamp**  
For Paper Clothes

Catalog #	Size
AF-795-11	11.5 cm (4 ½")
AF-795-14	14 cm (5 ½")



**Lane Towel Clamp**

Catalog #	Size
AF-799-13	13 cm (5")
AF-799-15	15.5 cm (6")
AF-799-20	19.5 cm (7 ¾")

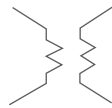

**Klinikum Berlin Tubing Clamp**  
Extra Long Ratchet

Catalog #	Size
AF-850-14	14 cm (5 ½")





Tubing Clamps  
Schlauchklemmen  
Pinzas para tubos  
Pinces presse-tubes  
Pinze serratubi

**Presbyterian Tubing Clamp**

Catalog #	Size
AF-852-16	16.5 cm (6 1/2")
AF-852-18	18 cm (7")

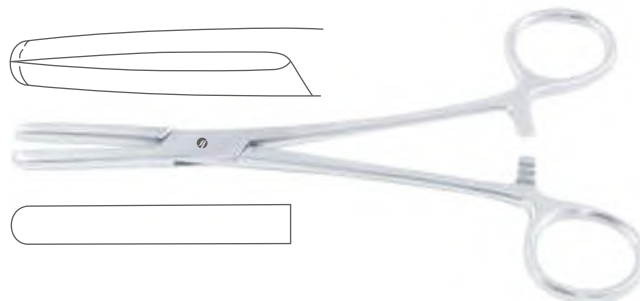

**Tubing Clamp**

Catalog #	Size
AF-860-15	15.5 cm (6")
AF-860-18	19 cm (7 1/2")
AF-860-20	20.5 cm (8")



**Tubing Clamp  
With Safety Guard**

Catalog #	Size
AF-862-15	15.5 cm (6")
AF-862-18	19 cm (7 1/2")
AF-862-20	20.5 cm (8")



**Brompton Tube Milking Roller**

Catalog #	Size
AF-890-00	Standard





Tubing Clamps  
Schlauchklemmen  
Pinzas para tubos  
Pinces presse-tubes  
Pinze serratubi

**Hoffmann Tubing Clamp**

Catalog #	Width
AF-950-13	13 mm
AF-950-17	17 mm
AF-950-20	20 mm
AF-950-25	25 mm
AF-950-30	30 mm
AF-950-40	40 mm



**Mohr Pinchcocks**

Catalog #	Width
AF-953-40	40 mm
AF-953-50	50 mm
AF-953-60	60 mm
AF-953-70	70 mm
AF-953-80	80 mm









**SURTEX**  
INSTRUMENTS

*Crafted to Excellence*

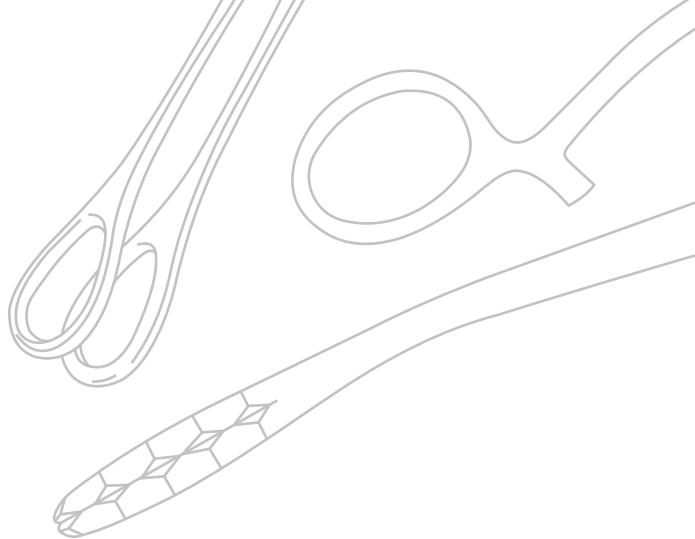

SF



## COTTON SWAB AND DRESSING FORCEPS

Surtex sponge forceps are the perfect choice for holding swabs or sponges in medical procedures. Our range is manufactured in box-joint scissor action with ratcheted handles and looped, smooth or serrated jaws, curved or straight to meet your specific purpose. Many surgeons prefer to use Surtex sponge forceps because they help prevent trauma during surgery by enabling the physician to hold and move tissue very precisely and gently.

Tupfer und Kornzangen

Pizas para tapones y -curaciones

Pinces à tampons et à pansements

Pinze per tamponi e per medicazione



Dressing Forceps  
Tupferzangen  
Pinzas para tapones  
Pinces à tampons  
Pinze per tamponi

**Ulrich Dressing Forcep**  
Straight

Catalog #	Size
SF-100-22	22.5 cm (8 ¾")
SF-100-27	26.5 cm (10 ½")



**Ulrich Dressing Forcep**  
Curved

Catalog #	Size
SF-101-22	22.5 cm (8 ¾")
SF-101-27	26.5 cm (10 ½")



**Bryant Dressing Forcep**  
Curved

Catalog #	Size
SF-111-13	13 cm (5")



**Lister Sinus Forcep**  
Straight

Catalog #	Size
SF-120-13	13 cm (5")
SF-120-16	16 cm (6 ¼")
SF-120-18	17 cm (7")



**Martin Dressing Forcep**  
Straight

Catalog #	Size
SF-130-17	17.5 cm (7")





Dressing Forceps  
Tupferzangen  
Pinzas para tapones  
Pincas à tampons  
Pinze per tamponi

SF

COTTON SWAB AND DRESSING FORCEPS

**Martin Dressing Forcep**  
Curved

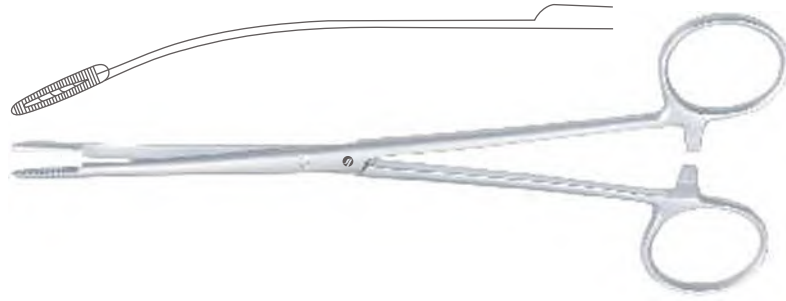

Catalog #	Size
SF-131-17	17 cm (6 3/4")

**Gross-Maier Dressing Forcep**  
Straight, With Ratchet



Catalog #	Size
SF-150-20	20.5 cm (8")
SF-150-22	22 cm (8 3/4")
SF-150-27	26.5 cm (10 1/2")

**Gross-Maier Dressing Forcep**  
Curved, With Ratchet

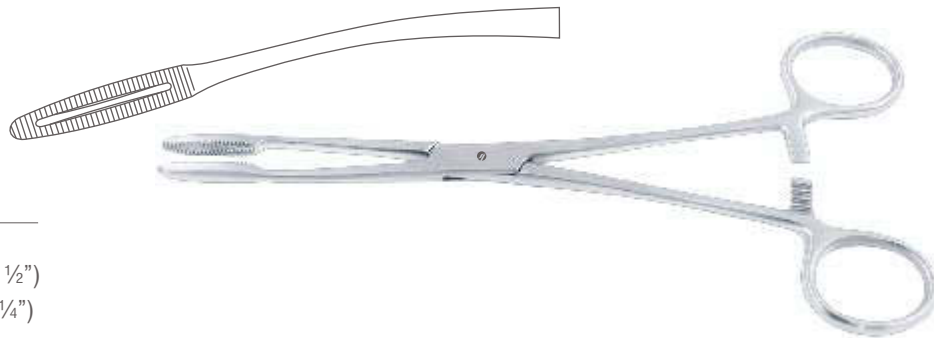

Catalog #	Size
SF-151-20	20 cm (8")
SF-151-22	21.5 cm (8 1/2")
SF-151-27	26 cm (10 1/4")

**Gross-Maier Dressing Forcep**  
Straight, Without Ratchet



Catalog #	Size
SF-152-20	20.5 cm (8")
SF-152-22	22 cm (8 3/4")
SF-152-27	26.5 cm (10 1/2")



Dressing Forceps  
Tupferzangen  
Pinzas para tapones  
Pinces à tampons  
Pinze per tamponi

**Gross-Maier Dressing Forcep**  
Curved, Without Ratchet

Catalog #	Size
SF-153-20	20 cm (8")
SF-153-22	21.5 cm (8 1/2")
SF-153-27	26 cm (10 1/4")



**Pelkmann Foreign Body Forcep**  
Straight

Catalog #	Size
SF-160-26	26 cm (10 1/4")

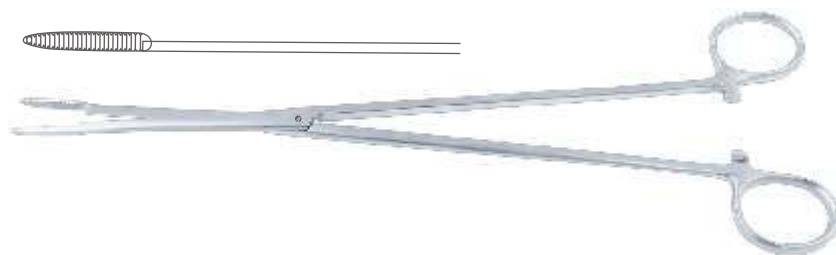

**Pelkmann Foreign Body Forcep**  
Curved

Catalog #	Size
SF-161-26	26 cm (10 1/4")

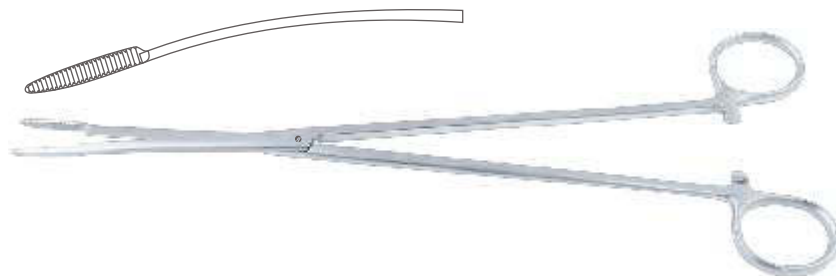

**Duplay Sponge Holding Forcep**  
Straight

Catalog #	Size
SF-164-21	21 cm (8 1/4")



**Duplay Sponge Holding Forcep**  
Curved

Catalog #	Size
SF-165-21	21 cm (8 1/4")





Dressing Forceps  
Tupferzangen  
Pinzas para tapones  
Pincas à tampons  
Pinze per tamponi

**Tunneling Forcep**  
Curved



Catalog #	Size
SF-171-40	39.5 cm (15 1/2")

**Collin Dressing Forcep**  
Straight

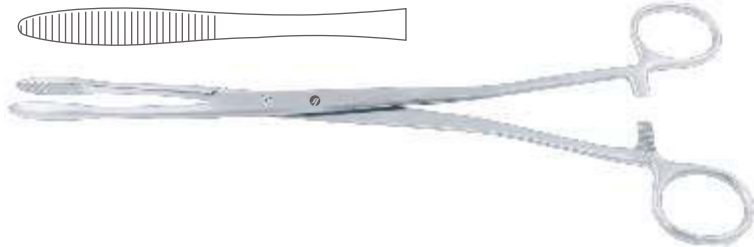

Catalog #	Size
SF-180-25	25.5 cm (10")

**Cheron Dressing Forcep**  
Straight

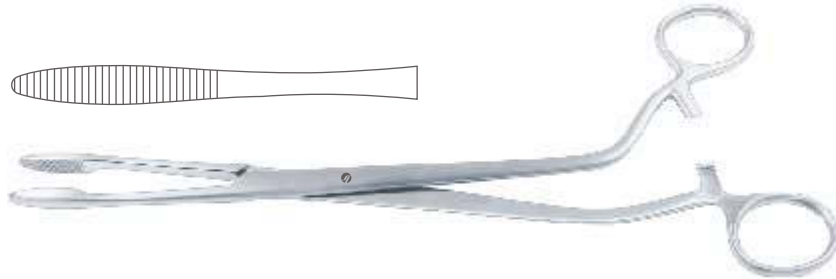

Catalog #	Size
SF-191-25	23.5 cm (9 1/4")

**Emmet Dressing Forcep**  
Straight

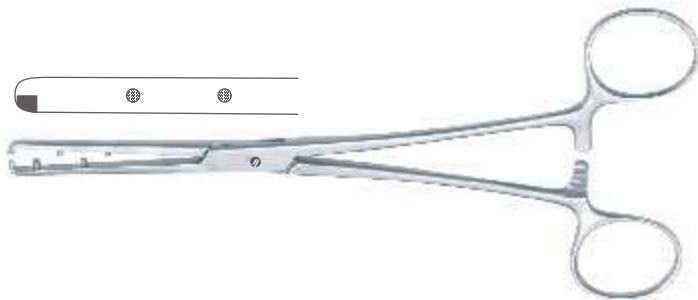

Catalog #	Size
SF-196-21	21 cm (8 1/4")

**Bozemann Sponge Holding Forcep**  
Straight

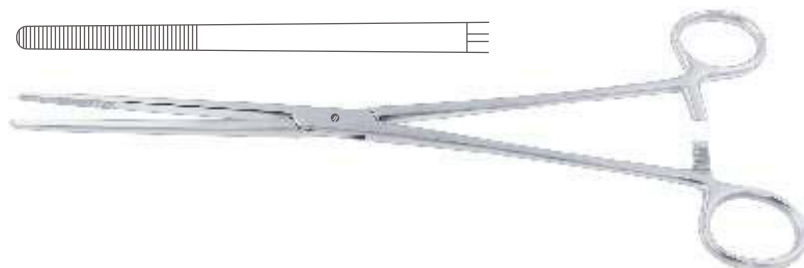

Catalog #	Size
SF-200-26	26 cm (10 1/4")



Dressing Forceps  
Tupferzangen  
Pinzas para tapones  
Pinces à tampons  
Pinze per tamponi

**Bozemann Sponge Holding Forcep**  
Curved S Shaped

Catalog #	Size
SF-201-26	26 cm (10 1/4")

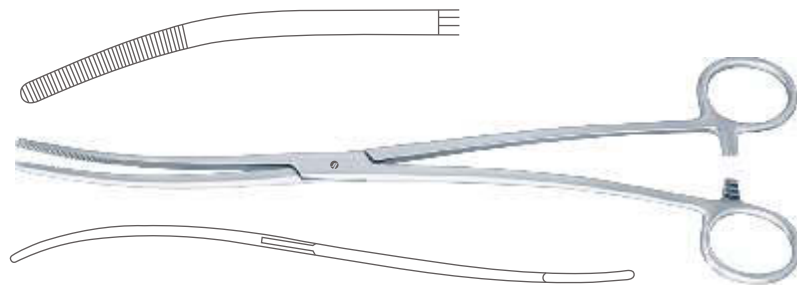

**Bozemann-Douglas Sponge Holding Forcep**  
Curved S Shaped

Catalog #	Size
SF-203-26	26 cm (10 1/4")

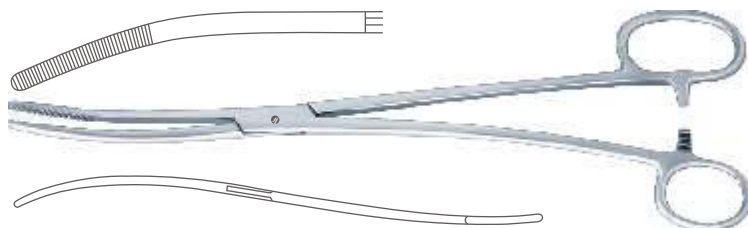

**Heywood-Smith Sponge Holding Forcep**  
Straight

Catalog #	Size
SF-220-20	20 cm (8")



**Heywood-Smith Sponge Holding Forcep**  
Straight

Catalog #	Size
SF-222-21	21 cm (8 1/4")



**Bergmann Sponge Holding Forcep**  
Straight

Catalog #	Size
SF-250-24	24 cm (9 1/2")





Dressing Forceps  
Tupferzangen  
Pinzas para tapones  
Pincas à tampons  
Pinze per tamponi

**Foerster Sponge Holding Forcep**  
Straight, Smooth Jaws

Catalog #	Size
SF-300-25	25 cm (9 3/4")



**Foerster Sponge Holding Forcep**  
Curved, Smooth Jaws

Catalog #	Size
SF-301-25	24.5 cm (9 3/4")

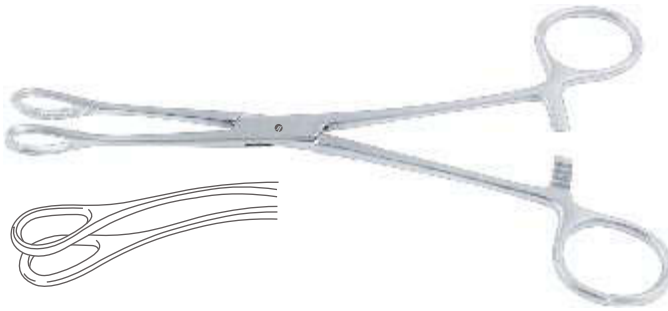

**Foerster Sponge Holding Forcep**  
Straight

Catalog #	Size
SF-350-18	18 cm (7")
SF-350-20	20.5 cm (8")
SF-350-25	25 cm (9 3/4")

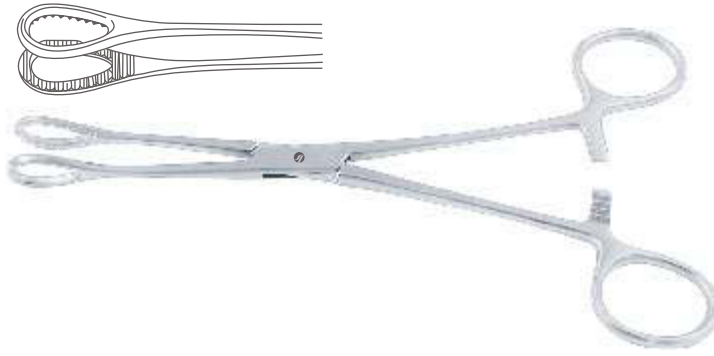

**Foerster Sponge Holding Forcep**  
Curved

Catalog #	Size
SF-351-18	17.5 cm (7")
SF-351-20	20 cm (8")
SF-351-25	24.5 cm (9 3/4")







Dressing Forceps  
Tupferzangen  
Pinzas para tapones  
Pinces à tampons  
Pinze per tamponi

**Foerster Sponge Holding Forcep  
Straight**

Catalog #	Size
SF-360-25	25 cm (9 3/4")



**Foerster Sponge Holding Forcep  
Curved**

Catalog #	Size
SF-361-25	24.5 cm (9 3/4")

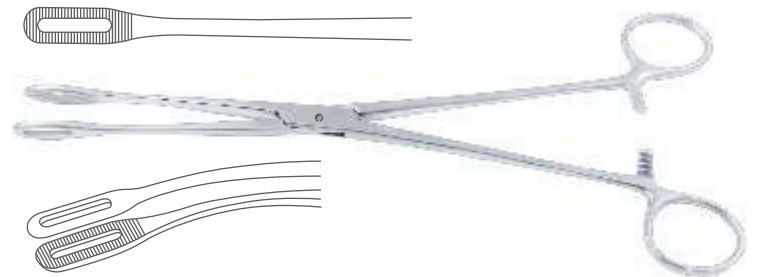

**Ramley Sponge Holding Forcep  
Straight**

Catalog #	Size
SF-380-18	18.5 cm (7 1/4")
SF-380-25	24.5 cm (9 3/4")







**SURTEX**  
INSTRUMENTS

*Crafted to Excellence*

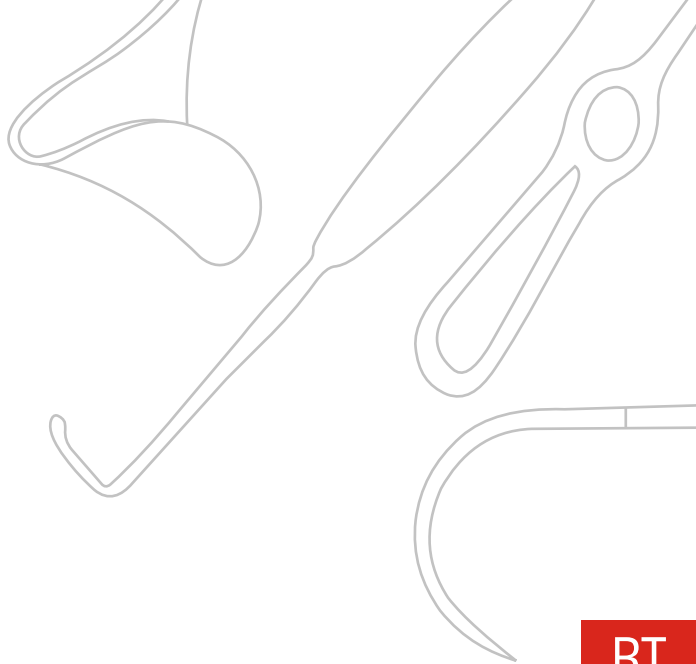

RT



## RETRACTORS

The retractor enables the surgeon to either actively separate the edges of a surgical incision or wound, or to hold back underlying organs and tissues, so that body parts under the incision may be accessed. Surtex instruments carry the most versatile range of retractors on the market.

Our range includes hand-held, self-retaining, table and chest mounted types for use in a range of delicate cardio vascular, ENT and general surgical procedures.

Our retractors have an ergonomic feel with specially designed teeth and blades to ensure a non-traumatic grip on sensitive tissue.

Wundhaken

Separadores

Ecarteurs

Divaricatori



Micro Hooklets, Skin Hooks  
Mikrohäkchen, Hauthäkchen  
Micro Ganchitos, Ganchitos de piel  
Micro Crochetes, Crochetes pour le peau  
Micro Divaricatori, Divaricatori per pelle

**Gillies Skin Hook**

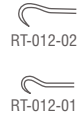

Catalog #	Size, Profile
RT-012-01	18 cm (7"), Fig. 1
RT-012-02	18 cm (7"), Fig. 2



**Kilner Skin Hook  
Sharp**



Catalog #	Size
RT-014-15	14.5 cm (5 3/4")



**Frazier Delicate Hook**



Catalog #	Size, Profile
RT-016-01	13 cm (5"), Sharp
RT-016-02	13 cm (5"), Blunt

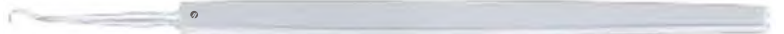

**Kleinert-Kutz Delicate Hook**



Catalog #	Size, Profile
RT-020-01	16 cm (6 1/4"), Fig. 1
RT-020-02	16 cm (6 1/4"), Fig. 2
RT-020-03	16 cm (6 1/4"), Fig. 3



**Graefe Delicate Hook**



Catalog #	Size, Profile
RT-024-01	15 cm (6"), Sharp
RT-024-02	15 cm (6"), Blunt

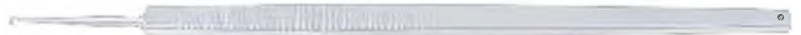



Skin Hooks, Hooklets  
Hauthäkchen, Wundhäkchen  
Ganchitos de piel, Ganchitos  
Crochetes pour le peau, Crochetes  
Divaricatori per pelle, Divaricatori

**Skin Hook**  
Sharp



Catalog #	Size, Profile
RT-026-01	16 cm (6 1/4"), Fig. 1
RT-026-02	16 cm (6 1/4"), Fig. 2
RT-026-03	16 cm (6 1/4"), Fig. 3
RT-026-04	16 cm (6 1/4"), Fig. 4



**O'Connor Skin Hook**  
Sharp



Catalog #	Size
RT-030-16	16 cm (6 1/4")



**Joseph Mucus Hook**  
Sharp



Catalog #	Size
RT-034-15	15.5 cm (6")



**Cottle Nasal Hook**  
Sharp



Catalog #	Size
RT-036-16	17 cm (6 3/4")



**Cottle Nasal Hook**  
Sharp



Catalog #	Size, Profile
RT-038-01	14.5 cm (5 3/4"), Fig. 1
RT-038-02	14.5 cm (5 3/4"), Fig. 2
RT-038-03	14.5 cm (5 3/4"), Fig. 3





Nerve Hooks  
Nervhaken  
Ganchos para nervios  
Crochets à nerfs  
Uncini per nervi

**Cushing Nerve Hook**  
Blunt



Catalog #	Size, Profile
RT-040-01	19 cm (7 1/2"), Fig. 1
RT-040-02	19.5 cm (7 3/4"), Fig. 2



**Cushing Nerve Hook**  
Blunt



Catalog #	Size, Profile
RT-042-01	28 cm (11"), Fig. 1
RT-042-02	28 cm (11"), Fig. 2



**Graefe Nerve Hook**  
Blunt

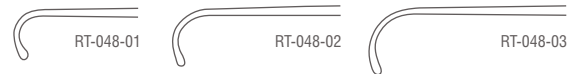

Catalog #	Size, Profile
RT-048-01	14 cm (5 1/2"), Fig. 1
RT-048-02	14 cm (5 1/2"), Fig. 2
RT-048-03	14 cm (5 1/2"), Fig. 3



**Crile Nerve Hook**



Catalog #	Size
RT-050-20	20 cm (8")

**Crile Nerve Hook**



Catalog #	Size
RT-052-20	20.5 cm (8")



Skin Hooks, Hooklets  
Hauthäkchen, Wundhäkchen  
Ganchitos de piel, Ganchitos  
Crochetes pour le peau, Crochetes  
Divaricatori per pelle, Divaricatori

**Guthrie Skin Retractor**  
Sharp



Catalog #	Size, Width
RT-060-01	15.5 cm (6"), 2.0 mm
RT-060-02	15.5 cm (6"), 3.0 mm

**Rollet Fine Wound Retractor**  
2 Sharp Prongs



Catalog #	Size, Width
RT-062-13	13 cm (5"), 4.5 mm

**Rollet Fine Wound Retractor**



Catalog #	Size, Width, Profile
RT-064-01	13.5 cm (5 1/4"), 7.0 mm, 4 Sharp Prongs
RT-064-02	13.5 cm (5 1/4"), 7.0 mm, 4 Blunt Prongs

**Knapp Fine Wound Retractor**  
4 Sharp Prongs

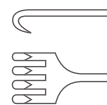

Catalog #	Size
RT-066-13	13.5 cm (5 1/4")

**Knapp Fine Wound Retractor**  
4 Blunt Prongs

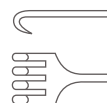

Catalog #	Size
RT-068-13	13.5 cm (5 1/4")



Hooklets  
Wundhäkchen  
Ganchitos  
Crochetes  
Divaricatori

**McIndoe Wound Retractor**  
2 Sharp Prongs

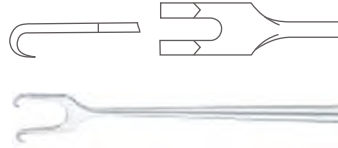

Catalog #	Size, Width
RT-070-01	15 cm (6"), 9.0 mm
RT-070-02	15 cm (6"), 10.0 mm

**Freer Mucus Hook**  
Sharp

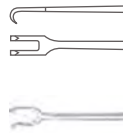

Catalog #	Size, Width
RT-072-15	15 cm (6"), 3.2 mm

**Joseph Mucus Hook**

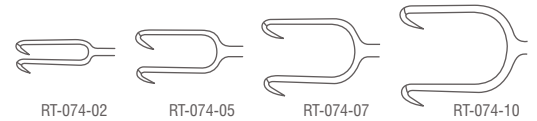

Catalog #	Size, Width
RT-074-02	16.5 cm (6 1/2"), 2.0 mm
RT-074-05	16.5 cm (6 1/2"), 5.0 mm
RT-074-07	16.5 cm (6 1/2"), 7.0 mm
RT-074-10	16.5 cm (6 1/2"), 10 mm



**Kilner Alar Hook**  
Sharp



Catalog #	Size
RT-076-10	8 cm (3 1/4")

**Converse Alar Hook**  
Sharp



Catalog #	Size
RT-078-12	11.5 cm (4 1/2")



Hooklets  
Wundhäkchen  
Ganchitos  
Crochetes  
Divaricatori

**Cottle Alar Hook**  
4 Semi Sharp Prongs

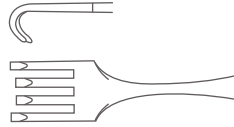

Catalog #	Size
RT-080-14	14 cm (5 1/2")

**Tissue Picker**  
2 Twisted Sharp Prongs



Catalog #	Size, Diameter
RT-084-18	18.5 cm (7 1/4"), Ø 1.8 mm

**Wound Retractor**  
Sharp Prongs, Small Curved



RT-100-01



RT-100-02

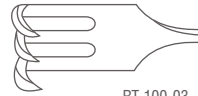

RT-100-03

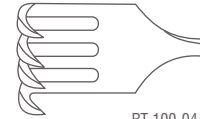

RT-100-04

Catalog #	Size, Width
RT-100-01	16.5 cm (6 1/2")
RT-100-02	16.5 cm (6 1/2"), 4.2 mm
RT-100-03	16.5 cm (6 1/2"), 7.0 mm
RT-100-04	16.5 cm (6 1/2"), 9.5 mm



**Wound Retractor**  
Blunt Prongs, Small Curved



RT-101-01

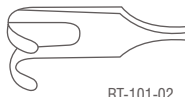

RT-101-02



RT-101-03

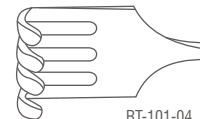

RT-101-04

Catalog #	Size, Width
RT-101-01	16.5 cm (6 1/2")
RT-101-02	16.5 cm (6 1/2"), 4.2 mm
RT-101-03	16.5 cm (6 1/2"), 7.0 mm
RT-101-04	16.5 cm (6 1/2"), 9.5 mm





Hooklets  
Wundhäkchen  
Ganchitos  
Crochetes  
Divaricatori

**Wound Retractor**  
Sharp Flexible Prongs

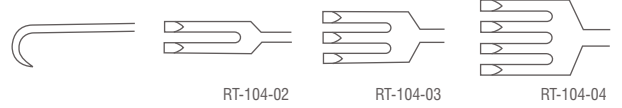

Catalog #	Size
RT-104-02	16 cm (6 1/4")
RT-104-03	16 cm (6 1/4")
RT-104-04	16 cm (6 1/4")



**Wound Retractor**  
Blunt Flexible Prongs

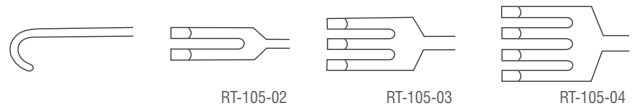

Catalog #	Size
RT-105-02	16 cm (6 1/4")
RT-105-03	16 cm (6 1/4")
RT-105-04	16 cm (6 1/4")



**Wound Retractor**

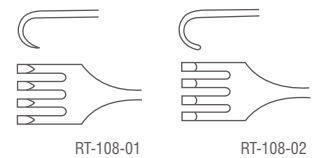

Catalog #	Size, Profile
RT-108-01	16.5 cm (6 1/2"), Sharp
RT-108-02	16.5 cm (6 1/2"), Blunt



**Moldestad Vessel Hook**



Catalog #	Size, Profile
RT-110-12	12 cm (4 3/4")







Saddle Hooks  
Sattelhäkchen  
Ganchos en forma de silla  
Ecarteurs sous forme de selle  
Divaricatori a forma di sella

**Desmarres Lid Retractor**

Catalog #	Size, Blade Width
RT-120-08	16 cm (6 1/4"), 8.0 mm
RT-120-10	16 cm (6 1/4"), 10.0 mm
RT-120-12	16 cm (6 1/4"), 12.0 mm
RT-120-14	16 cm (6 1/4"), 14.0 mm
RT-120-16	16 cm (6 1/4"), 16.0 mm
RT-120-18	16 cm (6 1/4"), 18.0 mm

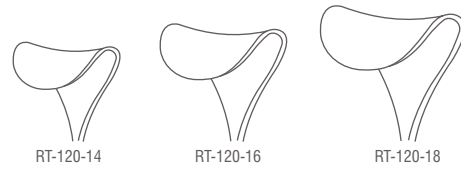

**Lid Retractor**  
Hollow Blade

Catalog #	Size, Blade Width
RT-122-12	16 cm (6 1/4"), 12.0 mm
RT-122-14	16 cm (6 1/4"), 14.0 mm
RT-122-16	16 cm (6 1/4"), 16.0 mm
RT-122-18	16 cm (6 1/4"), 18.0 mm

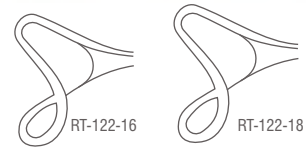
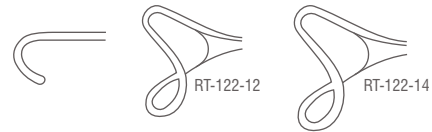

**Masing Lid Retractor**

Catalog #	Size, Blade Width
RT-124-14	14 cm (5 1/2"), 12.0 mm



**Cottle Lid Retractor**

Catalog #	Size, Blade Width
RT-126-14	14 cm (5 1/2"), 12.0 mm





Hooklets  
Wundhäkchen  
Ganchitos  
Crochetes  
Divaricatori

**Mini-Langenbeck Retractor**

Catalog #	Size, Blade Size
RT-130-10	16 cm (6 1/4"), 10 x 6 mm
RT-130-17	16 cm (6 1/4"), 17 x 5 mm
RT-130-20	16 cm (6 1/4"), 20 x 6 mm
RT-130-22	16 cm (6 1/4"), 22 x 8mm

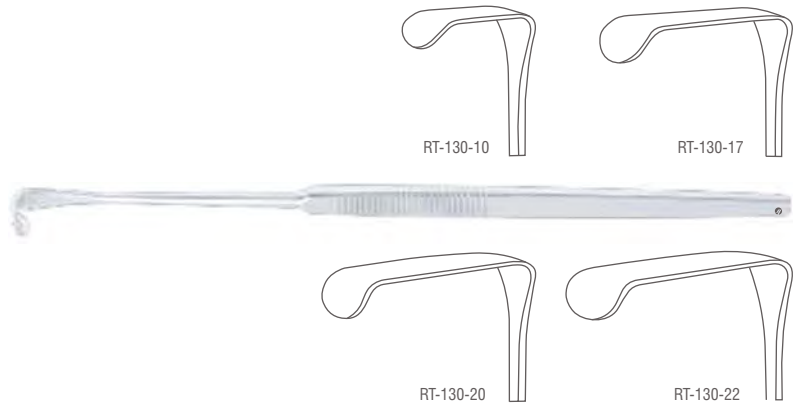

**Langenbeck-Green Retractor**

Catalog #	Size, Blade Size
RT-132-16	16 cm (6 1/4"), 16 x 6 mm
RT-132-24	16 cm (6 1/4"), 24 x 6 mm

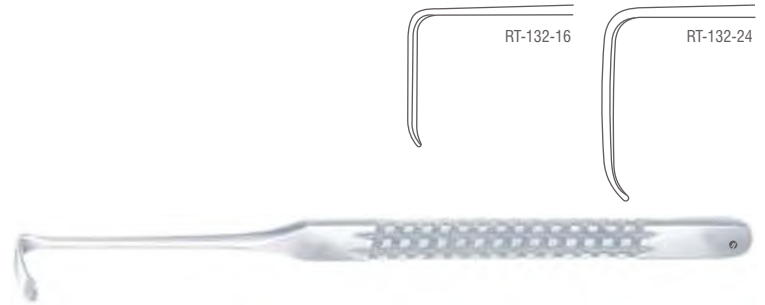

**Wound Retractor**  
Two Blunt Prongs

Catalog #	Size, Blade Size
RT-136-16	16 cm (6 1/4"), 14 x 8 mm



**Wound Retractor**  
Sharp Prongs, Large Curved

Catalog #	Size, Width
RT-140-01	16.5 cm (6 1/2")
RT-140-02	16.5 cm (6 1/2"), 7.5 mm
RT-140-03	16.5 cm (6 1/2"), 10.0 mm
RT-140-04	16.5 cm (6 1/2"), 14.0 mm

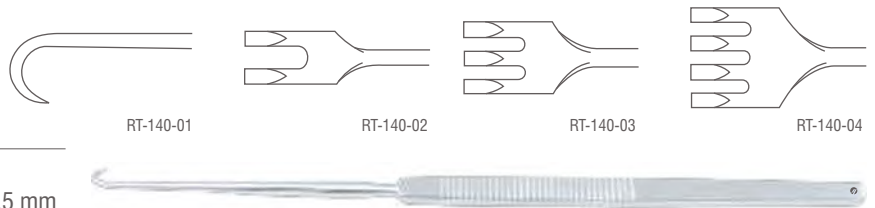



Hooklets  
Wundhäkchen  
Ganchitos  
Crochetes  
Divaricatori

**Wound Retractor**

Blunt Prongs, Large Curved

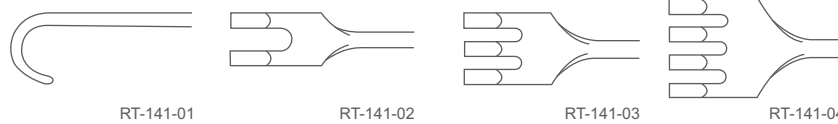

Catalog #	Size, Width
RT-141-01	16.5 cm (6 1/2")
RT-141-02	16.5 cm (6 1/2"), 7.5 mm
RT-141-03	16.5 cm (6 1/2"), 10.0 mm
RT-141-04	16.5 cm (6 1/2"), 14.0 mm



**Meyerding Retractor**



Catalog #	Size, Profile, Blade Size
RT-150-01	17.5 cm (7"), Blunt, 18 x 7 mm
RT-150-02	17.5 cm (7"), Toothed, 16 x 5 mm
RT-150-03	17.5 cm (7"), Toothed, 17 x 4 mm
RT-150-04	17.5 cm (7"), Blunt, 10 x 3 mm
RT-150-05	17.5 cm (7"), Saddle Shaped, 7 x 4 mm
RT-150-06	17.5 cm (7"), 3 Sharp Prongs, 10 x 4 mm

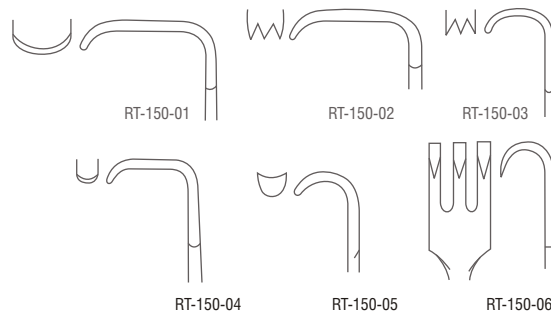

**Senn-Green Retractor**

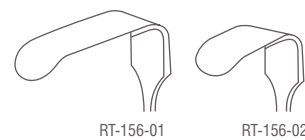

Catalog #	Size, Blade Size, Profile
RT-156-01	15 cm (6"), 20 x 6 mm, Fig. 1
RT-156-02	15 cm (6"), 10 x 6 mm, Fig. 2



**Ragnell-Davis Retractor**

Catalog #	Size, Blade Size
RT-158-14	14 cm (5 1/2"), 8 x 4 mm - 15 x 5.5 mm

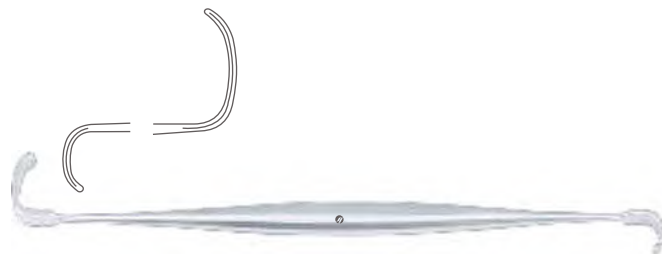



Hooklets, Saddle Hooks  
Wundhäkchen, Sattelhäkchen  
Ganchitos, Ganchos en forma de silla  
Crochetes, Ecarteurs sous forme de selle  
Divaricatori, Divaricatori a forma di sella

**Senn-Miller Retractor  
Sharp**

Catalog #	Size, Blade Size
RT-162-16	16 cm (6 1/4"), 20 x 7 mm



**Senn-Miller Retractor  
Blunt**

Catalog #	Size, Blade Size
RT-163-16	16 cm (6 1/4"), 20 x 7 mm



**Cushing Retractor/Saddle Hook**

Catalog #	Size
RT-170-20	20.5 cm (8")

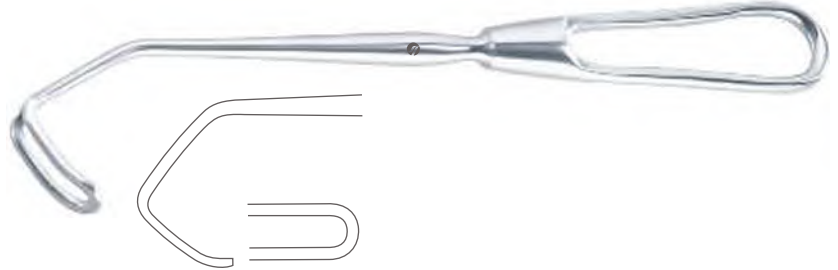

**Cushing Retractor/Saddle Hook**

Catalog #	Size, Blade Size
RT-172-08	20.5 cm (8"), 8.0 mm
RT-172-10	20.5 cm (8"), 10.0 mm
RT-172-12	20.5 cm (8"), 12.0 mm
RT-172-14	20.5 cm (8"), 14.0 mm
RT-172-16	20.5 cm (8"), 16.0 mm
RT-172-18	20.5 cm (8"), 18.0 mm

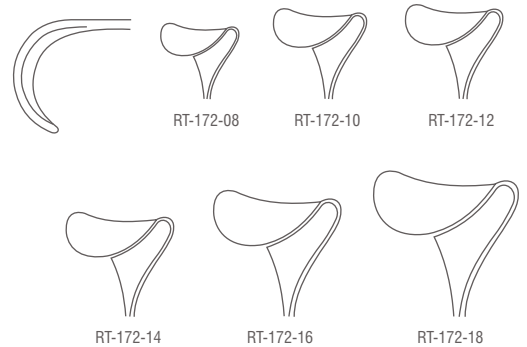



Saddle Hooks, Vein Hooks  
Sattelhäkchen, Venenhäkchen, Wundhäkchen  
Ganchos en forma de silla, Ganchitos para venas  
Ecarteurs sous forme de selle, Ecarteurs pour veines  
Divaricatori a forma di sella, Divaricatori per veni

**Cushing Retractor/Saddle Hook**

Catalog #	Size, Blade Size
RT-174-08	24 cm (9 1/2"), 8.0 mm
RT-174-10	24 cm (9 1/2"), 10.0 mm
RT-174-12	24 cm (9 1/2"), 12.0 mm
RT-174-14	24 cm (9 1/2"), 14.0 mm
RT-174-16	24 cm (9 1/2"), 16.0 mm
RT-174-18	24 cm (9 1/2"), 18.0 mm

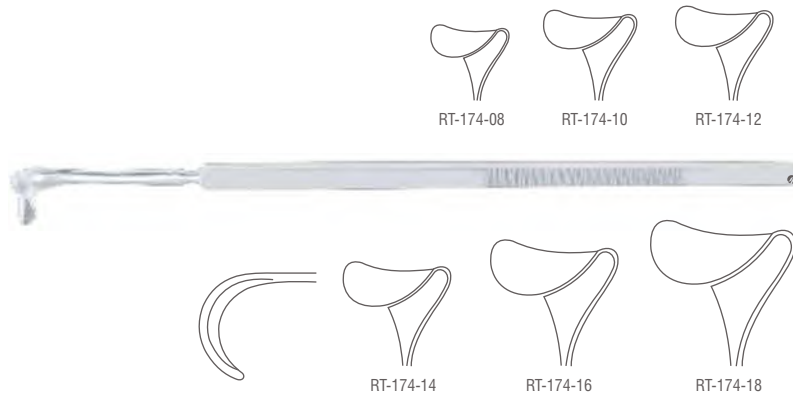

**Gil-Vernet Retractor/Saddle Hook**

Catalog #	Size, Blade Size
RT-176-08	24 cm (9 1/2"), 8.0 mm
RT-176-11	24 cm (9 1/2"), 11.0 mm
RT-176-15	24 cm (9 1/2"), 15.0 mm
RT-176-17	24 cm (9 1/2"), 17.0 mm
RT-176-20	24 cm (9 1/2"), 20.0 mm
RT-176-23	24 cm (9 1/2"), 23.0 mm

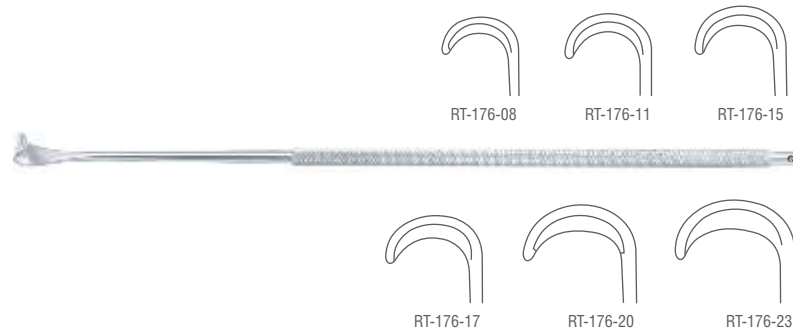

**Brom Vein Hook**

Catalog #	Size
RT-178-01	19.5 cm (7 3/4")
RT-178-02	19.5 cm (7 3/4")



**Strandell-Stille Retractor**

Catalog #	Size, Profile
RT-180-01	19 cm (7 3/4"), Smooth
RT-180-02	19 cm (7 3/4"), Toothed

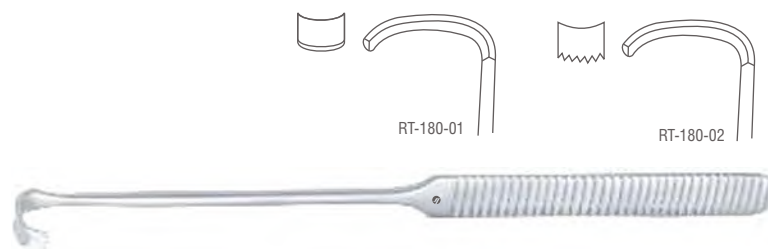



Retractors  
Wundhaken, Wundhäkchen  
Separadores  
Ecarteurs  
Divaricatori

**Kaye-Millard Retractor**  
Sharp



Catalog #	Size
RT-184-08	8 cm (3")

**Klapp Retractor**  
Blunt

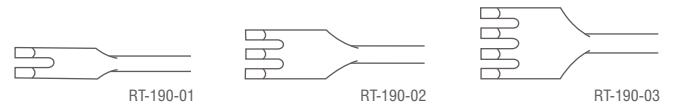

Catalog #	Size, Blade Size, Profile
RT-190-01	17.5 cm (7"), 13 x 6 mm, 2 Prongs
RT-190-02	17.5 cm (7")s, 12 x 11 mm, 3 Prong
RT-190-03	17.5 cm (7"), 15 x 11 mm, 4 Prongs



**Wound Retractor**  
Sharp, 4 Prongs

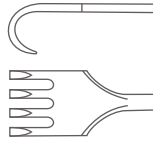

Catalog #	Size
RT-192-04	16.5 cm (6 1/2")



**Wound Retractor**  
Blunt, 4 Prongs

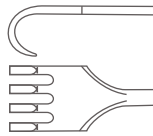

Catalog #	Size
RT-193-04	16.5 cm (6 1/2")



**Volkman Retractor**  
Sharp, Hollow Handle

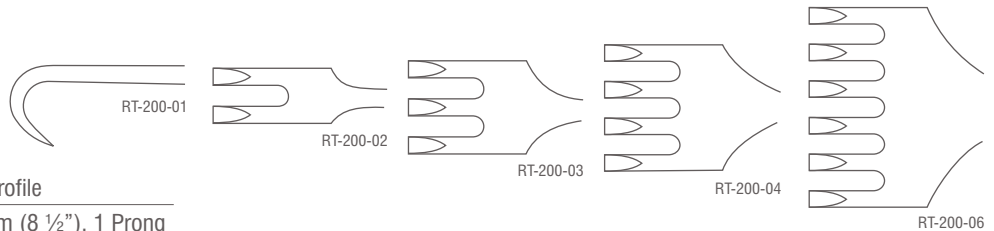

Catalog #	Size, Profile
RT-200-01	21.5 cm (8 1/2"), 1 Prong
RT-200-02	21.5 cm (8 1/2"), 2 Prongs
RT-200-03	21.5 cm (8 1/2"), 3 Prongs
RT-200-04	21.5 cm (8 1/2"), 4 Prongs
RT-200-06	21.5 cm (8 1/2"), 6 Prongs





Retractors  
Wundhaken, Wundhäkchen  
Separadores  
Ecarteurs  
Divaricatori

**Volkman Retractor**  
Blunt, Hollow Handle

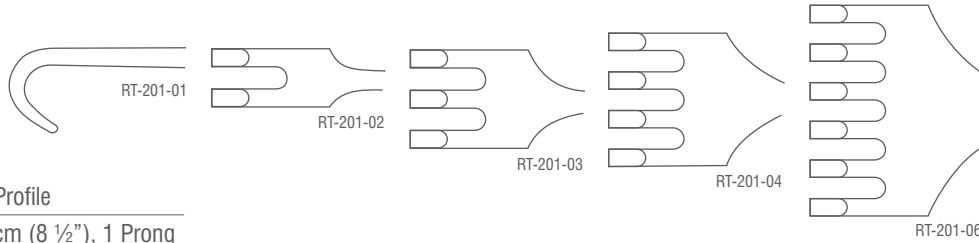

Catalog #	Size, Profile
RT-201-01	21.5 cm (8 1/2"), 1 Prong
RT-201-02	21.5 cm (8 1/2"), 2 Prongs
RT-201-03	21.5 cm (8 1/2"), 3 Prongs
RT-201-04	21.5 cm (8 1/2"), 4 Prongs
RT-201-06	21.5 cm (8 1/2"), 6 Prongs



**Volkman Retractor**  
Sharp

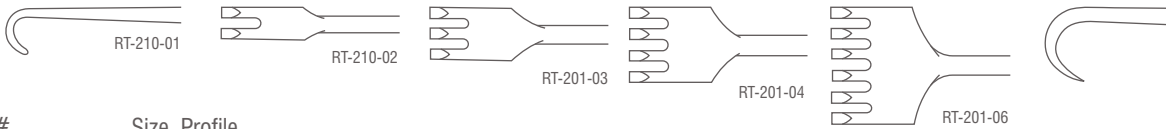

Catalog #	Size, Profile
RT-210-01	22 cm (8 3/4"), 1 Prong
RT-210-02	22 cm (8 3/4"), 2 Prongs
RT-210-03	22 cm (8 3/4"), 3 Prongs
RT-210-04	22 cm (8 3/4"), 4 Prongs
RT-210-06	22 cm (8 3/4"), 6 Prongs



**Volkman Retractor**  
Blunt

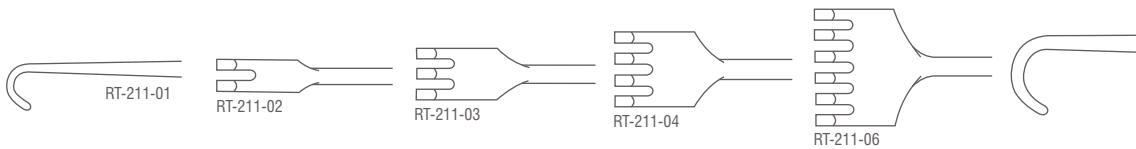

Catalog #	Size, Profile
RT-211-01	22 cm (8 3/4"), 1 Prong
RT-211-02	22 cm (8 3/4"), 2 Prongs
RT-211-03	22 cm (8 3/4"), 3 Prongs
RT-211-04	22 cm (8 3/4"), 4 Prongs
RT-211-06	22 cm (8 3/4"), 6 Prongs





Retractors  
Wundhaken, Wundhäkchen  
Separadores  
Ecarteurs  
Divaricatori

**Volkman Retractor**  
Semi Sharp

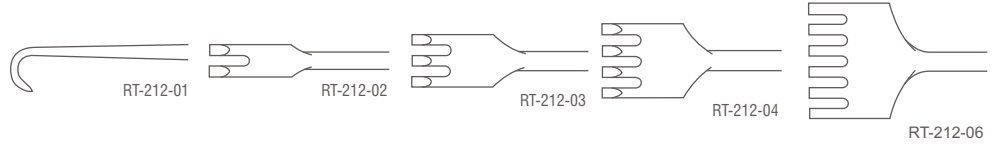

Catalog #	Size, Profile
RT-212-01	22 cm (8 3/4"), 1 Prong
RT-212-02	22 cm (8 3/4"), 2 Prongs
RT-212-03	22 cm (8 3/4"), 3 Prongs
RT-212-04	22 cm (8 3/4"), 4 Prongs
RT-212-06	22 cm (8 3/4"), 6 Prongs



**Volkman Retractor**  
Sharp, 1 Prong

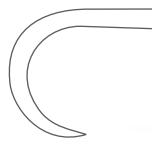

Catalog #	Size
RT-214-01	21.5 cm (8 1/2")



**Volkman Retractor**  
Blunt, 1 Prong

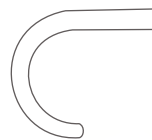

Catalog #	Size, Profile
RT-215-01	21.5 cm (8 1/2")



**Volkman Retractor**  
Sharp, 1 Prong



Catalog #	Size, Profile
RT-218-01	21.5 cm (8 1/2")







Retractors  
Wundhaken, Wundhäkchen  
Separadores  
Ecarteurs  
Divaricatori

**Kocher Retractor  
Sharp**

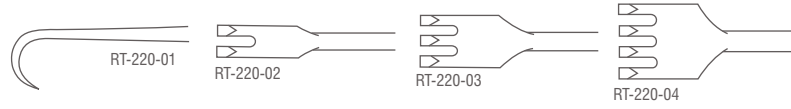

Catalog #	Size, Profile
RT-220-01	22 cm (8 3/4"), 1 Prong
RT-220-02	22 cm (8 3/4"), 2 Prongs
RT-220-03	22 cm (8 3/4"), 3 Prongs
RT-220-04	22 cm (8 3/4"), 4 Prongs
RT-220-06	22 cm (8 3/4"), 6 Prongs
RT-220-08	22 cm (8 3/4"), 8 Prongs

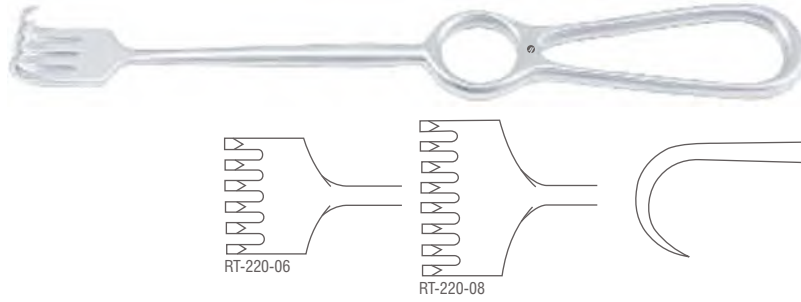

**Kocher Retractor  
Blunt**



Catalog #	Size, Profile
RT-221-01	22 cm (8 3/4"), 1 Prong
RT-221-02	22 cm (8 3/4"), 2 Prongs
RT-221-03	22 cm (8 3/4"), 3 Prongs
RT-221-04	22 cm (8 3/4"), 4 Prongs
RT-221-06	22 cm (8 3/4"), 6 Prongs
RT-221-08	22 cm (8 3/4"), 8 Prongs

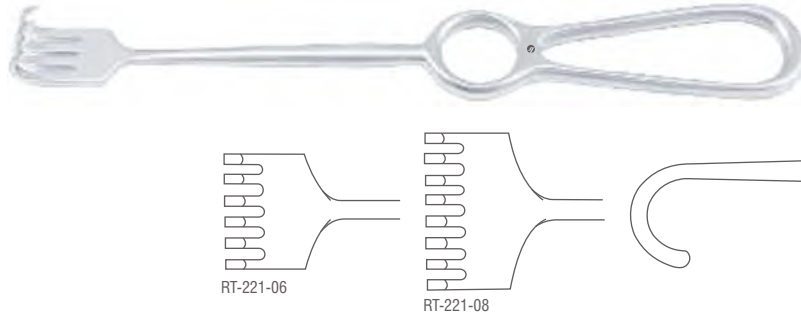

**Kocher Retractor  
Semi Sharp**



Catalog #	Size, Profile
RT-222-01	22 cm (8 3/4"), 1 Prong
RT-222-02	22 cm (8 3/4"), 2 Prongs
RT-222-03	22 cm (8 3/4"), 3 Prongs
RT-222-04	22 cm (8 3/4"), 4 Prongs
RT-222-06	22 cm (8 3/4"), 6 Prongs
RT-222-08	22 cm (8 3/4"), 8 Prongs

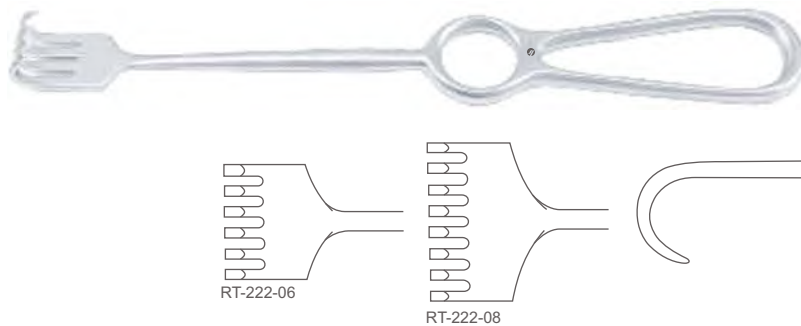



Retractors  
Wundhaken, Wundhäkchen  
Separadores  
Ecarteurs  
Divaricatori

**Murphy Retractor Sharp**

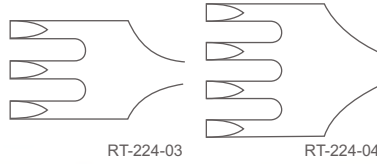

Catalog #	Size, Profile
RT-224-03	19.5 cm (7 3/4"), 3 Prongs
RT-224-04	19.5 cm (7 3/4"), 4 Prongs

**Murphy Retractor Blunt**

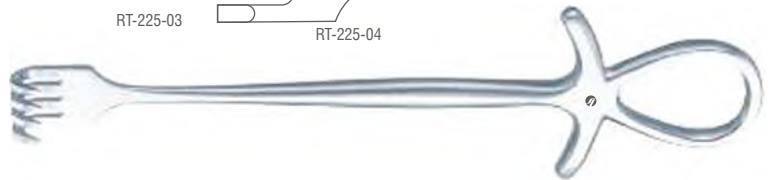
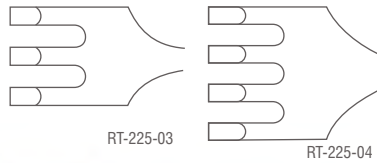

Catalog #	Size, Profile
RT-225-03	19.5 cm (7 3/4"), 3 Prongs
RT-225-04	19.5 cm (7 3/4"), 4 Prongs

**Ollier Retractor Blunt**

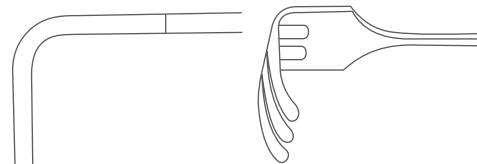

Catalog #	Size, Blade Size, Profile
RT-231-03	23 cm (9"), 36 x 30 mm, 3 Prongs
RT-231-04	23 cm (9"), 36 x 60 mm, 4 Prongs

**Wassmund Retractor**

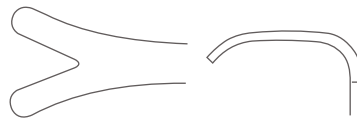

Catalog #	Size, Blade Size
RT-235-02	20.5 cm (8"), 33 x 21 mm

**Koerte Retractor Sharp, 8 Prongs**

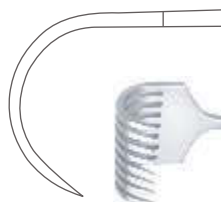

Catalog #	Size, Blade Size
RT-238-08	24.5 cm (9 3/4"), 40 x 30 mm



Retractors  
Wundhaken, Wundhäkchen  
Separadores  
Ecarteurs  
Divaricatori

**Koerte Retractor**  
Blunt, 8 Prongs



Catalog #	Size, Blade Size
RT-239-08	24.5 cm (9 3/4"), 40 x 30 mm

**Israel Retractor**  
Blunt, 4 prongs



Catalog #	Size, Blade Size, Profile
RT-241-04	25.5 cm (10"), 40 x 40 mm, Blunt, 4 Prongs
RT-243-05	25.5 cm (10"), 45 x 50 mm, Blunt, 5 Prongs
RT-245-06	25.5 cm (10"), 50 x 60 mm, Blunt, 6 Prongs
RT-247-07	25.5 cm (10"), 70 x 70 mm, Blunt, 7 Prongs

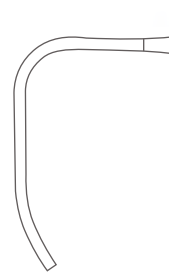

RT-241-04

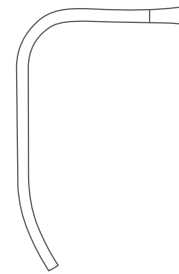

RT-243-05

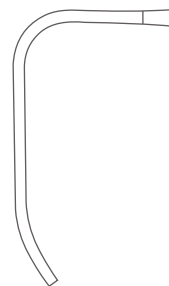

RT-245-06

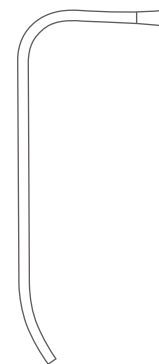

RT-247-07



Retractors  
Wundhaken, Wundhäkchen  
Separadores  
Ecarteurs  
Divaricatori

**Langenbeck Retractor**

Catalog #	Size, Blade Size
RT-251-01	22.5 cm (8 3/4"), 30 x 11 mm
RT-251-02	22.5 cm (8 3/4"), 30 x 14 mm
RT-251-03	22.5 cm (8 3/4"), 30 x 16 mm
RT-251-04	22.5 cm (8 3/4"), 40 x 11 mm
RT-251-05	22.5 cm (8 3/4"), 50 x 11 mm

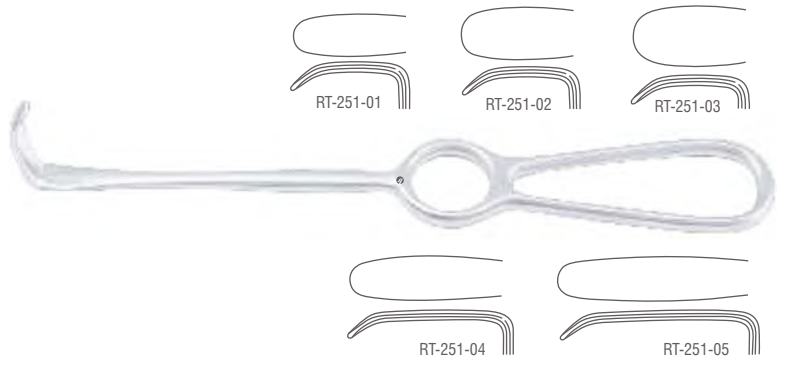

**Langenbeck Retractor  
Hollow Handle**

Catalog #	Size, Blade Size
RT-253-01	22.5 cm (8 3/4"), 30 x 11 mm
RT-253-02	22.5 cm (8 3/4"), 30 x 14 mm
RT-253-03	22.5 cm (8 3/4"), 30 x 16 mm
RT-253-04	22.5 cm (8 3/4"), 40 x 11 mm
RT-253-05	22.5 cm (8 3/4"), 50 x 11 mm

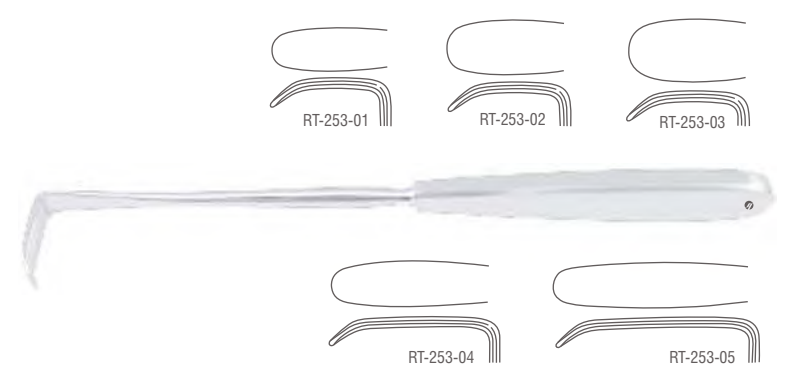

**Langenbeck Retractor**

Catalog #	Size, Blade Size
RT-255-00	22.5 cm (8 3/4"), 33 x 14 mm



**Langenbeck Retractor**

Catalog #	Size, Blade Size
RT-257-01	21 cm (8 1/4"), 55 x 20 mm
RT-257-02	21 cm (8 1/4"), 60 x 20 mm
RT-257-03	21 cm (8 1/4"), 63 x 20 mm





Retractors  
Wundhaken, Wundhäkchen  
Separadores  
Ecarteurs  
Divaricatori

**Langenbeck Retractor**

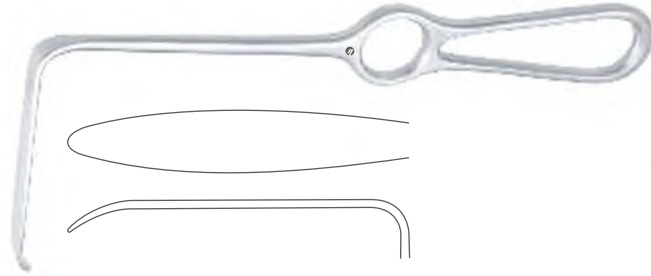

Catalog #	Size, Blade Size
RT-259-22	22.5 cm (8 3/4"), 85 x 15 mm

**Lahey Retractor**

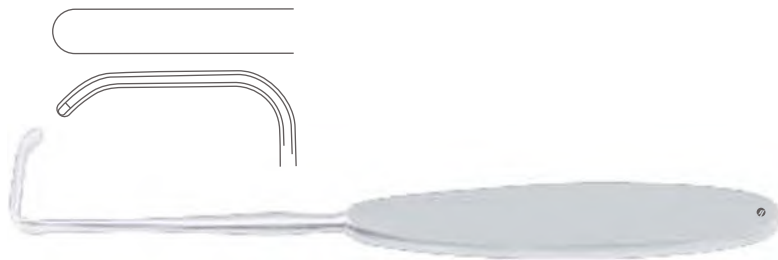

Catalog #	Size, Blade Size
RT-271-19	19.5 cm (7 3/4"), 31 x 6 mm

**Little Retractor**



Catalog #	Size, Blade Size
RT-275-20	20 cm (8"), 13 x 15 mm

**Kocher Retractor**

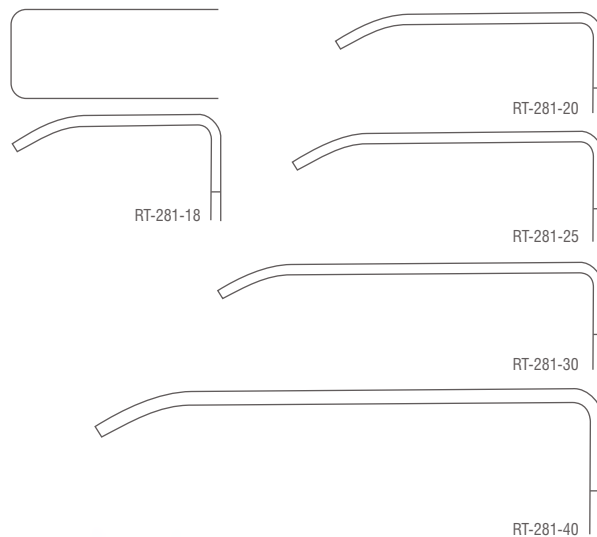

Catalog #	Size, Blade Size
RT-281-18	23 cm (9"), 41 x 18 mm
RT-281-20	23 cm (9"), 61 x 20 mm
RT-281-25	23 cm (9"), 61 x 25 mm
RT-281-30	23 cm (9"), 75 x 30 mm
RT-281-40	23 cm (9"), 75 x 40 mm





Retractors  
Wundhaken, Wundhäkchen  
Separadores  
Ecarteurs  
Divaricatori

**Kocher-Langenbeck Retractor**

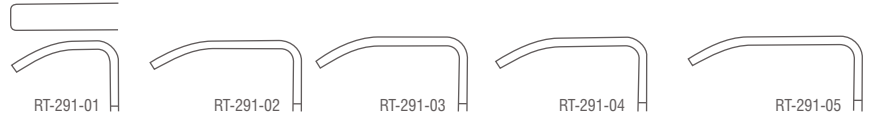

Catalog #	Size, Blade Size
RT-291-01	21.5 cm (8 1/2"), 25 x 6 mm
RT-291-02	21.5 cm (8 1/2"), 35 x 8 mm
RT-291-03	21.5 cm (8 1/2"), 35 x 11 mm
RT-291-04	21.5 cm (8 1/2"), 35 x 15 mm
RT-291-05	21.5 cm (8 1/2"), 40 x 11 mm
RT-291-06	21.5 cm (8 1/2"), 55 x 11 mm
RT-291-07	21.5 cm (8 1/2"), 70 x 14 mm
RT-291-08	21.5 cm (8 1/2"), 80 x 12 mm
RT-291-09	21.5 cm (8 1/2"), 80 x 16 mm

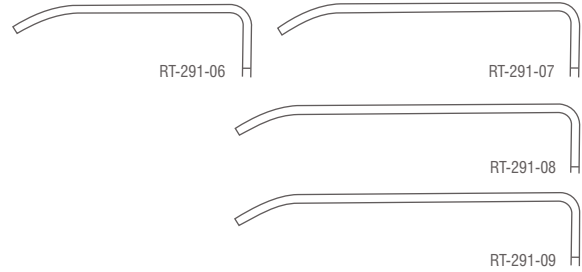

**Kocher-Langenbeck Retractor**

Catalog #	Size, Blade Size
RT-293-01	21.5 cm (8 1/2"), 25 x 10 mm
RT-293-02	21.5 cm (8 1/2"), 40 x 13 mm
RT-293-03	21.5 cm (8 1/2"), 60 x 13 mm
RT-293-04	21.5 cm (8 1/2"), 40 x 18 mm
RT-293-05	21.5 cm (8 1/2"), 60 x 18 mm
RT-293-06	21.5 cm (8 1/2"), 85 x 18 mm
RT-293-07	21.5 cm (8 1/2"), 60 x 25 mm
RT-293-08	21.5 cm (8 1/2"), 85 x 25 mm

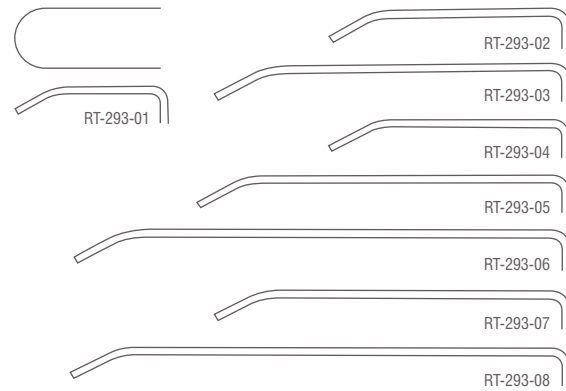

**Sauerbruch Retractor**

Catalog #	Size, Blade Size
RT-295-01	22.5 cm (8 3/4"), 45 x 15 mm
RT-295-02	22.5 cm (8 3/4"), 60 x 23 mm
RT-295-03	22.5 cm (8 3/4"), 72 x 20 mm

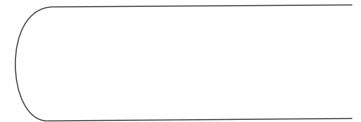



Retractors  
Wundhaken, Wundhäkchen  
Separadores  
Ecarteurs  
Divaricatori

**Kirsch Retractor**

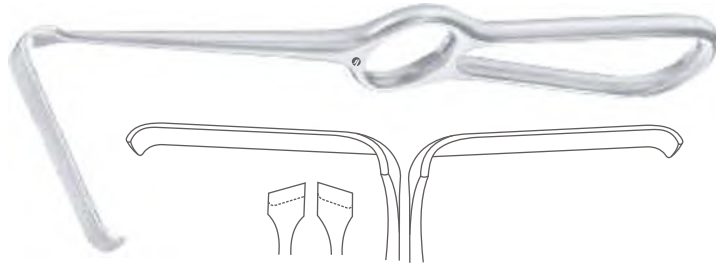

Catalog #	Size, Blade Size, Profile
RT-297-01	21 cm (8 1/4"), 60 x 11 mm, Left
RT-297-02	21 cm (8 1/4"), 60 x 11 mm, Right

**Zenker Retractor**

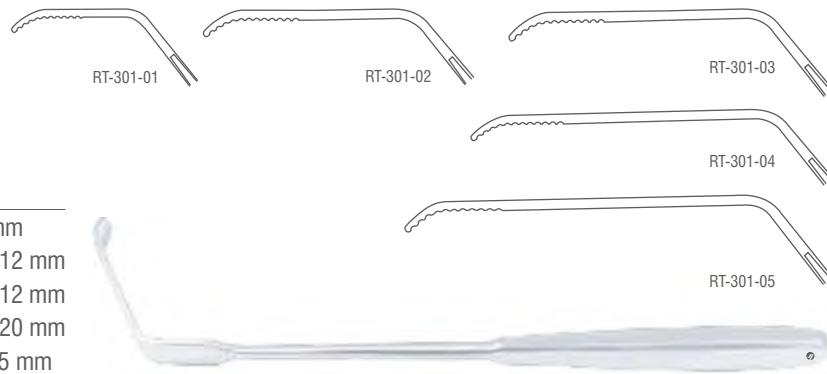

Catalog #	Size, Blade Size
RT-301-01	25 cm (9 3/4"), 35 x 8 mm
RT-301-02	26.5 cm (10 1/2"), 60 x 12 mm
RT-301-03	27.5 cm (10 3/4"), 75 x 12 mm
RT-301-04	28.5 cm (11 1/4"), 85 x 20 mm
RT-301-05	30.5 cm (12"), 100 x 25 mm

**Koenig Retractor**



Catalog #	Size, Blade Size
RT-305-01	18 cm (7"), 13 x 13 mm
RT-305-02	18 cm (7"), 12 x 16 mm

**Cushing-Kocher Retractor**



Catalog #	Size, Blade Size
RT-305-17	17.5 cm (7"), 10 x 10 mm



Retractors  
Wundhaken, Wundhäkchen  
Separadores  
Ecarteurs  
Divaricatori

**Kocher Retractor**

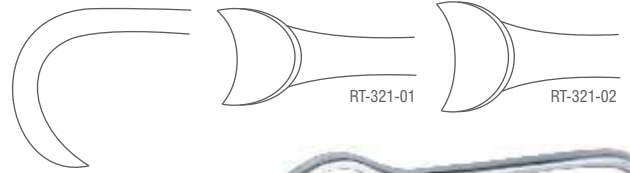

Catalog #	Size, Blade Size
RT-321-01	21.5 cm (8 1/2"), 22 x 12 mm
RT-321-02	21.5 cm (8 1/2"), 24 x 14 mm



**Kocher Retractor**

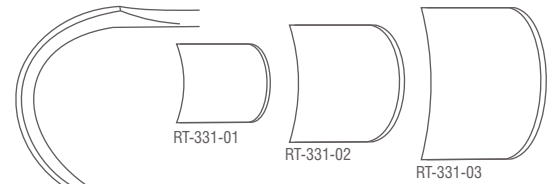

Catalog #	Size, Blade Size
RT-331-01	22 cm (8 1/2"), 42 x 10 mm
RT-331-02	23 cm (9"), 42 x 15 mm
RT-331-03	23 cm (9"), 43 x 20 mm



**Schoenborn Retractor**



Catalog #	Size, Blade Size
RT-335-20	20 cm (8"), 13 x 6 mm

**Wound Retractor**  
Double Ended



Catalog #	Size, Blade Size
RT-337-20	20.5 cm (8"), 20 x 19 mm

**Dissecting Hook**  
For Longitudinal Dissection of Vessels

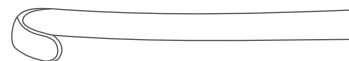

Catalog #	Size
RT-341-23	23.5 cm (9 1/2")







Retractors  
Wundhaken, Wundhäkchen  
Separadores  
Ecarteurs  
Divaricatori

**Durham Retractor**



Catalog #	Size, Blade Size
RT-351-21	21.5 cm (8 1/2"), 16 x 25 mm

**Middeldorf Retractor**

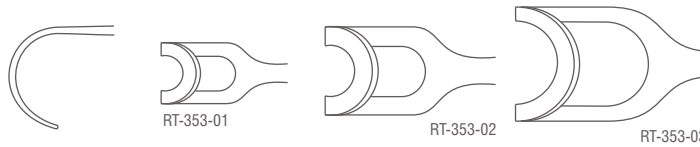

Catalog #	Size, Blade Size
RT-353-01	21.5 cm (8 1/2"), 15 x 17 mm
RT-353-02	23 cm (9"), 22 x 22 mm
RT-353-03	24.5 cm (9 3/4"), 26 x 31 mm



**Middeldorf Retractor**

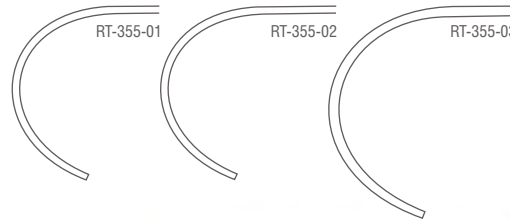

Catalog #	Size, Blade Size
RT-355-01	27 cm (10 3/4"), 48 x 45 mm
RT-355-02	27 cm (10 3/4"), 52 x 50 mm
RT-355-03	28 cm (11"), 60 x 70 mm



**Greene Retractor**

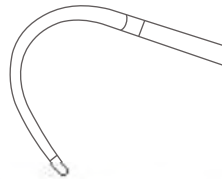

Catalog #	Size, Blade Size
RT-357-22	22.5 cm (8 3/4"), 22 x 22 mm



**Buchs Retractor**



Catalog #	Size, Blade Size
RT-361-20	20.5 cm (8"), 38 x 18 mm



Retractors  
Wundhaken, Wundhäkchen  
Separadores  
Ecarteurs  
Divaricatori

**Kraemer Retractor**



Catalog #	Size, Blade Size
RT-363-21	21 cm (8 1/4"), 66 x 10 mm

**Caspar Retractor**



Catalog #	Size, Blade Size
RT-365-21	21 cm (8 1/4"), 67 x 17 mm

**Dockhorn Retractor**



Catalog #	Size, Blade Size
RT-367-01	21 cm (8 1/4"), 40 x 12 mm
RT-367-02	21 cm (8 1/4"), 55 x 14 mm

**Martin Retractor**

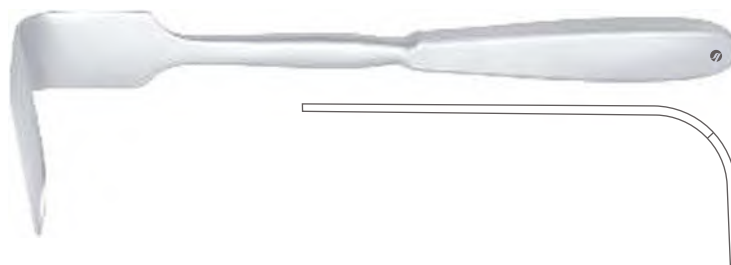

Catalog #	Size, Blade Size
RT-371-25	26 cm (10 1/4"), 110 x 27 mm

**Simon Retractor**

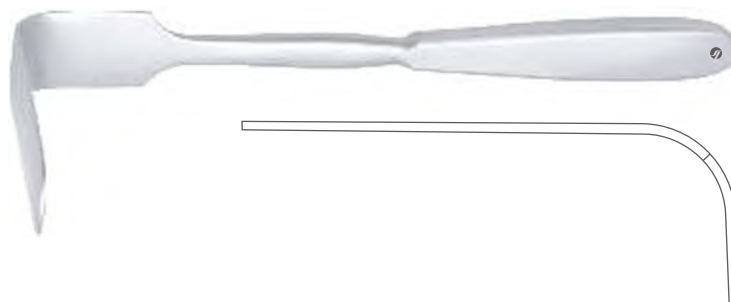

Catalog #	Size, Blade Size
RT-373-01	28 cm (11"), 115 x 22 mm
RT-373-02	28 cm (11"), 115 x 27 mm



Retractors  
Wundhaken, Wundhäkchen  
Separadores  
Ecarteurs  
Divaricatori

**Brunner Retractor**

Catalog #	Size, Blade Size
RT-375-08	25.5 cm (10"), 84 x 20 mm
RT-375-10	25.5 cm (10"), 104 x 25 mm
RT-375-12	25.5 cm (10"), 124 x 30 mm
RT-375-13	25.5 cm (10"), 130 x 30 mm
RT-375-14	25.5 cm (10"), 144 x 30 mm
RT-375-16	25.5 cm (10"), 160 x 30 mm
RT-375-18	25.5 cm (10"), 164 x 30 mm

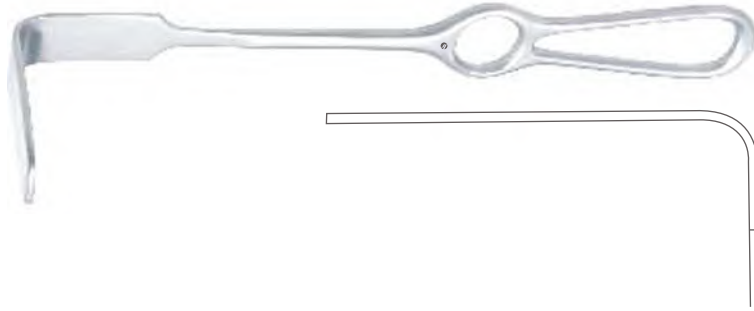

**Brunner Retractor**

Catalog #	Size, Blade Size
RT-377-08	25.5 cm (10"), 82 x 20 mm
RT-377-10	25.5 cm (10"), 102 x 20 mm
RT-377-12	25.5 cm (10"), 122 x 30 mm
RT-377-14	25.5 cm (10"), 140 x 25 mm
RT-377-16	25.5 cm (10"), 162 x 30 mm
RT-377-18	25.5 cm (10"), 182 x 30 mm

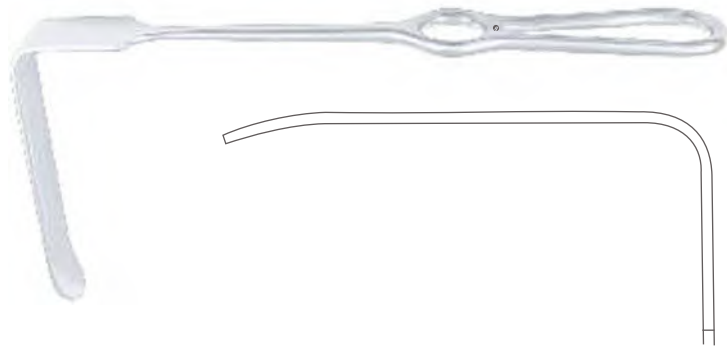

**Coryllos Retractor**

Catalog #	Size, Blade Size
RT-381-01	24 cm (9 1/2"), 85 x 22 mm
RT-381-02	24 cm (9 1/2"), 108 x 43 mm
RT-381-03	24 cm (9 1/2"), 119 x 65 mm

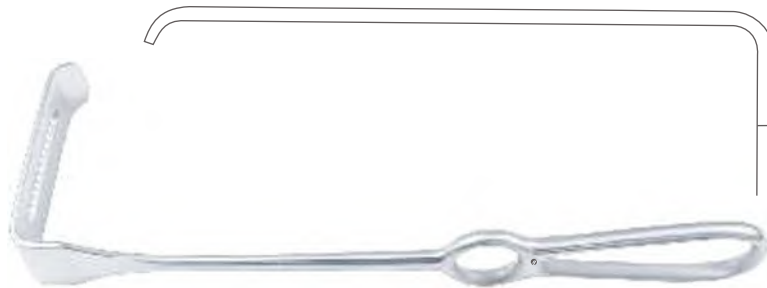

**Davidson Scapula Retractor**

Catalog #	Size, Blade Size
RT-385-01	19 cm (7 1/2"), 80 x 54 mm
RT-385-02	18.5 cm (7 1/4"), 80 x 95 mm





Retractors  
Wundhaken, Wundhäkchen  
Separadores  
Ecarteurs  
Divaricatori

**Sauerbruch Retractor**

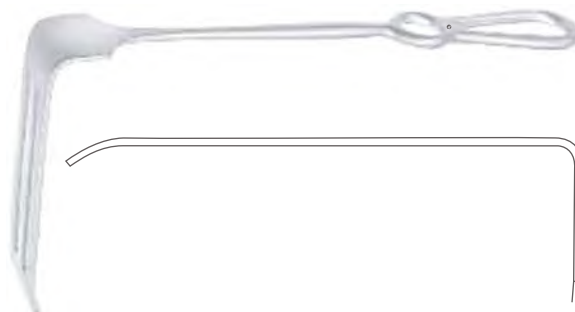

Catalog #	Size, Blade Size
RT-387-25	25.5 cm (10"), 127 x 38 mm

**Richardson-Eastman Retractor**



Catalog #	Size, Blade Size, Profile
RT-400-00	Set of Fig.1 & Fig. 2
RT-400-01	26 cm (10 1/4"), 28 x 20 mm-36 x 28 mm, Fig. 1
RT-400-02	27 cm (10 3/4"), 49 x 38 mm-63 x 49 mm, Fig. 2

**Richardson Retractor**



Catalog #	Size, Blade Size
RT-403-01	23.5 cm (9 1/4"), 25 x 21 mm
RT-403-02	24 cm (9 1/2"), 30 x 29 mm
RT-403-03	24 cm (9 1/2"), 38 x 40 mm

**Richardson Retractor**



Catalog #	Size, Blade Size
RT-405-24	24 cm (9 1/2"), 48 x 22 mm



Retractors  
Wundhaken, Wundhäkchen  
Separadores  
Ecarteurs  
Divaricatori

**Kelly Retractor**

Catalog #	Size, Blade Size
RT-409-01	26 cm (10 1/4"), 50 x 40 mm
RT-409-02	26 cm (10 1/4"), 62 x 50 mm
RT-409-03	26 cm (10 1/4"), 70 x 65 mm
RT-409-04	26 cm (10 1/4"), 90 x 76 mm



**Tuffier Retractor**

Catalog #	Size, Blade Size
RT-413-21	21.5 cm (8 1/2"), 58 x 64 mm



**Morris Retractor**

Catalog #	Size, Blade Size
RT-415-01	24.5 cm (9 3/4"), 70 x 40 mm
RT-415-02	24.5 cm (9 3/4"), 70 x 50 mm
RT-415-03	24.5 cm (9 3/4"), 70 x 65 mm



**Tudor-Edwards Retractor**

Catalog #	Size, Blade Size
RT-417-20	20.5 cm (8"), 55 x 47 mm





Retractors  
Wundhaken, Wundhäkchen  
Separadores  
Ecarteurs  
Divaricatori

**Meyering Retractor**

Catalog #	Size, Blade Size
RT-419-01	23 cm (9"), 52 x 16 mm
RT-419-02	23 cm (9"), 76 x 25 mm
RT-419-03	25.5 cm (10"), 89 x 50 mm



**Doyen Retractor**

Catalog #	Size, Blade Size
RT-423-01	24 cm (9 1/2"), 45 x 88 mm
RT-423-02	25 cm (9 3/4"), 53 x 80 mm
RT-423-03	25 cm (9 3/4"), 78 x 82 mm



**Doyen Retractor**

Catalog #	Size, Blade Size
RT-431-01	28 cm (11"), 48 x 90 mm
RT-431-02	28 cm (11"), 48 x 105 mm
RT-431-03	28 cm (11"), 48 x 120 mm
RT-431-04	28 cm (11"), 48 x 135 mm



**Chain With Weight**

For Use with RT-431-01 to 431-04

Catalog #	Size
RT-431-10	79 cm (31")





Retractors  
Wundhaken, Wundhäkchen  
Separadores  
Ecarteurs  
Divaricatori

**Kocher Retractor**



Catalog #	Size, Blade Size
RT-435-22	24 cm (9 1/2"), 73 x 25 mm

**Kocher Retractor**



Catalog #	Size, Blade Size
RT-437-01	25 cm (9 3/4"), 80 x 45 mm
RT-437-02	25 cm (9 3/4"), 80 x 55 mm
RT-437-03	25 cm (9 3/4"), 80 x 65 mm

**Doyen-Stille Retractor**

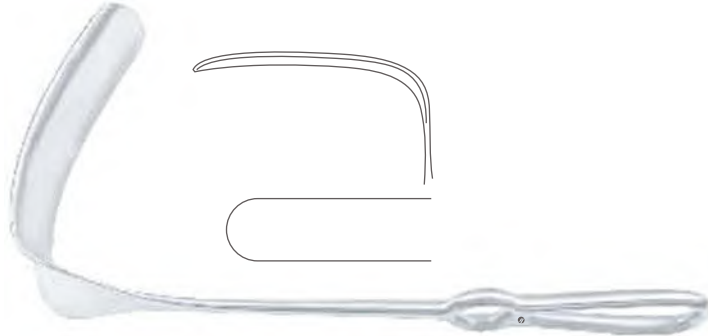

Catalog #	Size, Blade Size
RT-441-01	26 cm (10 1/4"), 87 x 28 mm
RT-441-02	26 cm (10 1/4"), 97 x 31 mm
RT-441-03	26 cm (10 1/4"), 117 x 52 mm

**Fritsch Retractor**



Catalog #	Size, Blade Size
RT-445-01	23.5 cm (9 1/4"), 37 x 31 mm
RT-445-02	24 cm (9 1/2"), 38 x 40 mm
RT-445-03	25 cm (9 3/4"), 43 x 51 mm
RT-445-04	25 cm (9 3/4"), 49 x 61 mm
RT-445-05	25.5 cm (10"), 48 x 75 mm
RT-445-06	26.5 cm (10 1/2"), 65 x 85 mm



Retractors  
Wundhaken, Wundhäkchen  
Separadores  
Ecarteurs  
Divaricatori

**Hoesel Retractor**

Catalog #	Size, Blade Size
RT-449-01	26 cm (10 1/4"), 63 x 21 mm
RT-449-02	26 cm (10 1/4"), 83 x 30 mm
RT-449-03	26 cm (10 1/4"), 103 x 30 mm
RT-449-04	26 cm (10 1/4"), 120 x 30 mm
RT-449-05	26 cm (10 1/4"), 140 x 30 mm
RT-449-06	26 cm (10 1/4"), 140 x 40 mm

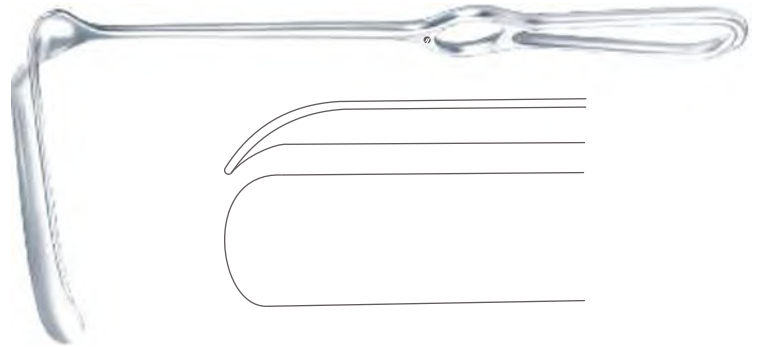

**Ross Aorta Retractor**  
Flexible Shaft

Catalog #	Size, Profile
RT-455-01	25.5 cm (10"), Fig. 1
RT-455-02	25.5 cm (10"), Fig. 2
RT-455-03	25.5 cm (10"), Fig. 3
RT-455-04	25.5 cm (10"), Fig. 4
RT-455-05	25.5 cm (10"), Fig. 5
RT-455-06	25.5 cm (10"), Fig. 6



**Polloson Retractor**

Catalog #	Size
RT-459-27	29 cm (11 1/2")



**Polloson Retractor**

Catalog #	Size
RT-461-27	25.5 cm (10")







Retractors  
Wundhaken, Wundhäkchen  
Separadores  
Ecarteurs  
Divaricatori

**Harrington Retractor**

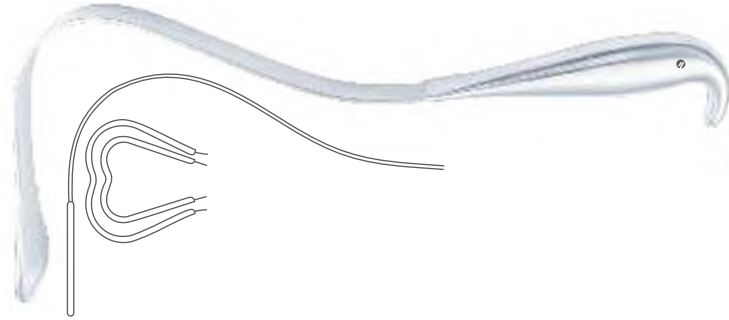

Catalog #	Size, Blade Size
RT-465-01	31.5 cm (12 1/2"), 137 x 44 mm
RT-465-02	33 cm (13"), 137 x 65 mm

**Deaver Retractor**

Fig. 1



Catalog #	Size, Blade Width
RT-471-01	18 cm (7"), 19 mm

**Deaver Retractor**

Fig. 2



Catalog #	Size, Blade Width
RT-471-02	21.5 cm (8 1/2"), 22 mm

**Deaver Retractor**

Fig. 3



Catalog #	Size, Blade Width
RT-471-03	25 cm (9 3/4"), 25 mm

**Deaver Retractor**

Fig. 4



Catalog #	Size, Blade Width
RT-471-04	31 cm (12 1/4"), 25 mm



Retractors  
Wundhaken, Wundhäkchen  
Separadores  
Ecarteurs  
Divaricatori

**Deaver Retractor**  
Fig. 5



Catalog #	Size, Blade Width
RT-471-05	33 cm (13"), 25 mm

**Deaver Retractor**  
Fig. 6



Catalog #	Size, Blade Width
RT-471-06	36 cm (14 1/4"), 25 mm

**Deaver Retractor**  
Fig. 7



Catalog #	Size, Blade Width
RT-471-07	30 cm (11 3/4"), 38 mm

**Deaver Retractor**  
Fig. 8



Catalog #	Size, Blade Width
RT-471-08	31 cm (12 1/4"), 50 mm

**Deaver Retractor**  
Fig. 9



Catalog #	Size, Blade Width
RT-471-09	31.5 cm (12 1/2"), 75 mm



Retractors  
Wundhaken, Wundhäkchen  
Separadores  
Ecarteurs  
Divaricatori

**Deaver Retractor**  
With Hollow Handle, Fig. 4

Catalog #	Size, Blade Width
RT-475-04	31.5cm (12 1/2"), 25 mm



**Deaver Retractor**  
With Hollow Handle, Fig. 7

Catalog #	Size, Blade Width
RT-475-07	31.5cm (12 1/2"), 38 mm



**Deaver Retractor**  
With Hollow Handle, Fig. 8

Catalog #	Size, Blade Width
RT-475-08	31.5 cm (12 1/2"), 50 mm



**Deaver Retractor**  
With Hollow Handle, Fig. 10

Catalog #	Size, Blade Width
RT-475-10	31.5cm (12 1/2"), 100 mm



**Leriche Retractor**

Catalog #	Size, Blade Width
RT-479-01	25.5cm (10"), 45 mm
RT-479-02	27.5cm (10 3/4"), 60 mm





Retractors, Atrium Retractors  
Wundhaken, Wundhäkchen, Atriumhaken  
Separadores, Separadores para atrio  
Ecarteurs, Ecarteurs pour atrium  
Divaricatori, Divaricatori per atrio

**Kummel Retractor**



Catalog #	Size, Blade Size
RT-479-03	28.5 cm (11 1/4"), 46 mm

**Koerte Retractor**

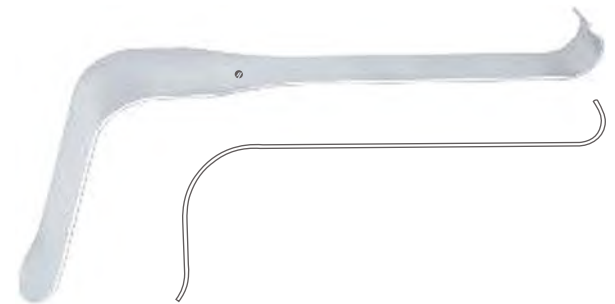

Catalog #	Size, Blade Size
RT-481-30	30 cm (11 3/4"), 46 mm

**Cooley Retractor  
Right**



Catalog #	Size, Blade Size
RT-485-01	25 cm (9 3/4"), 48 x 48 mm

**Cooley Retractor  
Right, Serrated**



Catalog #	Size, Blade Size, Profile
RT-485-02	25 cm (9 3/4"), 48 x 48 mm

**Cooley Retractor  
Left**



Catalog #	Size, Blade Size
RT-485-03	27 cm (10 3/4"), 30 x 48 mm



Retractors, Pelvis Retractors  
Wundhaken, Pelvishaken  
Separadores, Separadores para pelvis  
Ecarteurs, Ecarteurs pour pelvis  
Divaricatori, Divaricatori per pelvis

**Mikulicz Liver Retractor**

Catalog #	Size, Blade Size
RT-489-01	25 cm (9 3/4"), 90 x 35 mm
RT-489-02	25 cm (9 3/4"), 125 x 50 mm
RT-489-03	25 cm (9 3/4"), 160 x 50 mm

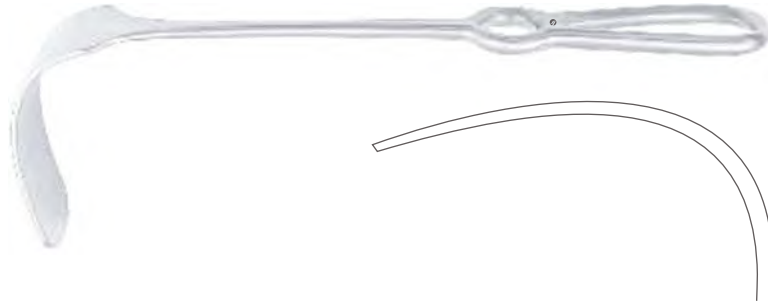

**Mikulicz Retractor**

Catalog #	Size, Blade Size
RT-491-26	26 cm (10 1/4"), 90 x 55 mm



**Kelly Retractor**

Catalog #	Size, Blade Size
RT-495-01	27.5 cm (10 3/4"), 205 x 38 mm
RT-495-02	27.5 cm (10 3/4"), 205 x 57 mm

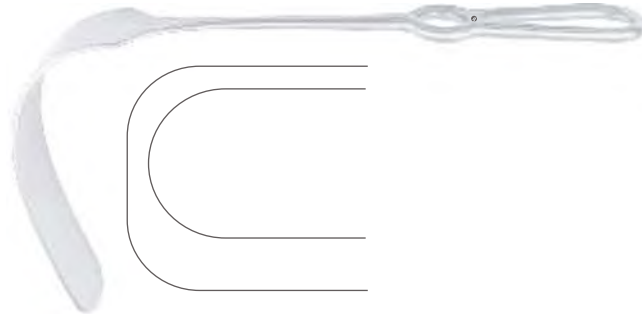

**St. Marks Pelvis Retractor**

Catalog #	Size, Blade Size
RT-501-01	29 cm (11 1/2"), 142 x 60 mm - 35 x 45 mm
RT-501-02	29 cm (11 1/2"), 193 x 60 mm - 60 x 45 mm
RT-501-03	33 cm (13"), 195 x 60 mm - 60 x 45 mm

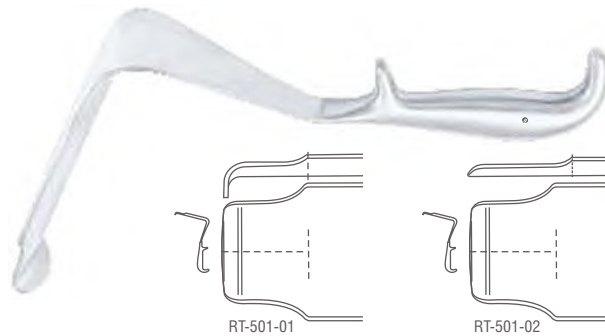

**Kummel Abdominal Spatula**

Catalog #	Size, Blade Width
RT-511-28	31 cm (12 1/4"), 45 mm





Abdominal Spatulas  
Bauchspatel  
Espátulas abdominales  
Spatules abdominales  
Spatole addominali

**Kader Abdominal Spatula**



Catalog #	Size, Blade Width
RT-515-20	28 cm (11"), 20 mm
RT-515-30	28 cm (11"), 30 mm
RT-515-40	28 cm (11"), 40 mm

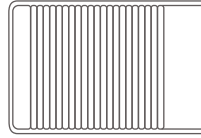

**Abdominal Spatula**



Catalog #	Size, Blade Width
RT-520-30	41 cm (16"), 30 mm
RT-520-40	41 cm (16"), 40 mm
RT-520-50	41 cm (16"), 50 mm
RT-520-60	41 cm (16"), 60 mm
RT-520-70	41 cm (16"), 70 mm

**Reverdin Abdominal Spatula**



Catalog #	Size, Blade Size
RT-523-28	28.5 cm (11 1/4"), 63 x 45 mm

**Abdominal Spatula**



Catalog #	Size, Blade Width
RT-530-20	33 cm (13"), 20 mm
RT-530-25	33 cm (13"), 25 mm
RT-530-30	33 cm (13"), 30 mm
RT-530-40	33 cm (13"), 40 mm
RT-530-50	33 cm (13"), 50 mm



Abdominal Spatulas, Retractors  
Bauchspatel, Wundhaken, Wundhäkchen  
Espátulas abdominales, Separadores  
Spatules abdominales, Ecarteurs  
Spatole addominali, Divaricatori

**Tuffier Abdominal Spatula**  
Tapered



Catalog #	Size, Blade Width
RT-534-20	20 cm (8"), 16 x 25 mm

**Heberer Abdominal Spatula**  
Tapered



Catalog #	Size, Blade Size
RT-536-01	28 cm (11"), 25 x 30 mm
RT-536-02	30 cm (11 3/4"), 37 x 45 mm
RT-536-03	30.5 cm (12"), 40 x 50 mm

**Martin Abdominal Spatula**  
Malleable, Very Soft



Catalog #	Size, Blade Width
RT-540-06	20 cm (8"), 6.5 mm
RT-540-09	20 cm (8"), 9.5 mm
RT-540-13	20 cm (8"), 13 mm
RT-540-16	20 cm (8"), 16 mm
RT-540-19	20 cm (8"), 19 mm
RT-540-25	20 cm (8"), 25 mm

**Prostate Retractor**



Catalog #	Size
RT-543-36	36 cm (14 1/4")

**Urethral Retractor**



Catalog #	Size
RT-545-39	39 cm (15 1/2")



Retractors  
Wundhaken, Wundhäkchen  
Separadores  
Ecarteurs  
Divaricatori

**Collin-Hartmann Retractor**



Catalog #	Size
RT-551-01	15 cm (6")

**Sternberg Retractor**

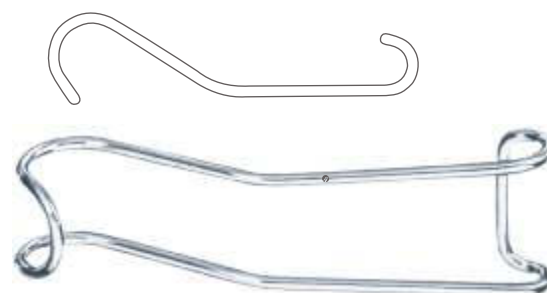

Catalog #	Size
RT-553-01	12 cm (4 3/4")
RT-553-02	13 cm (5")
RT-553-03	13.5 cm (5 1/4")

**Roux-Mini Retractor**

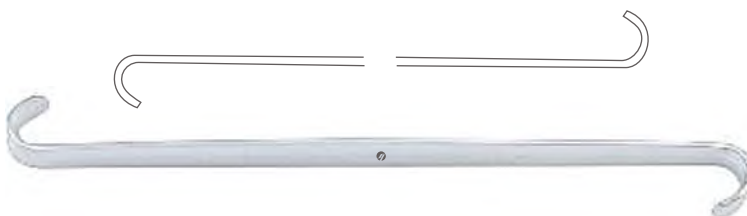

Catalog #	Size, Blade Width
RT-557-14	14.5 cm (5 3/4"), 6 x 7 mm - 7 x 8 mm

**Roux-Baby Retractor**

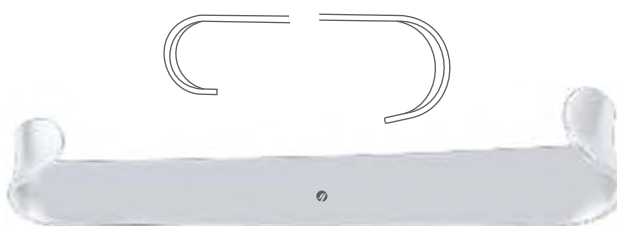

Catalog #	Size, Blade Width
RT-559-12	12.5 cm (5"), 17 x 17 mm - 24 x 21 mm

**Roux Retractor**

Set of Fig. 1, Fig. 2 and Fig. 3

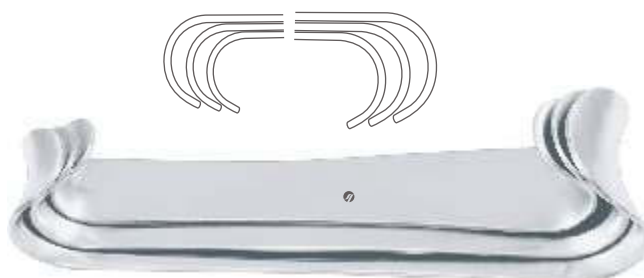

Catalog #	Size
RT-561-00	N/A





Retractors  
Wundhaken, Wundhäkchen  
Separadores  
Ecarteurs  
Divaricatori

**Roux Retractor**

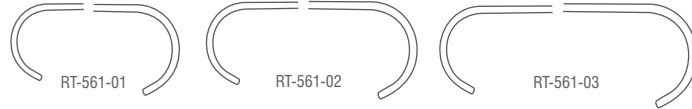

Catalog #	Size, Profile
RT-561-01	14 cm (5 1/2"), Fig. 1
RT-561-02	15 cm (6"), Fig. 2
RT-561-03	17 cm (6 3/4"), Fig. 3

**Farabeuf Retractor**  
Set of Fig. 1 and Fig. 2

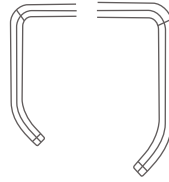

Catalog #	Size, Blade Size Fig. 1, Blade Size Fig. 2
RT-565-00	12 cm (4 3/4"), 26 x 10 mm - 30 x 13 mm, 30 x 10 mm - 34 x 13 mm

**Farabeuf Retractor**  
Set of Fig. 1 and Fig. 2

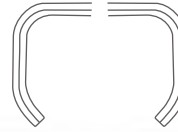

Catalog #	Size, Blade Size Fig. 1, Blade Size Fig. 2
RT-567-00	15 cm (6"), 23 x 16 mm - 26 x 16 mm, 27 x 16 mm - 30 x 16 mm

**Parker Retractor**  
Set of Fig. 1 and Fig. 2

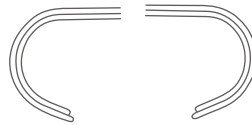

Catalog #	Size, Blade Size Fig. 1, Blade Size Fig. 2
RT-571-01	13.5 cm (5 1/4"), 19 x 15 mm - 19 x 15 mm, 22 x 15 mm - 22 x 15 mm
RT-571-02	17.5 cm (7"), 26 x 25 mm - 27 x 25 mm, 29 x 25 mm - 27 x 25 mm

**Parker-Mott Retractor**  
Set of Fig. 1 and Fig. 2

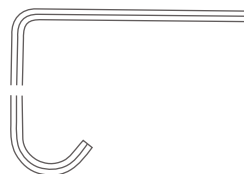

Catalog #	Size, Blade Size Fig. 1, Blade Size Fig. 2
RT-573-16	16 cm (6 1/4"), 21 x 24 mm - 68 x 24 mm, 25 x 24 mm - 72 x 24 mm



Retractors  
Wundhaken, Wundhäkchen  
Separadores  
Ecarteurs  
Divaricatori

**Mathieu Retractor**  
Set of Fig. 1 and Fig. 2

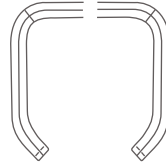

Catalog #	Size, Blade Size Fig. 1, Blade Size Fig. 2
RT-577-20	20 cm (8"), 42 x 13 mm - 42 x 26 mm / 47 x 13 mm - 46 x 26 mm

**Parker-Longenbeck (US Army) Retractor**  
Set of Fig. 1 and Fig. 2

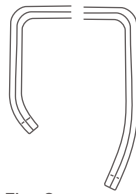

Catalog #	Size, Blade Size Fig. 1, Blade Size Fig. 2
RT-579-21	21.5 cm (8 1/2"), 21 x 15 mm - 40 x 15 mm / 25 x 15 mm - 45 x 15 mm

**Hajek Retractor**



Catalog #	Size, Blade Size
RT-581-16	16.5 cm (6 1/2"), 30 x 18 mm - 25 x 10 mm

**Lane Retractor**



Catalog #	Size, Blade Width
RT-583-01	23 cm (9"), 30 x 13 mm - 35 x 19 mm
RT-583-02	23 cm (9"), 30 x 25 mm - 35 x 32 mm

**Czerny Retractor**



Catalog #	Size, Blade Width
RT-591-17	17.5 cm (7"), 38 x 22 mm - 38 x 22 mm



Retractors  
Wundhaken, Wundhäkchen  
Separadores  
Ecarteurs  
Divaricatori

**Goelet Retractor**

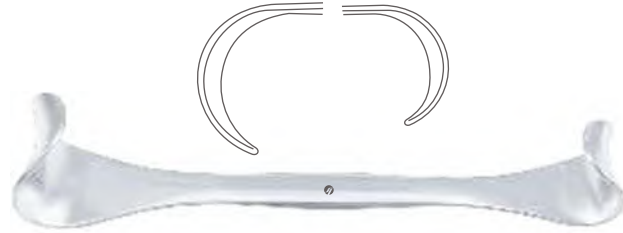

Catalog #	Size, Blade Width
RT-593-19	19 cm (7 1/2"), 40 x 40 mm - 30 x 30 mm

**Cranny-Ryall Retractor**



Catalog #	Size, Blade Width
RT-595-01	19 cm (7 1/2"), 16 mm
RT-595-02	19 cm (7 1/2"), 20 mm
RT-595-03	20 cm (8"), 25 mm

**Finsen Wound Spreader**  
2 x 3 Sharp Prongs



Catalog #	Size
RT-650-05	5 cm (2")

**Finsen Wound Spreader**  
2 x 3 Blunt Prongs



Catalog #	Size
RT-651-05	5 cm (2")

**Finsen Wound Spreader**  
3 x 4 Sharp Prongs



Catalog #	Size
RT-652-07	7 cm (2 3/4")



Wound Spreaders, Self-Retaining  
Wundspreizer  
Separadores autoestáticos  
Ecarteurs autostatiques  
Divaricatori autostatici

**Finsen Wound Spreader**  
3 x 4 Blunt Prongs

Catalog #	Size
RT-653-07	7 cm (2 3/4")



**Finsen-Martin Wound Spreader**  
3 x 4 Sharp Prongs, With Adjustment Screw

Catalog #	Size
RT-654-07	7 cm (2 3/4")



**Finsen-Martin Wound Spreader**  
3 x 4 Blunt Prongs, With Adjustment Screw

Catalog #	Size
RT-655-07	7 cm (2 3/4")



**Logan Wound Spreader**  
3 x 3 Sharp - With Adjustment Screw

Catalog #	Size
RT-658-04	4 cm (1 1/2")

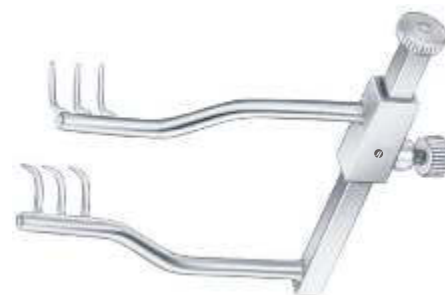

**Bose Fat Spreader for Coronary Surgery**

Catalog #	Size
RT-661-30	3 cm (1 1/4")





Wound Spreaders, Self-Retaining  
Wundspreizer  
Separadores autoestáticos  
Ecarteurs autostatiques  
Divaricatori autostatici

**Fat Spreader for Coronary Surgery**

Catalog #	Size
RT-663-40	4 cm (1 1/2")
RT-663-50	5.5 cm (2 1/4")

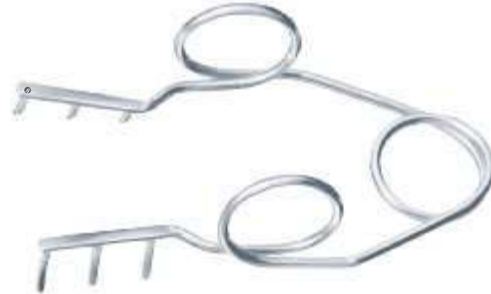

**Buckley Wound Spreader**  
3 x 3 Sharp Prongs

Catalog #	Size
RT-666-06	6 cm (2 1/4")

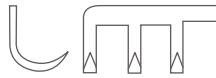

**Alm Wound Spreader**  
4 x 4 Sharp Prongs

Catalog #	Size
RT-668-07	7 cm (2 3/4")
RT-668-10	10 cm (4")



**Alm Wound Spreader**  
4 x 4 Blunt Prongs

Catalog #	Size
RT-669-07	7 cm (2 3/4")
RT-669-10	10 cm (4")



**Allport Wound Spreader**  
4 x 4 Sharp Prongs

Catalog #	Size
RT-672-10	9.5 cm (3 3/4")





Wound Spreaders, Self-Retaining  
Wundspreizer  
Separadores autoestáticos  
Ecarteurs autostatiques  
Divaricatori autostatici

**Wound Spreader**  
4 x 4 Sharp Prongs



Catalog #	Size
RT-674-10	10 cm (4")

**Wound Spreader**  
4 x 4 Blunt Prongs



Catalog #	Size
RT-675-10	10 cm (4")

**Jansen Self Retaining Retractor**  
3 x 3 Blunt Prongs, With Adjustment Screw

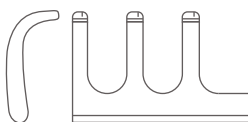

Catalog #	Size
RT-677-10	10 cm (4")

**Scalp-Contour Self Retaining Retractor**  
3 x 4 Sharp Prongs

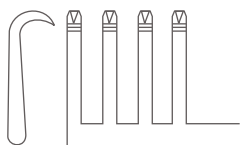

Catalog #	Size
RT-680-13	13.5 cm (5 1/4")



Wound Spreaders, Self-Retaining  
Wundspreizer  
Separadores autoestáticos  
Ecarteurs autostatiques  
Divaricatori autostatici

**Scalp-Contour Self Retaining Retractor**  
3 x 4 Blunt Prongs

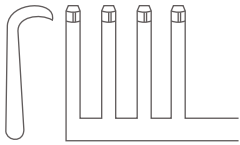

Catalog #	Size
RT-681-13	13.5 cm (5 1/4")

**Anderson-Adson Self Retaining Retractor**  
4 x 4 Sharp Prongs

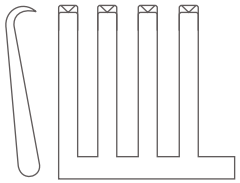

Catalog #	Size
RT-686-20	20 cm (8")

**Anderson-Adson Self Retaining Retractor**  
4 x 4 Blunt Prongs

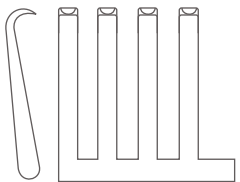

Catalog #	Size
RT-687-20	20 cm(8")





Wound Spreaders, Self-Retaining  
Wundspreizer  
Separadores autoestáticos  
Ecarteurs autostatiques  
Divaricatori autostatici

**Traverse Self Retaining Retractor**  
4 x 5 Blunt Prongs



Catalog #	Size
RT-689-21	21.5 cm (8 1/2")

**Norfolk-Norwich Self Retaining Retractor**  
4 x 5 Blunt Prongs

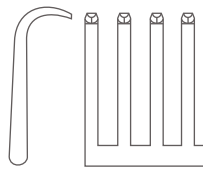

Catalog #	Size
RT-691-22	22 cm (8 3/4")

**Weitlaner Self Retaining Retractor**  
3 x 4 Sharp Prongs

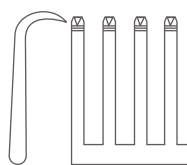

Catalog #	Size
RT-696-20	20 cm (8")





Wound Spreaders, Self-Retaining  
Wundspreizer  
Separadores autoestáticos  
Ecarteurs autostatiques  
Divaricatori autostatici

**Weitlaner Self Retaining Retractor**  
3 x 4 Blunt Prongs

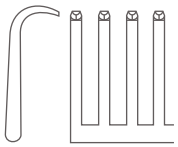

Catalog #	Size
RT-697-20	20 cm (8")

**Adson Self Retaining Retractor**  
3 x 4 Sharp Prongs

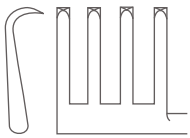

Catalog #	Size
RT-700-26	26 cm (10 1/4")

**Adson Self Retaining Retractor**  
3 x 4 Blunt Prongs

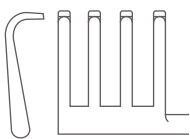

Catalog #	Size
RT-701-26	26 cm (10 1/4")



Wound Spreaders, Self-Retaining  
Wundspreizer  
Separadores autoestáticos  
Ecarteurs autostatiques  
Divaricatori autostatici

**Adson Self Retaining Retractor**  
6 x 6 Sharp Prongs

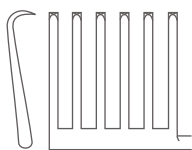

Catalog #	Size
RT-702-26	29 cm (11 1/2")

**Adson Self Retaining Retractor**  
6 x 6 Blunt Prongs

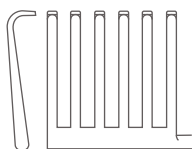

Catalog #	Size
RT-703-26	29 cm (11 1/2")

**Weitlaner Self Retaining Retractor**  
2 x 3 Sharp Prongs

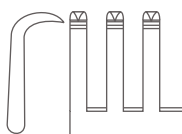

Catalog #	Size
RT-710-11	11 cm (4 1/4")



Wound Spreaders, Self-Retaining  
Wundspreizer  
Separadores autoestáticos  
Ecarteurs autostatiques  
Divaricatori autostatici

**Weitlaner Self Retaining Retractor**  
2 x 3 Blunt Prongs

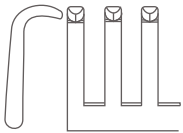

Catalog #	Size
RT-711-11	11 cm (4 1/4")

**Weitlaner Self Retaining Retractor**  
3 x 4 Sharp Prongs

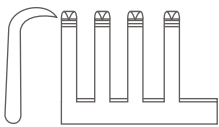

Catalog #	Size
RT-712-13	13.5 cm (5 1/4")
RT-712-16	16 cm (6 1/4")

**Weitlaner Self Retaining Retractor**  
3 x 4 Blunt Prongs

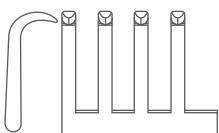

Catalog #	Size
RT-713-13	13.5 cm (5 1/4")
RT-713-16	16 cm (6 1/4")



Wound Spreaders, Self-Retaining  
Wundspreizer  
Separadores autoestáticos  
Ecarteurs autostatiques  
Divaricatori autostatici

**Weitlaner-Wullstein Self Retaining Retractor**  
3 x 3 Sharp Prongs

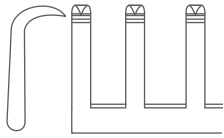

Catalog #	Size
RT-716-13	13 cm (5")

**Weitlaner-Wullstein Self Retaining Retractor**  
3 x 3 Blunt Prongs

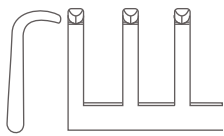

Catalog #	Size
RT-717-13	13 cm (5")

**Perkins Self Retaining Retractor**

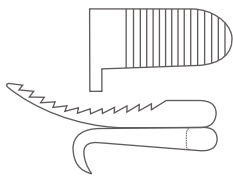

Catalog #	Size, Profile
RT-721-01	13 cm (5"), Right



Wound Spreaders, Self-Retaining  
Wundspreizer  
Separadores autoestáticos  
Ecarteurs autostatiques  
Divaricatori autostatici

**Perkins Self Retaining Retractor**

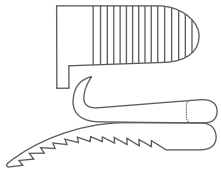

Catalog #	Size, Profile
RT-721-02	13 cm (5"), Left

**Jefferson Self Retaining Retractor**  
2 x 3 Blunt Prongs

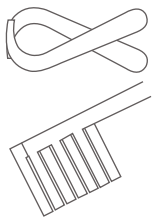

Catalog #	Size
RT-725-14	14 cm (5 1/2")

**Mollison Self Retaining Retractor**  
2 x 2 Sharp Prongs



Catalog #	Size
RT-728-14	14 cm (5 1/2")



Wound Spreaders, Self-Retaining  
Wundspreizer  
Separadores autoestáticos  
Ecarteurs autostatiques  
Divaricatori autostatici

**Mollison Self Retaining Retractor**  
4 x 4 Sharp Prongs

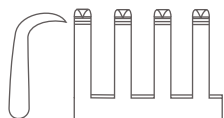

Catalog #	Size
RT-730-15	15.5 cm (6")

**Plester Self Retaining Retractor**  
2 x 2 Sharp Prongs

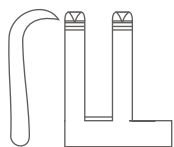

Catalog #	Size
RT-732-13	13 cm (5")

**Plester Self Retaining Retractor**  
2 x 2 Blunt Prongs

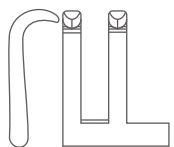

Catalog #	Size
RT-733-13	13 cm (5")





Wound Spreaders, Self-Retaining  
Wundspreizer  
Separadores autoestáticos  
Ecarteurs autostatiques  
Divaricatori autostatici

**Plester Self Retaining Retractor**

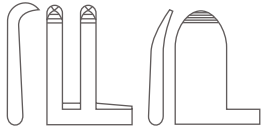

Catalog #	Size, Profile
RT-735-01	10.5 cm (4"), Left
RT-735-02	10.5 cm (4"), Right

**Milligan Self Retaining Retractor**

3 x 3 Blunt Prongs

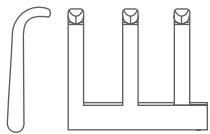

Catalog #	Size
RT-737-13	13.5 cm (5 1/4")

**Weitlaner-Baby Self Retaining Retractor**

Blunt

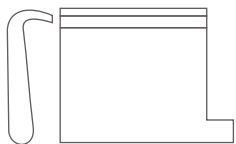

Catalog #	Size
RT-739-13	13.5 cm (5 1/4")



Wound Spreaders, Self-Retaining  
Wundspreizer  
Separadores autoestáticos  
Ecarteurs autostatiques  
Divaricatori autostatici

**Adson Self Retaining Retractor**  
3 x 4 Sharp Prongs

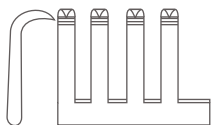

Catalog #	Size
RT-742-13	14 cm (5 1/2")
RT-742-16	16.5 cm (6 1/2")
RT-742-21	21 cm (8 1/4")
RT-742-24	24.5 cm (9 3/4")

**Adson Self Retaining Retractor**  
3 x 4 Blunt Prongs

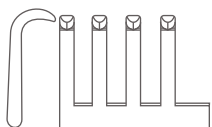

Catalog #	Size
RT-743-13	14 cm (5 1/2")
RT-743-16	16.5 cm (6 1/2")
RT-743-21	21 cm (8 1/4")
RT-743-24	24.5 cm (9 3/4")

**Beckmann Self Retaining Retractor**  
4 x 4 Sharp Prongs

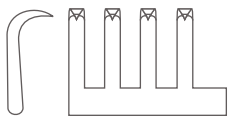

Catalog #	Size
RT-750-32	32 cm (12 1/2")





Abdominal Retractors  
Bauchdeckenhalter  
Separadores abdominales  
Ecarteurs abdominaux  
Divaricatori addominali

**Adson Self Retaining Retractor**  
4 x 5 Blunt Prongs

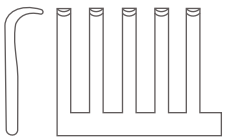

Catalog #	Size
RT-753-33	33 cm (13")

**Harvey-Jackson Self Retaining Retractor**  
3 x 3 Sharp Prongs

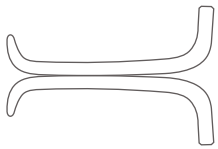

Catalog #	Size
RT-758-28	28 cm (11")

**Beckmann-Adson Self Retaining Retractor**  
4 x 4 Short Sharp Prongs

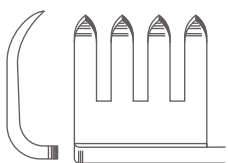

Catalog #	Size
RT-760-30	30.5 cm (12")



Wound Spreaders, self-retaining  
Wundspreizer  
Separadores autoestáticos  
Ecarteurs autostatiques  
Divaricatori autostatici

**Beckmann-Adson Self Retaining Retractor**  
4 x 4 Short Blunt Prongs

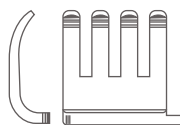

Catalog #	Size
RT-761-30	30.5 cm (12")

**Beckmann-Adson Self Retaining Retractor**  
4 x 4 Long Sharp Prongs

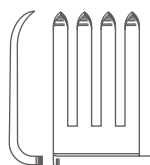

Catalog #	Size
RT-762-30	30.5 cm (12")

**Beckmann-Adson Self Retaining Retractor**  
4 x 4 Long Blunt Prongs

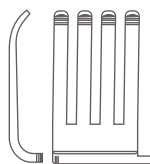

Catalog #	Size
RT-763-30	30.5 cm (12")



Wound Spreaders, self-retaining  
Wundspreizer  
Separadores autoestáticos  
Ecarteurs autostatiques  
Divaricatori autostatici

**Beckmann-Eaton Self Retaining Retractor**  
7 x 7 Sharp Prongs

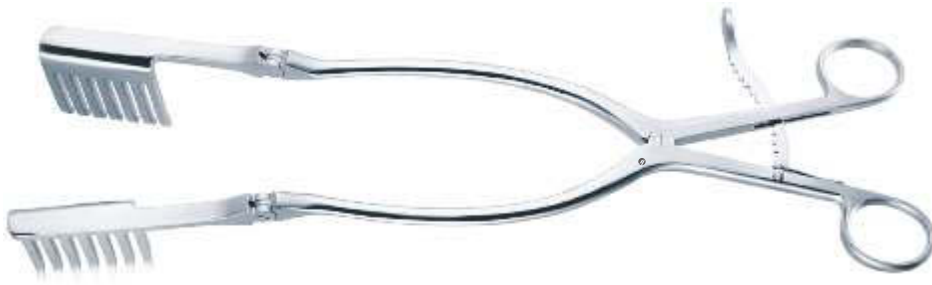
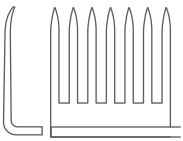

Catalog #	Size
RT-766-32	32 cm (12 1/2")

**Martin Self Retaining Retractor**  
6 x 6 Sharp Long Prongs

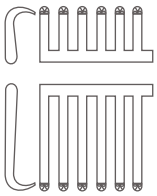

Catalog #	Size, Profile
RT-770-01	28.5 cm (11 1/4"), Teeth on Left Side
RT-770-02	28.5 cm (11 1/4"), Teeth on Right Side

**Joll (Friedman) Self Retaining Retractor**  
Thyroid and Vaginal Retractor



Catalog #	Size
RT-801-15	15.5 cm (6")



Wound Spreaders, self-retaining  
Wundspreizer  
Separadores autoestáticos  
Ecarteurs autostatiques  
Divaricatori autostatici

**Gelpi Self Retaining Retractor**



Catalog #	Size
RT-805-13	13 cm (5")
RT-805-15	15 cm (6")
RT-805-18	18.5 cm (7 1/4")

**Gelpi Self Retaining Retractor**



Catalog #	Size
RT-807-10	10 cm (4")
RT-807-14	14.5 cm (5 3/4")
RT-807-18	18 cm (7")

**Gelpi Self Retaining Retractor**



Catalog #	Size
RT-811-18	18.5 cm (7 1/4")



Wound Spreaders, self-retaining  
Wundspreizer  
Separadores autoestáticos  
Ecarteurs autostatiques  
Divaricatori autostatici

**Jackson-Burrows Self Retaining Retractor**

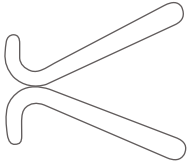

Catalog #	Size
RT-813-18	18.5 cm (7 1/4")

**Collin-Baby Retractor Complete**



Catalog #	Size
RT-820-00	20 cm (8")

**Collin Retractor Complete**

With Pair of Lateral Blades Ref: RT-835-38



Catalog #	Size
RT-822-00	Standard



Abdominal Retractors  
Bauchdeckenhalter  
Separadores abdominales  
Ecarteurs abdominaux  
Divaricatori addominali

**Collin Retractor Only**  
Without Blade



Catalog #	Size
RT-822-01	24 cm (9 1/2")

**Collin Retractor Complete**

With Central Blades Ref: RT-823-90 and 1 Pair of  
Lateral Blades Ref: RT-835-38



Catalog #	Size
RT-823-00	Standard

**Collin Retractor Only**  
Without Blades



Catalog #	Size
RT-823-01	22.5 cm (8 3/4")



Abdominal Retractors  
Bauchdeckenhalter  
Separadores abdominales  
Ecarteurs abdominaux  
Divaricatori addominali

**Collin Central Blade**



Catalog #	Blade Size
RT-823-90	38 x 55 mm

**Collin Retractor Complete**

With Central Blade Ref:- RT-824-90 and 1 Pair of Lateral Blades Ref:- RT-835-45



Catalog #	Size
RT-824-00	22.5 cm (8 ¾")

**Collin Central Blade**



Catalog #	Blade Size
RT-824-90	50 x 75 mm





Abdominal Retractors  
Bauchdeckenhalter  
Separadores abdominales  
Ecarteurs abdominaux  
Divaricatori addominali

**Collin Retractor Complete**

With Central Blade Ref:- RT-826-90 and 1 Pair of  
Lateral Blades Ref:- RT-835-60



Catalog #	Size
RT-826-00	Standard

**Collin Retractor Only**  
Without Blades



Catalog #	Size
RT-826-01	31 cm (12 1/4")

**Collin Central Blade**



Catalog #	Blade Size
RT-826-90	60 x 75 mm





Abdominal Retractors  
Bauchdeckenhalter  
Separadores abdominales  
Ecarteurs abdominaux  
Divaricatori addominali

**Ricard Retractor Complete**

With Central Blade Ref:- RT-830-02 and 1 Pair of Lateral Blades Ref:- RT-835-90



Catalog #	Size
RT-830-00	Standard

**Ricard Retractor Only**



Catalog #	Size
RT-830-01	Standard

**Collin Central Blade**



Catalog #	Blade Size
RT-830-02	55 x 70 mm



Abdominal Retractors  
Bauchdeckenhalter  
Separadores abdominales  
Ecarteurs abdominaux  
Divaricatori addominali

**Ricard Retractor Complete**

With Central Blade Ref:- RT-832-02 and 1 Pair of Lateral Blades Ref:- RT-835-92



Catalog #	Size
RT-832-00	Standard

**Ricard Central Blade**



Catalog #	Blade Size
RT-832-02	80 x 90 mm

**Ricard Central Blade**

Catalog #	Blade Size
RT-835-18	18 x 40 mm
RT-835-27	27 x 40 mm
RT-835-38	38 x 60 mm
RT-835-40	40 x 80 mm
RT-835-45	45 x 80 mm
RT-835-50	50 x 70 mm
RT-835-52	52 x 110 mm
RT-835-60	60 x 80 mm
RT-835-70	70 x 55 mm
RT-835-80	75 x 90 mm
RT-835-90	50 x 58 mm
RT-835-92	60 x 80 mm
RT-835-94	72 x 85 mm

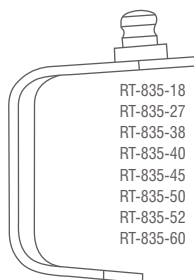

- RT-835-18
- RT-835-27
- RT-835-38
- RT-835-40
- RT-835-45
- RT-835-50
- RT-835-52
- RT-835-60

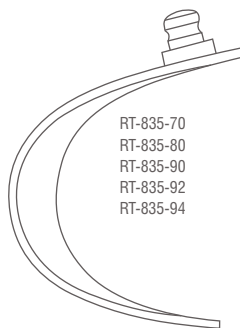

- RT-835-70
- RT-835-80
- RT-835-90
- RT-835-92
- RT-835-94





Abdominal Retractors  
Bauchdeckenhalter  
Separadores abdominales  
Ecarteurs abdominaux  
Divaricatori addominali

**Henley Retractor Complete**

3 x 4 Sharp Prongs, With 3 Central Blades Ref:- RT-840-19, RT-840-25 and RT-840-32

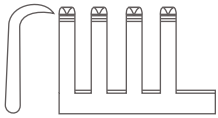

Catalog #	Size
RT-840-01	16 cm (6 1/4")

**Henley Retractor Complete**

3 x 4 Blunt Prongs, With 3 Central Blades Ref:- RT-840-19, RT-840-25 and RT-840-32

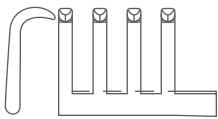

Catalog #	Size
RT-840-02	16 cm (6 1/4")

**Henley Central Blade**

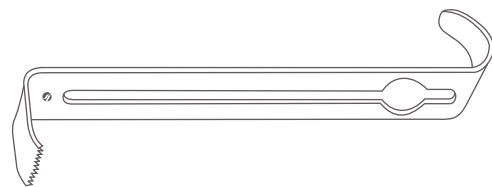

Catalog #	Blade Size
RT-840-19	19 x 17 mm
RT-840-25	25 x 17 mm
RT-840-32	32 x 17 mm



Abdominal Retractors  
Bauchdeckenhalter  
Separadores abdominales  
Ecarteurs abdominaux  
Divaricatori addominali

**Millin Retractor Complete**

With Central Blade Ref:- RT-850-90, 1 Pair Each of  
Lateral Blades Ref:- RT-851-57 and Ref:- RT-851-82



Catalog #	Size
RT-850-00	Standard

**Millin Retractor Only**



Catalog #	Size
RT-850-01	Standard

**Millin Central Blade Only**



Catalog #	Blade Size
RT-850-90	105 x 45 mm



Abdominal Retractors  
Bauchdeckenhalter  
Separadores abdominales  
Ecarteurs abdominaux  
Divaricatori addominali

**Millin Lateral Blade**

Catalog #	Blade Size
RT-851-57	57 x 25 mm
RT-851-82	82 x 25 mm



**Lagueu Retractor**

Catalog #	Size, Blade Size
RT-853-26	26 cm (10 1/4"), 90 x 35 mm



**Millin Retractor**

Catalog #	Size, Spread
RT-855-28	28 cm (11"), 70 mm



**Judd-Masson Retractor**

Catalog #	Spread
RT-858-00	120 mm





Abdominal Retractors  
Bauchdeckenhalter  
Separadores abdominales  
Ecarteurs abdominaux  
Divaricatori addominali

**Vickers Low-Profile Retractor Complete**

2 x 2 Blunt Prongs, With Central Blade Ref:- RT-801-01

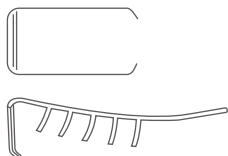

Catalog #	Size
RT-861-00	7.5 cm (3")

**Vickers Low-Profile Central Blade**

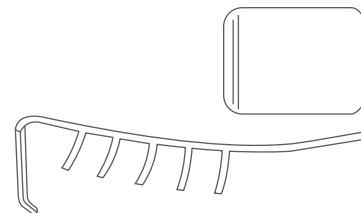

Catalog #	Blade Size
RT-861-01	10 x 18 mm
RT-861-02	12 x 10 mm

**Vickers Low-Profile Retractor Complete**

3 x 3 Blunt Prongs, With Central Blade Ref:- RT-861-01



Catalog #	Size
RT-863-00	9 cm (3 1/2")



Abdominal Retractors  
Bauchdeckenhalter  
Separadores abdominales  
Ecarteurs abdominaux  
Divaricatori addominali

**Vickers Low-Profile Retractor Complete**  
With Central Blade Ref:- RT-861-01



Catalog #	Size
RT-865-00	7.5 cm (3")

**Vickers Self Retaining Retractor**  
Blunt Ring Model For Thumb And Fingers



Catalog #	Size
RT-869-00	5 cm (2")

**Gosset-Baby Retractor**



Catalog #	Size, Spread, Lateral Blades Size
RT-880-00	12.5 cm(5"), 120 mm, 40 x 30 mm



Abdominal Retractors  
Bauchdeckenhalter  
Separadores abdominales  
Ecarteurs abdominaux  
Divaricatori addominali

**Gosset Retractor Complete**

With Central Blade Ref:- RT-884-90



Catalog #	Size, Spread, Lateral Blades Size
RT-884-00	16.5 cm (6 1/2"), 160 mm, 63 x 35 mm

**Gosset Central Blade**



Catalog #	Blade Size
RT-884-90	60 x 56 mm

**Gosset Retractor**



Catalog #	Size
RT-886-00	18.5 cm (7 1/4")





Abdominal Retractors  
Bauchdeckenhalter  
Separadores abdominales  
Ecarteurs abdominaux  
Divaricatori addominali

**Balfour-Baby Retractor Complete**  
With Central Blade Ref:- RT-890-90



Catalog #	Size, Spread
RT-890-00	12.5 cm (5"), 95 mm

**Balfour-Baby Central Blade**



Catalog #	Blade Size
RT-890-90	24 x 20 mm

**Balfour Retractor Complete**  
With Central Blade Ref:- RT-903-01



Catalog #	Size, Spread, Lateral Blades Size
RT-892-00	20 cm (8"), 180 mm, 70 x 35 mm



Abdominal Retractors  
Bauchdeckenhalter  
Separadores abdominales  
Ecarteurs abdominaux  
Divaricatori addominali

**Balfour Retractor Complete**  
With Central Blade Ref:- RT-903-01



Catalog #	Size, Spread, Lateral Blades Size
RT-894-00	20 cm (8"), 180 mm, 70 x 35 mm

**Balfour Retractor Complete**  
With Central Blade Ref:- RT-903-01



Catalog #	Size, Spread, Lateral Blades Size
RT-896-00	20 cm (8"), 200 mm, 100 x 35 mm

**Balfour-Standard Retractor Complete**  
With Central Blade Ref:- RT-903-02



Catalog #	Size, Spread, Lateral Blades Size
RT-898-00	20 cm (8"), 250 mm, 100 x 35 mm



Abdominal Retractors  
Bauchdeckenhalter  
Separadores abdominales  
Ecarteurs abdominaux  
Divaricatori addominali

**Balfour Central Blade Retractor**

Catalog #	Blades Size
RT-901-90	100 x 70 mm
RT-901-91	100 x 60 mm



**Balfour Central Blade**

Catalog #	Blade Size
RT-903-01	40 x 80 mm
RT-903-02	68 x 85 mm
RT-903-03	40 x 68 mm



**Balfour-Modell USA Retractor Complete**

With 1 Pair Each of Lateral Blades Ref:- RT-906-06 and RT-906-08 and Central Blade RT-903-02

Catalog #	Spread
RT-906-00	190 mm



**Balfour-Modell USA Lateral Blade**

Catalog #	Blade Depth
RT-906-06	60 mm Deep
RT-906-08	80 mm Deep





Abdominal Retractors  
Bauchdeckenhalter  
Separadores abdominales  
Ecarteurs abdominaux  
Divaricatori addominali

**Goligher Retractor Complete**

With Central Blades Ref:- RT-910-90 and RT-910-91



Catalog #	Spread
RT-910-00	185 mm

**Goligher Lateral Blade**



Catalog #	Blade Depth
RT-910-05	51 mm Deep
RT-910-10	102 mm Deep

**Goligher Central Blade**



Catalog #	Blade Depth
RT-910-90	51 mm Deep
RT-910-91	102 mm Deep



Abdominal Retractors  
Bauchdeckenhalter  
Separadores abdominales  
Ecarteurs abdominaux  
Divaricatori addominali

**Charnley Retractor Complete**



Catalog #	Size
RT-914-00	Standard

**O'Sullivan-O'Connor Retractor Complete**

With 2 Fixed Blades, 1 Blade Ref:- RT-910-91 and  
2 Blades Ref:- RT-910-90



Catalog #	Size
RT-920-00	Standard

**O'Sullivan-O'Connor Blade**



Catalog #	Size
RT-920-90	80 x 45 mm
RT-920-91	110 x 70 mm



Abdominal Retractors  
Bauchdeckenhalter  
Separadores abdominales  
Ecarteurs abdominaux  
Divaricatori addominali

**Kirschner Retractor Complete**

With Frame RT-920-30, 3 Blades Ref:- RT-923-50 and  
1 Blade Each of RT-923-80, RT-923-98 and RT-923-99



Catalog #	Size
RT-922-00	Standard

**Kirschner Frame Only**



Catalog #	Frame Size
RT-922-30	340 x 240 mm

**Kirschner Blade**

Catalog #	Blade Size
RT-923-40	40 x 55 mm
RT-923-50	50 x 65 mm
RT-923-60	60 x 85 mm
RT-923-78	78 x 65 mm
RT-923-80	80 x 90 mm
RT-923-98	98 x 50 mm
RT-923-99	105 x 35 mm



RT-923-40  
RT-923-50  
RT-923-60  
RT-923-78  
RT-923-80

RT-923-98  
RT-923-99



Abdominal Retractors, Wound Spreaders, self-retaining  
Bauchdeckenhalter, Wundspreizer  
Separadores abdominales, Separadores autoestáticos  
Ecarteurs abdominaux, Ecarteurs autostatiques  
Divaricatori addominali, Divaricatori autostatici

**Kirschner Retractor Complete**

With Frame RT-924-24, 2 Blades Ref:- RT-923-40  
and 2 Blades Ref:- RT-923-50

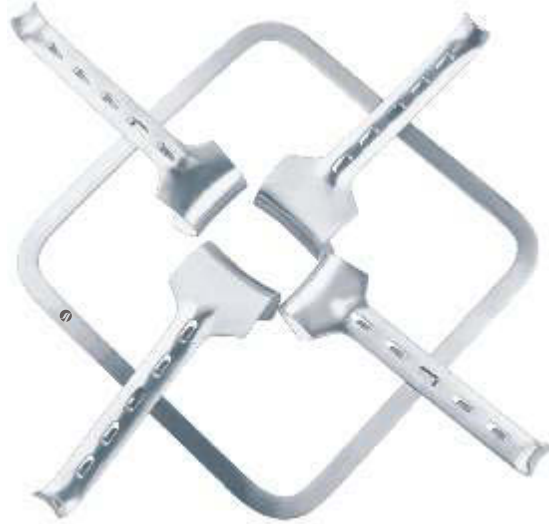

Catalog #	Size
RT-924-00	Standard

**Kirschner Frame only**



Catalog #	Frame Size
RT-924-24	240 x 240 mm

**Dennis-Browne Retractor Complete**

With Frame RT-930-15 & 2 Blades Each Ref:- RT-930-30  
and RT-930-40



Catalog #	Size
RT-930-00	Standard





Abdominal Retractors, Wound Spreaders, self-retaining  
Bauchdeckenhalter, Wundspreizer  
Separadores abdominales, Separadores autoestáticos  
Ecarteurs abdominaux, Ecarteurs autostatiques  
Divaricatori addominali, Divaricatori autostatici

**Dennis-Browne Retractor Frame Only**

Catalog #	Frame Size
RT-930-15	175 mm x 150 mm



**Dennis-Browne Retractor Blade Only**

Catalog #	Blade Size
RT-930-30	40 mm x 30 mm
RT-930-40	40 mm x 40 mm



**Cloward Retractor Complete**

With 2 Each Lateral Blades Ref:- RT-941-40  
and RT-941-60

Catalog #	Size
RT-940-00	Standard



**Cloward Retractor Only**

Catalog #	Size
RT-940-01	25 cm (9 3/4")







Wound Spreaders, self-retaining  
Wundspreizer  
Separadores autoestáticos  
Ecarteurs autostatiques  
Divaricatori autostatici

**Cloward Lateral Blade**  
Toothed

Catalog #	Blade Depth
RT-941-40	40 mm
RT-941-45	45 mm
RT-941-50	50 mm
RT-941-55	55 mm
RT-941-60	60 mm



**Cloward Retractor Complete**  
Complete with 2 Lateral Blades RT-945-40 and RT-945-60

Catalog #	Size
RT-944-00	Standard



**Cloward Retractor Frame Only**

Catalog #	Size
RT-944-01	15 cm (6")



**Cloward Lateral Blade**

Catalog #	Blade Depth
RT-945-40	40 mm
RT-945-45	45 mm
RT-945-50	50 mm
RT-945-55	55 mm
RT-945-60	60 mm





Laminectomy Retractors  
Laminektomiesperrer  
Separadores para laminectomia  
Ecarteurs pour laminectomie  
Divaricatori per laminectomia

**Scoville Retractor Complete**

With Lateral Blades Ref:- RT-953-06 and RT-953-11



Catalog #	Size
RT-950-00	Standard

**Scoville Frame Only**



Catalog #	Spead
RT-950-01	150 mm

**Scoville-Haverfield Retractor Complete**

With Lateral Blades Ref:- RT-953-06 and RT-953-11



Catalog #	Size
RT-952-00	Standard



Laminectomy Retractors  
Laminektomiesperrer  
Separadores para laminectomia  
Ecarteurs pour laminectomie  
Divaricatori per laminectomia

**Scoville-Haverfield Retractor Frame Only**  
Hinged

Catalog #	Spread
RT-952-01	150 mm



**Scoville Lateral Blade**  
Blunt

Catalog #	Blade Size
RT-953-01	50 mm
RT-953-02	70 mm



**Scoville Lateral Blade**  
Sharp

Catalog #	Blade Size
RT-953-06	50 mm
RT-953-07	70 mm



**Scoville Lateral Blade**  
Toothed

Catalog #	Blade Size
RT-953-11	60 x 25 mm
RT-953-12	64 x 50 mm
RT-953-13	88 x 25 mm





Laminectomy Retractors  
Laminektomiesperrer  
Separadores para laminectomia  
Ecarteurs pour laminectomie  
Divaricatori per laminectomia

**Taylor Lateral Blade**  
Sharp

Catalog #	Blade Size
RT-953-41	48 x 50 mm
RT-953-42	60 x 50 mm
RT-953-43	64 x 64 mm
RT-953-44	80 x 57 mm



**Scoville Lateral Blade**  
Sharp

Catalog #	Blade Size
RT-953-46	41 x 38 mm
RT-953-47	80 x 57 mm



**Scoville-Richter Retractor Complete**  
With Lateral Blades Pair Ref:- RT-957-01

Catalog #	Size
RT-956-00	Standard



**Scoville-Richter Frame Only**

Catalog #	Spead
RT-956-01	155 mm





Laminectomy Retractors  
Laminektomiesperrer  
Separadores para laminectomia  
Ecarteurs pour laminectomie  
Divaricatori per laminectomia

**Lateral Blade Pair**

Catalog #	Blade Sizes
RT-957-01	62 x 52 mm, 62 x 37 mm



**Lateral Blade**

Catalog #	Blade Sizes
RT-957-02	47 x 51 mm
RT-957-03	30 x 40 mm
RT-957-04	37 x 62 mm



RT-957-02



RT-957-03



RT-957-04

**Caspar Retractor Complete**

Catalog #	Size
RT-960-00	Standard



**Caspar Retractor Only**

With Key Ref: RT-960-02

Catalog #	Size
RT-960-01	Standard





Laminectomy Retractors  
Laminektomiesperrer  
Separadores para laminectomia  
Ecarteurs pour laminectomie  
Divaricatori per laminectomia

### Key for Caspar Retractor



Catalog #	Size
RT-960-02	Standard

### Caspar Hook



Catalog #	Depth
RT-961-01	38 mm
RT-961-02	58 mm

### Caspar Lateral Blade Blade With 2 Prongs

Catalog #	Blade Size
RT-961-03	32 x 22 mm
RT-961-04	37 x 22 mm
RT-961-05	42 x 22 mm
RT-961-06	47 x 22 mm
RT-961-07	52 x 22 mm
RT-961-08	57 x 22 mm
RT-961-09	62 x 22 mm
RT-961-10	67 x 22 mm





Laminectomy Retractors  
Laminektomiesperrer  
Separadores para laminectomia  
Ecarteurs pour laminectomie  
Divaricatori per laminectomia

**Caspar Lateral Blade**  
Blade With 3 Prongs

Catalog #	Blade Size
RT-961-11	32 x 37 mm
RT-961-12	37 x 37 mm
RT-961-13	42 x 37 mm
RT-961-14	47 x 37 mm
RT-961-15	52 x 37 mm
RT-961-16	57 x 37 mm
RT-961-17	62 x 37 mm
RT-961-18	67 x 37 mm



**Caspar Lateral Blade**  
Blade With 4 Prongs

Catalog #	Blade Size
RT-961-19	38 x 37 mm
RT-961-20	37 x 37 mm
RT-961-21	42 x 37 mm
RT-961-22	47 x 37 mm
RT-961-23	52 x 37 mm
RT-961-24	57 x 37 mm
RT-961-25	62 x 37 mm
RT-961-26	67 x 37 mm



**Cloward Lamina Spreader**



Catalog #	Size
RT-973-16	16 cm (6 1/4")



Laminectomy Retractors  
Laminektomiesperrer  
Separadores para laminectomia  
Ecarteurs pour laminectomie  
Divaricatori per laminectomia

### Cloward Lamina Spreader



Catalog #	Size
RT-975-13	13.5 cm (5 1/4")

### Inge Lamina Spreader



Catalog #	Size
RT-977-17	16 cm (6 1/4")
RT-979-27	25.5 cm (10")





**SURTEX**  
INSTRUMENTS

*Crafted to Excellence*

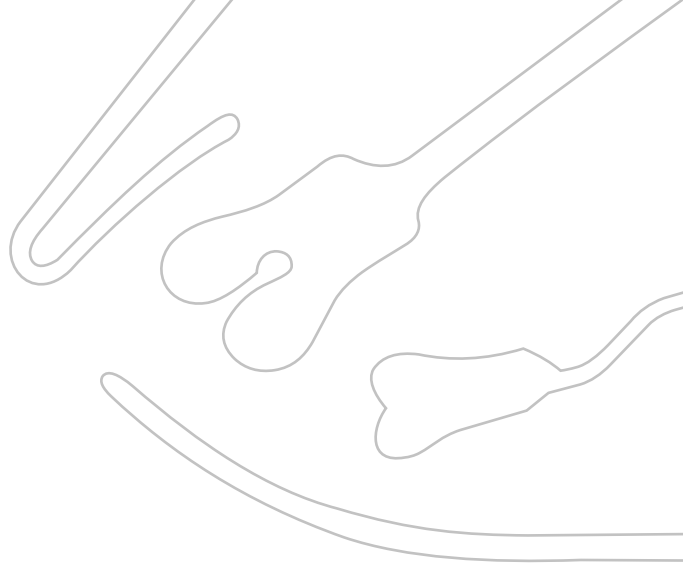

PR



## PROBES, COTTON APPLICATORS, SPATULAS

Surtex Instrument probes are made to exacting standards and ideal for exploring wounds or body cavities and passages. Our precision-engineered cotton applicators fulfill a variety of applications whether it is to take samples of substances such as tissue from within the body or to apply medication to areas, which have been wounded. Surtex cotton applicators always ensure that you have the right tool at hand to meet your objective.

Sonden, Watteträger, Spatel

Sondas, Porta-algodones, Espátulas

Sondes, porte-coton, Spatules

Sonde, Portacotoni, spatole



Probes  
Knopfsonden  
Sondas abotonadas  
Sondes boutonées  
Sonde a bottone

**Probe**

---

Catalog #	Size, Tip Diameter
PR-010-11	11.5 cm (4 1/2"), Ø 1 mm
PR-010-13	13 cm (5"), Ø 1 mm
PR-010-14	14.5 cm (5 3/4"), Ø 1 mm
PR-010-16	16 cm (6 1/4"), Ø 1 mm
PR-010-18	18 cm (7"), Ø 1 mm
PR-010-20	20 cm (8"), Ø 1 mm

---

**Probe**

---

Catalog #	Size
PR-015-11	11.5 cm (4 1/2"), Ø 1.5 mm
PR-015-13	13 cm (5"), Ø 1.5 mm
PR-015-14	14.5 cm (5 3/4"), Ø 1.5 mm
PR-015-16	16 cm (6 1/4"), Ø 1.5 mm
PR-015-18	18 cm (7"), Ø 1.5 mm
PR-015-20	20 cm (8"), Ø 1.5 mm

---

**Probe**

---

Catalog #	Size, Tip Diameter
PR-020-11	11.5 cm (4 1/2"), Ø 2 mm
PR-020-13	13 cm (5"), Ø 2 mm
PR-020-14	14.5 cm (5 3/4"), Ø 2 mm
PR-020-16	16 cm (6 1/4"), Ø 2 mm
PR-020-18	18 cm (7"), Ø 2 mm
PR-020-20	20 cm (8"), Ø 2 mm
PR-020-25	25 cm (9 3/4"), Ø 2 mm
PR-020-30	30 cm (11 3/4"), Ø 2 mm

---



Probes  
Knopfsonden  
Sondas abotonadas  
Sondes boutonnées  
Sonde a bottone

**Probe**  
With Eye



Catalog #	Size, Tip Diameter
PR-030-13	13 cm (5"), Ø 2 mm
PR-030-14	14.5 cm (5 ¾"), Ø 2 mm
PR-030-16	16 cm (6 ¼"), Ø 2 mm

**Stacke (Silver) Probe**



Catalog #	Size, Tip Diameter
PR-040-10	10 cm (4"), Ø 1 mm

**Cawthorne Probe**  
Flattened End



Catalog #	Size
PR-050-10	14 cm (5 ½")

**Myrtle Leaf Probe**



Catalog #	Size, Tip Diameter
PR-070-13	13 cm (5"), Ø 2 mm
PR-070-14	14.5 cm (5 ¾"), Ø 2 mm
PR-070-16	16 cm (6 ¼"), Ø 2 mm
PR-070-18	18 cm (7"), Ø 2 mm
PR-070-20	20 cm (8"), Ø 2 mm



Probes, Grooved Directors  
Knopfsonden, Hohlsonden  
Sondas abotonadas, Sondas acanaladas  
Sondes boutonnées, Sondes cannelées  
Sonde a bottone, Sonde cannellate

**Killian Probe**



Catalog #	Size
PR-081-16	16.5 cm (6 1/2")

**Probe**



Catalog #	Size
PR-083-16	16 cm (6 1/4")

**Ochsner Gall Stone Probe**  
Malleable



Catalog #	Size
PR-086-35	35 cm (13 3/4")

**Mayo Common Duct Probe**  
Malleable



Catalog #	Size, Tip Size
PR-088-05	25.5 cm (10"), 5 mm
PR-088-06	25.5 cm (10"), 6 mm

**Seiffert Probe**



Catalog #	Size
PR-091-19	19.5 cm (7 3/4")



Probes, Grooved Directors  
Knopfsonden, Hohlsonden  
Sondas abotonadas, Sondas acanaladas  
Sondes boutonnées, Sondes cannelées  
Sonde a bottone, Sonde cannellate

**Butterfly Probe / Grooved Director**

Catalog #	Size
PR-100-13	13 cm (5")
PR-100-14	14 cm (5 1/2")
PR-100-16	16 cm (6 1/4")



**Butterfly Probe / Grooved Director  
With Tip**

Catalog #	Size
PR-120-13	13 cm (5")
PR-120-14	14.5 cm (5 3/4")
PR-120-16	16 cm (6 1/4")



**Doyen Butterfly Probe / Grooved Director**

Catalog #	Size
PR-131-14	14.5 cm (5 3/4")



**Nelaton Butterfly Probe / Grooved Director**

Catalog #	Size
PR-141-16	16 cm (6 1/4")



**Brodie Butterfly Probe / Grooved Director**

Catalog #	Size, Tip Diameter
PR-150-20	20 cm (8"), Ø 3.5 mm





Fistula Probes  
Fistelsonden  
Sondas para fistula  
Sondes pour fistule  
Sonde per fistole

**Bowman Probes Complete**  
Set of 6 Probes

Catalog #	Size
PR-200-00	Standard



**Bowman Probes**

Catalog #	Size, Profile
PR-202-00	13 cm (5"), Fig. 0000/000
PR-204-00	13 cm (5"), Fig. 00/0
PR-204-12	13 cm (5"), Fig. 1/2
PR-204-34	13 cm (5"), Fig. 3/4
PR-204-56	13 cm (5"), Fig. 5/6
PR-204-78	13 cm (5"), Fig. 7/8



**Lockhart-Mummery Fistula Probe**  
Fig. 1

Catalog #	Size
PR-250-01	16.5 cm (6 1/2")



**Lockhart-Mummery Fistula Probe**  
Fig. 2

Catalog #	Size
PR-251-02	16.5 cm (6 1/2")



**Lockhart-Mummery Fistula Probe**  
Fig. 3

Catalog #	Size
PR-251-03	16.5 cm (6 1/2")





**Lockhart-Mummery Fistula Probe**  
Fig. 4



Catalog #	Size
PR-251-04	16.5 cm (6 1/2")

**Pratt Fistula Probe**  
Fig. 1



Catalog #	Size, Profile
PR-261-01	21 cm (8 1/4"), Fig. 1
PR-261-02	21 cm (8 1/4"), Fig. 2
PR-261-03	21 cm (8 1/4"), Fig. 3

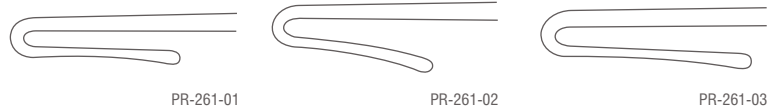

**Nabatoff Varicose Vein Probes Complete Set**

Catalog #	Size
PR-300-00	Standard



**Nabatoff Vein Probe**  
Plastic Tip

Catalog #	Size
PR-300-02	Standard



**Nabatoff Vein Probe**  
Olive Shaped

Catalog #	Tip Diameter
PR-300-03	Ø 3 mm
PR-300-06	Ø 6 mm
PR-300-09	Ø 9 mm
PR-300-12	Ø 12 mm
PR-300-15	Ø 15 mm

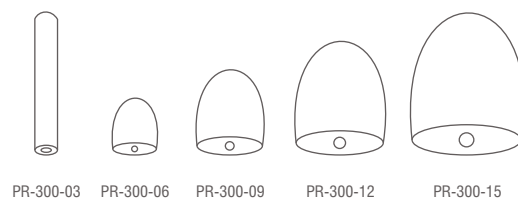



Ring Strippers  
Ringstripper  
Fleboextractores  
Strippers à anneau  
Stripper anello

**Nabatoff T Shaped Handle**

Catalog #	Size
PR-300-80	Standard

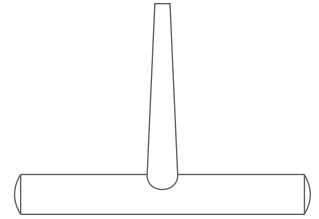

**Nabatoff Traction Cable**

Catalog #	Size
PR-300-90	Standard

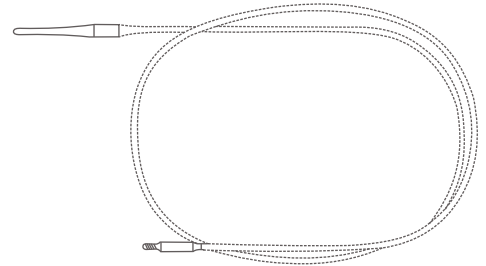

**Vollmar Ring Strippers Complete Set**

Catalog #	Size
PR-400-00	Standard

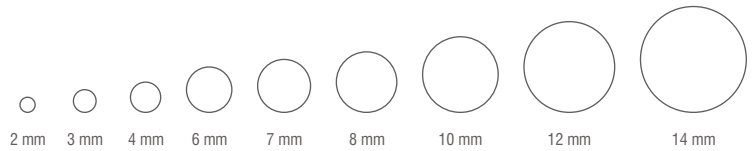

**Handle For Vollmar Strippers**

Catalog #	Size
PR-400-01	11.5 cm (4 1/2")







Cotton Applicators, Varix Instruments  
Watteträger, Varizeninstrumente  
Porta algodones, Instrumentos para varices  
Porte-cotons, Instruments pour varices  
Portacotrone, Strumenti per varici

**Vollmar Ring Stripper**

Catalog #	Size, Ring Diameter
PR-401-02	50 cm (19 3/4"), Ø 2 mm
PR-401-03	50 cm (19 3/4"), Ø 3 mm
PR-401-04	50 cm (19 3/4"), Ø 4 mm
PR-401-06	50 cm (19 3/4"), Ø 6 mm
PR-401-07	50 cm (19 3/4"), Ø 7 mm
PR-401-08	50 cm (19 3/4"), Ø 8 mm
PR-401-10	50 cm (19 3/4"), Ø 10 mm
PR-401-12	50 cm (19 3/4"), Ø 12 mm
PR-401-14	50 cm (19 3/4"), Ø 14 mm

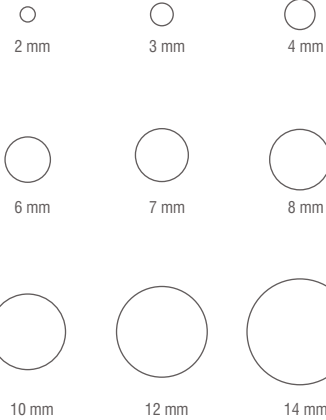

**Farrell Cotton Applicator**  
Round Spiral End

Catalog #	Size, Working End Diameter
PR-500-12	12 cm (4 3/4"), Ø 0.9 mm
PR-500-14	14 cm (5 1/2"), Ø 0.9 mm
PR-500-16	16 cm (6 1/4"), Ø 1.1 mm
PR-500-18	18 cm (7"), Ø 1.2 mm



**Farrell Cotton Applicator**  
Triangular Shaped End

Catalog #	Size, Working End Diameter
PR-520-12	12 cm (4 3/4"), Ø 0.9 mm
PR-520-14	14 cm (5 1/2"), Ø 0.9 mm
PR-520-16	16 cm (6 1/4"), Ø 1.1 mm
PR-520-18	18 cm (7"), Ø 1.2 mm





Varix Instruments  
Varizeninstrumente  
Instrumentos para varices  
Instruments pour varices  
Strumenti per varici

**Cotton Application**  
Round Spiral End End



Catalog #	Size, Working End Diameter
PR-540-15	18 cm (7"), Ø 1.5 mm
PR-540-18	18 cm (7"), Ø 1.8 mm

**Hartmann Cotton Application**  
Round Spiral End



Catalog #	Size, Working End Diameter
PR-551-22	22 cm (8 1/2"), Ø 2.3 mm

**Jobson-Horne Ear Probe**  
Double Ended



Catalog #	Size
PR-561-15	15 cm (6")

**Varady Varix Instrument**  
Phlebodissector



Catalog #	Size
PR-600-01	18 cm (7")
PR-600-02	18 cm (7")
PR-600-03	18 cm (7")

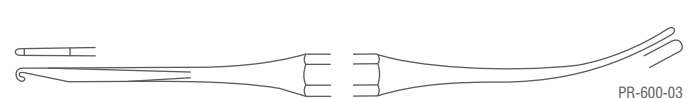
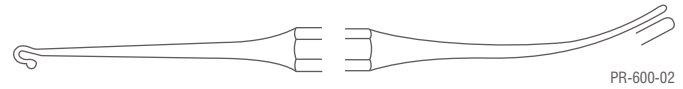
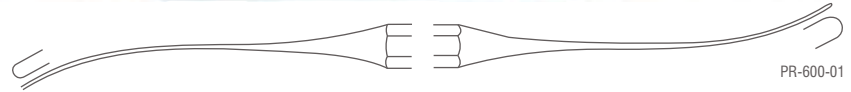

**Varady Varix Instrument**  
Micro Dissector

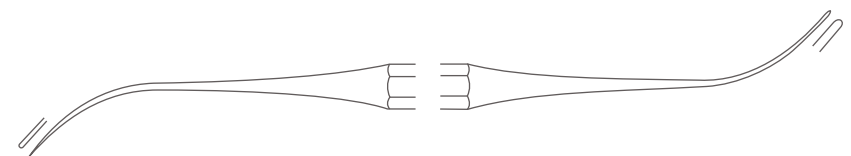

Catalog #	Size
PR-600-04	17.5 cm (7")





**Varady Varix Instrument**  
Micro Phlebodissector

Catalog #	Size
PR-600-05	18 cm (7")

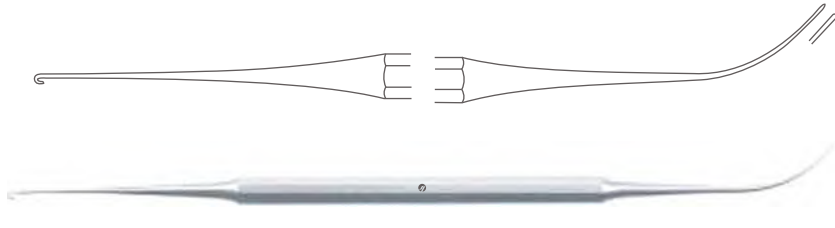

**Varady Varix Instrument**  
Mini Phlebodissector

Catalog #	Size
PR-600-06	18 cm (7")

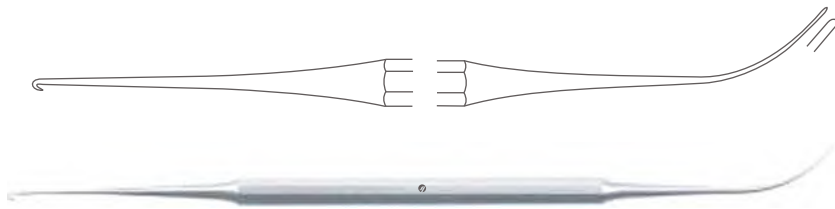





**SURTEX**  
INSTRUMENTS

*Crafted to Excellence*

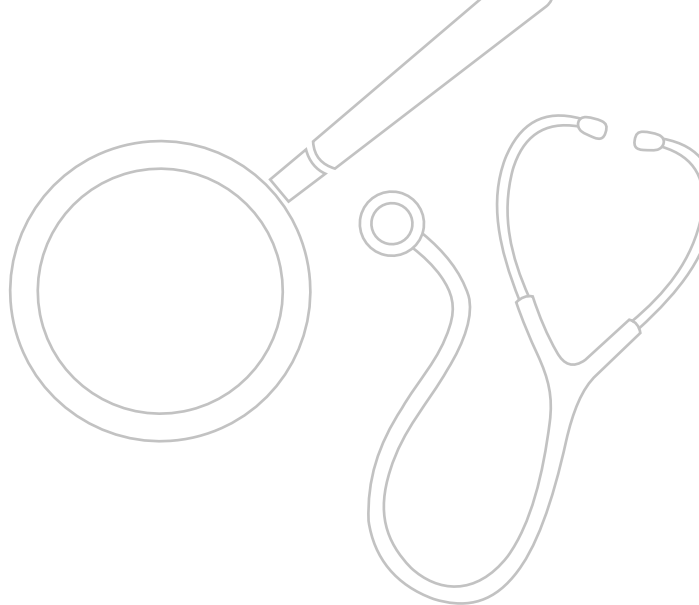

DI



## DIAGNOSTIC

State of the art manufacturing techniques, high-grade materials and a constant focus on innovation is the secret behind Surtex Diagnostic product range.

Our Oscopes guarantee excellent image quality with uniquely bright and reflex-free illumination of the tympanum and auditory canal. Our **Corona**™ Premium Oscope features distal fiber optic (F.O.) for bright illumination and maximum vision and are also available in **pollo** Standard featuring direct bulb illumination utilizing Surtex xenon illuminated bulbs.

Ophthalmoscope allows a medical professional to obtain visual access to a portion of the eye known as the fundus. This is the only portion of the eyes in which arteries, veins and nerves can be seen without surgical intervention. At Surtex we realize that a good view of the fundus is vital to assess not only health of the eye but also the overall patient health. Our **Corona**™ Premium Ophthalmoscope set the industry standard for optical quality and diagnostic accuracy and features distal fiber optic (F.O.) for bright illumination and maximum vision and are also available in **pollo** Standard featuring direct bulb illumination utilizing Surtex xenon illuminated bulbs.

Surtex offers a complete range to cover practically all-surgical requirements, whether an application only needs just a basic ruler or a Jameson caliper, with tolerances so tight as to demand the most accurate and highest resolution.

Each product component is designed using the latest CAD techniques to ensure maximum performance and manufactured from materials best suited to the purpose for guaranteed longevity.

Diagnostik

Diagnóstico

Diagnostic

Diagnostica



Percussion Hammers  
Perkussionshämmer  
Martillos para reflejos  
Marteaux-percuteurs  
Martelli percussori

**Buck Percussion Hammer**  
With Needle and Brush

Catalog #	Size
DI-100-18	18.5 cm (7 1/4")



**Dejerine Percussion Hammer**

Catalog #	Size
DI-110-20	20 cm (8")



**Dejerine Percussion Hammer**  
With Needle

Catalog #	Size
DI-112-21	21 cm (8 1/4")



**Taylor Mod. USA Percussion Hammer**

Catalog #	Size
DI-120-20	20 cm (8")



**Babinsky Percussion Hammer**  
With Needle

Catalog #	Size
DI-130-22	22 cm (8 3/4")





Percussion Hammers, Stethoscopes  
Perkussionshämmer, Stethoskope  
Martillos para reflejos, Estetoscopios  
Marteaux-percuteurs, Stéthoscopes  
Martelli percussori, Stetoscopi

**Rabiner Percussion Hammer**



Catalog #	Size
DI-132-23	23 cm (9")

**Wartenberg Sensibility Instrument**



Catalog #	Size
DI-210-19	19 cm (7 1/2")

**Pinard Stethoscope**  
Wood



Catalog #	Size
DI-300-18	18 cm (7")

**Pinard Stethoscope**  
Aluminium



Catalog #	Size
DI-310-15	15 cm (6")

**Duplex-Baby Stethoscope**  
Super Light Weight



Catalog #	Chest Piece Diameter
DI-350-00	Ø 37 mm



Stethoscopes, Blood Pressure Manometers  
Stethoskope, Blutdruckmessgeräte  
Estetoscopios, Manómetros  
Stéthoscopes, Tonomètres  
Stetoscopi, Sfigmomanometri

**Duplex Stethoscope**  
Super Light Weight

Catalog #	Chest Piece Diameter
DI-380-00	Ø 47 mm



**Anaestophon Stethoscope**  
Super Light Weight

Catalog #	Chest Piece Diameter
DI-390-00	Ø 47 mm



**Diplomat Manometer**  
With Velcro Cuff

Catalog #	Size
DI-500-00	Standard



**Manometer**  
With Velcro Cuff

Catalog #	Size
DI-520-00	Standard



**Manometer**  
Wall Mounted

Catalog #	Size
DI-550-00	Standard

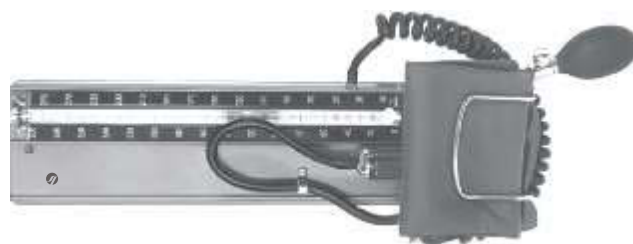





Head Mirrors, Head Lamps  
Stirnspiegel, Stirnlampen  
Espejos frontales, Lámparas frontales  
Miroirs frontaux, Eclaireurs frontaux  
Specchio frontale, Lampada frontale

**Pressofix Tourniquet**

Catalog #	Width
DI-585-00	30 mm



**Ziegler Head Mirror**  
Without Protection Cap

Catalog #	Diameter
DI-600-09	Ø 90 mm



**Ziegler Head Mirror**  
With Protection Cap

Catalog #	Diameter
DI-601-09	Ø 90 mm



**Clar Head Light Complete**  
With Transformer

Catalog #	Diameter, Power Source
DI-611-06	Ø 55 mm, 6 Volts



**Clar Head Light Complete**  
With Transformer

Catalog #	Diameter, Power Source
DI-615-06	Ø 100 mm, 6 Volts





Head Lamps, Magnifying Glass  
Stirnlampen, Stiiellupen  
Lámparas frontales, Lupas  
Eclaireurs frontaux, Loupes  
Lampada frontale, Lenti d`ingrandimento

**Head Light**  
Xenon Light

Catalog #	Size
DI-651-06	Standard



**Magnifying Glass**  
Bi-Convex, Metal Handle

Catalog #	Magnification, Glass Diameter
DI-670-50	2.5 x, 50 mm Ø



**Magnifying Glass**  
Bi-Convex, Plastic Handle

Catalog #	Magnification, Glass Diameter
DI-672-75	2.5 x, 75 mm Ø



**Operating Loupe**

Catalog #	Magnification, Working Distance
DI-680-00	2.3 x, 340 mm



**Operating Loupe**

Catalog #	Magnification, Working Distance
DI-690-00	1.8 x, 400 mm





Diagnostic Set  
Diagnostikbesteck  
Juego para Diagnóstico  
Jeu pour diagnostic  
Set per diagnostica

**Corona™ Premium EENT Diagnostic Set**



Catalog #	Size
DI-730-00	Standard



**Corona™ Premium Otoscope**



Catalog #	Size
DI-732-00	Standard



**Corona™ Premium Ophthalmoscope**



Catalog #	Size
DI-734-00	Standard



**Apollo™ Standard Universal EENT Diagnostic Set**



Catalog #	Size
DI-740-00	Standard





Diagnostic Set, Calipers  
Diagnostikbesteck, Meßzirkel  
Juego para Diagnóstico, Compases  
Jeu pour diagnostic, Compas  
Set per diagnostica, Compassi

**Apollo™ Standard Otoscope**



Catalog #	Size
DI-742-00	Standard

**Apollo™ Standard Ophthalmoscope**



Catalog #	Size
DI-744-00	Standard

**Apollo™ Standard Dermatoscope**



Catalog #	Size
DI-750-00	Standard

**Jameson Caliper**



Catalog #	Size
DI-801-00	Standard

**Carroll Finger Goniometer**



Catalog #	Size
DI-803-14	14.5 cm (5 3/4")



Calipers, Dynamometers, Flexometer  
Schieblehren, Dynamometer, Winkelmesser  
Calibres, Dinamómetros, Goniómetro  
Pieds à coulisse, Dynamomètres, Goniomètres  
Calibro, Dinamometro, Goniometro

**Townley Caliper**

Graduated in mm and inches



Catalog #	Size
DI-805-11	11.5 cm (4 1/2")

**Collin Dynamometer**

Graduated in KG, For Adults



Catalog #	Size
DI-810-11	11 cm (4 1/4")

**Collin Dynamometer**

Graduated in Lbs, For Adults



Catalog #	Size
DI-812-11	11 cm (4 1/4")

**Moeltgen Flexometer**

For Extremities



Catalog #	Size
DI-820-00	Standard

**Vernier Caliper**

Graduated in mm and inches



Catalog #	Size, Measuring Range
DI-831-03	23.5 cm (9 1/4"), 150 mm



Calipers  
Schieblehren  
Calibres  
Pieds à coulisse  
Calibro

**Vernier Caliper**

Graduated in mm and inches

Catalog #	Size, Measuring Range
DI-833-22	22.5 cm (8 3/4"), 145 mm



**Boley Caliper**

Catalog #	Measuring Range
DI-841-00	100 mm



**Measuring Caliper**

Catalog #	Measuring Range
DI-845-00	100 mm



**Castroviejo Caliper  
Straight**

Catalog #	Size, Measuring Range
DI-850-15	8 cm (3"), 15 mm
DI-850-20	8 cm (3"), 20 mm



**Castroviejo-Epker Caliper**

Catalog #	Size, Measuring Range
DI-851-20	8 cm (3"), 20 mm





Calipers, Rulers  
Schieblehren, Maßstäbe  
Calibres, Reglas  
Pieds à coulisse, Règles à mesurer  
Calibro, Misuratori

**Castroviejo Caliper**  
Curved

Catalog #	Size, Measuring Range
DI-852-09	9 cm (3 1/2"), 40 mm
DI-852-18	18 cm (7"), 40 mm



**Iwanson Caliper**

Catalog #	Size, Measuring Range
DI-860-10	10 cm (4"), 10 mm



**Ruler**  
Graduated in mm and inches

Catalog #	Size, Measuring Range
DI-880-15	10 cm (4"), 150 mm
DI-880-20	22 cm (8 3/4"), 200 mm
DI-880-30	31.5 cm (12 1/2"), 300 mm
DI-880-50	52.5 cm (20 3/4"), 500 mm



**Ruler**  
For X-Ray

Catalog #	Size, Measuring Range
DI-884-50	52.5 cm (20 3/4"), 500mm



**Measuring Tape**  
Graduated in cm and inches

Catalog #	Size
DI-890-15	150 cm (59")









**SURTEX**  
INSTRUMENTS

*Crafted to Excellence*

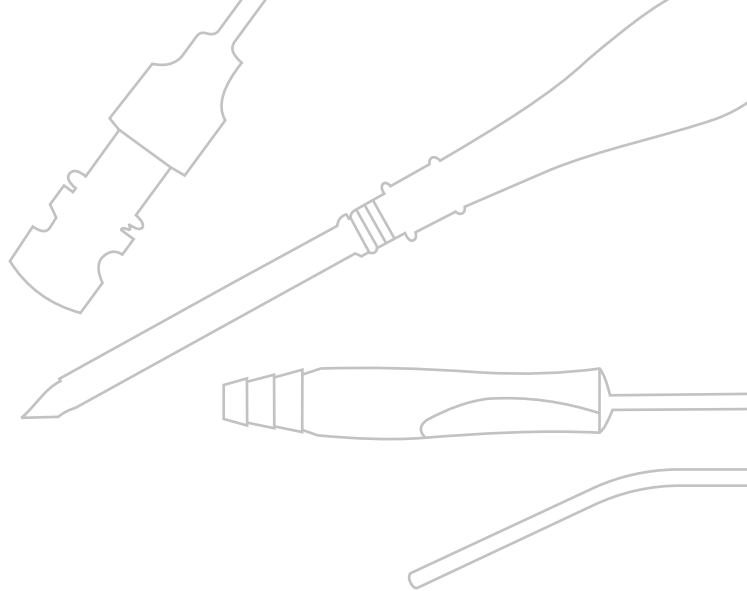

TR



## TROCARS, SUCTION TUBES, CANNULAS

Surtext Trocars, Suction Instruments and Needles feature a lightweight, low profile and ergonomic design that provide hospitals with a cost effective alternative to disposable trocars. Special focus and precision is used on the tips to help placement by clinicians to minimize the risk of trocar injuries during puncturing and effortlessly enable withdrawal of fluid from the body cavity.

In this section you will find a comprehensive range including but not limited to suction tubes, hypodermic needles, vessel irrigation cannulas, special needles and guide needles.

Trokare, Saugrohre, Kanülen

Trócares, Tubos de Aspiración, Cánulas

Trocarts, Tubes d'aspiration, Canules

Trequarti, Tubi d'aspirazione, Cannule



Trocars  
Trokare  
Trócares  
Trocarts  
Trequarti

**Universal Trocar**

With 4 Trocar Tips Diameter 1.7 mm, 3.0 mm, 4.5 mm and 6.0 mm



Catalog #	Size
TR-010-00	14.5 cm (5 3/4")

**Nelson Trocar**

22 FG, Fig. 1



Catalog #	Size
TR-020-07	20 cm (8"), Ø 7.5 mm - 22 Charr.
TR-020-09	20 cm (8"), Ø 9.5 mm - 28 Charr.
TR-020-11	20 cm (8"), Ø 11.0 mm - 33 Charr.

**Ochsner Trocar**

Catalog #	Size, Tip Diameter
TR-030-01	14 cm (5 1/2"), Ø 4 mm
TR-030-02	14 cm (5 1/2"), Ø 4.6 mm
TR-030-03	14 cm (5 1/2"), Ø 5.3 mm
TR-030-04	14 cm (5 1/2"), Ø 6.0 mm
TR-030-05	14 cm (5 1/2"), Ø 6.6 mm
TR-030-06	14 cm (5 1/2"), Ø 7.3 mm
TR-030-07	14 cm (5 1/2"), Ø 8.0 mm
TR-030-08	14 cm (5 1/2"), Ø 8.6 mm



**Suction Tube**

Catalog #	Size, Tip Diameter
TR-051-14	14 cm (5 1/2"), Ø 1.5 mm
TR-051-18	18 cm (7"), Ø 1.5 mm





Suction Cannulas  
Saugrohre  
Tubos de aspiración  
Tubes d'aspiration  
Tubi d'aspirazione

**Suction Tube**

Catalog #	Size, Tip Diameter
TR-053-14	14 cm (5 1/2"), Ø 2.5 mm
TR-053-18	18 cm (7"), Ø 2.5 mm



**Suction Tube**

Catalog #	Size, Tip Diameter
TR-055-14	14 cm (5 1/2"), Ø 3.0 mm
TR-055-18	18 cm (7"), Ø 3.0 mm



**Suction Tube**

Catalog #	Size, Tip Diameter
TR-057-14	14 cm (5 1/2"), Ø 4.0 mm
TR-057-18	18 cm (7"), Ø 4.0 mm



**Suction Tube**

Catalog #	Size, Tip Diameter
TR-059-14	14 cm (5 1/2"), Ø 6.0 mm
TR-059-18	18 cm (7"), Ø 6.0 mm





Suction Cannulas  
Saugrohre  
Tubos de aspiración  
Tubes d'aspiration  
Tubi d'aspirazione

**Adson Suction Tube**  
12 Charr.



Catalog #	Size, Diameter
TR-091-20	20 cm (8"), Ø 4.0 mm

**Frazier Suction Tube**



Catalog #	Size, Diameter
TR-094-24	24 cm (9 1/2"), Ø 3.3 mm - 10 Charr.

**Frazier Suction Tube**



Catalog #	Size, Diameter
TR-101-06	19.5 cm (7 3/4"), Ø 2.0 mm - 6 Charr.
TR-101-07	19.5 cm (7 3/4"), Ø 2.3 mm - 7 Charr.
TR-101-08	19.5 cm (7 3/4"), Ø 2.7 mm - 8 Charr.
TR-101-09	19.5 cm (7 3/4"), Ø 3.0 mm - 9 Charr.
TR-101-10	19.5 cm (7 3/4"), Ø 3.3 mm - 10 Charr.
TR-101-11	19.5 cm (7 3/4"), Ø 3.6 mm - 11 Charr.
TR-101-12	19.5 cm (7 3/4"), Ø 4.0 mm - 12 Charr.
TR-101-13	19.5 cm (7 3/4"), Ø 5.0 mm - 15 Charr.

**Fergusson Suction Tube**



Catalog #	Size, Diameter
TR-111-05	18 cm (7"), Ø 1.7 mm - 5 Charr.
TR-111-06	18 cm (7"), Ø 2.0 mm - 6 Charr.
TR-111-08	18 cm (7"), Ø 2.5 mm - 8 Charr.
TR-111-09	18 cm (7"), Ø 3.0 mm - 9 Charr.
TR-111-12	18 cm (7"), Ø 4.0 mm - 12 Charr.
TR-111-13	18 cm (7"), Ø 5.0 mm - 15 Charr.



Suction Cannulas  
Saugrohre  
Tubos de aspiración  
Tubes d'aspiration  
Tubi d'aspirazione

**Zoellner Suction Tube Complete**

Catalog #	Size
TR-131-00	N/A



**Zoellner Suction Handle Only**

Catalog #	Size
TR-131-01	N/A



**Zoellner Suction Tip Only**

Catalog #	Diameter
TR-132-05	Ø 0.5 mm
TR-132-07	Ø 0.7 mm
TR-132-09	Ø 0.9 mm
TR-132-12	Ø 1.2 mm



**Wullstein Suction Tube Complete**

With Suction Handle and Micro Suction Tube Ref: TR-142-04, TR-142-06, TR-142-08

Catalog #	Size
TR-141-00	14 cm (5 ½")



**Wullstein Suction Handle Only**

Catalog #	Size
TR-141-01	14 cm (5 ½")





Suction Cannulas  
Saugrohre  
Tubos de aspiración  
Tubes d'aspiration  
Tubi d'aspirazione

**Wullstein Micro Suction Handle**

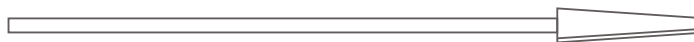

Catalog #	Size, Diameter
TR-142-04	4.5 cm (1 3/4"), Ø 0.4 mm
TR-142-06	4.5 cm (1 3/4"), Ø 0.6 mm
TR-142-08	4.5 cm (1 3/4"), Ø 0.8 mm

**Baron-Schuknecht Suction Handle**  
With Finger Cut Off



Catalog #	Working Length, Diameter
TR-151-10	Ø 75 mm, 1.0 mm
TR-151-15	Ø 75 mm, 1.5 mm
TR-151-20	Ø 75 mm, 2.0 mm

**House Suction Adapter**  
With Finger Cut Off



Catalog #	Size
TR-180-00	N/A

**Verhoeven Suction Cannula**  
With Luer Cone



Catalog #	Diameter
TR-185-05	Ø 0.5 mm
TR-185-07	Ø 0.7 mm
TR-185-10	Ø 1.0 mm
TR-185-12	Ø 1.2 mm
TR-185-15	Ø 1.5 mm



**House Suction Tube**  
With Finger Cutt Off



Catalog #	Suction Diameter, Irrigation Diameter
TR-191-09	Ø 0.9 mm, 0.7 mm
TR-191-12	Ø 1.2 mm, 0.9 mm
TR-191-15	Ø 1.5 mm, 1.2 mm

**Luer Suction Tube**



Catalog #	Working Length, Diameter
TR-201-30	Ø 110 mm, 3.0 mm
TR-201-35	Ø 110 mm, 3.5 mm
TR-201-45	Ø 110 mm, 4.5 mm

**Yasargil Suction Tube**  
With Luer Hub



Catalog #	Working Length, Diameter
TR-221-15	Ø 130 mm, 1.5 mm
TR-221-20	Ø 130 mm, 2.0 mm
TR-221-25	Ø 130 mm, 2.5 mm
TR-221-35	Ø 130 mm, 3.5 mm

**Yasargil Suction Tube**  
With Luer Hub



Catalog #	Working Length, Diameter
TR-223-15	Ø 150 mm, 1.5 mm
TR-223-20	Ø 150 mm, 2.0 mm
TR-223-25	Ø 150 mm, 2.5 mm
TR-223-35	Ø 150 mm, 3.5 mm



Suction Tubes  
Sauger  
Tubos de aspiración  
Tubes d'aspiration  
Tubi d'aspirazione

**Yasargil Suction Tube**  
With Luer Hub



Catalog #	Working Length, Diameter
TR-225-15	Ø 180 mm, 1.5 mm
TR-225-20	Ø 180 mm, 2.0 mm
TR-225-25	Ø 180 mm, 2.5 mm
TR-225-35	Ø 180 mm, 3.5 mm

**Yasargil Suction Tube**  
With Luer Hub



Catalog #	Working Length, Diameter
TR-227-15	Ø 220 mm, 1.5 mm
TR-227-20	Ø 220 mm, 2.0 mm
TR-227-25	Ø 220 mm, 2.5 mm
TR-227-35	Ø 220 mm, 3.5 mm

**Suction Raspatory**  
Sharp, Bayonet Shaped



Catalog #	Size, Width
TR-241-04	20 cm (8"), 4.0 mm
TR-241-05	20 cm (8"), 5.0 mm

**Landolt Dissecting Suction Tube**  
Sharp



Catalog #	Size, Width
TR-243-32	20 cm (8"), 3.2 mm





Suction Tubes  
Sauger  
Tubos de aspiración  
Tubes d'aspiration  
Tubi d'aspirazione

**Yankauer Suction Tube Complete**

Catalog #	Size
TR-251-27	31 cm (21 1/4")



**Yankauer Suction Tube Complete (Detachable)**  
With Handle, 4 Tube, Suction Tip and Tube Connector

Catalog #	Size
TR-255-00	31 cm (21 1/4")



**Yankauer Suction Handle Only**

Catalog #	Size
TR-255-01	15 cm (6")



**Yankauer Suction Connector Only**  
Oval Shaped

Catalog #	Size
TR-255-02	2.5 cm (1")



**Yankauer Suction Tube Only**

Catalog #	Size, Profile
TR-255-10	10 cm (4"), Fig. 0
TR-255-11	10 cm (4"), Fig. 1
TR-255-12	10 cm (4"), Fig. 2
TR-255-13	10 cm (4"), Fig. 3





Suction Tubes  
Sauger  
Tubos de aspiración  
Tubes d'aspiration  
Tubi d'aspirazione

**Yankauer Suction Tip**



Catalog #	Size
TR-255-15	N/A

**Poole Suction Tube**



Catalog #	Size, Diameter
TR-270-22	22 cm (8 3/4"), Ø 10.0 mm

**Poole Suction Tube**



Catalog #	Size, Diameter
TR-271-22	22.5 cm (8 3/4"), Ø 8.0 mm

**Poole-Baby Suction Tube**



Catalog #	Size, Diameter
TR-273-20	22 cm (8"), Ø 5.5 mm

**Coolley Suction Tube**



Catalog #	Size, Diameter
TR-281-35	36 cm (8 1/4"), Ø 8.0 mm



Suction Tubes  
Sauger  
Tubos de aspiración  
Tubes d'aspiration  
Tubi d'aspirazione

**Cooley Suction Tube**  
With Perforated Screw Tip



Catalog #	Size, Diameter
TR-283-31	31 cm (12 1/4"), Ø 10.0 mm

**Cooley Suction Tube**  
With Perforated Screw Tip



Catalog #	Size, Diameter
TR-285-30	31 cm (12 1/4"), Ø 7.0 mm

**Cooley Suction Tube**  
With Perforated Screw Tip



Catalog #	Size, Diameter
TR-287-33	36 cm (12 1/4"), Ø 8.0 mm

**DeBakey Suction Tube**



Catalog #	Size, Diameter
TR-291-27	27.5 cm (10 3/4"), Ø 9.0 mm

**Finsterer Suction Tube**



Catalog #	Size, Diameter
TR-301-32	32 cm (12 3/4"), Ø 15.0 mm



Suction Tubes  
Sauger  
Tubos de aspiración  
Tubes d'aspiration  
Tubi d'aspirazione

**Nuboer Suction Tube**  
Round Opening



Catalog #	Size, Diameter
TR-311-21	21 cm (8 1/4"), Ø 6.0 mm

**Nuboer Suction Tube**  
Oval Opening



Catalog #	Size, Diameter
TR-313-21	21 cm (8 1/4"), Ø 6.0 mm

**Coupland Suction Tube Complete**  
With Suction Tips Ref: TR-323-05 to TR-323-08



Catalog #	Size
TR-321-00	N/A

**Coupland Suction Handle**  
With Tube Connector



Catalog #	Size
TR-322-24	17 cm (6 3/4")

**Coupland Suction Tip**  
Laterally Perforated



Catalog #	Size, Diameter
TR-323-05	9 cm (3 1/2"), Ø 1.5 mm
TR-323-06	9 cm (3 1/2"), Ø 2.0 mm
TR-323-07	9 cm (3 1/2"), Ø 2.5 mm
TR-323-08	9 cm (3 1/2"), Ø 3.5 mm



Suction Tubes, Hypodermic Needles  
Sauger, Injektionskanülen  
Tubos de aspiración, Agujas hipodérmicas  
Tubes d'aspiration, Aiguilles hypodérmiques  
Tubi d'aspirazione, Cannule per iniezione

**Byrd Suction Tube**



Catalog #	Size, Diameter
TR-341-30	21.5 cm (8 1/2"), Ø 3.0 mm
TR-341-38	21.5 cm (8 1/2"), Ø 2.5 mm
TR-341-43	21.5 cm (8 1/2"), Ø 3.5 mm

**Cogswell Suction Tube**

With Finger Cutt Off



Catalog #	Size, Diameter
TR-345-23	24.5 cm (9 3/4"), Ø 2.0 mm

**Hypodermic Needle**

Set of 7 Ref: TR-602-01 Up to TR-602-20



Catalog #	Size, Diameter
TR-400-00	24.5 cm (9 3/4"), Ø 2.0 mm

**Hypodermic Needle**



Catalog #	Needle Size, Profile
TR-400-01	0.85 x 40 mm, Fig. 1
TR-400-02	0.80 x 35 mm, Fig. 2
TR-400-12	0.70 x 32 mm, Fig. 12
TR-400-14	0.65 x 30 mm, Fig. 14
TR-400-16	0.60 x 25 mm, Fig. 16
TR-400-18	0.50 x 23 mm, Fig. 18
TR-400-20	0.45 x 18 mm, Fig. 20



Special Needles  
Spezialkanülen  
Agujas especiales  
Aiguilles spéciales  
Aghi speciali

**Pudendus Anaesthesia Needle**  
Complete With Cannula



Catalog #	Size, Cannula Size
TR-410-00	18 cm (7"), Ø 1.0 x 185 mm

**Vein Cannula**  
Button End, With Tube Connector



Catalog #	Cannula Size
TR-420-12	Ø 1.2 x 80 mm
TR-420-15	Ø 1.5 x 80 mm

**Quinke Lumbar Puncture Needle**  
18 G, 19 G, 22 G, With Luer Lock Connection



Catalog #	Needle Size
TR-450-10	Ø 1.2 x 76 mm
TR-450-12	Ø 1.2 x 89 mm
TR-450-14	Ø 1.0 x 76 mm
TR-450-16	Ø 1.0 x 89 mm
TR-450-18	Ø 0.7 x 76 mm
TR-450-19	Ø 0.7 x 50 mm
TR-450-20	Ø 0.7 x 89 mm

**Tuohy Lumbar Puncture Needle**  
18 G, 17 G, 16 G, With Luer Lock Connection, Special Tip



Catalog #	Needle Size
TR-460-12	Ø 1.2 x 76 mm
TR-460-14	Ø 1.4 x 76 mm
TR-460-16	Ø 1.4 x 35 mm



**Menghini Liver Puncture Needle**  
Blind Lever Puncture, With Stopping Needle

Catalog #	Needle Size
TR-470-10	Ø 1.0 x 35 mm
TR-470-15	Ø 1.0 x 70 mm
TR-470-20	Ø 1.2 x 70 mm
TR-470-25	Ø 1.2 x 100 mm
TR-470-30	Ø 1.4 x 70 mm
TR-470-35	Ø 1.4 x 100 mm
TR-470-40	Ø 1.6 x 70 mm
TR-470-50	Ø 1.8 x 100 mm



**Menghini Liver Puncture Needle**  
For Controlled Blind Lever Puncture

Catalog #	Needle Size
TR-472-14	Ø 1.4 x 168 mm
TR-472-18	Ø 1.8 x 168 mm



**Lichtwitz Antrum Puncture Needle**

Catalog #	Needle Size
TR-480-15	Ø 1.5 x 90 mm
TR-480-18	Ø 1.8 x 90 mm
TR-480-20	Ø 2.0 x 90 mm



**Tonsil Needle**  
Tapered Tip, With Luer Lock Connection

Catalog #	Needle Diameter
TR-490-10	Ø 0.65 mm





Special Needles, Vessel Irrigation Cannulas  
 Spezialkanülen, Gefäß-Spülkanülen  
 Aguja especiales, Cánulas para irrigación vascular  
 Aiguilles spéciales, Canules pour irrigation vasculaire  
 Aghi speciali, Cannule per irrigazione vascolare

**Tonsil Needle**  
 Tapered Tip, With Luer Lock Connection



Catalog #	Needle Diameter
TR-491-15	Ø 0.65 mm

**Tonsil Needle**  
 Tapered Tip, With Luer Lock Connection



Catalog #	Needle Diameter
TR-493-20	Ø 0.65 mm

**Verres Insufflation Cannula**  
 With Luer Lock Connection



Catalog #	Size, Cannula Size
TR-500-20	N/A, Ø 2.0 x 100 mm

**Verres Insufflation Cannula**  
 With Luer Lock Connection



Catalog #	Size, Cannula Size
TR-502-20	N/A, Ø 2.0 x 120 mm

**Vollmar Vessel Irrigation Cannula**  
 With Luer Lock Connection



Catalog #	Size, Diameter
TR-520-15	6 cm (2 1/4"), Ø 1.5 mm
TR-520-20	6 cm (2 1/4"), Ø 2.0 mm
TR-520-25	6 cm (2 1/4"), Ø 2.5 mm
TR-520-30	6 cm (2 1/4"), Ø 3.0 mm
TR-520-40	6 cm (2 1/4"), Ø 4.0 mm





Vessel Irrigation Cannulas, Hypodermic Syringes  
Gefäß-Spülkanülen, Spritzen  
Cánulas para irrigación vascular, Jeringas  
Canules pour irrigation vasculaire, Seringues  
Cannule per irrigazione vascolare, Siringhe

**Schmid Vessel Irrigation Cannula**  
Malleable, With Luer Lock Connection



Catalog #	Size, Diameter
TR-530-03	15 cm (6"), Ø 3.0 mm
TR-530-04	15 cm (6"), Ø 4.0 mm
TR-530-05	15 cm (6"), Ø 5.0 mm
TR-530-06	15 cm (6"), Ø 6.0 mm

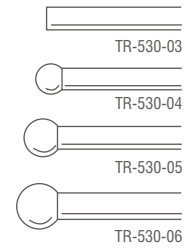

**Mock Heparin Flushing Needle**  
Button End With Luer Lock Connection



Catalog #	Size, Tip Size
TR-550-06	6.5 (2 1/2"), Ø 2.9 x 0.8 mm

**3 Ring Hypodermic Syringe**  
Glass Barrel, With Luer Lock Connection, Moveable Rings



Catalog #	Capacity
TR-600-02	2 ml
TR-600-05	5 ml
TR-600-10	10 ml

**Janet Wound and Bladder Syringe**  
Glass Barrel, With 2 Exchangeable Tips



Catalog #	Capacity
TR-610-05	50 ml
TR-610-10	100 ml
TR-610-15	150 ml
TR-610-20	200 ml



Guide Needles  
Führungsnadeln  
Agujas de guía  
Aiguilles d'introduction  
Aghi conduttori

**Redon Guide Needle**  
Knife Tip



Catalog #	Size, Tip Size
TR-701-08	19.5 cm (7 3/4"), 2.7 mm - 8 Charr.
TR-701-10	19.5 cm (7 3/4"), 3.3 mm - 10 Charr.
TR-701-12	19.5 cm (7 3/4"), 4.0 mm - 12 Charr.
TR-701-14	19.5 cm (7 3/4"), 4.7 mm - 14 Charr.
TR-701-16	19.5 cm (7 3/4"), 5.3 mm - 16 Charr.
TR-701-18	19.5 cm (7 3/4"), 6 mm - 18 Charr.

**Redon Guide Needle**  
Knife Tip



Catalog #	Size, Tip Size
TR-703-08	19.5 cm (7 3/4"), 2.7 mm - 8 Charr.
TR-703-10	19.5 cm (7 3/4"), 3.3 mm - 10 Charr.
TR-703-12	19.5 cm (7 3/4"), 4.0 mm - 12 Charr.
TR-703-14	19.5 cm (7 3/4"), 4.7 mm - 14 Charr.
TR-703-16	19.5 cm (7 3/4"), 5.3 mm - 16 Charr.
TR-703-18	19.5 cm (7 3/4"), 6 mm - 18 Charr.

**Redon Guide Needle**  
Lancet Tip



Catalog #	Size, Tip Size
TR-705-08	19.5 cm (7 3/4"), 2.7 mm - 8 Charr.
TR-705-10	19.5 cm (7 3/4"), 3.3 mm - 10 Charr.
TR-705-12	19.5 cm (7 3/4"), 4.0 mm - 12 Charr.
TR-705-14	19.5 cm (7 3/4"), 4.7 mm - 14 Charr.
TR-705-16	19.5 cm (7 3/4"), 5.3 mm - 16 Charr.
TR-705-18	19.5 cm (7 3/4"), 6 mm - 18 Charr.



Guide Needles  
Führungsnadeln  
Agujas de guía  
Aiguilles d'introduction  
Aghi conduttori

**Redon Guide Needle**  
Lancet Tip



Catalog #	Size, Tip Size
TR-707-08	19.5 cm (7 ¾"), 2.7 mm - 8 Charr.
TR-707-10	19.5 cm (7 ¾"), 3.3 mm - 10 Charr.
TR-707-12	19.5 cm (7 ¾"), 4.0 mm - 12 Charr.
TR-707-14	19.5 cm (7 ¾"), 4.7 mm - 14 Charr.
TR-707-16	19.5 cm (7 ¾"), 5.3 mm - 16 Charr.
TR-707-18	19.5 cm (7 ¾"), 6 mm - 18 Charr.





**SURTEX**  
INSTRUMENTS

*Crafted to Excellence*

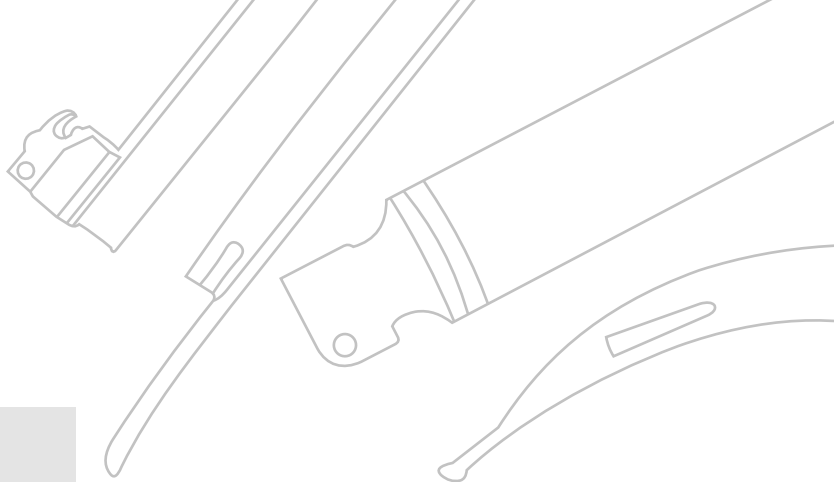

AN

## ANESTHESIA

Surtext Laryngoscopes are designed and manufactured to make intubation simple, convenient and as safe as possible. The outcome is a broad product range featuring innovative design, performance, quality and overall value.

Our range features all popular Macintosh & Miller patterns. Our **Corona**™ premium laryngoscopes and **MAXBright**™ LED sets the industry standard for effortless atraumatic intubation and features distal fibre optic (F.O) for bright illumination and maximum vision of the epiglottis and vocal cords. Our **pollo**™ standard features direct bulb illumination utilizing Surtex xenon illuminated bulbs.

Narkose

Anesthesia

Anesthésie

Anesthesia



Catheter Introducing Forceps, Laryngoscopes and Accessories  
 Kathetereinführzangen, Laryngoskope und Zubehör  
 Pinzas para catéteres, Laringoscopios y accesorios  
 Pinces pour introduire les sondes, Laryngoscopes et accessoires  
 Pinze per introdurre le sonde, Laringoscopi ed accessori

**Magill Catheter Introducing Forcep**  
 For Babies



Catalog #	Size
AN-010-15	14.5 cm (5 ¾"), For Babies
AN-010-20	20 cm (8"), For Children
AN-010-25	25 cm (9 ¾"), For Adults

**Apollo™ Standard Miller-Baby Laryngoscope Set**  
 With Battery Handle Ref: AN-290-01 and 2 Blades Ref: AN-110-00 to AN-110-01



Catalog #	Size
AN-100-00	Standard

**Apollo™ Standard Miller Laryngoscope Set**  
 With Battery Handle Ref: AN-290-01 and 3 Blades Ref: AN-110-01 to AN-110-03



Catalog #	Size
AN-101-00	Standard

**Apollo™ Standard Miller Laryngoscope Set**  
 With Battery Handle Ref: AN-290-01 and 4 Blades Ref: AN-110-01 to AN-110-04



Catalog #	Size
AN-102-00	Standard

**Apollo™ Standard Miller Laryngoscope Set**  
 With Battery Handle Ref: AN-290-01 and 5 Blades Ref: AN-110-00 to AN-110-04



Catalog #	Size
AN-103-00	Standard



**Apollo™ Standard Miller Laryngoscope Blade**



Catalog #	Blade Length, Fig, Usage
AN-110-00	55 mm, Fig. 0, For Babies
AN-110-01	80 mm, Fig. 1, For Children
AN-110-02	130 mm, Fig. 2, Adolescents
AN-110-03	170 mm, Fig. 3, Women
AN-110-04	180 mm, Fig. 4, Men



**Apollo™ Standard McIntosh-Baby Laryngoscope Set**

With Battery Handle Ref: AN-290-01 and 2 Blades Ref: AN-210-00 to AN-210-01



Catalog #	Size
AN-200-00	Standard



**Apollo™ Standard McIntosh Laryngoscope Set**

With Battery Handle Ref:- AN-290-01 and 3 Blades Ref:- AN-210-01 to AN-210-03



Catalog #	Size
AN-201-00	Standard



**Apollo™ Standard McIntosh Laryngoscope Set**

With Battery Handle Ref:- AN-290-01 and 4 Blades Ref:- AN-210-01 to AN-210-04



Catalog #	Size
AN-202-00	Standard



**Apollo™ Standard McIntosh Laryngoscope Set**

With Battery Handle Ref:- AN-290-01 and 5 Blades Ref:- AN-210-00 to AN-210-04



Catalog #	Size
AN-203-00	Standard





Laryngoscopes and Accessories  
Laryngoskope und Zubehör  
Laringoscopios y accesorios  
Laryngoscopes et accessoires  
Laringoscopi ed accessori

**Apollo™ Standard McIntosh Laryngoscope Blade**  
Fig. 0, For Babies



Catalog #	Blade Length, Fig, Usage
AN-210-00	55 mm, Fig. 0, For Babies
AN-210-01	75 mm, Fig. 1, For Children
AN-210-02	90 mm, Fig. 2, For Adolescents
AN-210-03	110 mm, Fig. 3, For Women
AN-210-04	135 mm, Fig. 4, For Men



**Apollo™ Standard Battery Handle**  
Chrome Plated



Catalog #	Size
AN-290-01	Standard



**Apollo™ Standard Spare Bulb Large**  
For Blades Fig. 2 to 4



Catalog #	Size
AN-294-01	Standard



**Apollo™ Standard Spare Bulb Small**  
For Blades Fig. 0 to 1



Catalog #	Size
AN-294-02	Standard







Laryngoscopes and Accessories  
Laryngoskope und Zubehör  
Laringoscopios y accesorios  
Laryngoscopes et accessoires  
Laringoscopi ed accessori

**Corona™ Premium Fibre Optic McIntosh-Baby Laryngoscope Set**  
With Battery Handle Ref:- AN-590-01 and 2 Blades Ref:- AN-410-00 to AN-410-01



Catalog #	Size
AN-400-00	Standard



**Corona™ Premium Fibre Optic McIntosh Laryngoscope Set**  
With Battery Handle Ref:- AN-590-01 and 3 Blades Ref:- AN-410-01 to AN-410-03



Catalog #	Size
AN-401-00	Standard



**Corona™ Premium Fibre Optic McIntosh Laryngoscope Set**  
With Battery Handle Ref:- AN-590-01 and 4 Blades Ref:- AN-410-01 to AN-410-04



Catalog #	Size
AN-402-00	Standard



**Corona™ Premium Fibre Optic McIntosh Laryngoscope Set**  
With Battery Handle Ref:- AN-590-01 and 5 Blades Ref:- AN-410-00 to AN-410-04



Catalog #	Size
AN-403-00	Standard



**Corona™ Premium Fibre Optic McIntosh Laryngoscope Blade**



Catalog #	Blade Length, Fig, Usage
AN-410-00	55 mm, Fig. 0, For Babies
AN-410-01	70 mm, Fig. 1, For Children
AN-410-02	80 mm, Fig. 2, For Adolescents
AN-410-03	105 mm, Fig. 3, For Women
AN-410-04	130 mm, Fig. 4, For Men





Laryngoscopes and Accessories  
Laryngoskope und Zubehör  
Laringoscopios y accesorios  
Laryngoscopes et accessoires  
Laringoscopi ed accessori

**Corona™ Premium Fibre Optic Miller-Baby Laryngoscope Set**

With Battery Handle Ref:- AN-590-01 and 2 Blades Ref:- AN-510-00 to AN-510-01



Catalog #	Size
AN-500-00	Standard



**Corona™ Premium Fibre Optic Miller Laryngoscope Set**

With Battery Handle Ref:- AN-590-01 and 3 Blades Ref:- AN-510-01 to AN-510-03



Catalog #	Size
AN-501-00	Standard



**Corona™ Premium Fibre Optic Miller Laryngoscope Set**

With Battery Handle Ref:- AN-590-01 and 4 Blades Ref:- AN-510-01 to AN-510-04



Catalog #	Size
AN-502-00	Standard



**Corona™ Premium Fibre Optic Miller Laryngoscope Set**

With Battery Handle Ref:- AN-590-01 and 5 Blades Ref:- AN-510-00 to AN-510-04



Catalog #	Size
AN-503-00	Standard



**Corona™ Premium Fibre Optic Miller Laryngoscope Blade**

Fig. 0, For Babies



Catalog #	Blade Length, Fig, Usage
AN-510-00	55 mm, Fig. 0, For Babies
AN-510-01	80 mm, Fig. 1, For Children
AN-510-02	130 mm, Fig. 2, For Adolescents
AN-510-03	170 mm, Fig. 3, For Women
AN-510-04	180 mm, Fig. 4, For Men





Laryngoscopes and Accessories  
Laryngoskope und Zubehör  
Laringoscopios y accesorios  
Laryngoscopes et accessoires  
Laringoscopi ed accessori

**Corona™ Premium Fibre Optic Battery Handle**  
With 2.5 Volts Xenon Bulb



Catalog #	Size
AN-590-01	Standard

**Corona™ Premium Fibre Optic Battery Handle**  
Slim Profile, With 2.5 Volts Xenon Bulb



Catalog #	Size
AN-592-02	Standard

**Corona™ Premium Fibre Optic Spare Bulb**  
Xenon



Catalog #	Power Rating
AN-594-01	2.5 V



Laryngoscopes and Accessories  
Laryngoskope und Zubehör  
Laringoscopios y accesorios  
Laryngoscopes et accessoires  
Laringoscopi ed accessori

**MaxBright™ LED Fibre Optic McIntosh-Baby Laryngoscope Set**

With Battery Handle Ref:- AN-890-01 and 2 Blades Ref:- AN-710-00 to AN-710-01



Catalog #	Size
AN-700-00	Standard



**MaxBright™ LED Fibre Optic McIntosh Laryngoscope Set**

With Battery Handle Ref:- AN-890-01 and 3 Blades Ref:- AN-710-01 to AN-710-03



Catalog #	Size
AN-701-00	Standard



**MaxBright™ LED Fibre Optic McIntosh Laryngoscope Set**

With Battery Handle Ref:- AN-890-01 and 4 Blades Ref:- AN-710-01 to AN-710-04



Catalog #	Size
AN-702-00	Standard



**MaxBright™ LED Fibre Optic McIntosh Laryngoscope Set**

With Battery Handle Ref:- AN-890-01 and 5 Blades Ref:- AN-710-00 to AN-710-04



Catalog #	Size
AN-703-00	Standard



**MaxBright™ LED Fibre Optic McIntosh Laryngoscope Blade**

Fig. 0, For Babies



Catalog #	Blade Length, Fig, Usage
AN-710-00	55 mm, Fig. 0, For Babies
AN-710-01	70 mm, Fig. 1, For Children
AN-710-02	80 mm, Fig. 2, For Adolescents
AN-710-03	105 mm, Fig. 3, For Women
AN-710-04	130 mm, Fig. 4, For Men





Laryngoscopes and Accessories  
Laryngoskope und Zubehör  
Laringoscopios y accesorios  
Laryngoscopes et accessoires  
Laringoscopi ed accessori

**MaxBright™ Fibre Optic Miller-Baby Laryngoscope Set**

With Battery Handle Ref:- AN-890-01 and 2 Blades Ref:- AN-810-00 to AN-810-01



Catalog #	Size
AN-800-00	Standard



**MaxBright™ Fibre Optic Miller Laryngoscope Set**

With Battery Handle Ref:- AN-890-01 and 3 Blades Ref:- AN-810-01 to AN-810-03



Catalog #	Size
AN-801-00	Standard



**MaxBright™ Fibre Optic Miller Laryngoscope Set**

With Battery Handle Ref:- AN-890-01 and 4 Blades Ref:- AN-810-01 to AN-810-04



Catalog #	Size
AN-802-00	Standard



**MaxBright™ Fibre Optic Miller Laryngoscope Set**

With Battery Handle Ref:- AN-890-01 and 5 Blades Ref:- AN-810-00 to AN-810-04



Catalog #	Size
AN-803-00	Standard



**MaxBright™ Fibre Optic Miller Laryngoscope Blade**

Fig. 0, For Babies



Catalog #	Blade Length, Fig, Usage
AN-810-00	55 mm, Fig. 0, For Babies
AN-810-01	80 mm, Fig. 1, For Children
AN-810-02	130 mm, Fig. 2, For Adolescents
AN-810-03	170 mm, Fig. 3, For Women
AN-810-04	180 mm, Fig. 4, For Men





Laryngoscopes and Accessories  
Laryngoskope und Zubehör  
Laringoscopios y accesorios  
Laryngoscopes et accessoires  
Laringoscopi ed accessori

**MaxBright™ Fibre Optic Battery Handle**  
With 2.5 Volts LED Bulb



Catalog #	Size
AN-890-01	Standard



**MaxBright™ Fibre Optic Battery Handle**  
Slim Profile, With 2.5 Volts LED Bulb



Catalog #	Size
AN-892-02	Standard



**MaxBright™ LED Fibre Optic Spare Bulb**



Catalog #	Power Rating
AN-894-01	2.5 V





**SURTEX**  
INSTRUMENTS

*Crafted to Excellence*

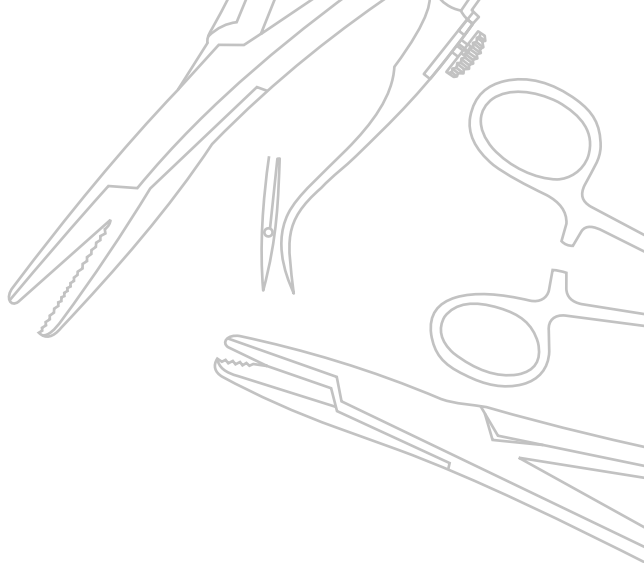

SU



## SUTURE

Surtex offers an entire range of instruments for effortless wound closure ranging from needle holders, micro needle holders, ligature needles and many more. Our complete range of high quality suture instruments at your disposal ensures a perfect suture every time.

Our Suture instruments are produced using latest technology to provide outstanding functionality. The diamond dust  DIN-N-DUST coating or tungsten carbide **ULTRAGrip<sup>X</sup>** which we use on our forceps and needle holders not only provides a safe grip on tissues and suture material, but also ensure high wear resistance in instruments jaws.

Surtex premium needle holders feature the  DIN-N-DUST coating where the working end of the jaws are coated with a ultra-fine layer of diamond dust the result is a high wear resistance surface which provides firm reliable grip for holding suture needles.

**ULTRAGrip<sup>X</sup>** technology these jaw inserts are engineered by grinding individual teeth into hard, wear resistant tungsten carbide to produce a precise, sharp well-defined point with superb gripping properties.

Naht

Sutura

Suture

Sutura





Needle Holders  
Nadelhalter  
Porta-agujas  
Porte-aiguilles  
Portaghi

**Derf Needle Holder**  
One Fenestrated Jaw

Catalog #	Size
SU-010-12	12 cm (4 3/4")



**Converse Needle Holder**  
Jaw With Longitudinal Serrations

Catalog #	Size
SU-012-12	13 cm (5")



**Collier Needle Holder**  
One Grooved Jaws

Catalog #	Size
SU-016-12	12.5 cm (5")



**Webster Needle Holder**  
Smooth Jaws

Catalog #	Size
SU-020-13	13 cm (5")



**Halsey Needle Holder**  
Smooth Jaws

Catalog #	Size
SU-024-13	13.5 cm (5 1/4")







Needle Holders  
Nadelhalter  
Porta-agujas  
Porte-aiguilles  
Portaghi

SU

SUTURE

**Halsey Needle Holder**  
Serrated Jaws



Catalog #	Size
SU-026-13	13.5 cm (5 1/4")

**Kilner Needle Holder**



Catalog #	Size
SU-029-13	13.5 cm (5 1/4")

**Neivert Needle Holder**  
Smooth Jaws With Special Groove



Catalog #	Size
SU-032-13	12.5 cm (5")

**Doyen Needle Holder**



Catalog #	Size
SU-034-13	12.5 cm (5")

**Hegar-Baumgartner Needle Holder**



Catalog #	Size
SU-038-14	14.5 cm (5 3/4")



Needle Holders  
Nadelhalter  
Porta-agujas  
Porte-aiguilles  
Portaghi

**Brown Needle Holder**  
Heavy Pattern



Catalog #	Size
SU-040-13	13 cm (5")
SU-040-18	18 cm (7")

**Lawrence Needle Holder**



Catalog #	Size
SU-042-15	15 cm (6")

**Crile-Murray Needle Holder**  
Slender Pattern



Catalog #	Size
SU-046-15	15 cm (6")

**Crile-Wood Needle Holder**



Catalog #	Size
SU-050-15	15 cm (6")
SU-050-18	18 cm (7")
SU-050-20	20 cm (8")

**Adson Needle Holder**  
One Fenestrated Jaw



Catalog #	Size
SU-052-18	18 cm (7")

INCHES  
MILLIMETERS



Needle Holders  
Nadelhalter  
Porta-agujas  
Porte-aiguilles  
Portaghi

SU

SUTURE

**Metzenbaum Needle Holder**  
One Grooved and Fenestrated Jaws



Catalog #	Size
SU-054-18	18.5 cm (7 1/4")

**M.G. Hospital Needle Holder**  
Heavy Pattern



Catalog #	Size
SU-056-17	17.5 cm (7")

**Mayo-Hegar Needle Holder**



Catalog #	Size
SU-060-14	14.5 cm (5 3/4")
SU-060-16	16 cm (6 1/4")
SU-060-18	18.5 cm (7 1/4")
SU-060-20	20.5 cm (8")
SU-060-24	24 cm (9 1/2")
SU-060-26	26.5 cm (10 1/2")
SU-060-30	30.5 cm (12")

**Mayo-Hegar (Delicate) Needle Holder**  
Slender Pattern



Catalog #	Size
SU-062-16	16 cm (6 1/4")
SU-062-18	18.5 cm (7 1/4")
SU-062-20	20.5 cm (8")



Needle Holders  
Nadelhalter  
Porta-agujas  
Porte-aiguilles  
Portaghi

**Sarot Needle Holder**



Catalog #	Size
SU-068-18	18 cm (7")
SU-068-26	25.5 cm (10")

**Heaney Needle Holder**



Catalog #	Size
SU-070-21	20.5 cm (8")

**Jameson Needle Holder**



Catalog #	Size
SU-072-23	23.5 cm (9 1/4")

**Masson Needle Holder**



Catalog #	Size
SU-074-27	26.5 cm (10 1/2")

**Masson-Luethy Needle Holder**



Catalog #	Size
SU-077-26	25.5 cm (10")

INCHES  
MILLIMETERS



Needle Holders  
Nadelhalter  
Porta-agujas  
Porte-aiguilles  
Portaghi

SU

SUTURE

**Finochietto Needle Holder**



Catalog #	Size
SU-079-27	26.5 cm (10 1/2")

**Wangensteen Needle Holder**



Catalog #	Size
SU-082-27	26.5 cm (10 1/2")

**Johnson Needle Holder**



Catalog #	Size
SU-085-27	27 cm (10 3/4")

**Stratze Needle Holder**

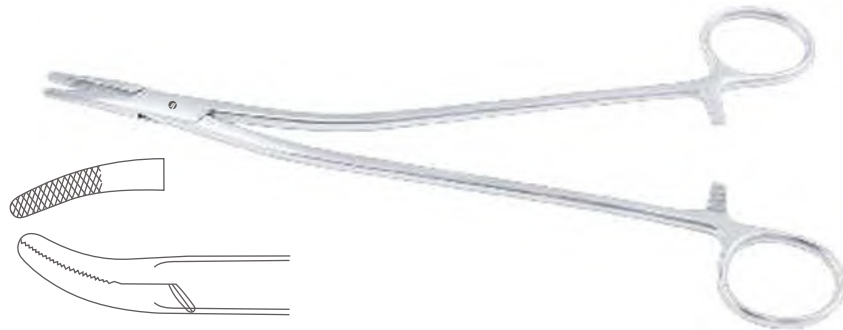

Catalog #	Size
SU-087-20	20 cm (8")
SU-087-23	23 cm (9")

**Olsen-Hegar Needle Holder**

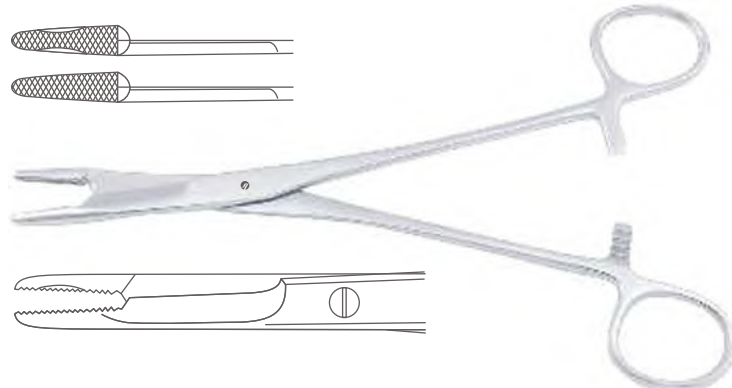

Catalog #	Size
SU-090-14	14 cm (5 1/2")
SU-090-18	18.5 cm (7 1/4")



Needle Holders  
Nadelhalter  
Porta-agujas  
Porte-aiguilles  
Portaghi

**Gillies Needle Holder**

Catalog #	Size
SU-094-16	16 cm (6 1/4")

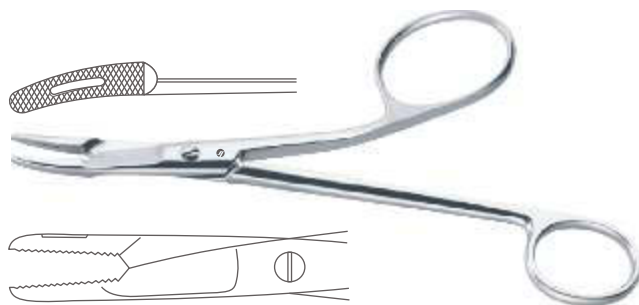

**Mathieu Needle Holder**

Catalog #	Size
SU-100-14	14 cm (5 1/2")
SU-100-17	17 cm (6 3/4")
SU-100-20	20 cm (8")



**Mathieu (Delicate) Needle Holder**

Catalog #	Size
SU-102-14	14 cm (5 1/2")
SU-102-17	16.5 cm (6 1/2")



**Lichtenberg Needle Holder**

Catalog #	Size
SU-110-20	20 cm (8")
SU-110-25	25 cm (9 3/4")



**Zweifel Needle Holder**

Catalog #	Size
SU-120-20	20 cm (8")
SU-120-23	23 cm (9")







Needle Holders  
Nadelhalter  
Porta-agujas  
Porte-aiguilles  
Portaghi

SU

SUTURE

**Hoesel Needle Holder**



Catalog #	Size
SU-124-25	25 cm (9 3/4")

**Crile Needle Holder**



Catalog #	Size
SU-130-15	15 cm (6")

**Toennis Needle Holder**



Catalog #	Size
SU-134-18	18.5 cm (7 1/4")

**Langenbeck Needle Holder**



Catalog #	Size
SU-140-16	16 cm (6 1/4")
SU-140-18	18 cm (7")
SU-140-20	20 cm (8")

**McPherson Micro Needle Holder**  
Straight, Very Delicate, Without Lock



Catalog #	Size
SU-200-10	10 cm (4")



Micro Needle Holders  
Mikro-Nadelhalter  
Micro Porta-agujas  
Micro porte-aiguilles  
Micro Portaghi

**McPherson Micro Needle Holder**  
Curved, Very Delicate, Without Lock

Catalog #	Size
SU-201-10	10 cm (4")



**McPherson Micro Needle Holder**  
Straight, Very Delicate, With Lock

Catalog #	Size
SU-202-10	10 cm (4")



**McPherson Micro Needle Holder**  
Curved, Very Delicate, With Lock

Catalog #	Size
SU-203-10	10 cm (4")



**Castroviejo Micro Needle Holder**  
Straight, Delicate

Catalog #	Size
SU-210-14	14 cm (5 1/2")



**Castroviejo Micro Needle Holder**  
Curved, Delicate

Catalog #	Size
SU-211-14	14 cm (5 1/2")







Micro Needle Holders  
Mikro-Nadelhalter  
Micro Porta-agujas  
Micro porte-aiguilles  
Micro Portaghi

**Castroviejo Micro Needle Holder**  
Straight, Delicate, With Lock



Catalog #	Size
SU-212-14	14 cm (5 1/2")

**Castroviejo Micro Needle Holder**  
Curved, Delicate, With Lock



Catalog #	Size
SU-213-14	14 cm (5 1/2")

**Castroviejo Micro Needle Holder**  
Straight, Standard, Without Lock



Catalog #	Size
SU-220-14	14 cm (5 1/2")

**Castroviejo Micro Needle Holder**  
Curved, Standard, Without Lock



Catalog #	Size
SU-221-14	14 cm (5 1/2")

**Castroviejo Micro Needle Holder**  
Straight, Standard, With Lock



Catalog #	Size
SU-222-14	14 cm (5 1/2")



Micro Needle Holders  
Mikro-Nadelhalter  
Micro Porta-agujas  
Micro porte-aiguilles  
Micro Portaghi

**Castroviejo Micro Needle Holder**  
Curved, Standard, With Lock



Catalog #	Size
SU-223-14	14 cm (5 1/2")

**Jacobson Micro Needle Holder**  
Straight, Without Lock



Catalog #	Size
SU-230-18	18.5 cm (7 1/4")

**Jacobson Micro Needle Holder**  
Straight, With Lock



Catalog #	Size
SU-231-18	18.5 cm (7 1/4")

**Micro Needle Holder**  
Straight, With Lock



Catalog #	Size
SU-234-21	21 cm (8 1/4")

**Yasargil Micro Needle Holder**  
Straight



Catalog #	Size
SU-238-16	16 cm (6 1/4")

INCHES  
MILLIMETERS



Micro Needle Holders  
Mikro-Nadelhalter  
Micro Porta-agujas  
Micro porte-aiguilles  
Micro Portaghi

**Yasargil Micro Needle Holder**  
Curved

Catalog #      Size  
SU-239-16      16 cm (6 1/4")



**Kalt Micro Needle Holder**  
Straight, With Lock

Catalog #      Size  
SU-246-14      13.5 cm (5 1/4")



**Arruga Micro Needle Holder**  
Straight, With Lock

Catalog #      Size  
SU-250-14      13.5 cm (5 1/4")



**Arruga Micro Needle Holder**  
Curved, With Lock

Catalog #      Size  
SU-251-14      13.5 cm (5 1/4")



**Castroviejo Micro Needle Holder**  
Straight, With Lock

Catalog #      Size  
SU-260-13      13 cm (5")





Micro Needle Holders  
Mikro-Nadelhalter  
Micro Porta-agujas  
Micro porte-aiguilles  
Micro Portaghi

**Castroviejo Micro Needle Holder**  
Curved, With Lock



Catalog #	Size
SU-261-13	13 cm (5")

**Arruga Needle Holder**  
Straight, With Ratchet



Catalog #	Size
SU-266-16	16 cm (6 1/4")

**Arruga Needle Holder**  
Curved, With Ratchet



Catalog #	Size
SU-267-16	16 cm (6 1/4")

**Micro Needle Holder**  
Curved, Bayonet Shaped, Smooth Jaws



Catalog #	Size
SU-271-16	16 cm (6 1/4")

**Micro Needle Holder**  
Straight, Bayonet Shaped, Smooth Jaws



Catalog #	Size
SU-274-23	23 cm (9")

INCHES  
MILLIMETERS



Micro Needle Holders  
Mikro-Nadelhalter  
Micro Porta-agujas  
Micro porte-aiguilles  
Micro Portaghi

**Micro Needle Holder**

Curved, Bayonet Shaped, Smooth Jaws



Catalog #	Size
SU-275-23	23 cm (9")

**Micro Needle Holder**

Curved, Bayonet Shaped, Smooth Jaws



Catalog #	Size
SU-277-19	19 cm (7 1/2")

**Yasargil Micro Needle Holder**

Straight, Bayonet Shaped, Smooth Jaws



Catalog #	Size
SU-280-20	20 cm (8")
SU-280-23	23 cm (9")

**Yasargil Micro Needle Holder**

Curved, Bayonet Shaped, Smooth Jaws



Catalog #	Size
SU-281-20	20 cm (8")
SU-281-23	23 cm (9")

**Barraquer-Troutman Micro Needle Holder**

Straight, Extra Delicate, Round Handle



Catalog #	Size
SU-300-10	10 cm (4")



Micro Needle Holders  
Mikro-Nadelhalter  
Micro Porta-agujas  
Micro porte-aiguilles  
Micro Portaghi

**Barraquer-Troutman Micro Needle Holder**  
Curved, Extra Delicate, Round Handle



Catalog #	Size
SU-301-10	10.5 cm (4")

**Barraquer-Troutman Micro Needle Holder**  
Straight, Very Delicate, Round Handle, With Lock



Catalog #	Size
SU-310-10	10.5 cm (4")
SU-310-11	11.5 cm (4½")

**Barraquer-Troutman Micro Needle Holder**  
Curved, Very Delicate, Round Handle, With Lock



Catalog #	Size
SU-311-10	10.5 cm (4")
SU-311-11	11.5 cm (4 ½")

**Barraquer Micro Needle Holder**  
Curved, Delicate, Round Handle



Catalog #	Size
SU-313-11	11.5 cm (4 ½")

**Barraquer Micro Needle Holder**  
Curved, Delicate, Round Handle, With Lock



Catalog #	Size
SU-315-11	11.5 cm (4 ½")





Micro Needle Holders  
Mikro-Nadelhalter  
Micro Porta-agujas  
Micro porte-aiguilles  
Micro Portaghi

**Titan Barraquer Micro Needle Holder**

Curved, Delicate, Round Handle, With Lock, Titanium

Catalog #	Size
SU-315-11 T	11.5 cm (4 1/2")



**Barraquer Micro Needle Holder**

Straight, Very Delicate, Round Handle

Catalog #	Size
SU-320-13	13 cm (5")



**Barraquer Micro Needle Holder**

Curved, Very Delicate, Round Handle

Catalog #	Size
SU-321-13	13 cm (5")



**Barraquer Micro Needle Holder**

Straight, Very Delicate, Round Handle, With Lock

Catalog #	Size
SU-322-13	13 cm (5")



**Barraquer Micro Needle Holder**

Curved, Very Delicate, Round Handle, With Lock

Catalog #	Size
SU-323-13	13 cm (5")





Micro Needle Holders  
Mikro-Nadelhalter  
Micro Porta-agujas  
Micro porte-aiguilles  
Micro Portaghi

**Barraquer Micro Needle Holder**  
Curved, Very Delicate, Round Handle



Catalog #	Size
SU-331-14	14 cm (5 1/2")

**Barraquer Micro Needle Holder**  
Curved, Very Delicate, Round Handle, Titanium

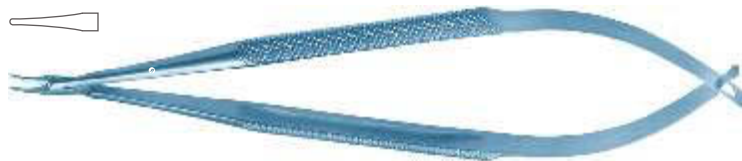

Catalog #	Size
SU-331-14 T	14 cm (5 1/2")

**Barraquer Micro Needle Holder**  
Curved, Very Delicate, Round Handle, With Lock



Catalog #	Size
SU-333-14	14 cm (5 1/2")

**Barraquer Micro Needle Holder**  
Curved, Very Delicate, Round Handle, With Lock, Titanium



Catalog #	Size
SU-333-14 T	14 cm (5 1/2")

**Troutman Micro Needle Holder**  
Strongly Curved, Delicate, Round Handle



Catalog #	Size
SU-341-12	12 cm (4 3/4")

INCHES  
MILLIMETERS





Micro Needle Holders  
Mikro-Nadelhalter  
Micro Porta-agujas  
Micro porte-aiguilles  
Micro Portaghi

**Troutman Micro Needle Holder**

Strongly Curved, Delicate, Round Handle, With Lock



Catalog #	Size
SU-343-12	12 cm (4 3/4")

**Reill Micro Needle Holder**

Straight



Catalog #	Size
SU-350-15	15 cm (6")

**Reill Micro Needle Holder**

Curved



Catalog #	Size
SU-351-15	15 cm (6")

**Micro Needle Holder**

Straight, With Lock



Catalog #	Size
SU-352-15	15 cm (6")

**Micro Needle Holder**

Curved, With Lock



Catalog #	Size
SU-353-15	15 cm (6")



Micro Needle Holders  
Mikro-Nadelhalter  
Micro Porta-agujas  
Micro porte-aiguilles  
Micro Portaghi

**Micro Needle Holder**  
Straight



Catalog #	Size
SU-354-18	18.5 cm (7 1/4")

**Micro Needle Holder**  
Curved



Catalog #	Size
SU-355-18	18.5 cm (7 1/4")

**Micro Needle Holder**  
Straight, With Lock



Catalog #	Size
SU-356-18	18.5 cm (7 1/4")

**Micro Needle Holder**  
Curved, With Lock



Catalog #	Size
SU-357-18	18.5 cm (7 1/4")

**Micro Needle Holder**  
Straight, With Lock



Catalog #	Size
SU-360-20	20 cm (8")

INCHES  
MILLIMETERS



Micro Needle Holders  
Mikro-Nadelhalter  
Micro Porta-agujas  
Micro porte-aiguilles  
Micro Portaghi

**Micro Needle Holder**  
Straight, Delicate, With Lock

Catalog #      Size  
SU-362-23      23 cm (9")



**Diam-n-Dust™ Castroviejo Micro Needle Holder**  
Straight, Extra Delicate



Catalog #      Size  
SU-400-14      14 cm (5 1/2")



**Diam-n-Dust™ Castroviejo Micro Needle Holder**  
Curved, Extra Delicate



Catalog #      Size  
SU-401-14      14 cm (5 1/2")



**Diam-n-Dust™ Castroviejo Micro Needle Holder**  
Straight, Extra Delicate, With Lock



Catalog #      Size  
SU-402-14      14 cm (5 1/2")



**Diam-n-Dust™ Castroviejo Micro Needle Holder**  
Curved, Extra Delicate, With Lock



Catalog #      Size  
SU-403-14      14 cm (5 1/2")





Micro Needle Holders  
Mikro-Nadelhalter  
Micro Porta-agujas  
Micro porte-aiguilles  
Micro Portaghi

**Diam-n-Dust™ Castroviejo Micro Needle Holder**  
Straight, Very Delicate



DIAM-N-DUST

Catalog #	Size
SU-404-14	14 cm (5 1/2")



**Diam-n-Dust™ Castroviejo Micro Needle Holder**  
Curved, Very Delicate



DIAM-N-DUST

Catalog #	Size
SU-405-14	14 cm (5 1/2")



**Diam-n-Dust™ Castroviejo Micro Needle Holder**  
Straight, Very Delicate, With Lock



DIAM-N-DUST

Catalog #	Size
SU-406-14	14 cm (5 1/2")



**Diam-n-Dust™ Castroviejo Micro Needle Holder**  
Curved, Very Delicate, With Lock



DIAM-N-DUST

Catalog #	Size
SU-407-14	14 cm (5 1/2")



**Diam-n-Dust™ Castroviejo Micro Needle Holder**  
Straight, Delicate



DIAM-N-DUST

Catalog #	Size
SU-410-18	18 cm (7")



INCHES  
MILLIMETERS



Micro Needle Holders  
Mikro-Nadelhalter  
Micro Porta-agujas  
Micro porte-aiguilles  
Micro Portaghi

**Diam-n-Dust™ Castroviejo Micro Needle Holder**  
Curved, Delicate



Catalog #	Size
SU-411-18	18 cm (7")



**Diam-n-Dust™ Castroviejo Micro Needle Holder**  
Straight, Delicate, With Lock



Catalog #	Size
SU-412-18	18 cm (7")



**Diam-n-Dust™ Castroviejo Micro Needle Holder**  
Curved, Delicate, With Lock



Catalog #	Size
SU-413-18	18 cm (7")



**Diam-n-Dust™ Micro Needle Holder**  
Straight, Without Lock



Catalog #	Size
SU-420-14	14 cm (5 1/2")
SU-420-18	18 cm (7")
SU-420-21	21 cm (8 1/4")
SU-420-23	23 cm (9")



**Diam-n-Dust™ Micro Needle Holder**  
Straight, With Lock



Catalog #	Size
SU-422-14	14 cm (5 1/2")
SU-422-18	18 cm (7")
SU-422-21	21 cm (8 1/4")
SU-422-23	23 cm (9")





Micro Needle Holders  
Mikro-Nadelhalter  
Micro Porta-agujas  
Micro porte-aiguilles  
Micro Portaghi

**Diam-n-Dust™ Micro Needle Holder**  
Straight, Round Handle



DIAM-N-DUST

Catalog #	Size
SU-430-14	14 cm (5 1/2")



**Diam-n-Dust™ Titan Micro Needle Holder**  
Straight, Round Handle, Titanium



DIAM-N-DUST

Catalog #	Size
SU-430-14 T	14 cm (5 1/2")



**Diam-n-Dust™ Micro Needle Holder**  
Straight, Round Handle



DIAM-N-DUST

Catalog #	Size
SU-430-16	16 cm (6 1/4")



**Diam-n-Dust™ Titan Micro Needle Holder**  
Straight, Round Handle, Titanium



DIAM-N-DUST

Catalog #	Size
SU-430-16 T	16 cm (6 1/4")



**Diam-n-Dust™ Micro Needle Holder**  
Straight, Round Handle



DIAM-N-DUST

Catalog #	Size
SU-430-18	18 cm (7")







Micro Needle Holders  
Mikro-Nadelhalter  
Micro Porta-agujas  
Micro porte-aiguilles  
Micro Portaghi

**Diam-n-Dust™ Titan Micro Needle Holder**  
Straight, Round Handle, Titanium



DIAM-N-DUST

Catalog #	Size
SU-430-18 T	18 cm (7")



**Diam-n-Dust™ Micro Needle Holder**  
Straight, Round Handle



DIAM-N-DUST

Catalog #	Size
SU-430-21	21 cm (8 1/4")



**Diam-n-Dust™ Titan Micro Needle Holder**  
Straight, Round Handle, Titanium



DIAM-N-DUST

Catalog #	Size
SU-430-21 T	21 cm (8 1/4")



**Diam-n-Dust™ Micro Needle Holder**  
Straight, Round Handle



DIAM-N-DUST

Catalog #	Size
SU-430-23	23 cm (9")



**Diam-n-Dust™ Micro Needle Holder**  
Straight, Round Handle, With Lock



DIAM-N-DUST

Catalog #	Size
SU-432-14	14 cm (5 1/2")





Micro Needle Holders  
Mikro-Nadelhalter  
Micro Porta-agujas  
Micro porte-aiguilles  
Micro Portaghi

**Diam-n-Dust™ Titan Micro Needle Holder**  
Straight, Round Handle, With Lock, Titanium



DIAM-N-DUST

Catalog #	Size
SU-432-14 T	14 cm (5 1/2")



**Diam-n-Dust™ Micro Needle Holder**  
Straight, Round Handle, With Lock



DIAM-N-DUST

Catalog #	Size
SU-432-16	16 cm (6 1/4")



**Diam-n-Dust™ Titan Micro Needle Holder**  
Straight, Round Handle, With Lock, Titanium



DIAM-N-DUST

Catalog #	Size
SU-432-16 T	16 cm (6 1/4")



**Diam-n-Dust™ Micro Needle Holder**  
Straight, Round Handle, With Lock



DIAM-N-DUST

Catalog #	Size
SU-432-18	18 cm (7")



**Diam-n-Dust™ Titan Micro Needle Holder**  
Straight, Round Handle, With Lock, Titanium



DIAM-N-DUST

Catalog #	Size
SU-432-18 T	18 cm (7")







Micro Needle Holders  
Mikro-Nadelhalter  
Micro Porta-agujas  
Micro porte-aiguilles  
Micro Portaghi

**Diam-n-Dust™ Micro Needle Holder**  
Straight, Round Handle, With Lock



DIA.M-N-DUST

Catalog #	Size
SU-432-21	21 cm (8 1/4")



**Diam-n-Dust™ Titan Micro Needle Holder**  
Straight, Round Handle, With Lock, Titanium



DIA.M-N-DUST

Catalog #	Size
SU-432-21 T	21 cm (8 1/4")



**Diam-n-Dust™ Micro Needle Holder**  
Straight, Round Handle, With Lock



DIA.M-N-DUST

Catalog #	Size
SU-432-23	23 cm (9")



**Diam-n-Dust™ Micro Needle Holder**  
Straight, Heavy Pattern, Round Handle



DIA.M-N-DUST

Catalog #	Size
SU-440-19	19 cm (7 1/2")
SU-440-23	23 cm (9")
SU-440-25	25 cm (9 3/4")



**Diam-n-Dust™ Micro Needle Holder**  
Straight, Heavy Pattern, Round Handle, With Lock



DIA.M-N-DUST

Catalog #	Size
SU-442-19	19 cm (7 1/2")
SU-442-23	23 cm (9")
SU-442-25	25 cm (9 3/4")





Needle Holders  
Nadelhalter  
Porta-agujas  
Porte-aiguilles  
Portaghi

**Diam-n-Dust™ Castroviejo Micro Needle Holder**  
Straight, With Lock



Catalog #	Size
SU-450-12	12.5 cm (5")

**Diam-n-Dust™ Hepp-Scheidel Micro Needle Holder**  
Straight, With Lock



Catalog #	Size
SU-452-18	18.5 cm (7 1/4")

**Diam-n-Dust™ DeBakey Needle Holder**



Catalog #	Size
SU-460-15	15 cm (6")
SU-460-18	18 cm (7")
SU-460-20	20 cm (8")
SU-460-23	23 cm (9")

**Diam-n-Dust™ Ryder Vascular Needle Holder**



Catalog #	Size
SU-470-13	13 cm (5")
SU-470-15	15 cm (6")
SU-470-18	18 cm (7")
SU-470-22	22 cm (8 3/4")
SU-470-25	25 cm (9 3/4")



Micro Needle Holders  
Mikro-Nadelhalter  
Micro Porta-agujas  
Micro porte-aiguilles  
Micro Portaghi

**UltraGrip™ TC Barraquer Micro Needle Holder**  
Curved, Smooth Jaws, Round Handle



**ULTRAGrip X™**



Catalog #	Size
SU-500-13	13 cm (5")

**UltraGrip™ TC Barraquer Micro Needle Holder**  
Curved, Smooth Jaws, Round Handle , With Lock



**ULTRAGrip X™**



Catalog #	Size
SU-502-13	13 cm (5")

**UltraGrip™ TC Castroviejo Micro Needle Holder**  
Straight, With Lock



**ULTRAGrip X™**



Catalog #	Size
SU-510-14	14.5 cm (5 3/4")

**UltraGrip™ TC Castroviejo Micro Needle Holder**  
Curved, With Lock



**ULTRAGrip X™**



Catalog #	Size
SU-511-14	14.5 cm (5 3/4")

**UltraGrip™ TC Castroviejo Micro Needle Holder**  
Straight, Smooth Jaws, With Lock



**ULTRAGrip X™**



Catalog #	Size
SU-512-14	14.5 cm (5 3/4")



Micro Needle Holders  
Mikro-Nadelhalter  
Micro Porta-agujas  
Micro porte-aiguilles  
Micro Portaghi

**UltraGrip™ TC Castroviejo Micro Needle Holder**  
Curved, Smooth Jaws, With Lock



**ULTRAGrip™ X™**

Catalog #	Size
SU-513-14	14.5 cm (5 3/4")



**UltraGrip™ TC Micro Needle Holder**  
Straight, With Lock



**ULTRAGrip™ X™**

Catalog #	Size
SU-520-18	18 cm (7")



**UltraGrip™ TC Micro Needle Holder**  
Curved, With Lock



**ULTRAGrip™ X™**

Catalog #	Size
SU-521-18	18 cm (7")



**UltraGrip™ TC Jacobson Micro Needle Holder**  
Straight, With Lock



**ULTRAGrip™ X™**

Catalog #	Size
SU-530-21	21.5 cm (8 1/2")



**UltraGrip™ TC Jacobson Micro Needle Holder**  
Curved, With Lock



Catalog #	Size
SU-531-21	21.5 cm (8 1/2")





**UltraGrip™ TC Castroviejo Micro Needle Holder**  
Smooth Jaws, With Lock

**ULTRAGripX™**

Catalog #	Size
SU-540-13	12.5 cm (5")



**UltraGrip™ TC Hepp-Scheidel Micro Needle Holder**  
Smooth Jaws, With Lock

**ULTRAGripX™**

Catalog #	Size
SU-544-18	18.5 cm (7 1/4")



**UltraGrip™ TC Diethrich Micro Needle Holder**

**ULTRAGripX™**

Catalog #	Size
SU-550-16	16 cm (6 1/4")
SU-550-18	18 cm (7")
SU-550-20	20 cm (8")
SU-550-23	23 cm (9")
SU-550-26	26 cm (10 1/2")



**UltraGrip™ TC Arruga Needle Holder**  
Straight

**ULTRAGripX™**

Catalog #	Size
SU-560-16	16 cm (6 1/4")



**UltraGrip™ TC Arruga Needle Holder**  
Curved

Catalog #	Size
SU-561-16	16 cm (6 1/4")

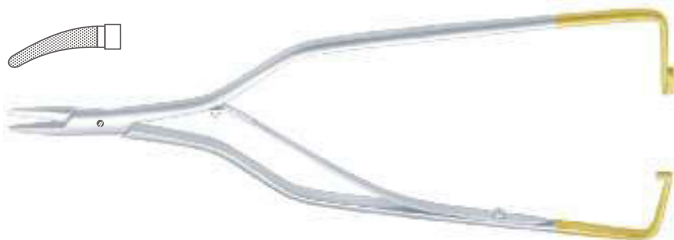



Needle Holders  
Nadelhalter  
Porta-agujas  
Porte-aiguilles  
Portaghi

**UltraGrip™ TC Webster Needle Holder**  
With Automatic Release Ratchet

**ULTRAGrip X™**

Catalog #	Size
SU-564-13	13 cm (5")

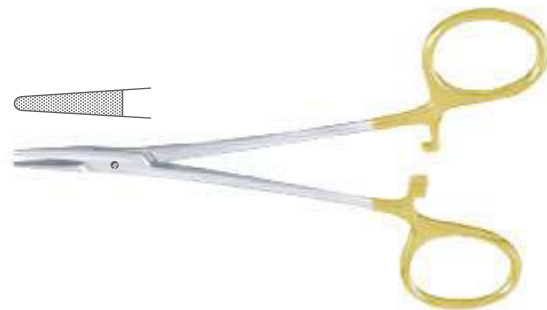

**UltraGrip™ TC Crile-Wood Needle Holder**  
With Automatic Release Ratchet

**ULTRAGrip X™**

Catalog #	Size
SU-566-15	15 cm (6")

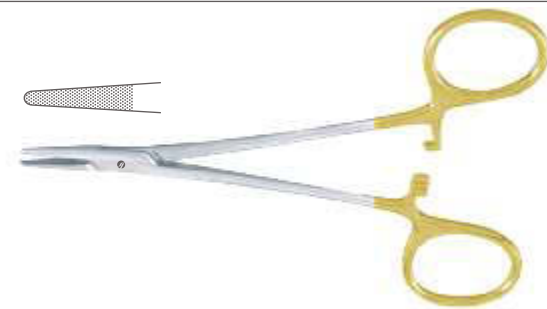

**UltraGrip™ TC Webster Needle Holder**  
Smooth Jaws

**ULTRAGrip X™**

Catalog #	Size
SU-570-13	13 cm (5")

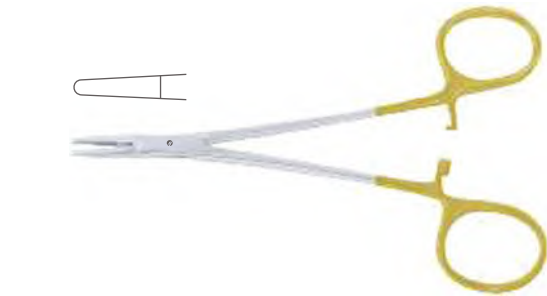

**UltraGrip™ TC Kilner Needle Holder**  
S Shaped

**ULTRAGrip X™**

Catalog #	Size
SU-573-13	13 cm (5")



**UltraGrip™ TC Derf Needle Holder**

**ULTRAGrip X™**

Catalog #	Size
SU-576-12	12 cm (4 3/4")







**UltraGrip™ TC Hegar-Baumgartner Needle Holder**

**ULTRAGripX™**

Catalog #	Size
SU-580-13	13 cm (5")
SU-580-14	14.5 cm (5")



**UltraGrip™ TC Halsey Needle Holder**  
Smooth Jaw

**ULTRAGripX™**

Catalog #	Size
SU-584-13	13 cm (5")



**UltraGrip™ TC Halsey Needle Holder**

**ULTRAGripX™**

Catalog #	Size
SU-586-13	13 cm (5")



**UltraGrip™ TC Webster Needle Holder**  
Smooth Jaw

**ULTRAGripX™**

Catalog #	Size
SU-588-12	12 cm (4 3/4")

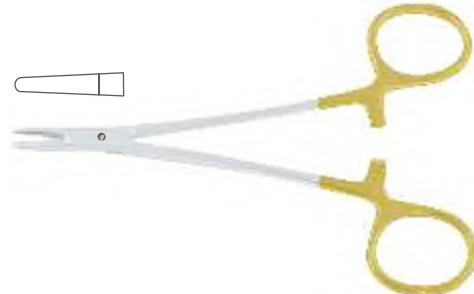

**UltraGrip™ TC Converse Needle Holder**

**ULTRAGripX™**

Catalog #	Size
SU-590-12	12.5 cm (5")

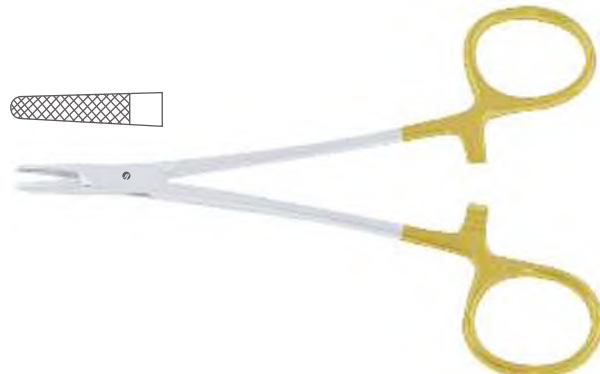



Needle Holders  
Nadelhalter  
Porta-agujas  
Porte-aiguilles  
Portaghi

**UltraGrip™ TC Crile-Wood Needle Holder**

**ULTRAGrip™ X**

Catalog #	Size
SU-594-15	15 cm (6")
SU-594-18	18 cm (7")
SU-594-20	20 cm (8")



**UltraGrip™ TC Sarot Needle Holder**

**ULTRAGrip™ X**

Catalog #	Size
SU-598-18	18 cm (7")
SU-598-20	20 cm (8")
SU-598-26	26 cm (10 1/4")

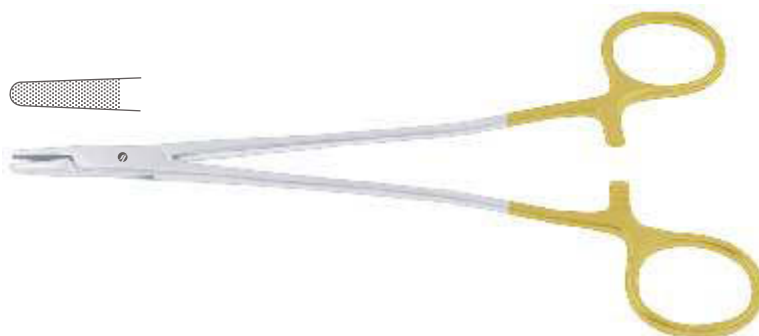

**UltraGrip™ TC Mayo-Hegar Needle Holder**

**ULTRAGrip™ X**

Catalog #	Size
SU-600-14	14.5 cm (5 3/4")
SU-600-16	16 cm (6 1/4")
SU-600-18	18 cm (7")
SU-600-20	20 cm (8")
SU-600-24	24 cm (9 1/2")
SU-600-26	26 cm (10 1/4")
SU-600-30	30 cm (11 3/4")



**UltraGrip™ TC Hegar Needle Holder**

**ULTRAGrip™ X**

Catalog #	Size
SU-602-20	20 cm (8")
SU-602-24	23.5 cm (9 1/4")







**UltraGrip™ TC Heaney Needle Holder**

**ULTRAGripX™**

Catalog #	Size
SU-605-20	20 cm (8")
SU-605-24	24 cm (9 ½")
SU-605-26	26 cm (10 ¼")



**UltraGrip™ TC Bozemann Needle Holder**  
S Shaped

**ULTRAGripX™**

Catalog #	Size
SU-611-20	20.5 cm (8")
SU-611-24	24 cm (9 ½")
SU-611-26	26.5 cm (10 ½")
SU-611-28	29 cm (11 ½")



**UltraGrip™ TC Stratte Needle Holder**

**ULTRAGripX™**

Catalog #	Size
SU-615-21	21 cm (8 ¼")
SU-615-23	23 cm (9")

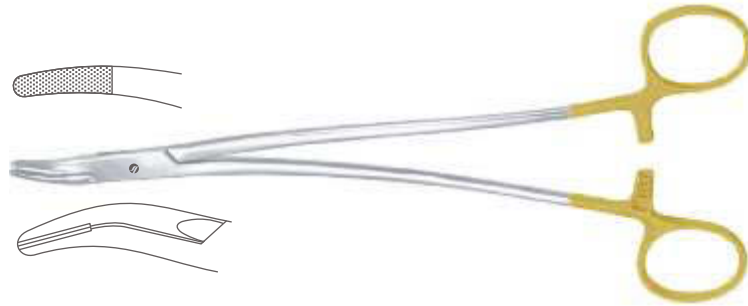

**UltraGrip™ TC Masson Needle Holder**

**ULTRAGripX™**

Catalog #	Size
SU-620-27	26.5 cm (10 ½")





Needle Holders  
Nadelhalter  
Porta-agujas  
Porte-aiguilles  
Portaghi

**UltraGrip™ TC Wangensteen Needle Holder**

**ULTRAGrip X™**

Catalog #	Size
SU-624-27	27 cm (10 3/4")

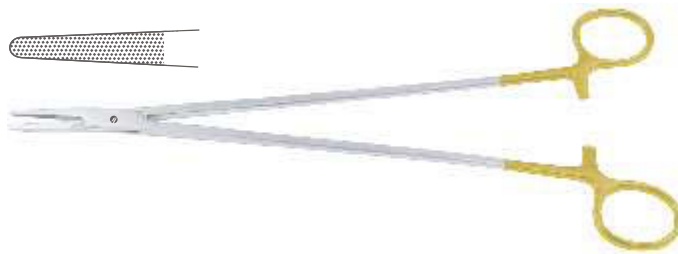

**UltraGrip™ TC Needle Holder**

**ULTRAGrip X™**

Catalog #	Size
SU-625-27	27 cm (10 3/4")



**UltraGrip™ TC Finochietto Needle Holder**

**ULTRAGrip X™**

Catalog #	Size
SU-627-27	26.5 cm (10 1/2")



**UltraGrip™ TC Naunton-Morgan Needle Holder**  
Compound Action

**ULTRAGrip X™**

Catalog #	Size
SU-630-26	26 cm (10 1/4")



**UltraGrip™ TC DeBakey Needle Holder**

**ULTRAGrip X™**

Catalog #	Size
SU-650-18	18 cm (7")
SU-650-20	20 cm (8")
SU-650-23	23 cm (9")
SU-650-26	26 cm (10 1/4")
SU-650-31	31 cm (12 1/4")





**UltraGrip™ TC Ryder Needle Holder**

**ULTRAGripX™**

Catalog #	Size
SU-660-13	12.5 cm (5")
SU-660-15	15 cm (6")
SU-660-18	18 cm (7")
SU-660-20	20 cm (8")
SU-660-23	23 cm (9")
SU-660-26	26 cm (10 1/4")



**UltraGrip™ TC Ryder-Vascular Needle Holder**

**ULTRAGripX™**

Catalog #	Size
SU-664-13	12.5 cm (5")
SU-664-15	15 cm (6")
SU-664-18	18 cm (7")
SU-664-20	20 cm (8")
SU-664-23	22.5 cm (8 3/4")
SU-664-26	26 cm (10 1/4")



**UltraGrip™ TC Martin Needle Holder**

**ULTRAGripX™**

Catalog #	Size
SU-670-15	15 cm (6")
SU-670-17	17 cm (6 3/4")
SU-670-20	20 cm (8")

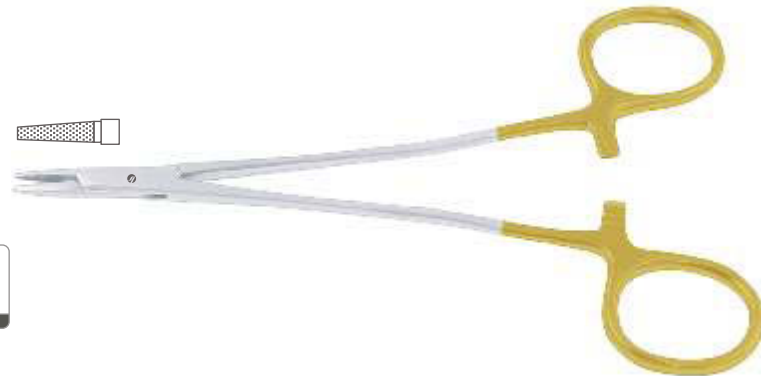



Needle Holders  
Nadelhalter  
Porta-agujas  
Porte-aiguilles  
Portaghi

**UltraGrip™ TC Hegar-Vascular Needle Holder**

**ULTRAGrip X™**

Catalog #	Size
SU-674-14	14 cm (5 1/2")
SU-674-18	18.5 cm (7 1/4")
SU-674-20	20.5 cm (8")
SU-674-23	23 cm (9")



**UltraGrip™ TC Micro Vascular Needle Holder**

**ULTRAGrip X™**

Catalog #	Size
SU-678-14	14 cm (5 1/2")
SU-678-18	18 cm (7")
SU-678-20	20 cm (8")
SU-678-23	23 cm (9")



**UltraGrip™ TC Martini Needle Holder**  
Smooth Jaw

**ULTRAGrip X™**

Catalog #	Size
SU-680-14	14 cm (5 1/2")
SU-680-16	16 cm (6 1/4")
SU-680-18	18 cm (7")
SU-680-20	20 cm (8")



**UltraGrip™ TC Martini Needle Holder**

**ULTRAGrip X™**

Catalog #	Size
SU-682-14	14 cm (5 1/2")
SU-682-16	16 cm (6 1/4")
SU-682-18	18 cm (7")
SU-682-20	20 cm (8")





Needle Holders  
Nadelhalter  
Porta-agujas  
Porte-aiguilles  
Portaghi

SU

SUTURE

**UltraGrip™ TC Olsen-Hegar Needle Holder**

**ULTRAGrip X™**

Catalog #	Size
SU-690-14	14.5 cm (5 ¾")
SU-690-17	17 cm (6 ¾")
SU-690-18	19 cm (7 ½")



**UltraGrip™ TC Foster-Gillies Needle Holder**  
Smooth Jaws

**ULTRAGrip X™**

Catalog #	Size
SU-693-11	11 cm (4 ¼")



**UltraGrip™ TC Gillies-Mini Needle Holder**

**ULTRAGrip X™**

Catalog #	Size
SU-695-15	15 cm (6")



**UltraGrip™ TC Gillies Needle Holder**

**ULTRAGrip X™**

Catalog #	Size
SU-697-16	16 cm (6 ¼")

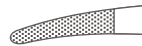

**UltraGrip™ TC Mathieu Needle Holder**

**ULTRAGrip X™**

Catalog #	Size
SU-700-14	14 cm (5 ½")
SU-700-17	17 cm (6 ¾")
SU-700-20	20 cm (8")





Needle Holders  
Nadelhalter  
Porta-agujas  
Porte-aiguilles  
Portaghi

**UltraGrip™ TC Mathieu Needle Holder**

**ULTRAGrip X™**

Catalog #	Size
SU-702-14	14 cm (5 1/2")
SU-702-17	17 cm (6 3/4")
SU-702-20	20 cm (8")



**UltraGrip™ TC Mathieu Needle Holder  
With Interior Ratchet**

**ULTRAGrip X™**

Catalog #	Size
SU-706-17	17 cm (6 3/4")
SU-706-20	20 cm (8")
SU-706-23	23 cm (9")



**UltraGrip™ TC Lichtenberg Needle Holder**

**ULTRAGrip X™**

Catalog #	Size
SU-710-20	20 cm (8")



**UltraGrip™ TC Zweifel Needle Holder  
With Hinged Ratchet**

**ULTRAGrip X™**

Catalog #	Size
SU-720-20	20.5 cm (8")
SU-720-23	23 cm (9")





Needle Holder, Ligature Needles  
Nadelhalter, Unterbindungsnadeln  
Porta-agujas, Agujas para ligaduras  
Porte-aiguilles, Aiguilles à ligatures  
Portaghi, Aghi per legatura

**UltraGrip™ TC Toennis Needle Holder**

**ULTRAGrip™ X™**

Catalog #	Size
SU-730-18	18.5 cm (7 1/4")



**UltraGrip™ TC Langenbeck Needle Holder**

**ULTRAGrip™ X™**

Catalog #	Size
SU-740-18	18 cm (7")
SU-740-20	20.5 cm (8")
SU-740-23	23 cm (9")



**Reverdin Ligature Needle Short**

Catalog #	Size
SU-801-15	14.5 cm (5 3/4")

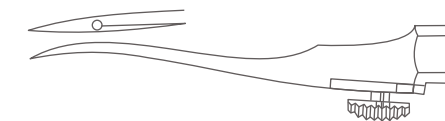

**Reverdin Ligature Needle Short**

Catalog #	Size
SU-803-15	14.5 cm (5 3/4")

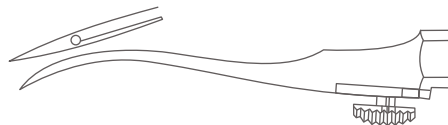

**Reverdin Ligature Needle Short**

Catalog #	Size
SU-805-15	14.5 cm (5 3/4")

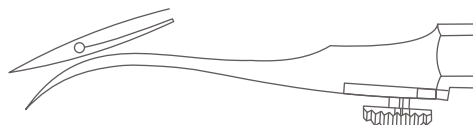





Ligature Needles  
Unterbindungsnadeln  
Agujas para ligaduras  
Aiguilles à ligatures  
Aghi per legatura

**Reverdin Ligature Needle**  
Short

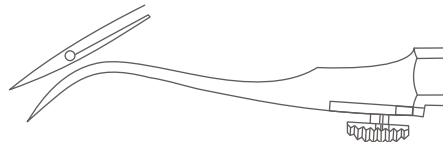

Catalog #	Size
SU-807-15	14.5 cm (5 3/4")

**Reverdin Ligature Needle**  
Medium

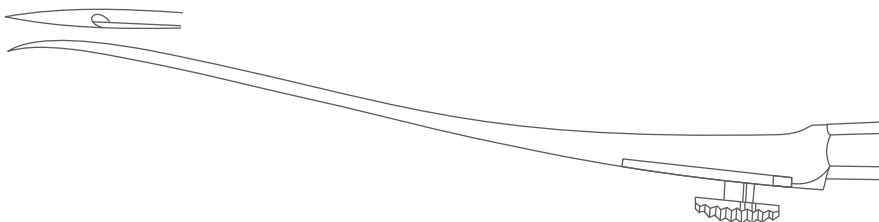

Catalog #	Size
SU-811-19	19.5 cm (7 3/4")

**Reverdin Ligature Needle**  
Medium

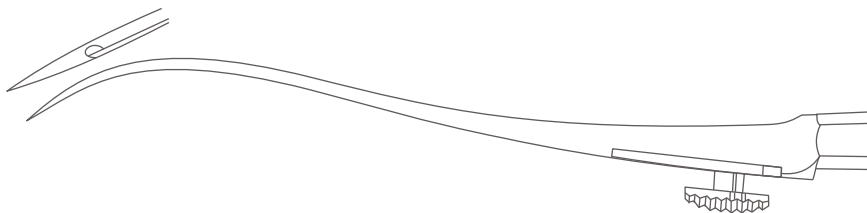

Catalog #	Size
SU-813-19	19.5 cm (7 3/4")

**Reverdin Ligature Needle**  
Medium

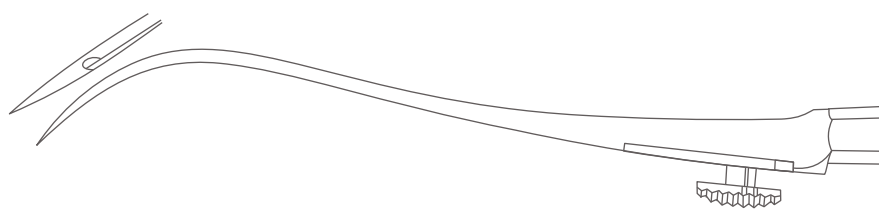

Catalog #	Size
SU-815-19	19.5 cm (7 3/4")

**Reverdin Ligature Needle**  
Medium

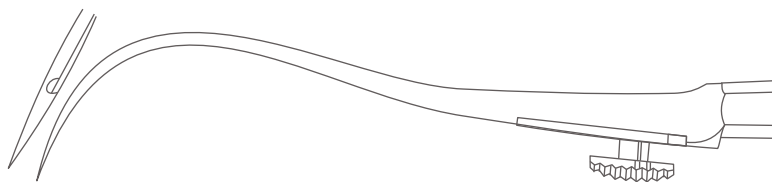

Catalog #	Size
SU-817-19	19.5 cm (7 3/4")

INCHES  
MILLIMETERS





Ligature Needles  
Unterbindungsnadeln  
Agujas para ligaduras  
Aiguilles à ligatures  
Aghi per legatura

**Reverdin Ligature Needle**  
Long

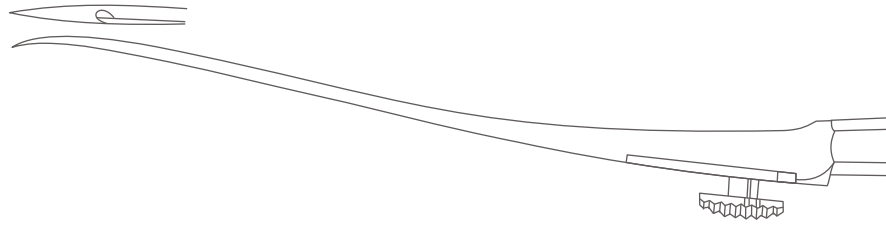

Catalog #	Size
SU-821-23	23 cm (9")



**Reverdin Ligature Needle**  
Long

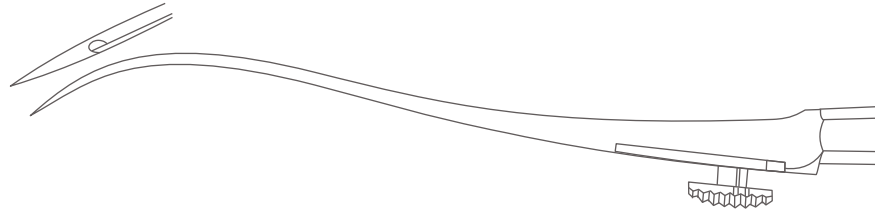

Catalog #	Size
SU-823-23	23 cm (9")



**Reverdin Ligature Needle**  
Long

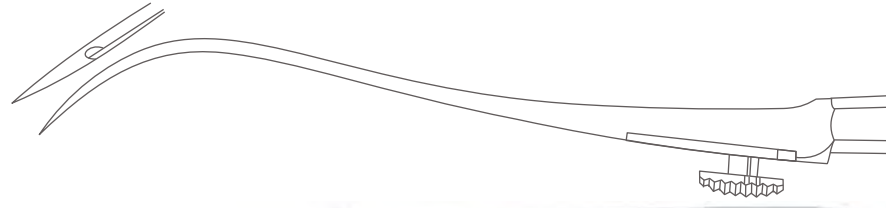

Catalog #	Size
SU-825-23	23 cm (9")



**Reverdin Ligature Needle**  
Long

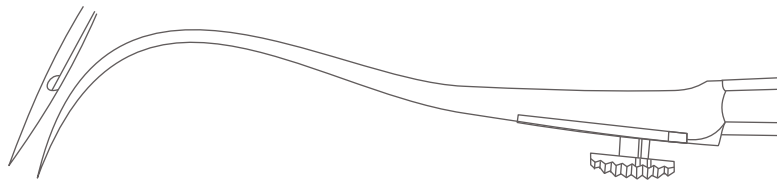

Catalog #	Size
SU-827-23	23 cm (9")



**Young Ligature Needle Holder Complete**  
With Needle Ref: SU-831-01



Catalog #	Size
SU-831-00	24.5 cm (9 3/4")



Ligature Needles  
Unterbindungsnadeln  
Agujas para ligaduras  
Aiguilles à ligatures  
Aghi per legatura

**Young Ligature Needle Only**  
Fig. 1

Catalog #	Size
SU-831-01	N/A

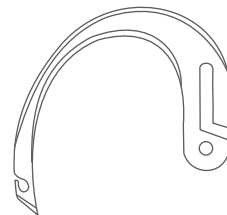

**Young Ligature Needle Only**  
Fig. 2

Catalog #	Size
SU-831-02	N/A

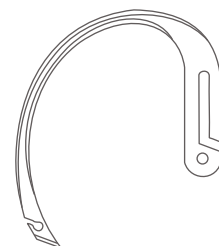

**Young Ligature Needle Only**  
Fig. 3

Catalog #	Size
SU-831-03	N/A

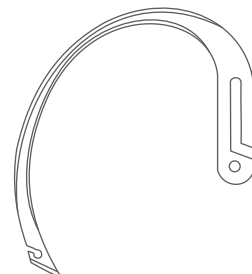

**Schmieden-Dick Ligature Needle**  
Malleable

Catalog #	Size
SU-835-32	29 cm (11 1/2")

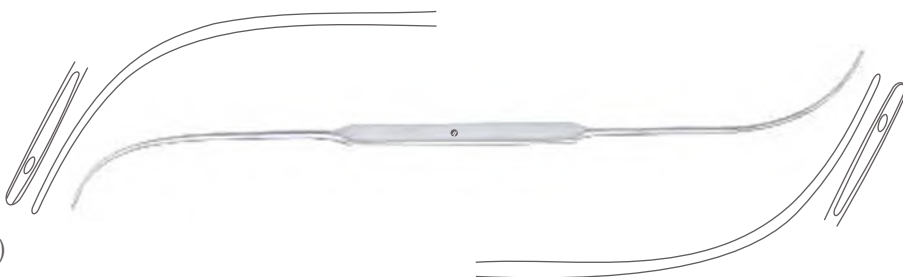

**Schmieden Ligature Needle**

Catalog #	Size
SU-837-21	24 cm (9 1/2")





Ligature Needles  
Unterbindungsnadeln  
Agujas para ligaduras  
Aiguilles à ligatures  
Aghi per legatura

**Ligature Needle**  
Malleable



Catalog #	Size
SU-841-20	20.5 cm (8")

**Jonesco Ligature Needle**



Catalog #	Size
SU-843-18	18.5 cm (7 1/4")

**Claus Van Eicken Ligature Needle**



Catalog #	Size
SU-845-25	25 cm (9 3/4")

**Ligature Needle**

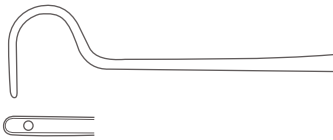

Catalog #	Size
SU-849-15	15 cm (6")

**Syme Ligature Needle**

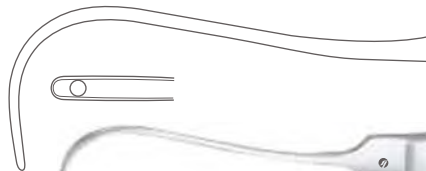

Catalog #	Size
SU-851-17	17 cm (6 3/4")



Ligature Needles  
Unterbindungsnadeln  
Agujas para ligaduras  
Aiguilles à ligatures  
Aghi per legatura

**Cooper Ligature Needle**

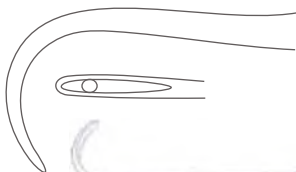

Catalog #	Size
SU-853-19	18.5 cm (7 1/4")



**Kocher Ligature Needle**

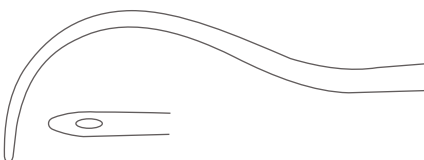

Catalog #	Size
SU-855-20	20.5 cm (8")



**Kronecker Ligature Needle**

Delicate For Right Hand



Catalog #	Size
SU-861-13	12.5 cm (5")



**Kronecker Ligature Needle**

Delicate For Left Hand



Catalog #	Size
SU-863-13	12.5 cm (5")



**Deschamps Ligature Needle**

Blunt For Right Hand

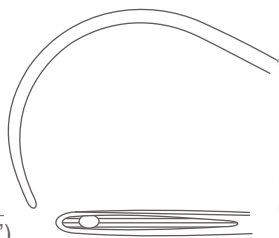

Catalog #	Size
SU-871-24	24 cm (9 1/2")





Ligature Needles  
Unterbindungsnadeln  
Agujas para ligaduras  
Aiguilles à ligatures  
Aghi per legatura

**Deschamps Ligature Needle**  
Blunt For Left Hand



Catalog #      Size  
SU-873-24      24 cm (9 1/2")

**Deschamps Ligature Needle**  
Blunt For Right Hand



Catalog #      Size  
SU-875-20      20 cm (8")

**Deschamps Ligature Needle**  
Blunt For Left Hand



Catalog #      Size  
SU-877-20      20 cm (8")

**Deschamps Ligature Needle**  
Sharp For Right Hand



Catalog #      Size  
SU-879-20      20 cm (8")

**Deschamps Ligature Needle**  
Sharp For Left Hand



Catalog #      Size  
SU-881-20      20 cm (8")



Ligature Needles  
Unterbindungsnadeln  
Agujas para ligaduras  
Aiguilles à ligatures  
Aghi per legatura

**Deschamps Ligature Needle**  
Blunt For Right Hand

Catalog #	Size
SU-883-21	20 cm (8")



**Deschamps Ligature Needle**  
Blunt For Left Hand

Catalog #	Size
SU-885-21	20 cm (8")



**Deschamps Ligature Needle**  
Sharp For Right Hand

Catalog #	Size
SU-887-20	20 cm (8")



**Deschamps Ligature Needle**  
Sharp For Left Hand

Catalog #	Size
SU-889-20	20 cm (8")



**Deschamps Ligature Needle**  
Sharp For Right Hand

Catalog #	Size
SU-891-21	20 cm (8")



INCHES  
MILLIMETERS



Ligature Needles  
Unterbindungsnadeln  
Agujas para ligaduras  
Aiguilles à ligatures  
Aghi per legatura

SU

SUTURE

**Deschamps Ligature Needle**

Sharp For Left Hand



Catalog #      Size  
SU-893-21      20 cm (8")

**Deschamps Ligature Needle**

Blunt For Right Hand



Catalog #      Size  
SU-895-27      27 cm (10 3/4")

**Deschamps Ligature Needle**

Blunt For Left Hand



Catalog #      Size  
SU-897-27      27 cm (10 3/4")

**Deschamps Ligature Needle**

Sharp For Right Hand



Catalog #      Size  
SU-901-27      27 cm (10 3/4")

**Deschamps Ligature Needle**

Sharp For Left Hand



Catalog #      Size  
SU-903-27      27 cm (10 3/4")



Ligature Needles  
Unterbindungsnadeln  
Agujas para ligaduras  
Aiguilles à ligatures  
Aghi per legatura

**Deschamps Ligature Needle**  
Blunt For Right Hand

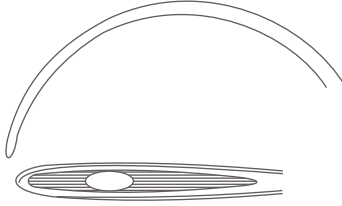

Catalog #	Size
SU-905-28	28 cm (11")

**Deschamps Ligature Needle**  
Blunt For Left Hand

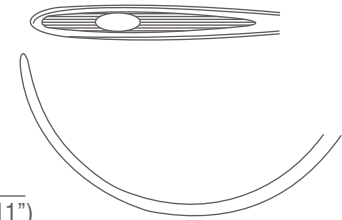

Catalog #	Size
SU-907-28	28 cm (11")

**Deschamps Ligature Needle**  
Sharp For Right Hand



Catalog #	Size
SU-911-20	20 cm (8")

**Deschamps Ligature Needle**  
Sharp For Left Hand



Catalog #	Size
SU-913-20	20 cm (8")

**Deschamps Ligature Needle**  
Blunt For Right Hand

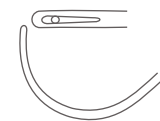

Catalog #	Size
SU-915-20	20 cm (8")

INCHES  
MILLIMETERS





Ligature Needles  
Unterbindungsnadeln  
Agujas para ligaduras  
Aiguilles à ligatures  
Aghi per legatura

**Deschamps Ligature Needle**  
Blunt For Left Hand

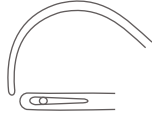

Catalog #      Size  
SU-917-20      20 cm (8")

**Deschamps Ligature Needle**  
Blunt For Right Hand



Catalog #      Size  
SU-921-20      21 cm (8 1/4")

**Deschamps Ligature Needle**  
Blunt For Left Hand



Catalog #      Size  
SU-923-20      21 cm (8 1/4")

**Hurd Ligature Needle**  
Sharp For Right Hand

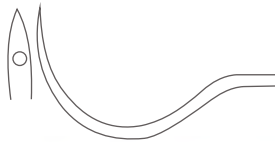

Catalog #      Size  
SU-927-21      20.5 cm (8")

**Hurd Ligature Needle**  
Sharp For Left Hand

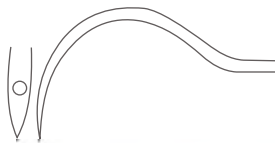

Catalog #      Size  
SU-929-21      20.5 cm (8")



Ligature Needles  
Unterbindungsnadeln  
Agujas para ligaduras  
Aiguilles à ligatures  
Aghi per legatura

**Brunner Ligature Needle**

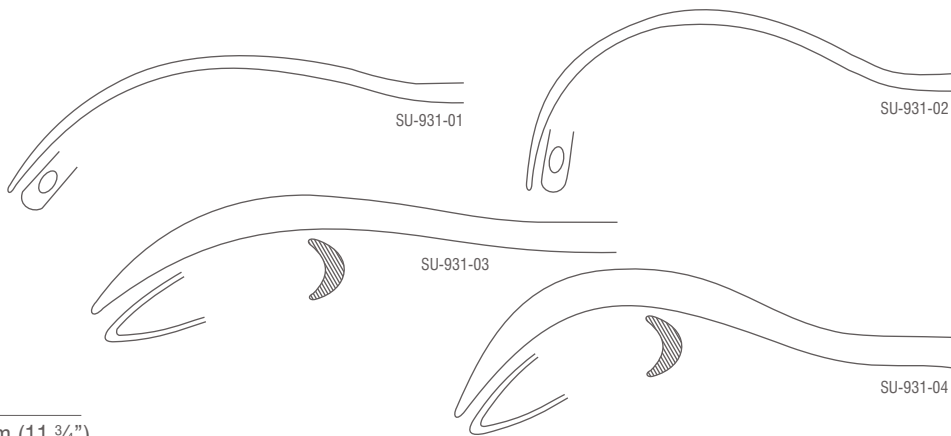

Catalog #	Size
SU-931-01	30 cm (11 3/4")
SU-931-02	30 cm (11 3/4")
SU-931-03	30 cm (11 3/4")
SU-931-04	30 cm (11 3/4")



**Kirschner Ligature Needle**

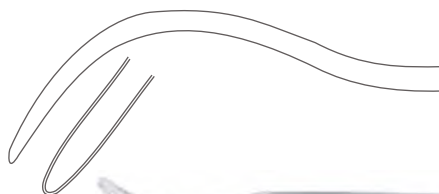

Catalog #	Size
SU-935-25	25.5 cm (10")



**Ligature Needle**

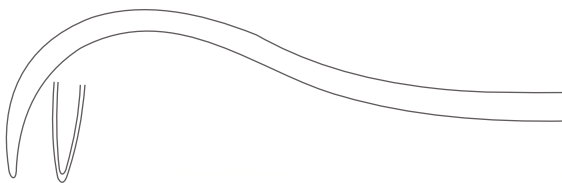

Catalog #	Size
SU-937-28	28 cm (11")



**Martin Ligature Needle**

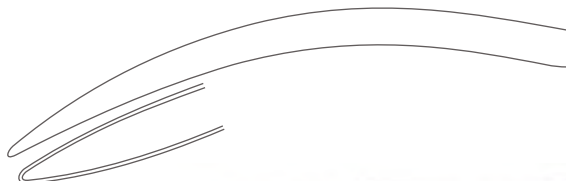

Catalog #	Size
SU-939-25	19.5 cm (7 3/4")



INCHES  
MILLIMETERS



Ligature Conductors  
Führungshohlsonden  
Sondas conductoras  
Sondes conductrices  
Sonde conduttrici

**Brunner Ligature Conductor**  
Ferrozell



Catalog #	Size
SU-941-18	18 cm (7")

**Kirschner Ligature Conductor**  
Ferrozell



Catalog #	Size
SU-943-27	27 cm (10 3/4")

**Ligature Conductor**  
Ferrozell



Catalog #	Size
SU-945-19	19 cm (7 1/2")

**Ligature Conductor**  
Ferrozell



Catalog #	Size
SU-949-24	24 cm (9 1/2")

**Schmieden Ligature Conductor**

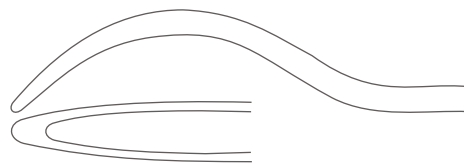

Catalog #	Size
SU-951-19	18 cm (7")



Ligature Conductors  
Führungshohlsonden  
Sondas conductoras  
Sondes conductrices  
Sonde conduttrici

**Schmieden-Payr Ligature Conductor**

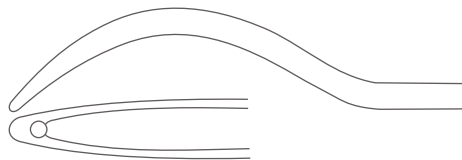

Catalog #	Size
SU-953-19	18 cm (7")

**Koeing Ligature Conductor**

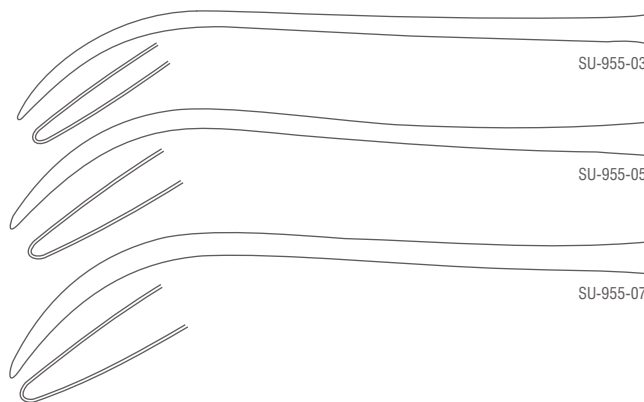

Catalog #	Size
SU-955-03	19.5 cm (7 3/4")
SU-955-05	19.5 cm (7 3/4")
SU-955-07	19.5 cm (7 3/4")

**Payr Ligature Conductor**



Catalog #	Size
SU-957-22	22 cm (8 3/4")

**Payr Ligature Conductor**



Catalog #	Size
SU-959-22	22 cm (8 3/4")



Ligature Conductors  
Führungshohlsonden  
Sondas conductoras  
Sondes conductrices  
Sonde conduttrici

**Modell Wien Ligature Catcher**



Catalog #	Size
SU-961-23	23.5 cm (9 1/4")

**Bozemann Knot Tier**



Catalog #	Size
SU-963-21	21 cm (8 1/4")

**Ligature Adjuster**



Catalog #	Size
SU-965-23	23 cm (9")

**Caspar Ligature Adjuster**  
Bayonet Shaped



Catalog #	Size
SU-967-23	23 cm (9")

**Millin Ligature Holding Forcep**



Catalog #	Size
SU-969-24	24 cm (9 1/2")



Clip Applying Forceps  
Wundklammerpinzetten, Wundklammerzängchen  
Pinzas aplicadoras para agrafes  
Pinces à poser les agrafes  
Pinze per applicare le agrafe

**Childe Approximation Forcep**  
Heavy Pattern With Clip Holder



Catalog #	Size
SU-980-18	17.5 cm (7")

**Michel Clip Applying Forcep**



Catalog #	Size
SU-984-12	12 cm (4 3/4")

**Hegenbarth Clip Applying Forcep**



Catalog #	Size
SU-986-12	12 cm (4 3/4")

**Wachenfeldt Clip Applying Forcep**



Catalog #	Size
SU-988-12	12 cm (4 3/4")

**Michel Clip Applying & Removing Forcep**  
For Applying and Removal of Clips



Catalog #	Size
SU-990-12	12.5 cm (5")



Clip Applying Forceps  
Wundklammerpinzetten, Wundklammerzängchen  
Pinzas aplicadoras para agrafes  
Pincas à poser les agrafes  
Pinze per applicare le agrafe

**Michel Clip Applying & Removing Forcep**  
Long Jaws For Applying and Removal of Clips



Catalog #	Size
SU-992-12	13 cm (5")

**Collin Clip Applying Forcep**  
With Screw Lock



Catalog #	Size
SU-994-13	13 cm (5")

**Richter Clip Applying Forcep**  
With Screw Lock



Catalog #	Size
SU-997-14	13.5 cm (5 1/4")

**Michel Suture Clips**  
Pack of 1000

Catalog #	Clip Size
SU-999-01	7.5 x 1.75 mm
SU-999-02	11 x 2.0 mm
SU-999-03	12 x 3.0 mm
SU-999-04	14 x 3.0 mm
SU-999-05	16 x 3.0 mm
SU-999-06	18 x 3.0 mm
SU-999-07	20 x 3.0 mm
SU-999-08	22 x 3.0 mm

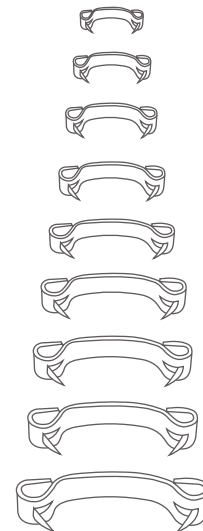







**SURTEX**  
INSTRUMENTS

*Crafted to Excellence*

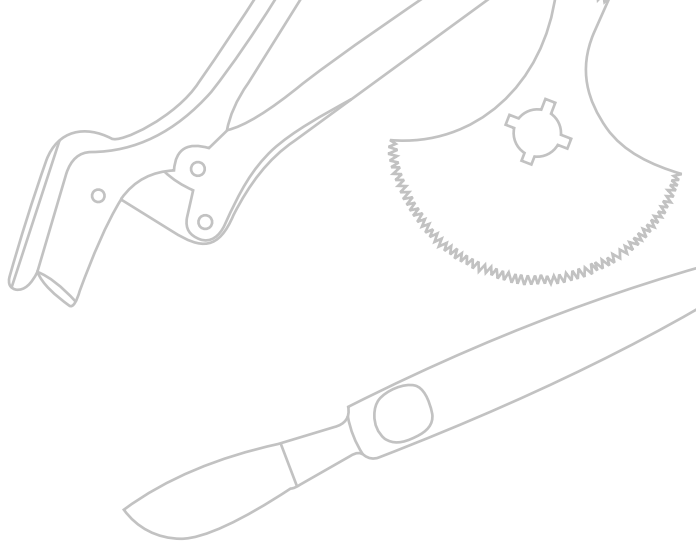

DR



## DRESSING INSTRUMENTS

Surtex has developed an unbeatable reputation worldwide for the most competitively priced and high quality dressing tools on the market place. You will be pleased to note we apply the same high standards to these simple instruments as those applied to the most delicate of instruments in our range.

Verband Instrumente

Vendajes Instrumentos

Pansements Instruments

Bendaggi Strumenti



Plaster Shears, Plaster Knives  
Gipsscheren, Gipsmesser  
Tijeras para yeso, Cuchillos para yeso  
Ciseaux pour plâtre, Couteaux pour plâtre  
Forbici per gesso, Coltelli per gesso

### Stille Plaster of Paris Shear



Catalog #	Size
DR-100-23	23 cm (9")
DR-100-26	27 cm (10 3/4")
DR-100-37	38 cm (15")

### Hopkins Plaster Knife



Catalog #	Size
DR-150-20	20 cm (8")

### Esmarch Plaster Knife



Catalog #	Size
DR-156-18	18 cm (7")

### Reiner Plaster Knife



Catalog #	Size
DR-160-18	18 cm (7")

### Martin Plaster Knife



Catalog #	Size
DR-164-21	21 cm (8 1/4")



Plaster Spreaders  
Gipsspreizer  
Separadores para yeso  
Pinces pour plâtre  
Pinze per gesso

**Engel Plaster Saw**



Catalog #	Size
DR-171-15	15.5 cm (6")

**Beeson Plaster Spreader**



Catalog #	Size
DR-200-48	30 cm (12")

**Hennig Plaster Spreader**



Catalog #	Size
DR-220-28	28 cm (11")

**Quattro (Mod. USA) Plaster Spreader**



Catalog #	Size
DR-228-23	23 cm (9")

**Wolff Plaster Breaker**

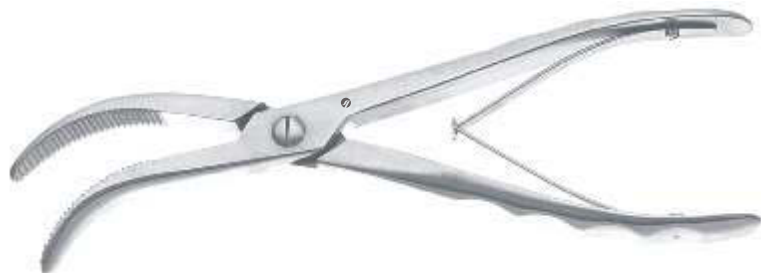

Catalog #	Size
DR-251-18	18 cm (7")
DR-251-26	26.5 cm (10 ½")



Plaster Shears  
Gipsscheren  
Tijeras para yeso  
Ciseaux pour plâtre  
Forbici per gesso

**Surtex OsciPower™ Plaster Saw**



Catalog #	Power Rating
DR-300-00	220 V
DR-300-01	110 V

**Wrench**  
Pair



Catalog #	Size
DR-320-01	Standard

**Round Saw Blade**

Catalog #	Diameter
DR-310-44	Ø 44 mm
DR-310-50	Ø 50 mm
DR-310-65	Ø 65 mm
DR-310-80	Ø 80 mm

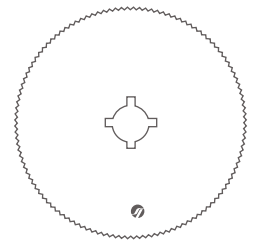

**Segment Saw Blade**

Catalog #	Diameter
DR-314-65	Ø 65 mm

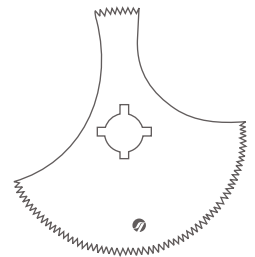

**Waisted Saw Blade**

Catalog #	Diameter
DR-318-65	Ø 65 mm

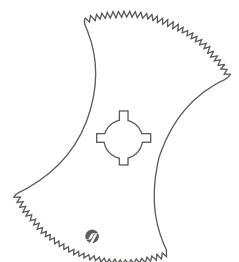



Plaster Shears  
Gipsscheren  
Tijeras para yeso  
Ciseaux pour plâtre  
Forbici per gesso

**Deep Saw Blade**

Catalog #	Diameter
DR-320-70	Ø 70 mm

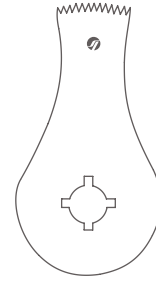

**Deep Saw Blade for Aspiration**

Catalog #	Diameter
DR-322-80	Ø 80 mm

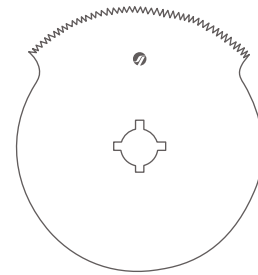

**Vacuum Cleaner**

Catalog #	Size
DR-400-00	Standard







**SURTEX**  
INSTRUMENTS

*Crafted to Excellence*

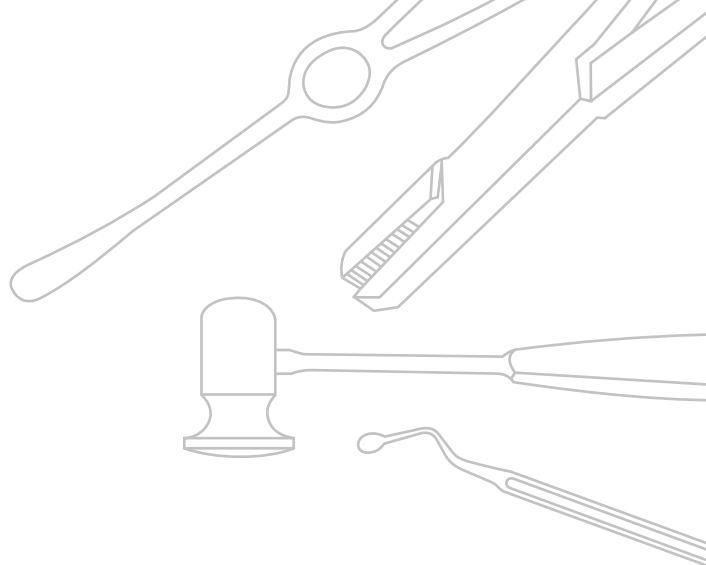

OR

## BONE SURGERY

Surtex offers one of the most comprehensive range of orthopedic instruments in the global market place. The aim of these products is to facilitate easier and swift operations that minimize patient's post-operative discomfort. Whether you are looking for specific instruments such as amputation saws, hand drills, mallets and bone cutting forceps or complete orthopedic sets you will find that Surtex instruments is the best orthopedic instrument solutions provider.

The choice of material with just the right Rockwell hardness value (HRC) in combination with the manufacturing method provides the osteotomes, chisels etc with their unique cutting properties. Special sharpening techniques allow the instruments to remain sharp for extended periods before they need to be re-sharpened. The handles are ergonomically designed for a firm and comfortable grip.

Our range of orthopedic instruments includes and is not limited to the following amputation saws, battery operated drills, bone reamers, bone drills, twist drills, burrs, trephines, wire guides, extension bows, K-Wires, bone holding clamps, wire holding forceps, wire cutting forceps, autopsy instruments, bone chisels, bone osteotomes, bone gouges, bone rasps, bone tempers, bone mallets, bone curettes, periosteal elevators, bone levers, knee retractors, meniscus knives, tendon instruments, bone repositioning instruments, bone holding forceps, bone rongeurs, bone cutting forceps, aluminum hands and nail instruments.

Knochenchirurgie

Cirurgia ósea

Chirurgie osseuse

Chirurgia ossea



Amputation Saws  
Amputationssägen  
Sierras de amputación  
Scies à amputation  
Seghe per amputazione

**Charriere Amputation Saw Complete**  
With Saw Blade Ref: OR-010-92



Catalog #	Size
OR-010-35	35 cm (13 3/4")

**Charriere Saw Blade**



Catalog #	Blade Width
OR-010-91	12 mm
OR-010-92	15 mm
OR-010-93	18 mm

**Bier Amputation Saw Complete**  
With Saw Blade Ref: OR-012-92



Catalog #	Size
OR-012-40	40.5 cm (16")

**Bier Saw Blade**



Catalog #	Blade Width
OR-012-91	4 mm
OR-012-92	6 mm
OR-012-93	8 mm

**Langenbeck Amputation Saw**



Catalog #	Size
OR-014-24	24.5 cm (9 3/4")





Amputation Saws  
Amputationssägen  
Sierras de amputación  
Scies à amputation  
Seghe per amputazione

**Charriere Amputation Saw Complete**

With Saw Blade Ref: OR-016-90

Catalog #	Size
OR-016-27	26.5 cm (10 1/2")



**Satterlee Amputation Saw Complete**

With Saw Blade Ref: OR-018-90

Catalog #	Size
OR-018-29	29 cm (11 1/2")



**Satterlee Saw Blade**

Catalog #	Size
OR-018-90	Standard



**Battery Operated Drill**

Catalog #	Power Rating
OR-020-01	9.6 V



**Adapter With Jacobs Chuck**

Catalog #	Size
OR-020-02	Standard





Battery Drilling Unit  
Akku bohrapparat  
Unidad de perforación batería  
Unité de forage batterie  
Unità di foratura batteria

**Adapter for K Wire**

Catalog #	Size
OR-020-03	Standard



**Adapter for DIN Chuck**

Catalog #	Size
OR-020-04	Standard



**Adapter for AO Chuck**

Catalog #	Size
OR-020-05	Standard



**Adapter for Harris Chuck**

Catalog #	Size
OR-020-06	Standard



**Adapter for Hudson Chuck**

Catalog #	Size
OR-020-07	Standard





Battery Drilling Unit  
Akku bohrapparat  
Unidad de perforación batería  
Unité de forage batterie  
Unità di foratura batteria

**Oscillating Sagittal Saw**



Catalog #	Size
OR-020-08	Standard

**Sternum Saw**



Catalog #	Size
OR-020-09	Standard

**Rechargeable Battery**



9.6 V



12 V

Catalog #	Power Rating
OR-020-10	9.6 V
OR-020-11	12 V

**Battery Charger**  
For Single Battery



Catalog #	Power Rating
OR-020-12	220 V

**Battery Charger**  
For Two Batteries



Catalog #	Power Rating
OR-020-13	220 V



Reamer, Hand Drills  
Reibahlen  
Escariadores, Perforadores de mano  
Pointes-carrées, Perforateurs à main  
Punteruoli, Perforatori a mano

**Battery Operated Sagittal Saw**  
Fixed Model



Catalog #	Size
OR-022-01	Standard

**Battery Operated Sternum Saw**  
Fixed Model



Catalog #	Size
OR-022-02	Standard

**Bone Reamer**



Catalog #	Size
OR-024-14	13.5 cm (5 1/4")

**Perthes Bone Reamer**



Catalog #	Size
OR-026-18	18 cm (7")

**Perthes Bone Reamer**



Catalog #	Size
OR-028-21	21.5 cm (8 1/2")



Reamer, Hand Drills  
Reibahlen  
Escariadores, Perforadores de mano  
Pointes-carrées, Perforateurs à main  
Punteruoli, Perforatori a mano

**Bone Reamer**



Catalog #	Size
OR-030-14	14 cm (5 1/2")

**Drill Handle With Chuck**

T-Form, With Key Ref: OR-034-90



Catalog #	Size
OR-034-00	Standard

**Key**



Catalog #	Size
OR-034-90	Standard

**Drill Handle With Chuck**

Longitudinally Bored, With Key Ref: OR-036-90



Catalog #	Size
OR-036-00	Standard

**Key**



Catalog #	Size
OR-036-90	Standard



Hand Drills  
Handbohrapparate  
Perforadores de mano  
Perforateurs à main  
Perforatori a mano

**Stille-Sherman Drill Handle Complete**  
With Twist Drill Ref: OR-044-01 to OR-044-03



Catalog #	Size
OR-040-00	25 cm (9 3/4")

**Stille Drill Handle Complete**  
With Twist Drill Ref: OR-044-01 to OR-044-03



Catalog #	Size
OR-042-00	20.5 cm (8")

**Twist Drill**

Catalog #	Diameter, Profile
OR-044-01	Ø 2.5 mm, Fig. 1
OR-044-02	Ø 3.0 mm, Fig. 2
OR-044-03	Ø 3.5 mm, Fig. 3
OR-044-04	Ø 4.0 mm, Fig. 4



**Trephine**  
Fig. 5

Catalog #	Diameter
OR-044-05	Ø 10.0 mm



**Spherical Burr**

Catalog #	Diameter, Profile
OR-044-06	Ø 5.0 mm, Fig. 6
OR-044-07	Ø 8.0 mm, Fig. 7
OR-044-08	Ø 12.0 mm, Fig. 8
OR-044-09	Ø 16.0 mm, Fig. 9





Hand Drills  
Handbohrapparate  
Perforadores de mano  
Perforateurs à main  
Perforatori a mano

**Twist Drill**

Catalog #	Diameter, Profile
OR-044-10	Ø 1.0 mm, Fig. 10
OR-044-11	Ø 1.5 mm, Fig. 11
OR-044-12	Ø 2.0 mm, Fig. 12



**Hudson Hand Drill Complete**

Complete With 4 Burrs Ref:- OR-050-01 up to OR-050-04

Catalog #	Size
OR-050-00	Standard



**Conical Burr**

Fig. 1

Catalog #	Diameter, Profile
OR-050-01	Ø 9.0 mm, Fig. 1
OR-050-02	Ø 14.0 mm, Fig. 2



**Spherical Burr**

Catalog #	Diameter, Profile
OR-050-03	Ø 16.0 mm, Fig. 3
OR-050-04	Ø 22.0 mm, Fig. 4



**Cushing Flat Trepine**

Catalog #	Diameter, Profile
OR-050-05	Ø 14.0 mm, Fig. 5





Hand Drills  
Handbohrapparate  
Perforadores de mano  
Perforateurs à main  
Perforatori a mano

**McKenzie Burr**



Catalog #	Diameter, Profile
OR-050-07	Ø 13.0 mm, Fig. 7

**Extension Piece**



Catalog #	Size
OR-050-09	Standard

**Moore Handle Drill**

Complete With A Set of Twist Drill Ref: OR-053-03



Catalog #	Size
OR-054-00	Standard

**Twist Drill**

Set of 3



Catalog #	Contents
OR-053-03	(2 Pcs ( Ø 3.2 x 70 mm and 1 Pcs Ø 3.2 mm x 90 mm)

**Martin Hand Drill Complete with Jacobs Chak**

Complete With Jacobs With Ref: OR-058-91 and OR-058-92



Catalog #	Size
OR-058-00	Standard





Hand Drills, Twist Drill, Flat Trephines  
Handbohrapparate, Spiralbohrer, Flachbohrer, Kugelfräser  
Perforadores de mano, Broca espiral, Taladros planos  
Perforateurs à main, Mèche hélicoïdale, Trépans plats  
Perforatori a mano, Punte a spirale, Trapani piatti

**Jacobs Chuck**  
With Borchardt Shaft



Catalog #	Maximum Opening
OR-058-91	6.35 mm

**Key**



Catalog #	Size
OR-058-92	Standard

**Borchardt Twist Drill**  
5 mm Borchardt Shaft, Long Working End

Catalog #	Diameter
OR-060-20	Ø 2.0 mm
OR-060-25	Ø 2.5 mm
OR-060-30	Ø 3.0 mm
OR-060-32	Ø 3.2 mm
OR-060-35	Ø 3.5 mm
OR-060-40	Ø 4.0 mm
OR-060-50	Ø 5.0 mm
OR-060-60	Ø 6.0 mm
OR-060-70	Ø 7.0 mm





Twist Drill, Flat Trephines  
Spiralbohrer, Flachbohrer, Kugelfräser  
Broca espiral, Taladros planos  
Mèche hélicoïdale, Trépan plats  
Punte a spirale, Trapani piatti

**Borchardt Twist Drill**  
5 mm Borchardt Shaft

Catalog #	Diameter
OR-062-10	Ø 1.0 mm
OR-062-12	Ø 1.2 mm
OR-062-15	Ø 1.5 mm
OR-062-18	Ø 1.8 mm
OR-062-20	Ø 2.0 mm
OR-062-22	Ø 2.2 mm
OR-062-25	Ø 2.5 mm
OR-062-28	Ø 2.8 mm
OR-062-30	Ø 3.0 mm
OR-062-32	Ø 3.2 mm
OR-062-35	Ø 3.5 mm
OR-062-40	Ø 4.0 mm
OR-062-50	Ø 5.0 mm



**Borchardt Flat Trepine**  
5 mm Borchardt Shaft

Catalog #	Diameter
OR-064-18	Ø 1.8 mm
OR-064-20	Ø 2.0 mm
OR-064-22	Ø 2.2 mm
OR-064-25	Ø 2.5 mm
OR-064-30	Ø 3.0 mm
OR-064-35	Ø 3.5 mm
OR-064-40	Ø 4.0 mm
OR-064-50	Ø 5.0 mm



**Spherical Burr**  
5 mm Borchardt Shaft

Catalog #	Diameter
OR-066-30	Ø 4.0 mm
OR-066-40	Ø 4.5 mm





Twist Drill, Flat Trephines  
Spiralbohrer, Flachbohrer, Kugelfräser  
Broca espiral, Taladros planos  
Mèche hélicoïdale, Trépans plats  
Punte a spirale, Trapani piatti

**Conical Burr, Fine Spacing**  
5 mm Borchardt Shaft



Catalog #	Diameter
OR-068-30	Ø 4.0 mm
OR-068-50	Ø 5.0 mm

**Twist Drill**  
Smooth Shaft



Catalog #	Diameter
OR-070-10	Ø 1.0 mm
OR-070-15	Ø 1.5 mm
OR-070-20	Ø 2.0 mm
OR-070-25	Ø 2.5 mm
OR-070-28	Ø 2.8 mm
OR-070-30	Ø 3.0 mm
OR-070-32	Ø 3.2 mm
OR-070-35	Ø 3.5 mm
OR-070-40	Ø 4.0 mm
OR-070-45	Ø 4.5 mm
OR-070-50	Ø 5.0 mm
OR-070-60	Ø 6.0 mm

**Doyen Spherical Burr**  
Long Borchardt Shaft



Catalog #	Diameter
OR-072-04	Ø 4.0 mm
OR-072-06	Ø 6.0 mm
OR-072-08	Ø 8.0 mm
OR-072-10	Ø 10.0 mm
OR-072-12	Ø 12.0 mm
OR-072-14	Ø 14.0 mm
OR-072-16	Ø 16.0 mm



Twist Drill, Flat Trephines  
Spiralbohrer, Flachbohrer, Kugelfräser  
Broca espiral, Taladros planos  
Mèche hélicoïdale, Trépan plats  
Punte a spirale, Trapani piatti

**Doyen Spherical Burr**  
Long Borchardt Shaft

Catalog #	Diameter
OR-074-04	Ø 4.0 mm
OR-074-06	Ø 6.0 mm
OR-074-08	Ø 8.0 mm
OR-074-10	Ø 10.0 mm
OR-074-12	Ø 12.0 mm
OR-074-14	Ø 14.0 mm
OR-074-16	Ø 16.0 mm



**Doyen Conical Burr**

Catalog #	Diameter
OR-076-12	Ø 12.0 mm



**Conical Burr, Fine Spacing**

Catalog #	Diameter
OR-078-08	Ø 8.0 mm
OR-078-10	Ø 10.0 mm



**Doyen Cylindrical Burr, Coarse Spacing**

Catalog #	Diameter
OR-080-12	Ø 12.0 mm
OR-080-15	Ø 15.0 mm





Twist Drill, Flat Trephines  
Spiralbohrer, Flachbohrer, Kugelfräser  
Broca espiral, Taladros planos  
Mèche hélicoïdale, Trépans plats  
Punte a spirale, Trapani piatti

**Albee Oval, Coarse Spacing**

Catalog #	Diameter
OR-082-08	Ø 8.0 mm
OR-082-10	Ø 10.0 mm
OR-082-12	Ø 12.0 mm



**Albee Pointed Cutter**

Catalog #	Diameter
OR-084-07	Ø 7.0 mm



**Borchardt Oval Burr, Coarse Spacing**

Catalog #	Diameter
OR-086-13	Ø 13.0 mm



**Flat Burr**  
Short Borchardt Shaft

Catalog #	Diameter
OR-088-25	Ø 25.0 mm



**Toti Trephine**  
Short Borchardt Shaft

Catalog #	Diameter
OR-090-08	Ø 8.0 mm





Hand Drills, Wire Guides, Wire Tightener  
 Handbohrapparate, Drahtumführungsadeln, Drahtspanner  
 Perforadores de mano, Agujas pasa-hilo, Tensor cierra-hilo  
 Perforateurs à main, Aiguilles passe-fils, Tendeur serre-fil  
 Perforatori a mano, Aghi passafili, Strumento tendifili

**Bunnell Hand Drill**

Longitudinally Bored With 3 Jaw Chuck and Key, Light Metal Housing  
 Opening up to 4mm Ø



Catalog #	Size
OR-094-00	Standard

**Ralk Hand Drill**

Longitudinally Bored With 3 Jaw Chuck and Key, Light Metal Housing,  
 Opening up to 4mm Ø



Catalog #	Size
OR-096-00	Standard

**Key**



Catalog #	Size
OR-098-00	Standard

**Screw Driver**



Catalog #	Size, Tip Size
OR-100-15	25 cm (10"), 1.5 mm
OR-100-25	25 cm (10"), 2.5 mm
OR-100-35	25 cm (10"), 3.5 mm
OR-100-90	25 cm (10"), Standard
OR-100-91	25 cm (10"), Standard
OR-100-92	25 cm (10"), Standard

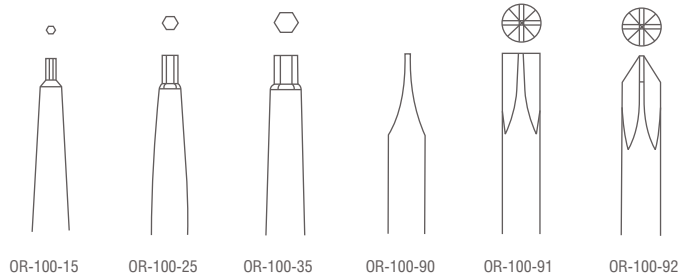

**Demel Wire Guide**

Catalog #	Size, Profile
OR-101-01	31 cm (12 1/4"), Fig. 1
OR-101-02	29 cm (11 1/2"), Fig. 2
OR-101-03	28 cm (11"), Fig. 3





Wire Tightener, Extension Bows  
Drahtspanner, Extensionsbügel  
Tensor cierra-hilo, Estribos para extensión  
Tendeur serre-fil, Etriers à extension  
Strumento tendifili, Archi per estensione

**Loute Wire Tightener**



Catalog #	Size
OR-104-21	21 cm (8 1/4")

**Demel Wire Tightener and Twister**



Catalog #	Size
OR-106-27	27 cm (10 3/4")

**Steinmann Extension Pins**  
With Trocar Point



Catalog #	Size
OR-108-14	14 cm (5 1/2")
OR-108-16	16 cm (6 1/4")
OR-108-18	18 cm (7")
OR-108-20	20 cm (8")

**Bohler Extension Bows**



Catalog #	Inner Width, Profile
OR-110-15	210 x 150 mm For Femur and Knee
OR-110-16	160 x 90 mm For Arm
OR-110-21	210 x 110 mm For Femur and Knee



Extension Bows  
 Extensionsbügel  
 Estribos para extensión  
 Etriers à extension  
 Archi per estensione

**Kirschner Extension Bows**  
 With 3 Traction Hooks

Catalog #	Size, Inner Width, Profile
OR-114-01	90 x 70 mm, For Children
OR-114-02	105 x 105 mm, For Wrist and Ankle
OR-114-03	120 x 120 mm, For Elbow
OR-114-04	155 x 155 mm, For Knee
OR-114-05	200 x 155 mm, For Femur



**Kirschner Extension Bows**  
 With 3 Traction Hooks

Catalog #	Size, Profile
OR-116-01	18.5 cm (7 1/4"), Small Pattern
OR-116-02	26.5 cm (10 1/2"), Large Pattern



**Wire Strainer**

For Ref: OR-581-01 up to OR-581-05

Catalog #	Size
OR-118-18	18.5 cm (7 1/4")



**Wrench**

Catalog #	Size
OR-120-20	20 cm (8")



**Extension Bows**

Catalog #	Inner Width
OR-122-18	180 x 100mm (7" x 4")
OR-122-27	270 x 160mm (10 1/2" x 6 1/4")







**Kirschner Wire Drill**  
Trocar Pointed, Flat End

Catalog #	Size, Diameter
OR-130-06	6 cm (2 1/4"), Ø 0.6 mm
OR-130-08?	6 cm (2 1/4"), Ø 0.8 mm
OR-130-10	6 cm (2 1/4"), Ø 1.0 mm
OR-130-12	6 cm (2 1/4"), Ø 1.2 mm
OR-130-14	6 cm (2 1/4"), Ø 1.4 mm
OR-130-15	6 cm (2 1/4"), Ø 1.5 mm
OR-130-16	6 cm (2 1/4"), Ø 1.6 mm
OR-130-18	6 cm (2 1/4"), Ø 1.8 mm
OR-130-20	6 cm (2 1/4"), Ø 2.0 mm
OR-130-22	6 cm (2 1/4"), Ø 2.2 mm



**Kirschner Wire Drill**  
Trocar Pointed, Round End

Catalog #	Size, Diameter
OR-132-10	6 cm (2 1/4"), Ø 1.0 mm
OR-132-12	6 cm (2 1/4"), Ø 1.2 mm
OR-132-14	6 cm (2 1/4"), Ø 1.4 mm
OR-132-15	6 cm (2 1/4"), Ø 1.5 mm
OR-132-16	6 cm (2 1/4"), Ø 1.6 mm
OR-132-18	6 cm (2 1/4"), Ø 1.8 mm
OR-132-20	6 cm (2 1/4"), Ø 2.0 mm
OR-132-22	6 cm (2 1/4"), Ø 2.2 mm



**Kirschner Wire Drill**  
Trocar Pointed, Round End

Catalog #	Size, Diameter
OR-134-10	10 cm (4"), Ø 1.0 mm
OR-134-12	10 cm (4"), Ø 1.2 mm
OR-134-14	10 cm (4"), Ø 1.4 mm
OR-134-16	10 cm (4"), Ø 1.5 mm





Wire Drills  
Spickdrähte  
Brocas filiformes  
Broches filiformes  
Perforatori filiformi

**Kirschner Wire Drill**  
Trocar Pointed, Flat End

Catalog #	Size, Diameter
OR-136-10	12 cm (4 3/4"), Ø 1.0 mm
OR-136-12	12 cm (4 3/4"), Ø 1.2 mm
OR-136-14	12 cm (4 3/4"), Ø 1.4 mm
OR-136-15	12 cm (4 3/4"), Ø 1.5 mm
OR-136-16	12 cm (4 3/4"), Ø 1.6 mm
OR-136-18	12 cm (4 3/4"), Ø 1.8 mm
OR-136-20	12 cm (4 3/4"), Ø 2.0 mm
OR-136-22	12 cm (4 3/4"), Ø 2.2 mm



**Kirschner Wire Drill**  
Trocar Pointed, Round End

Catalog #	Size, Diameter
OR-138-10	12 cm (4 3/4"), Ø 1.0 mm
OR-138-12	12 cm (4 3/4"), Ø 1.2 mm
OR-138-14	12 cm (4 3/4"), Ø 1.4 mm
OR-138-15	12 cm (4 3/4"), Ø 1.5 mm
OR-138-16	12 cm (4 3/4"), Ø 1.6 mm
OR-138-18	12 cm (4 3/4"), Ø 1.8 mm
OR-138-20	12 cm (4 3/4"), Ø 2.0 mm
OR-138-22	12 cm (4 3/4"), Ø 2.2 mm



**Kirschner Wire Drill**  
Trocar Pointed, Flat End

Catalog #	Size, Diameter
OR-140-10	14 cm (5 1/2"), Ø 1.0 mm
OR-140-12	14 cm (5 1/2"), Ø 1.2 mm
OR-140-14	14 cm (5 1/2"), Ø 1.4 mm
OR-140-15	14 cm (5 1/2"), Ø 1.5 mm
OR-140-16	14 cm (5 1/2"), Ø 1.6 mm
OR-140-18	14 cm (5 1/2"), Ø 1.8 mm
OR-140-20	14 cm (5 1/2"), Ø 2.0 mm
OR-140-22	14 cm (5 1/2"), Ø 2.2 mm





**Kirschner Wire Drill**

Trocar Pointed, Round End

Catalog #	Size, Diameter
OR-142-10	14 cm (5 1/2"), Ø 1.0 mm
OR-142-12	14 cm (5 1/2"), Ø 1.2 mm
OR-142-14	14 cm (5 1/2"), Ø 1.4 mm
OR-142-15	14 cm (5 1/2"), Ø 1.5 mm
OR-142-16	14 cm (5 1/2"), Ø 1.6 mm
OR-142-18	14 cm (5 1/2"), Ø 1.8 mm
OR-142-20	14 cm (5 1/2"), Ø 2.0 mm
OR-142-22	14 cm (5 1/2"), Ø 2.2 mm



**Kirschner Wire Drill**

Trocar Pointed, Flat End

Catalog #	Size, Diameter
OR-144-10	16 cm (6 1/4"), Ø 1.0 mm
OR-144-12	16 cm (6 1/4"), Ø 1.2 mm
OR-144-14	16 cm (6 1/4"), Ø 1.4 mm
OR-144-15	16 cm (6 1/4"), Ø 1.5 mm
OR-144-16	16 cm (6 1/4"), Ø 1.6 mm
OR-144-18	16 cm (6 1/4"), Ø 1.8 mm
OR-144-20	16 cm (6 1/4"), Ø 2.0 mm
OR-144-22	16 cm (6 1/4"), Ø 2.2 mm
OR-144-25	16 cm (6 1/4"), Ø 2.5 mm



**Kirschner Wire Drill**

Trocar Pointed, Round End

Catalog #	Size, Diameter
OR-146-10	16 cm (6 1/4"), Ø 1.0 mm
OR-146-12	16 cm (6 1/4"), Ø 1.2 mm
OR-146-14	16 cm (6 1/4"), Ø 1.4 mm
OR-146-15	16 cm (6 1/4"), Ø 1.5 mm
OR-146-16	16 cm (6 1/4"), Ø 1.6 mm
OR-146-18	16 cm (6 1/4"), Ø 1.8 mm
OR-146-20	16 cm (6 1/4"), Ø 2.0 mm
OR-146-22	16 cm (6 1/4"), Ø 2.2 mm
OR-146-25	16 cm (6 1/4"), Ø 2.5 mm





Wire Drills  
Spickdrähte  
Brocas filiformes  
Broches filiformes  
Perforatori filiformi

**Kirschner Wire Drill**  
Trocar Pointed, Flat End

Catalog #	Size, Diameter
OR-148-10	31 cm (12 1/4"), Ø 1.0 mm
OR-148-12	31 cm (12 1/4"), Ø 1.2 mm
OR-148-14	31 cm (12 1/4"), Ø 1.4 mm
OR-148-15	31 cm (12 1/4"), Ø 1.5 mm
OR-148-16	31 cm (12 1/4"), Ø 1.6 mm
OR-148-18	31 cm (12 1/4"), Ø 1.8 mm
OR-148-20	31 cm (12 1/4"), Ø 2.0 mm
OR-148-22	31 cm (12 1/4"), Ø 2.2 mm
OR-148-25	31 cm (12 1/4"), Ø 2.5 mm



**Kirschner Wire Drill**  
Trocar Pointed, Round End

Catalog #	Size, Diameter
OR-150-10	31 cm (12 1/4"), Ø 1.0 mm
OR-150-12	31 cm (12 1/4"), Ø 1.2 mm
OR-150-14	31 cm (12 1/4"), Ø 1.4 mm
OR-150-15	31 cm (12 1/4"), Ø 1.5 mm
OR-150-16	31 cm (12 1/4"), Ø 1.6 mm
OR-150-18	31 cm (12 1/4"), Ø 1.8 mm
OR-150-20	31 cm (12 1/4"), Ø 2.0 mm
OR-150-22	31 cm (12 1/4"), Ø 2.2 mm
OR-150-25	31 cm (12 1/4"), Ø 2.5 mm



**Kirschner Wire Drill**  
Trocar Pointed, Round End

Catalog #	Size, Diameter
OR-152-10	10 cm (4"), Ø 1.0 mm
OR-152-12	10 cm (4"), Ø 1.2 mm
OR-152-15	10 cm (4"), Ø 1.5 mm
OR-152-16	10 cm (4"), Ø 1.6 mm
OR-152-18	10 cm (4"), Ø 1.8 mm
OR-152-20	10 cm (4"), Ø 2.0 mm
OR-152-22	10 cm (4"), Ø 2.2 mm
OR-152-25	10 cm (4"), Ø 2.5 mm





Wire Twisting Forceps  
Drahtzwirbelzangen  
Pinzas para torcer alambre  
Pinces à torsader le fil  
Pinze per ritorcere fili

**Gerster-Lowman Bone Holding Clamp**

Catalog #	Size
OR-160-18	18 cm (7")
OR-160-20	20 cm (8")
OR-160-22	22 cm (8 3/4")



**Gerster Traction Bar**

Catalog #	Size
OR-162-15	Standard



**UltraGrip™ TC Wire Twisting Forcep**



Catalog #	Size
OR-170-15	15.5 cm (6")
OR-170-18	18 cm (7")



**UltraGrip™ TC Wire Twisting Forcep**



Catalog #	Size
OR-172-15	15.5 cm (6")
OR-172-18	18 cm (7")



**UltraGrip™ TC Wire Twisting Forcep**



Catalog #	Size
OR-174-15	15.5 cm (6")
OR-174-20	20 cm (8")

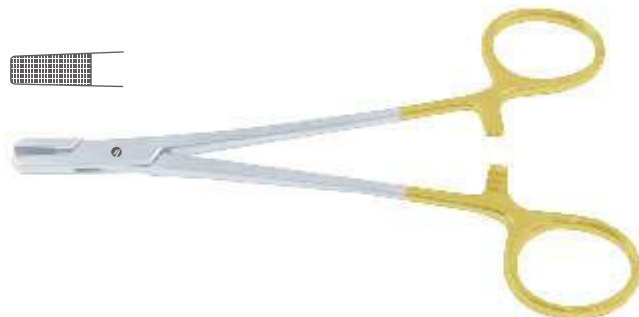



Wire Twisting Forceps  
Drahtwirbelzangen  
Pinzas para torcer alambre  
Pinces à torsader le fil  
Pinze per ritorcere fili

**UltraGrip™ TC Baumgartner Wire Twisting Forcep**



Catalog #	Size
OR-176-20	20 cm (8")



**UltraGrip™ TC Wire Twisting Forcep Curved**



Catalog #	Size
OR-177-15	14.5 cm (5 3/4")



**UltraGrip™ TC Corwin Wire Twisting Forcep**



Catalog #	Size
OR-180-16	16 cm (6 1/4")



**UltraGrip™ TC Combi Wire Twisting Forcep**



Catalog #	Size
OR-182-18	18.5 cm (7 1/4")

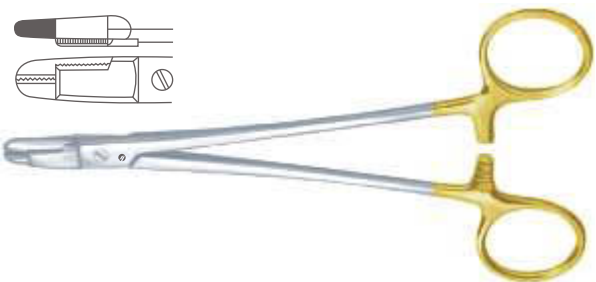

**UltraGrip™ TC Berry Wire Twisting Forcep Heavy Pattern, With Tungsten Carbide Inserts**



Catalog #	Size
OR-184-19	19 cm (7 1/2")

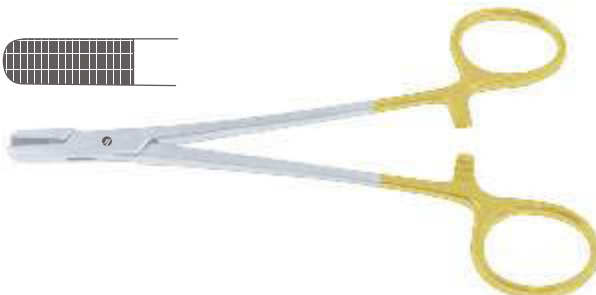



Wire Twisting Forceps, Flat Nose Pliers  
Drahtwirbelzangen, Flachzangen  
Pinzas para torcer alambre, Alicates de pico plano  
Pinces à torsader le fil, Pinces plates  
Pinze per ritorcere fili, Tenaglie piatte

**UltraGrip™ Combi-Flat Nose Plier**  
Parallel Grip, Compound Action



Catalog #	Size
OR-186-01	18 cm (7")
OR-186-02	18 cm (7")
OR-186-03	18 cm (7")

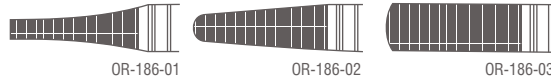

**Flat Nose Plier**

Catalog #	Size
OR-190-14	13.5 cm (5 1/4")

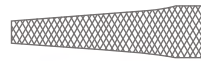

**Flat Nose Plier**

Catalog #	Size
OR-192-14	14 cm (5 1/4")



**Flat Nose Plier**

Catalog #	Size
OR-194-14	14 cm (5 1/4")



**Flat Nose Plier**

Catalog #	Size
OR-196-17	17.5 cm (7")





Flat Nose Pliers, Vise Grip, Combi-Flat Nose Plier  
 Flachzangen, Tonnenzange, Kombinationszange, Flachzangen  
 Alicates de pico plano, Alicates de pico plano, Combi-Alicate de alambre  
 Pinces plates, Pinces plates, Combi-Pince pour fils  
 Tenaglie piatte, Tenaglie piatte, Combi-Pinza per fili

**Flat Nose Plier**  
With Crosswise Groove

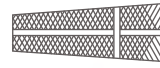

Catalog #	Size
OR-198-17	17 cm (6 3/4")

**Flat Nose Plier**  
Pointed

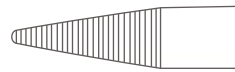

Catalog #	Size
OR-200-19	19.5 cm (7 3/4")

**Flat Nose Plier**  
With Longitudinal Groove

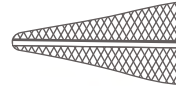

Catalog #	Size
OR-202-16	16 cm (6 1/4")

**Combi-Flat Nose Plier**  
For Bending and Cutting

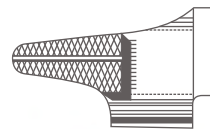

Catalog #	Size
OR-204-15	15 cm (6")

**Flat Nose Plier**  
Parallel Grip

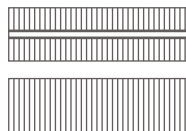

Catalog #	Size
OR-210-17	18.5 cm (7 1/4")





Flat Nose Pliers, Wire Cutting Pliers  
Flachzangen, Tonnenzange, Drahtkneifzangen  
Alicates de pico plano, Alicates para cortar alambre  
Pincers plates, Pincers plates, Pincers à couper le fil  
Tenaglie piatte, Tenaglie piatte, Tenaglie tagliafili

**Vise Grip Plier**

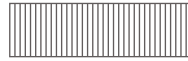

Catalog #	Size
OR-212-18	20.5 cm (8")

**Combi-Flat Nose Plier**  
Parallel Grip, Compound Action



OR-214-01

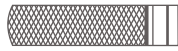

OR-214-02



OR-214-03



Catalog #	Size
OR-214-01	18 cm (7")
OR-214-02	18 cm (7")
OR-214-03	18 cm (7")

**Flat Nose Plier**

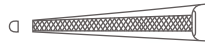

Catalog #	Size
OR-214-04	18 cm (7")

**Wire Cutting Plier**  
For Soft Wires Up to 2.4 mm Ø, For Hard Wires Up to 1.8 mm Ø



Catalog #	Size
OR-220-18	18.5 cm (7 1/4")

**Wire Cutting Plier**  
For Soft Wires Up to 2.2 mm Ø, For Hard Wires Up to 2.0 mm Ø



Catalog #	Size
OR-222-16	16 cm (6 1/4")



Wire Cutting Pliers  
Drahtkneifzangen  
Alicates para cortar alambre  
Pinces à couper le fil  
Tenaglie tagliafilì

**UltraCut™ TC Wire Cutting Plier**

For Soft Wires Up to 1.5 mm Ø, For Hard Wires Up to 1.0 mm Ø

**ULTRA.Cut™**

Catalog #	Size
OR-230-13	13 cm (5 1/4")



**UltraCut™ TC Wire Cutting Plier**

For Soft Wires Up to 3.5 mm Ø, For Hard Wires Up to 2.5 mm Ø

**ULTRA.Cut™**

Catalog #	Size
OR-232-16	16.5 cm (6 1/2")



**UltraCut™ TC Wire Cutting Plier**

For Soft Wires Up to 2.0 mm Ø, For Hard Wires Up to 1.7 mm Ø

**ULTRA.Cut™**

Catalog #	Size
OR-234-18	17.5 cm (7")



**UltraCut™ TC Wire Cutting Plier**

For Soft Wires Up to 2.8 mm Ø, For Hard Wires Up to 2.2 mm Ø

**ULTRA.Cut™**

Catalog #	Size
OR-234-22	22.5 cm (8 3/4")



**UltraCut™ TC Wire Cutting Plier**

For Soft Wires Up to 3.0 mm Ø, For Hard Wires Up to 2.2 mm Ø

**ULTRA.Cut™**

Catalog #	Size
OR-236-23	23 cm (9")





Wire Cutting Pliers, Autopsy Instruments  
Drahtkneifzangen, Autopsie Instrumente  
Alicates para cortar alambre, Instrumentos para la autopsia  
Pincers à couper le fil, Instruments pour la autopsie  
Tenaglie tagliafilii, Strumenti per autopsia

**UltraCut™ TC Wire Cutting Plier**

For Soft Wires Up to 2.0 mm Ø, For Hard Wires Up to 1.2 mm Ø



Catalog #	Size
OR-238-15	15 cm (6")



**UltraCut™ TC Wire Cutting Plier**

For Soft Wires Up to 3.0 mm Ø, For Hard Wires Up to 2.0 mm Ø



Catalog #	Size
OR-238-22	22 cm (8 3/4")

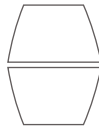

**UltraCut™ TC Wire Cutting Plier / Plate Cutter**

For Wires Up to 6 mm Ø



Catalog #	Size
OR-240-47	47 cm (18 1/2")



**Virchow Skull Breaker**

Catalog #	Blade Width
OR-250-00	15 mm



**Skull Breaker**

Catalog #	Size
OR-252-14	14 cm (5 1/2")





Autopsy Instruments  
Autopsie Instrumente  
Instrumentos para la autopsia  
Instruments pour la autopsie  
Strumenti per autopsia

**Rachietome**



Catalog #	Size
OR-254-22	22 cm (8 3/4")

**Post Mortem Chisel**



Catalog #	Size, Blade Width
OR-256-20	13 cm (5 1/4"), 20 mm
OR-256-23	13 cm (5 1/4"), 23 mm

**Brunetti Post Mortem Chisel**



Catalog #	Size, Profile
OR-258-01	28.5 cm (11 1/4"), Left
OR-258-02	28.5 cm (11 1/4"), Right

**Post Mortem Hammer  
With Hook Handle**



Catalog #	Size
OR-260-24	24 cm (9 1/2")

**Bone Chisel**



Catalog #	Size, Blade Width
OR-280-04	17 cm (6 3/4"), 4 mm



Autopsy Instruments, Bone Chisels, Gouges  
Autopsie Instrumente, Knochenmeißel, Hohlmeißel  
Instrumentos para la autopsia, Cinceles, Gubias  
Instruments pour la autopsie, Ciseaux-burins, Gouges  
Strumenti per autopsia, Scalpelli, Sgorbie

**Bone Osteotome**



Catalog #	Size, Blade Width
OR-282-04	17 cm (6 3/4"), 4 mm

**Gardner Bone Chisel**  
Triangular Shape

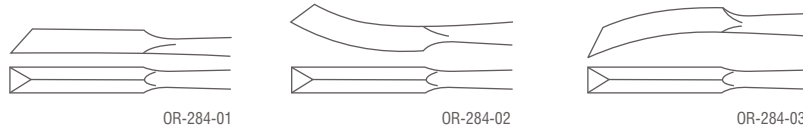

Catalog #	Size, Blade Width, Profile
OR-284-01	17 cm (6 3/4"), 4 mm
OR-284-02	17 cm (6 3/4"), 4 mm, Curved Right
OR-284-03	17 cm (6 3/4"), 4 mm, Curved Left

**Snyder-O.S.U Bone Gouge**



Catalog #	Size, Blade Width
OR-286-03	16.5 cm (6 1/2"), 3 mm
OR-286-05	16.5 cm (6 1/2"), 5 mm

**Bone Osteotome**



Catalog #	Size, Blade Width
OR-300-08	13.5 cm (5 1/4"), 8 mm
OR-300-10	13.5 cm (5 1/4"), 10 mm
OR-300-12	13.5 cm (5 1/4"), 12 mm
OR-300-14	13.5 cm (5 1/4"), 14 mm
OR-300-16	13.5 cm (5 1/4"), 16 mm



Bone Chisels, Gouges  
Knochenmeißel, Hohlmeißel  
Cinceles, Gubias  
Ciseaux-burins, Gouges  
Scalpelli, Sgorbie

**Bone Chisel**

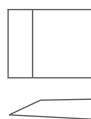

Catalog #	Size, Blade Width
OR-301-08	13.5 cm (5 1/4"), 8 mm
OR-301-10	13.5 cm (5 1/4"), 10 mm
OR-301-12	13.5 cm (5 1/4"), 12 mm
OR-301-14	13.5 cm (5 1/4"), 14 mm
OR-301-16	13.5 cm (5 1/4"), 16 mm



**Bone Gouge**



Catalog #	Size, Blade Width
OR-302-08	13.5 cm (5 1/4"), 8 mm
OR-302-10	13.5 cm (5 1/4"), 10 mm
OR-302-12	13.5 cm (5 1/4"), 12 mm
OR-302-14	13.5 cm (5 1/4"), 14 mm
OR-302-16	13.5 cm (5 1/4"), 16 mm



**Partsch Bone Chisel**

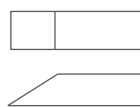

Catalog #	Size, Blade Width
OR-305-02	13.5 cm (5 1/4"), 2 mm
OR-305-03	13.5 cm (5 1/4"), 3 mm
OR-305-04	13.5 cm (5 1/4"), 4 mm
OR-305-05	13.5 cm (5 1/4"), 5 mm
OR-305-06	13.5 cm (5 1/4"), 6 mm
OR-305-07	13.5 cm (5 1/4"), 7 mm
OR-305-08	13.5 cm (5 1/4"), 8 mm





Bone Chisels, Gouges  
Knochenmeißel, Hohlmeißel  
Cinceles, Gubias  
Ciseaux-burins, Gouges  
Scalpelli, Sgorbie

**Partsch Bone Chisel**

Catalog #	Size, Blade Width
OR-306-02	17 cm (6 3/4"), 2 mm
OR-306-03	17 cm (6 3/4"), 3 mm
OR-306-04	17 cm (6 3/4"), 4 mm
OR-306-05	17 cm (6 3/4"), 5 mm
OR-306-06	17 cm (6 3/4"), 6 mm
OR-306-07	17 cm (6 3/4"), 7 mm
OR-306-08	17 cm (6 3/4"), 8 mm



**Partsch Bone Gouge**

Catalog #	Size, Blade Width
OR-309-02	13.5 cm (5 1/4"), 2 mm
OR-309-03	13.5 cm (5 1/4"), 3 mm
OR-309-04	13.5 cm (5 1/4"), 4 mm
OR-309-05	13.5 cm (5 1/4"), 5 mm
OR-309-06	13.5 cm (5 1/4"), 6 mm
OR-309-07	13.5 cm (5 1/4"), 7 mm
OR-309-08	13.5 cm (5 1/4"), 8 mm



**Partsch Bone Gouge**

Catalog #	Size, Blade Width
OR-310-02	17 cm (6 3/4"), 2 mm
OR-310-03	17 cm (6 3/4"), 3 mm
OR-310-04	17 cm (6 3/4"), 4 mm
OR-310-05	17 cm (6 3/4"), 5 mm
OR-310-06	17 cm (6 3/4"), 6 mm
OR-310-07	17 cm (6 3/4"), 7 mm
OR-310-08	17 cm (6 3/4"), 8 mm





Bone Chisels, Gouges, Osteotomes  
Knochenmeißel, Hohlmeißel, Osteotome  
Cinceles, Gubias, Osteótomos  
Ciseaux-burins, Gouges, Ostéotomes  
Scalpelli, Sgorbie, Osteotomi

**Alexander Bone Chisel**

Catalog #	Size, Blade Width
OR-314-04	17.5 cm (7"), 4 mm
OR-314-06	17.5 cm (7"), 6 mm
OR-314-08	17.5 cm (7"), 8 mm
OR-314-10	17.5 cm (7"), 10 mm
OR-314-12	17.5 cm (7"), 12 mm
OR-314-14	17.5 cm (7"), 14 mm



**Alexander Bone Gouge**

Catalog #	Size, Blade Width
OR-315-04	17.5 cm (7"), 4 mm
OR-315-06	17.5 cm (7"), 6 mm
OR-315-08	17.5 cm (7"), 8 mm
OR-315-10	17.5 cm (7"), 10 mm
OR-315-12	17.5 cm (7"), 12 mm
OR-315-14	17.5 cm (7"), 14 mm



**Mini-Lambotte Bone Osteotome**

Catalog #	Size, Blade Width
OR-320-02	12.5 cm (5"), 2 mm
OR-320-03	12.5 cm (5"), 3 mm
OR-320-04	12.5 cm (5"), 4 mm
OR-320-06	12.5 cm (5"), 6 mm
OR-320-08	12.5 cm (5"), 8 mm
OR-320-10	12.5 cm (5"), 10 mm
OR-320-12	12.5 cm (5"), 12 mm
OR-320-15	12.5 cm (5"), 15 mm







**Mini-Lambotte Bone Osteotome**

Catalog #	Size, Blade Width
OR-322-03	17 cm (6 3/4"), 3 mm
OR-322-04	17 cm (6 3/4"), 4 mm
OR-322-06	17 cm (6 3/4"), 6 mm
OR-322-08	17 cm (6 3/4"), 8 mm
OR-322-10	17 cm (6 3/4"), 10 mm
OR-322-12	17 cm (6 3/4"), 12 mm
OR-322-15	17 cm (6 3/4"), 15 mm



**Lambotte Bone Osteotome**

Catalog #	Size, Blade Width
OR-324-15	24 cm (9 1/2"), 15 mm
OR-324-20	24 cm (9 1/2"), 20 mm
OR-324-25	24 cm (9 1/2"), 25 mm
OR-324-30	24 cm (9 1/2"), 30 mm
OR-324-38	24 cm (9 1/2"), 38 mm
OR-320-44	24 cm (9 1/2"), 44 mm
OR-320-50	24 cm (9 1/2"), 50 mm

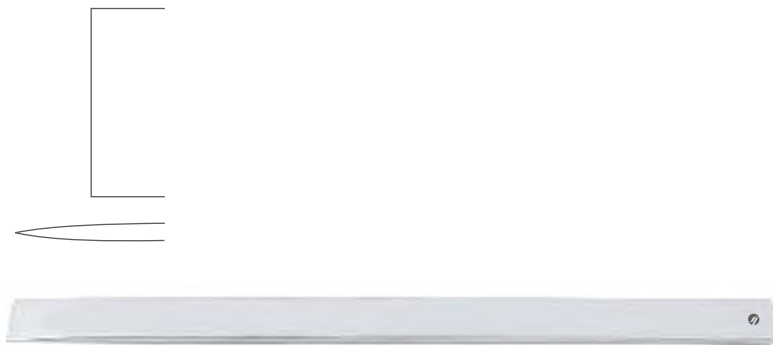

**Lambotte Bone Osteotome  
Curved**

Catalog #	Size, Blade Width
OR-325-15	24 cm (9 1/2"), 15 mm
OR-325-20	24 cm (9 1/2"), 20 mm
OR-325-25	24 cm (9 1/2"), 25 mm
OR-325-30	24 cm (9 1/2"), 30 mm
OR-325-38	24 cm (9 1/2"), 38 mm
OR-325-44	24 cm (9 1/2"), 44 mm
OR-325-50	24 cm (9 1/2"), 50 mm

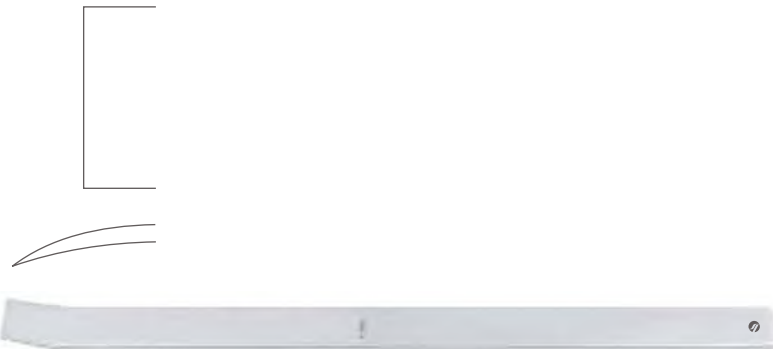



Chisels, Osteotomes, Gouges  
 Flachmeißel, Osteotome, Hohlmeißel  
 Cinceles, Osteótomos, Gubias  
 Ciseaux-burins, Ostéotomes, Gouges  
 Scalpelli, Osteotomi, Sgorbie

**Stille Bone Chisel**

Catalog #	Size, Blade Width
OR-328-10	20 cm (8"), 10 mm
OR-328-15	20 cm (8"), 15 mm
OR-328-20	20 cm (8"), 20 mm
OR-328-25	20 cm (8"), 25 mm

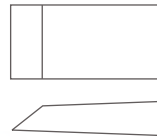

**Stille Bone Osteotome**

Catalog #	Size, Blade Width
OR-329-10	20 cm (8"), 10 mm
OR-329-15	20 cm (8"), 15 mm
OR-329-20	20 cm (8"), 20 mm
OR-329-25	20 cm (8"), 25 mm



**Stille Bone Gouge**

Catalog #	Size, Blade Width
OR-330-10	20 cm (8"), 10 mm
OR-330-15	20 cm (8"), 15 mm
OR-330-20	20 cm (8"), 20 mm
OR-330-25	20 cm (8"), 25 mm

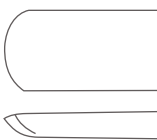

**Smith-Peterson Bone Osteotome**

Catalog #	Size, Blade Width
OR-332-06	20.5 cm (8"), 6 mm
OR-332-09	20.5 cm (8"), 9 mm
OR-332-13	20.5 cm (8"), 13 mm
OR-332-16	20.5 cm (8"), 16 mm
OR-332-19	20.5 cm (8"), 19 mm
OR-332-25	20.5 cm (8"), 25 mm
OR-332-32	20.5 cm (8"), 32 mm

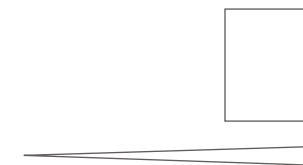



Osteotomes, Gouges  
Osteotome, Hohlmeißel  
Osteótomos, Gubias  
Ostéotomes, Gouges  
Osteotomi, Sgorbie

**Smith-Peterson Bone Osteotome**  
Curved

Catalog #	Size, Blade Width
OR-333-06	20.5 cm (8"), 6 mm
OR-333-09	20.5 cm (8"), 9 mm
OR-333-13	20.5 cm (8"), 13 mm
OR-333-16	20.5 cm (8"), 16 mm
OR-333-19	20.5 cm (8"), 19 mm
OR-333-25	20.5 cm (8"), 25 mm
OR-333-32	20.5 cm (8"), 32 mm



**Smith-Peterson Bone Gouge**

Catalog #	Size, Blade Width
OR-334-09	20.5 cm (8"), 9 mm
OR-334-14	20.5 cm (8"), 14 mm
OR-334-19	20.5 cm (8"), 19 mm
OR-334-25	20.5 cm (8"), 25 mm



**Smith-Peterson Bone Gouge**  
Curved

Catalog #	Size, Blade Width
OR-335-09	20.5 cm (8"), 9 mm
OR-335-14	20.5 cm (8"), 14 mm
OR-335-19	20.5 cm (8"), 19 mm
OR-335-25	20.5 cm (8"), 25 mm

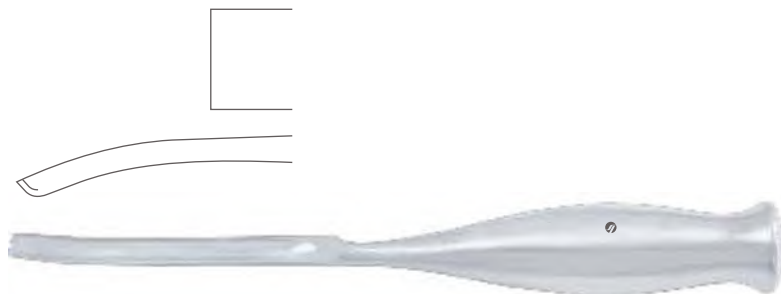



Osteotomes, Chisels  
Osteotome, Flachmeißel  
Osteótomos, Cinceles  
Ostéotomes, Ciseaux-burins  
Osteotomi, Scalpelli

**Hoke Bone Osteotome**

Catalog #	Size, Blade Width
OR-338-03	17 cm (6 3/4"), 3 mm
OR-338-05	17 cm (6 3/4"), 5 mm
OR-338-06	17 cm (6 3/4"), 6 mm
OR-338-08	17 cm (6 3/4"), 8 mm
OR-338-09	17 cm (6 3/4"), 9 mm



**Hibbs Bone Osteotome**

Catalog #	Size, Blade Width
OR-340-06	24.5 cm (9 3/4"), 6 mm
OR-340-13	24.5 cm (9 3/4"), 13 mm
OR-340-19	24.5 cm (9 3/4"), 19 mm
OR-340-25	24.5 cm (9 3/4"), 25 mm
OR-340-32	24.5 cm (9 3/4"), 32 mm



**Hibbs Bone Osteotome  
Curved**

Catalog #	Size, Blade Width
OR-341-06	24.5 cm (9 3/4"), 6 mm
OR-341-13	24.5 cm (9 3/4"), 13 mm
OR-341-19	24.5 cm (9 3/4"), 19 mm
OR-341-25	24.5 cm (9 3/4"), 25 mm
OR-341-32	24.5 cm (9 3/4"), 32 mm



**Hibbs Bone Chisel**

Catalog #	Size, Blade Width
OR-342-06	24.5 cm (9 3/4"), 6 mm
OR-342-13	24.5 cm (9 3/4"), 13 mm
OR-342-19	24.5 cm (9 3/4"), 19 mm
OR-342-25	24.5 cm (9 3/4"), 25 mm
OR-342-32	24.5 cm (9 3/4"), 32 mm





Gouges, Osteotomes  
Hohlmeißel, Osteotome  
Gubias, Osteótomos  
Gouges, Osteótomos  
Sgorbie, Osteotomi

**Hibbs Bone Gouge**  
Curved

Catalog #	Size, Blade Width
OR-343-06	24.5 cm (9 3/4"), 6 mm
OR-343-13	24.5 cm (9 3/4"), 13 mm
OR-343-19	24.5 cm (9 3/4"), 19 mm
OR-343-25	24.5 cm (9 3/4"), 25 mm
OR-343-32	24.5 cm (9 3/4"), 32 mm

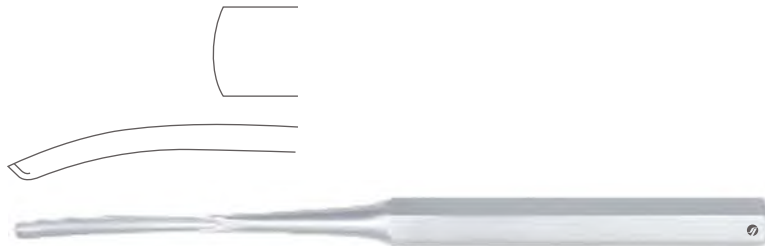

**Hibbs Bone Gouge**

Catalog #	Size, Blade Width
OR-344-06	24.5 cm (9 3/4"), 6 mm
OR-344-13	24.5 cm (9 3/4"), 13 mm
OR-344-19	24.5 cm (9 3/4"), 19 mm
OR-344-25	24.5 cm (9 3/4"), 25 mm
OR-344-32	24.5 cm (9 3/4"), 32 mm



**Cloward Bone Osteotome**

Catalog #	Size, Blade Width
OR-346-05	24.5 cm (9 3/4"), 5 mm
OR-346-06	24.5 cm (9 3/4"), 6 mm
OR-346-07	24.5 cm (9 3/4"), 7 mm
OR-346-08	24.5 cm (9 3/4"), 8 mm
OR-346-10	24.5 cm (9 3/4"), 10 mm
OR-346-15	24.5 cm (9 3/4"), 15 mm





Gouges  
Hohlmeißel  
Gubias  
Gouges  
Sgorbie

**Cloward Bone Gouge**

Catalog #	Size, Blade Width
OR-348-05	24.5 cm (9 3/4"), 5 mm
OR-348-06	24.5 cm (9 3/4"), 6 mm
OR-348-07	24.5 cm (9 3/4"), 7 mm
OR-348-08	24.5 cm (9 3/4"), 8 mm
OR-348-10	24.5 cm (9 3/4"), 10 mm
OR-348-15	24.5 cm (9 3/4"), 15 mm



**FiberGrip™ Lexer Bone Gouge**

**FIBERGrip™**

Catalog #	Size, Blade Width
OR-356-05	25 cm (9 3/4"), 5 mm
OR-356-10	25 cm (9 3/4"), 10 mm
OR-356-15	25 cm (9 3/4"), 15 mm



**FiberGrip™ Lexer Bone Gouge  
Curved**

**FIBERGrip™**

Catalog #	Size, Blade Width
OR-357-05	25 cm (9 3/4"), 5 mm
OR-357-10	25 cm (9 3/4"), 10 mm
OR-357-15	25 cm (9 3/4"), 15 mm



**FiberGrip™ Mini-Lexer Bone Osteotome**

**FIBERGrip™**

Catalog #	Size, Blade Width
OR-360-04	18.5 cm (7 1/4"), 4 mm
OR-360-06	18.5 cm (7 1/4"), 6 mm
OR-360-08	18.5 cm (7 1/4"), 8 mm
OR-360-10	18.5 cm (7 1/4"), 10 mm
OR-360-12	18.5 cm (7 1/4"), 12 mm





Gouges, Bone Chisels, Osteotomes  
Hohlmeißel, Knochenmeißel, Osteotome  
Gubias, Cinceles, Osteótomos  
Gouges, Ciseaux-burins, Ostéotomes  
Sgorbie, Scalpelli, Osteotomi

**FiberGrip™ Mini-Lexer Bone Gouge**

**FIBER***Grip*™

Catalog #	Size, Blade Width
OR-362-04	18.5 cm (7 ¼"), 4 mm
OR-362-06	18.5 cm (7 ¼"), 6 mm
OR-362-08	18.5 cm (7 ¼"), 8 mm
OR-362-10	18.5 cm (7 ¼"), 10 mm
OR-362-12	18.5 cm (7 ¼"), 12 mm



**FiberGrip™ Lexer Bone Chisel**

**FIBER***Grip*™

Catalog #	Size, Blade Width
OR-364-10	20 cm (8"), 10 mm
OR-364-15	20 cm (8"), 15 mm
OR-364-20	20 cm (8"), 20 mm



**FiberGrip™ Lexer Bone Chisel**  
Curved

**FIBER***Grip*™

Catalog #	Size, Blade Width
OR-365-10	20 cm (8"), 10 mm
OR-365-15	20 cm (8"), 15 mm
OR-365-20	20 cm (8"), 20 mm

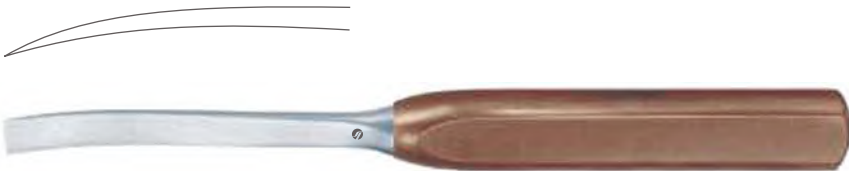

**FiberGrip™ Lexer Bone Osteotome**

**FIBER***Grip*™

Catalog #	Size, Blade Width
OR-366-07	22 cm (8 ¾"), 7 mm
OR-366-10	22 cm (8 ¾"), 10 mm
OR-366-15	22 cm (8 ¾"), 15 mm
OR-366-20	22 cm (8 ¾"), 20 mm
OR-366-25	22 cm (8 ¾"), 25 mm
OR-366-30	22 cm (8 ¾"), 30 mm





Gouges, Bone Chisels, Osteotomes  
Hohlmeißel, Knochenmeißel, Osteotome  
Gubias, Cinceles, Osteótomos  
Gouges, Ciseaux-burins, Ostéotomes  
Sgorbie, Scalpelli, Osteotomi

**FiberGrip™ Lexer Bone Gouge**

**FIBERGrip™**

Catalog #	Size, Blade Width
OR-368-07	22 cm (8 3/4"), 7 mm
OR-368-10	22 cm (8 3/4"), 10 mm
OR-368-15	22 cm (8 3/4"), 15 mm
OR-368-20	22 cm (8 3/4"), 20 mm
OR-368-25	22 cm (8 3/4"), 25 mm
OR-368-30	22 cm (8 3/4"), 30 mm



**FiberGrip™ Lexer Bone Osteotome**  
Angled

**FIBERGrip™**

Catalog #	Size, Blade Width
OR-371-10	27.5 cm (10 3/4"), 10 mm
OR-371-15	27.5 cm (10 3/4"), 15 mm



**FiberGrip™ Lexer Bone Gouge**  
Angled

**FIBERGrip™**

Catalog #	Size, Blade Width
OR-373-10	27.5 cm (10 3/4"), 10 mm
OR-373-15	27.5 cm (10 3/4"), 15 mm

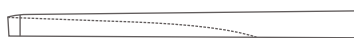

**FiberGrip™ Bone Chisel**

**FIBERGrip™**

Catalog #	Size, Blade Width
OR-376-24	24.5 cm (9 3/4"), 20 mm



**FiberGrip™ Bone Chisel**  
Curved

**FIBERGrip™**

Catalog #	Size, Blade Width
OR-377-26	26.5 cm (10 1/2"), 16 mm







Gouges  
Hohlmeißel  
Gubias  
Gouges  
Sgorbie

OR

BONE SURGERY

**FiberGrip™ Wagner Bone Gouge**  
Sraight

**FIBER**Grip™



Catalog #	Size, Blade Width
OR-390-09	34 cm (13 1/2"), 9 mm
OR-390-15	34 cm (13 1/2"), 15 mm



**FiberGrip™ Wagner Bone Gouge**  
Curved Forward

**FIBER**Grip™



Catalog #	Size, Blade Width
OR-391-09	34 cm (13 1/2"), 9 mm
OR-391-15	34 cm (13 1/2"), 15 mm



**FiberGrip™ Wagner Bone Gouge**  
Curved Backward

**FIBER**Grip™



Catalog #	Size, Blade Width
OR-393-09	34 cm (13 1/2"), 9 mm
OR-393-15	34 cm (13 1/2"), 15 mm



**FiberGrip™ Bone Gouge**

**FIBER**Grip™

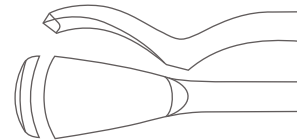

Catalog #	Size, Blade Width
OR-395-29	25 cm (9 3/4"), 25 mm



**FiberGrip™ Cobb Bone Gouge**

**FIBER**Grip™



Catalog #	Size, Blade Width
OR-398-28	28 cm (11"), 8 mm



Gouges  
Hohlmeißel  
Gubias  
Gouges  
Sgorbie

**FiberGrip™ Cobb Bone Gouge**

**FIBERGrip™**

Catalog #	Size, Blade Width
OR-399-01	28 cm (11"), 8 mm
OR-399-02	28 cm (11"), 8 mm
OR-399-03	28 cm (11"), 8 mm



**FiberGrip™ Bone Gouge**

**FIBERGrip™**

Catalog #	Size, Blade Width
OR-402-22	22 cm (8 3/4"), 9 mm



**FiberGrip™ Zielke Bone Gouge**

**FIBERGrip™**

Catalog #	Size, Blade Width
OR-405-55	23 cm (9"), 5.5 mm
OR-405-90	23.5 cm (9 1/4"), 9 mm

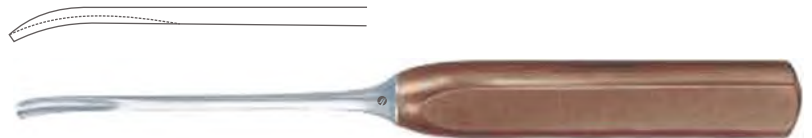

**FiberGrip™ Zielke Bone Gouge**

**FIBERGrip™**

Catalog #	Size, Blade Width
OR-407-06	23.5 cm (9 1/4"), 6 mm
OR-407-08?	23.5 cm (9 1/4"), 8 mm
OR-407-11	23.5 cm (9 1/4"), 11 mm
OR-407-16	23.5 cm (9 1/4"), 16 mm





**FiberGrip™ Dahmen Bone Osteotome**

**FIBERGrip™**

Catalog #	Size, Blade Width
OR-410-04	30 cm (12"), 4 mm
OR-410-05	30 cm (12"), 5 mm
OR-410-06?	30 cm (12"), 6 mm
OR-410-08	30 cm (12"), 8 mm
OR-410-10	30 cm (12"), 10 mm
OR-410-12	30 cm (12"), 12 mm
OR-410-15?	30 cm (12"), 15 mm
OR-410-20	30 cm (12"), 20 mm
OR-410-22	30 cm (12"), 22 mm
OR-410-25	30 cm (12"), 25 mm



**FiberGrip™ Dahmen Bone Osteotome**  
Curved

**FIBERGrip™**

Catalog #	Size, Blade Width
OR-411-04	30 cm (12"), 4 mm
OR-411-05	30 cm (12"), 5 mm
OR-411-06?	30 cm (12"), 6 mm
OR-411-08	30 cm (12"), 8 mm
OR-411-10	30 cm (12"), 10 mm
OR-411-12	30 cm (12"), 12 mm
OR-411-15?	30 cm (12"), 15 mm
OR-411-20	30 cm (12"), 20 mm
OR-411-22	30 cm (12"), 22 mm
OR-411-25	30 cm (12"), 25 mm





Gouges, Bone Rasps  
Hohlmeißel, Knochenraspeln  
Gubias, Escofinas para hueso  
Gouges, Râpes pour os  
Sgorbie, Raspe per ossa

**FiberGrip™ Dahmen Bone Gouge**

**FIBERGrip™**

Catalog #	Size, Blade Width
OR-412-04	30 cm (12"), 4 mm
OR-412-05	30 cm (12"), 5 mm
OR-412-06?	30 cm (12"), 6 mm
OR-412-08	30 cm (12"), 8 mm
OR-412-10	30 cm (12"), 10 mm
OR-412-12	30 cm (12"), 12 mm
OR-412-15?	30 cm (12"), 15 mm
OR-412-20	30 cm (12"), 20 mm
OR-412-22	30 cm (12"), 22 mm
OR-412-25	30 cm (12"), 25 mm



**FiberGrip™ Dahmen Bone Gouge  
Curved**

**FIBERGrip™**

Catalog #	Size, Blade Width
OR-413-04	30 cm (12"), 4 mm
OR-413-05	30 cm (12"), 5 mm
OR-413-06?	30 cm (12"), 6 mm
OR-413-08	30 cm (12"), 8 mm
OR-413-10	30 cm (12"), 10 mm
OR-413-12	30 cm (12"), 12 mm
OR-413-15?	30 cm (12"), 15 mm
OR-413-20	30 cm (12"), 20 mm
OR-413-22	30 cm (12"), 22 mm
OR-413-25	30 cm (12"), 25 mm

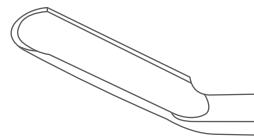

**Putti Bone Rasp  
Round, Semi Round**

Catalog #	Size
OR-421-30	30 cm (11 3/4")





Bone Rasps, Tampers  
Knochenraspeln, Stößel  
Escofinas para hueso, Punzones metálicos  
Râpes pour os, Pignons métalliques  
Raspe per ossa, Pestoni metallici

**Putti Bone Rasp**  
Curved, Straight

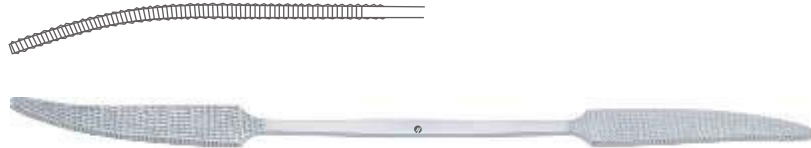

Catalog #	Size
OR-423-27	27 cm (10 3/4")

**Bone File**  
Semi Round

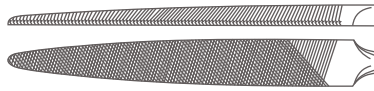

Catalog #	Size
OR-426-28	28 cm (11")

**Bone File**  
Semi Round



Catalog #	Size
OR-427-24	24.5 cm (9 3/4")

**Bone File**  
Flat



Catalog #	Size
OR-430-22	22 cm (8 3/4")



Tampers, Mallets  
Stößel, Hämmer  
Punzones metálicos, Martillos  
Pilons métalliques, Maillets  
Pestoni metallici, Martelli

**Passow Bone Tamper**



Catalog #	Size, Tip Size
OR-438-25	12 cm (4 3/4"), 2.5 mm
OR-438-35	12 cm (4 3/4"), 3.5 mm



**Bone Tamper**

Catalog #	Size, Diameter
OR-440-02	15 cm (6"), Ø 2.0 mm
OR-440-03	15 cm (6"), Ø 3.0 mm
OR-440-04	15 cm (6"), Ø 4.0 mm
OR-440-05	15 cm (6"), Ø 5.0 mm
OR-440-06	15 cm (6"), Ø 6.0 mm
OR-440-08	15 cm (6"), Ø 8.0 mm
OR-440-10	15 cm (6"), Ø 10.0 mm



**Caspar Bone Tamper**

Catalog #	Size, Diameter
OR-442-03	20 cm (8"), Ø 2.0 mm
OR-442-05	20 cm (8"), Ø 5.0 mm
OR-442-08	20 cm (8"), Ø 8.0 mm



**Bone Tamper**

Catalog #	Size, Diameter
OR-444-12	20 cm (8"), Ø 12.0 mm
OR-444-14	20 cm (8"), Ø 14.0 mm
OR-444-16	20 cm (8"), Ø 16.0 mm





Mallets  
Hämmer  
Martillos  
Maillets  
Martelli

OR

BONE SURGERY

**Williger Bone Mallet**  
Lead Filled



Catalog #	Size, Head Diameter, Weight
OR-450-01	24 cm (9 1/2"), Ø 26.0 mm, 300 Grams
OR-450-02	24 cm (9 1/2"), Ø 28.0 mm, 340 Grams
OR-450-03	24 cm (9 1/2"), Ø 30.0 mm, 400 Grams

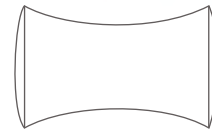

**Doyen Bone Mallet**



Catalog #	Size, Head Diameter, Weight
OR-452-01	20.5 cm (8"), Ø 25.0 mm, 120 Grams
OR-452-02	21 cm (8 1/4"), Ø 30.0 mm, 180 Grams
OR-452-03	21.5 cm (8 1/2"), Ø 35.0 mm, 260 Grams

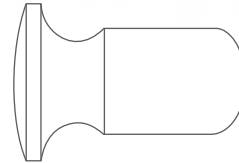

**Collin Bone Mallet**



Catalog #	Size, Head Diameter, Weight
OR-454-20	20 cm (8"), Ø 30.0 mm, 220 Grams

**Hajek Bone Mallet**



Catalog #	Size, Head Diameter, Weight
OR-458-21	2.5 cm (8 1/2"), Ø 27.0 mm, 140 Grams

**Gerzog Bone Mallet**



Catalog #	Size, Head Diameter, Weight
OR-460-17	19 cm (7 1/2"), Ø 25.0 mm, 225 Grams



Mallets  
Hämmer  
Martillos  
Maillets  
Martelli

**Lucae Bone Mallet**

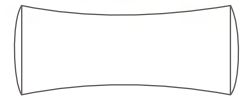

Catalog #	Size, Head Diameter, Weight
OR-462-01	19.5 cm (7 3/4"), Ø 19.0 mm, 230 Grams
OR-462-02	19.5 cm (7 3/4"), Ø 25.0 mm, 260 Grams

**Bergmann Bone Mallet**



Catalog #	Size, Head Diameter, Weight
OR-464-24	24 cm (9 1/2"), Ø 45.0 mm, 300 Grams

**Bergmann Bone Mallet**



Catalog #	Size, Head Diameter, Weight
OR-466-24	23.5 cm (9 1/4"), Ø 30.0 mm, 245 Grams

**Bone Mallet**



Catalog #	Size, Head Diameter 1, Head Diameter, Weight
OR-468-24	24 cm (9 1/2"), Ø 30.0 mm, Ø 42.0 mm, 285 Grams

**Cottle Bone Mallet**  
Plain, Convex



Catalog #	Size, Head Diameter, Weight
OR-470-19	19 cm (7 1/2"), Ø 30.0 mm, 300 Grams





Tampers, Mallets  
Stößel, Hämmer  
Punzones metálicos, Martillos  
Pilons métalliques, Maillets  
Pestoni metallici, Martelli

**Omberdanne Bone Mallet**



Catalog #	Size, Head Diameter, Weight
OR-472-24	24 cm (9 1/2"), Ø 40.0 mm, 520 Grams

**Heath Bone Mallet**



Catalog #	Size, Head Diameter, Weight
OR-474-18	18.5 cm (7 1/4"), Ø 40.0 mm, 660 Grams
OR-474-20	20 cm (8"), Ø 45.0 mm, 725 Grams

**Williger Bone Mallet**



Catalog #	Size, Head Diameter, Weight
OR-476-16	16.5 cm (6 1/2"), Ø 20.0 mm, 140 Grams

**Mead Bone Mallet**  
With Interchangeable Plastic Discs



Catalog #	Size, Head Diameter, Weight
OR-478-16	19 cm (7 1/2"), Ø 27.0 mm, 320 Grams

**Mallet Spare Plastic Discs**  
Pair, Plastic



Catalog #	Size
OR-478-90	Standard



Mallets  
Hämmer  
Martillos  
Maillets  
Martelli

**Partsch Mallet**  
With Hollow Handle



Catalog #	Size, Head Diameter, Weight
OR-480-18	19 cm (7 1/2"), Ø 22.0 mm, 200 Grams

**FiberGrip™ Bone Mallet**  
With Plastic Handle

**FIBERGrip™**



Catalog #	Size, Head Diameter, Weight
OR-486-22	26 cm (10 1/4"), Ø 30.0 mm, 510 Grams

**FiberGrip™ Bone Mallet**  
With Lead Filling, Ferrozell

**FIBERGrip™**



Catalog #	Size, Head Diameter, Weight
OR-488-01	26 cm (10 1/4"), Ø 42.0 mm, 400 Grams

**FiberGrip™ Bone Mallet**  
Without Lead Filling, Ferrozell

**FIBERGrip™**



Catalog #	Size, Head Diameter, Weight
OR-488-02	26 cm (10 1/4"), Ø 42.0 mm, 250 Grams

**FiberGrip™ Bone Mallet**  
With Lead Filling, Ferrozell

**FIBERGrip™**



Catalog #	Size, Head Diameter, Weight
OR-490-26	26 cm (10 1/4"), Ø 42.0 mm, 400 Grams



Mallets  
Hämmer  
Martillos  
Maillets  
Martelli

OR

BONE SURGERY

**FiberGrip™ Bone Mallet**

Plane (Nylon), Convex (Stainless Steel)



Catalog #	Size, Head Diameter, Weight
OR-492-29	26.5 cm (10 1/2"), Ø 30.0 mm, 675 Grams

**FiberGrip™ Bone Mallet**



Catalog #	Size, Head Diameter 1, Head Diameter 2, Weight
OR-494-24	26 cm (10 1/4"), Ø 42.0 mm, 30.0 mm, 530 Grams

**FiberGrip™ Bone Mallet**



Catalog #	Size, Head Diameter, Weight
OR-496-24	24 cm (9 1/2"), Ø 30.0 mm, 480 Grams

**FiberGrip™ Bone Mallet**

With Interchangeable Plastic Discs



Catalog #	Size, Head Diameter, Weight
OR-498-22	24 cm (9 1/2"), Ø 37.0 mm, 370 Grams

**Mallet Spare Plastic Discs**

Pair, Plastic



Catalog #	Size
OR-498-90	Standard



Mallets  
Hämmer  
Martillos  
Maillets  
Martelli

**FiberGrip™ Bone Mallet**

**FIBERGrip™**



Catalog #	Size, Head Diameter, Weight
OR-500-18	22 cm (8 ¾"), Ø 30.0 mm, 125 Grams

**FiberGrip™ Bone Mallet**

**FIBERGrip™**



Catalog #	Size, Head Diameter, Weight
OR-502-01	26 cm (10 ½"), Ø 30.0 mm, 450 Grams
OR-502-02	26 cm (10 ½"), Ø 50.0 mm, 900 Grams

**FiberGrip™ Vickers Bone Mallet**  
With Interchangeable Nylon Discs

**FIBERGrip™**



Catalog #	Size, Head Diameter, Weight
OR-504-19	19 cm (7 ½"), Ø 25.0 mm, 300 Grams

**Mallet Spare Plastic Discs**  
Pair, Plastic

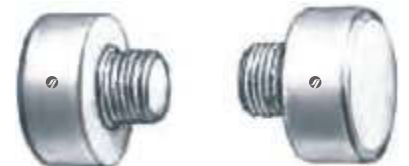

Catalog #	Size
OR-504-90	Standard

**FiberGrip™ Herbert Bone Mallet**

**FIBERGrip™**



Catalog #	Size
OR-506-19	19 cm (7 ½")



Bone Currettes  
Scharfe Löffel  
Cucharillas cortantes  
Currettes tranchantes  
Curette taglianti

OR

BONE SURGERY

**FiberGrip™ Volkmann Bone Curette**  
Oval



Catalog #	Size, Profile
OR-520-40	18.5 cm (7 1/4"), Fig. 0000
OR-520-30	18.5 cm (7 1/4"), Fig. 000
OR-520-20	18.5 cm (7 1/4"), Fig. 00
OR-520-10	18.5 cm (7 1/4"), Fig. 0
OR-520-01	18.5 cm (7 1/4"), Fig. 1
OR-520-02	18.5 cm (7 1/4"), Fig. 2
OR-520-03	19 cm (7 1/2"), Fig. 3
OR-520-04	19 cm (7 1/2"), Fig. 4
OR-520-05	19 cm (7 1/2"), Fig. 5
OR-520-06	19 cm (7 1/2"), Fig. 6



**FiberGrip™ Volkmann Bone Curette**  
Oval



Catalog #	Size, Profile
OR-522-10	27.5 cm (10 3/4"), Fig. 4
OR-522-01	27.5 cm (10 3/4"), Fig. 0
OR-522-02	27.5 cm (10 3/4"), Fig. 1
OR-522-03	27.5 cm (10 3/4"), Fig. 2
OR-522-04	27.5 cm (10 3/4"), Fig. 3



**Schede Bone Curette**  
Oval

Catalog #	Size, Scoop Size, Profile
OR-524-30	17 cm (6 3/4"), 2.5 mm, Fig. 000
OR-524-20	17 cm (6 3/4"), 3.4 mm, Fig. 00
OR-524-10	17 cm (6 3/4"), 4.2 mm, Fig. 0
OR-524-01	17 cm (6 3/4"), 5.2 mm, Fig. 1
OR-524-02	17 cm (6 3/4"), 6.3 mm, Fig. 2
OR-524-03	17 cm (6 3/4"), 7.4 mm, Fig. 3
OR-524-04	17 cm (6 3/4"), 8 mm, Fig. 4





Bone Curettes  
Scharfe Löffel  
Cucharillas cortantes  
Curettes tranchantes  
Curette taglienti

**Volkman Bone Curette**  
Oval

Catalog #	Size, Scoop Size, Profile
OR-526-40	17 cm (6 3/4"), 2.8 mm, Fig. 0000
OR-526-30	17 cm (6 3/4"), 3.6 mm, Fig. 000
OR-526-20	17 cm (6 3/4"), 4.4 mm, Fig. 00
OR-526-10	17 cm (6 3/4"), 5.2 mm, Fig. 0
OR-526-01	17 cm (6 3/4"), 6.8 mm, Fig. 1
OR-526-02	17 cm (6 3/4"), 8.5 mm, Fig. 2
OR-526-03	17 cm (6 3/4"), 10 mm, Fig. 3
OR-526-04	17 cm (6 3/4"), 11.5 mm, Fig. 4
OR-526-05	17 cm (6 3/4"), 13 mm, Fig. 5
OR-526-06	17 cm (6 3/4"), 14.5 mm, Fig. 6



**Bruns Bone Curette**  
Round

Catalog #	Size, Scoop Size, Profile
OR-528-30	17 cm (6 3/4"), 3 mm, Fig. 000
OR-528-20	17 cm (6 3/4"), 4 mm, Fig. 00
OR-528-10	17 cm (6 3/4"), 5 mm, Fig. 0
OR-528-01	17 cm (6 3/4"), 6 mm, Fig. 1
OR-528-02	17 cm (6 3/4"), 8 mm, Fig. 2
OR-528-03	17 cm (6 3/4"), 10 mm, Fig. 3
OR-528-04	17 cm (6 3/4"), 12 mm, Fig. 4



**Spratt Bone Curette**  
Oval

Catalog #	Size, Profile
OR-530-40	17 cm (6 3/4"), Fig. 0000
OR-530-30	17 cm (6 3/4"), Fig. 000
OR-530-20	17 cm (6 3/4"), Fig. 00
OR-530-10	17 cm (6 3/4"), Fig. 0
OR-530-01	17 cm (6 3/4"), Fig. 1
OR-530-02	17 cm (6 3/4"), Fig. 2
OR-530-03	17 cm (6 3/4"), Fig. 3
OR-530-04	17 cm (6 3/4"), Fig. 4
OR-530-05	17 cm (6 3/4"), Fig. 5





Bone Curettes  
Scharfe Löffel  
Cucharillas cortantes  
Curettes tranchantes  
Curette taglianti

OR

BONE SURGERY

**Bruns Bone Curette**  
Oval, Solid Handle

Catalog #	Size, Scoop Size, Profile
OR-532-30	23 cm (9"), 2.0 mm, Fig. 000
OR-532-20	23 cm (9"), 2.5 mm, Fig. 00
OR-532-10	23 cm (9"), 3.3 mm, Fig. 0
OR-532-01	23 cm (9"), 3.8 mm, Fig. 1
OR-532-02	23 cm (9"), 4.8 mm, Fig. 2
OR-532-03	23 cm (9"), 5.3 mm, Fig. 3
OR-532-04	23 cm (9"), 6.0 mm, Fig. 4
OR-532-05	23 cm (9"), 6.7 mm, Fig. 5
OR-532-06	23 cm (9"), 7.3 mm, Fig. 6



**Scoville Bone Curette**  
Oval

Catalog #	Size, Scoop Size, Profile
OR-534-30	25 cm (9 3/4"), 3.6 mm, Fig. 000
OR-534-20	25 cm (9 3/4"), 4.4 mm, Fig. 00
OR-534-10	25 cm (9 3/4"), 6.8 mm, Fig. 0
OR-534-01	25 cm (9 3/4"), 5.2 mm, Fig. 1



**Scoville Bone Curette**  
Oval, Curved Downwards

Catalog #	Size, Scoop Size, Profile
OR-535-30	25 cm (9 3/4"), 3.6 mm, Fig. 000
OR-535-20	25 cm (9 3/4"), 4.4 mm, Fig. 00
OR-535-10	25 cm (9 3/4"), 5.2 mm, Fig. 0
OR-535-01	25 cm (9 3/4"), 6.8 mm, Fig. 1





Bone Curettes  
Scharfe Löffel  
Cucharillas cortantes  
Curettes tranchantes  
Curette taglianti

**Scoville Bone Curette**  
Oval, Curved Upwards



Catalog #	Size, Scoop Size
OR-537-01	25 cm (9 3/4"), 4mm
OR-537-02	25 cm (9 3/4"), 3mm
OR-537-03	25 cm (9 3/4"), 5 mm



**Simon Bone Curette**  
Oval



Catalog #	Size, Scoop Size, Profile
OR-538-30	25 cm (9 3/4"), 3.6 mm, Fig. 000
OR-538-20	25 cm (9 3/4"), 4.4 mm, Fig. 00
OR-538-10	25 cm (9 3/4"), 5.2 mm, Fig. 0
OR-538-01	25 cm (9 3/4"), 6.8 mm, Fig. 1
OR-538-02	25 cm (9 3/4"), 8.5 mm, Fig. 2
OR-538-03	25 cm (9 3/4"), 10 mm, Fig. 3
OR-538-04	25 cm (9 3/4"), 11.5 mm, Fig. 4
OR-538-05	25 cm (9 3/4"), 13 mm, Fig. 5
OR-538-06	25 cm (9 3/4"), 14.5 mm, Fig. 6



**Caspar Bone Curette**  
Rectangular, Toothed



Catalog #	Size, Scoop Size
OR-540-01	25 cm (9 3/4"), 4 mm
OR-540-02	25 cm (9 3/4"), 5 mm



**Caspar Bone Curette**  
Angled, Rectangular, Toothed



Catalog #	Size, Scoop Size
OR-541-01	27 cm (10 3/4"), 3 mm
OR-541-02	27 cm (10 3/4"), 4 mm







Bone Currettes  
Scharfe Löffel  
Cucharillas cortantes  
Curettes tranchantes  
Curette taglianti

**Hatfield Bone Curette**  
Oval

Catalog #	Size, Scoop Size
OR-542-01	23 cm (9"), 5.0 mm
OR-542-02	23 cm (9"), 5.5 mm
OR-542-03	23 cm (9"), 6.4 mm
OR-542-04	23 cm (9"), 8.0 mm
OR-542-05	23 cm (9"), 9.0 mm
OR-542-06	23 cm (9"), 11.0 mm
OR-542-07	23 cm (9"), 12.5 mm
OR-542-08	23 cm (9"), 14.5 mm
OR-542-09	23 cm (9"), 16.8 mm



**Cobb Bone Curette**  
Oval

Catalog #	Size, Scoop Size
OR-544-01	28 cm (11"), 5.0 mm
OR-544-02	28 cm (11"), 6.3 mm
OR-544-03	28 cm (11"), 7.6 mm
OR-544-04	28 cm (11"), 8.9 mm
OR-544-05	28 cm (11"), 10.2 mm
OR-544-06	28 cm (11"), 11.4 mm
OR-544-07	28 cm (11"), 12.7 mm
OR-544-08	28 cm (11"), 14.0 mm
OR-544-09	28 cm (11"), 15.2 mm



**Modell USA Bone Curette**  
Oval

Catalog #	Size, Profile
OR-546-01	16 cm (6 1/4"), Fig. 1
OR-546-02	16 cm (6 1/4"), Fig. 2
OR-546-03	16 cm (6 1/4"), Fig. 3
OR-546-04	16 cm (6 1/4"), Fig. 4
OR-546-05	16 cm (6 1/4"), Fig. 5
OR-546-06	16 cm (6 1/4"), Fig. 6





Bone Curettes  
Scharfe Löffel  
Cucharillas cortantes  
Curettes tranchantes  
Curette taglienti

**Modell USA Bone Curette**  
Oval, Left



Catalog #	Size, Profile
OR-547-01	15.5 cm (6"), Fig. 1
OR-547-02	15.5 cm (6"), Fig. 2
OR-547-03	15.5 cm (6"), Fig. 3
OR-547-04	15.5 cm (6"), Fig. 4
OR-547-05	15.5 cm (6"), Fig. 5
OR-547-06	15.5 cm (6"), Fig. 6

**Modell USA Bone Curette**  
Oval, Right



Catalog #	Size, Profile
OR-548-01	15.5 cm (6"), Fig. 1
OR-548-02	15.5 cm (6"), Fig. 2
OR-548-03	15.5 cm (6"), Fig. 3
OR-548-04	15.5 cm (6"), Fig. 4
OR-548-05	15.5 cm (6"), Fig. 5
OR-548-06	15.5 cm (6"), Fig. 6

**Halle Bone Curette**  
Oval



Catalog #	Size, Scoop Size, Profile
OR-549-01	21 cm (8 1/4"), 4.4 mm, Fig. 000
OR-549-02	21 cm (8 1/4"), 5.2 mm, Fig. 00
OR-549-03	21 cm (8 1/4"), 6.8 mm, Fig. 0

**Daubenspeck Bone Curette**  
Oval



Catalog #	Size, Scoop Size, Profile
OR-550-40	20 cm (8"), 2.8 mm, Fig 0000
OR-550-30	20 cm (8"), 3.6 mm, Fig 000
OR-550-20	20 cm (8"), 4.4 mm, Fig 00
OR-550-10	20 cm (8"), 5.2 mm, Fig 0



Bone Curettes  
Scharfe Löffel  
Cucharillas cortantes  
Curettes tranchantes  
Curette taglianti

**Volkman Bone Curette**  
Double Ended, Oval/Oval

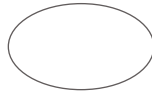

Catalog #	Size
OR-552-13	12.5 cm (5")
OR-552-14	14.5 cm (5 3/4")
OR-552-17	17 cm (6 3/4")

**Volkman Bone Curette**  
Double Ended, Round/Oval



Catalog #	Size
OR-554-13	13 cm (5")
OR-554-16	16 cm (6 1/4")
OR-554-20	20 cm (8")

**Bone Curette**  
Double Ended, Round/Oval

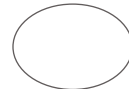

Catalog #	Size
OR-556-21	21 cm (8 1/4")

**Williger Bone Curette**  
Double Ended, Oval/Oval



Catalog #	Size, Profile
OR-558-00	13.5 cm (5 1/4"), Fig. 00 / Fig. 0
OR-558-01	13.5 cm (5 1/4"), Fig. 0 / Fig. 1
OR-558-12	13.5 cm (5 1/4"), Fig. 1 / Fig. 2



Bone Curettes  
Scharfe Löffel  
Cucharillas cortantes  
Curettes tranchantes  
Curette taglienti

**Williger Bone Curette**  
Double Ended, Oval/Oval

Catalog #	Size, Profile
OR-559-00	17 cm (6 3/4"), Fig. 00 / Fig. 0
OR-559-10	17 cm (6 3/4"), Fig. 0 / Fig. 1
OR-559-11	17 cm (6 3/4"), Fig. 1 / Fig. 2



**Bone Curette**

Catalog #	Size
OR-561-16	16 cm (6 1/4")



**Jansen Bone Curette**

Catalog #	Size
OR-563-16	16 cm (6 1/4")



**Hemingway Bone Curette**

Catalog #	Size
OR-565-16	17 cm (6 3/4")



**Hemingway Bone Curette**

Catalog #	Size
OR-567-17	17 cm (6 3/4")





Bone Curettes  
Scharfe Löffel  
Cucharillas cortantes  
Curettes tranchantes  
Curette taglianti

**Hemingway Bone Curette**

Catalog #	Size, Profile
OR-569-00	17 cm (6 3/4"), Fig. 0
OR-569-01	17 cm (6 3/4"), Fig. 1
OR-569-02	17 cm (6 3/4"), Fig. 2
OR-569-03	17 cm (6 3/4"), Fig. 3
OR-569-04	17 cm (6 3/4"), Fig. 4



**Lucas Bone Curette**

Catalog #	Size
OR-571-18	18 cm (7")



**Lucas Bone Curette**

Catalog #	Size
OR-573-18	18.5 cm (7 1/4")



**Kerpel Bone Curette**

Oval, Left

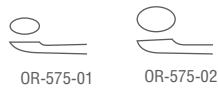

Catalog #	Size
OR-575-01	14.5 cm (5 3/4")
OR-575-02	14.5 cm (5 3/4")



**Kerpel Bone Curette**

Oval, Right

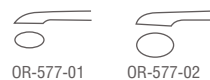

Catalog #	Size
OR-577-01	14.5 cm (5 3/4")
OR-577-02	14.5 cm (5 3/4")





Bone Currettes, Periosteal Elevators  
Scharfe Löffel, Raspatorien  
Cucharillas cortantes, Periostótomos  
Currettes tranchantes, Rugines-raspatoires  
Curette taglianti, Periostotomi

**Molt Bone Curette**

Catalog #	Size, Profile
OR-580-01	17 cm (6 3/4"), Fig. 1
OR-580-02	17 cm (6 3/4"), Fig. 2
OR-580-03	17 cm (6 3/4"), Fig. 3
OR-580-04	17 cm (6 3/4"), Fig. 4
OR-580-05	17.5 cm (7"), Fig. 5
OR-580-06	17.5 cm (7"), Fig. 6



**Molt Bone Curette  
Round Handle**

Catalog #	Size
OR-582-24	19 cm (7 1/2")



**Partsch Periosteal Raspatory / Elevator**

Catalog #	Size, Width
OR-591-32	15 cm (6"), 3.2 mm
OR-591-46	15 cm (6"), 3.2 mm



**Partsch Mod. Lange Periosteal Raspatory / Elevator**

Catalog #	Size, Width
OR-593-15	14.5 cm (5 3/4"), 4.0 mm

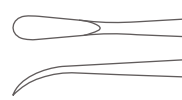

**Koenig Periosteal Raspatory / Elevator**

Catalog #	Size
OR-595-15	15.5 cm (6")

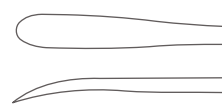



Periosteal Elevators  
Raspatorien  
Periostótomos  
Rugines-raspatoires  
Periostotomi

OR

BONE SURGERY

**Trelat Periosteal Raspatory / Elevator**

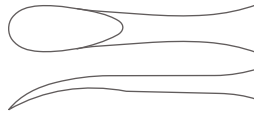

Catalog #	Size
OR-597-15	15.5 cm (6")

**Ward Periosteal Raspatory / Elevator**

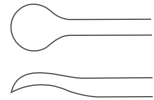

Catalog #	Size
OR-599-17	17 cm (6 3/4")

**Sewall Periosteal Raspatory / Elevator**



Catalog #	Size
OR-601-20	20 cm (8")

**Mead Periosteal Raspatory / Elevator**



Catalog #	Size
OR-602-16	16.5 cm (6 1/2")

**Molt Periosteal Raspatory / Elevator**

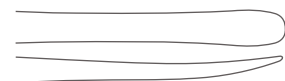

Catalog #	Size
OR-603-18	18 cm (7")



Periosteal Elevators  
Raspatorien  
Periostótomos  
Rugines-raspatoires  
Periostotomi

**Syme Periosteal Raspatory / Elevator**



Catalog #	Size, Width
OR-605-18	18.5 cm (7 1/4"), 4 mm

**Roberts Periosteal Raspatory / Elevator**

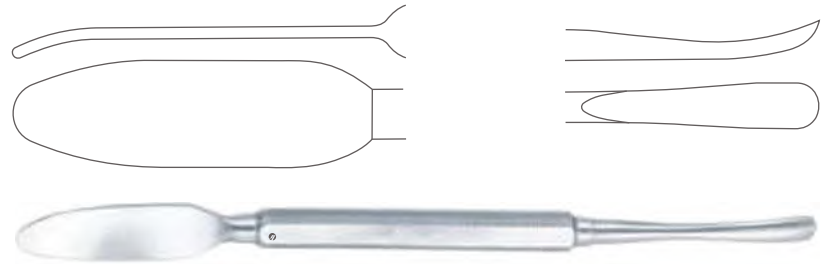

Catalog #	Size
OR-607-18	18.5 cm (7 1/4")

**Seldin Periosteal Raspatory / Elevator**



Catalog #	Size
OR-609-19	19.5 cm (7 3/4")

**Seldin Periosteal Raspatory / Elevator**



Catalog #	Size
OR-611-19	19.5 cm (7 3/4")

**Cottle Periosteal Raspatory / Elevator**

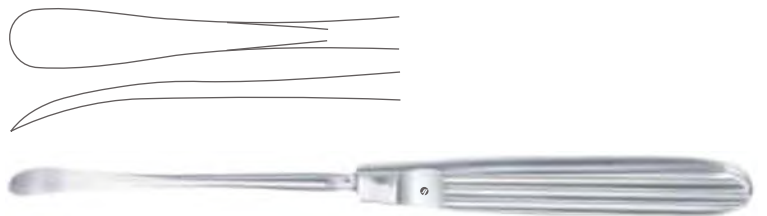

Catalog #	Size, Width
OR-613-19	19.5 cm (7 3/4"), 8 mm





Periosteal Elevators  
Raspatorien  
Periostótomos  
Rugines-raspatoires  
Periostotomi

OR

BONE SURGERY

**Landolt Periosteal Raspatory / Elevator**

Catalog #	Size
OR-615-17	17.5 cm (7")

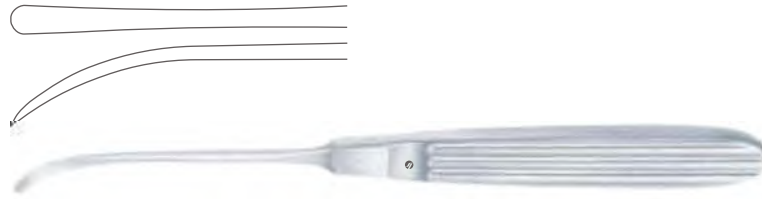

**Caspar Periosteal Raspatory / Elevator**

Catalog #	Size
OR-617-18	18 cm (7")



**Sedillot Periosteal Raspatory / Elevator**

Catalog #	Size, Width
OR-619-18	18.5 cm (7 1/4"), 18 mm

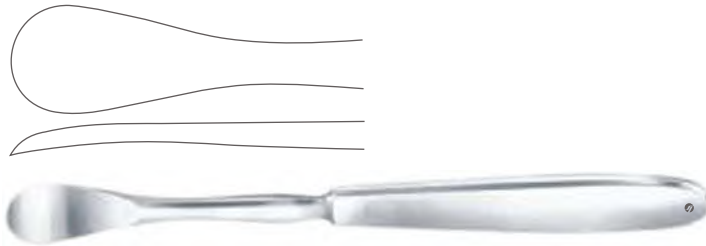

**McKissock Periosteal Raspatory / Elevator**

Catalog #	Size, Width
OR-620-19	19.5 cm (7 3/4"), 11 mm



**Kraemer Periosteal Raspatory / Elevator**

Catalog #	Size, Width
OR-621-18	18.5 cm (7 1/4"), 10 mm

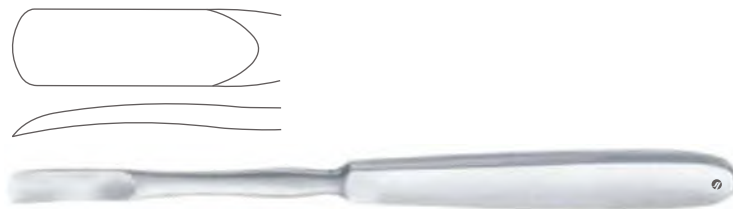



Periosteal Elevators  
Raspatorien  
Periostótomos  
Rugines-raspatoires  
Periostotomi

**Kraemer Periosteal Raspatory / Elevator**

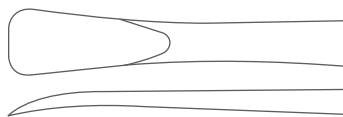

Catalog #	Size, Width
OR-623-19	19 cm (7 1/2"), 10 mm



**Pennybaker Periosteal Raspatory / Elevator**  
Blunt

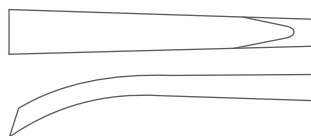

Catalog #	Size, Width
OR-625-16	16.5 cm (6 1/2"), 6 mm



**Buchs Periosteal Raspatory / Elevator**

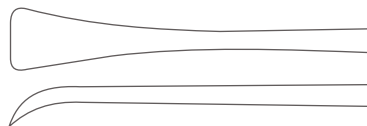

Catalog #	Size, Width
OR-627-19	19 cm (7 1/2"), 9.5 mm



**Jansen Periosteal Raspatory / Elevator**

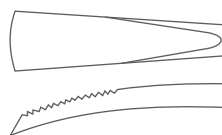

Catalog #	Size, Width
OR-629-16	16.5 cm (6 1/2"), 15 mm



**Key Periosteal Raspatory / Elevator**



Catalog #	Size, Width
OR-631-06	18 cm (7"), 6 mm
OR-631-10	19 cm (7 1/2"), 10 mm
OR-631-13	19 cm (7 1/2"), 13 mm
OR-631-19	20 cm (8"), 19 mm
OR-631-25	21 cm (8 1/4"), 25 mm





**Langenbeck Periosteal Raspatory / Elevator**

Catalog #	Size, Width
OR-635-01	19 cm (7 1/2"), 16 mm
OR-635-02	19 cm (7 1/2"), 16 mm
OR-635-03	18.5 cm (7 1/4"), 12 mm
OR-635-04	18 cm (7"), 12 mm

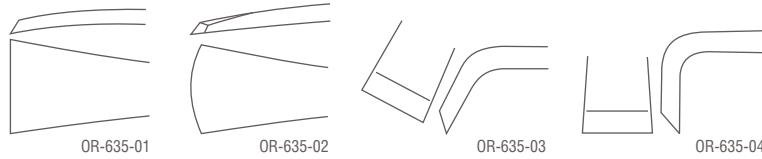

**Hoehn Periosteal Raspatory / Elevator**

Catalog #	Size, Width
OR-637-01	16 cm (6 1/4"), 7 mm
OR-637-02	18.5 cm (7 1/4"), 15 mm
OR-637-03	19 cm (7 1/2"), 20 mm

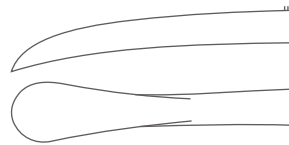

**Cushing Periosteal Raspatory / Elevator**

Catalog #	Size, Width
OR-639-01	17 cm (7"), 4 mm
OR-639-02	17.5 cm (7"), 5 mm
OR-639-03	19.5 cm (7 3/4"), 6 mm
OR-639-04	19.5 cm (7 3/4"), 7 mm

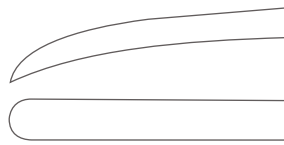

**Martin-Cushing Periosteal Raspatory / Elevator**

Catalog #	Size, Width
OR-640-17	17 cm (6 3/4"), 8 mm

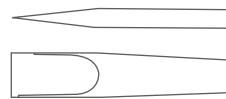



Periosteal Elevators  
Raspatorien  
Periostótomos  
Rugines-raspatoires  
Periostotomi

**Langenbeck Periosteal Raspatory / Elevator**

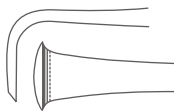

Catalog #	Size, Width
OR-641-18	18 cm (7"), 14 mm

**Langenbeck Periosteal Raspatory / Elevator**



Catalog #	Size, Width
OR-643-19	19.5 cm (7 3/4"), 16 mm

**Langenbeck Periosteal Raspatory / Elevator**



Catalog #	Size, Width
OR-645-05	16 cm (6 1/4"), 5 mm
OR-645-06	16.5 cm (6 1/4"), 6 mm
OR-645-07	16.5 cm (6 1/4"), 7 mm

**Farabeuf Periosteal Raspatory / Elevator**



Catalog #	Size
OR-648-15	15 cm (6")

**Farabeuf Periosteal Raspatory / Elevator**



Catalog #	Size
OR-649-15	15 cm (6")



Periosteal Elevators  
Raspatorien  
Periostótomos  
Rugines-raspatoires  
Periostotomi

OR

BONE SURGERY

**Sedillot Periosteal Raspatory / Elevator**



Catalog #	Size
OR-651-21	22 cm (8 3/4")

**FiberGrip™ Periosteal Raspatory / Elevator**

**FIBERGrip™**



Catalog #	Size, Width
OR-654-19	19 cm (7 1/2"), 6mm

**FiberGrip™ Periosteal Raspatory / Elevator**

**FIBERGrip™**



Catalog #	Size, Width
OR-655-20	20 cm (8"), 14 mm

**FiberGrip™ Periosteal Raspatory / Elevator**

**FIBERGrip™**



Catalog #	Size, Width
OR-657-20	19 cm (7 1/2"), 14 mm

**FiberGrip™ Periosteal Raspatory / Elevator**

**FIBERGrip™**



Catalog #	Size, Width
OR-659-18	18 cm (7"), 6 mm



Periosteal Elevators  
Raspatorien  
Periostótomos  
Rugines-raspatoires  
Periostotomi

**FiberGrip™ Periosteal Raspatory / Elevator**

**FIBERGrip™**

Catalog #	Size, Width
OR-661-18	18 cm (7"), 6 mm

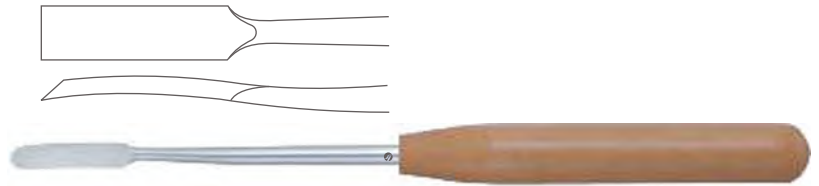

**FiberGrip™ Periosteal Raspatory / Elevator**

**FIBERGrip™**

Catalog #	Size, Width
OR-663-18	18 cm (7"), 3 mm

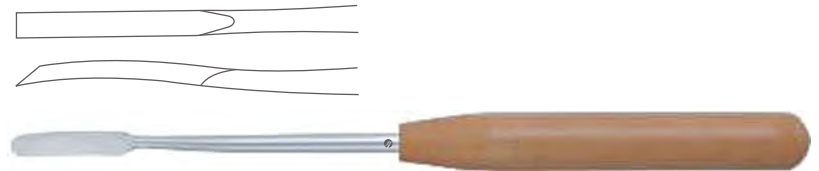

**FiberGrip™ Periosteal Raspatory / Elevator**

**FIBERGrip™**

Catalog #	Size, Width
OR-665-17	18.5 cm (7"), 13 mm



**FiberGrip™ Periosteal Raspatory / Elevator**

**FIBERGrip™**

Catalog #	Size, Width
OR-666-20	20 cm (8"), 19 mm



**FiberGrip™ Periosteal Raspatory / Elevator**

**FIBERGrip™**

Catalog #	Size, Width
OR-667-18	18 cm (7"), 13 mm





**FiberGrip™ Periosteal Raspatory / Elevator**

**FIBERGrip™**



Catalog #	Size, Width
OR-669-27	27.5 cm (10 3/4"), 20 mm

**FiberGrip™ Wagner Periosteal Raspatory / Elevator**

**FIBERGrip™**

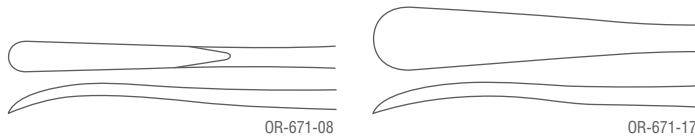

Catalog #	Size, Width
OR-671-08	33 cm (13"), 8 mm
OR-671-17	33 cm (13"), 17 mm

**Williger Periosteal Raspatory / Elevator**



Catalog #	Size, Width
OR-673-13	12.5 cm (5"), 5 mm

**Kahre-Williger Periosteal Raspatory / Elevator**



Catalog #	Size, Width
OR-675-01	16 cm (6 1/4"), 4 mm
OR-675-02	16 cm (6 1/4"), 5 mm

**Williger Periosteal Raspatory / Elevator**



Catalog #	Size, Width
OR-677-01	16 cm (6 1/4"), 7 mm
OR-677-02	16 cm (6 1/4"), 5 mm



Periosteal Elevators  
Raspatorien  
Periostótomos  
Rugines-raspatoires  
Periostotomi

**Periosteal Raspatory / Elevator**

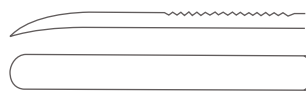

Catalog #	Size, Width
OR-679-06	17 cm (6 3/4"), 8 mm
OR-679-08	17 cm (6 3/4"), 6 mm



**Doyen Rib Raspatory**

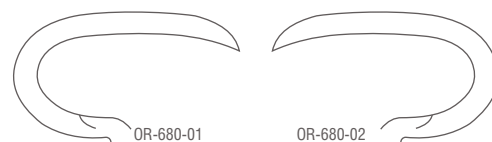

Catalog #	Size, Profile
OR-680-01	17.5 cm (7"), Curved Right
OR-680-02	17.5 cm (7"), Curved Left



**Doyen Rib Raspatory  
For Children**



Catalog #	Size, Profile
OR-681-01	17.5 cm (7"), Curved Right
OR-681-02	17.5 cm (7"), Curved Left



**Alexander Periosteal Raspatory / Elevator**



Catalog #	Size
OR-682-21	21 cm (8 1/4")





**Semb Periosteal Raspatory / Elevator**

Catalog #	Size, Width, Profile
OR-683-01	18.5 cm (7 1/4"), 12 mm, Fig. 1
OR-683-02	18.5 cm (7 1/4"), 12 mm, Fig. 2
OR-683-03	18.5 cm (7 1/4"), 13 mm, Fig. 3
OR-683-04	18.5 cm (7 1/4"), 13 mm, Fig. 4
OR-683-05	18.5 cm (7 1/4"), 15 mm, Fig. 5

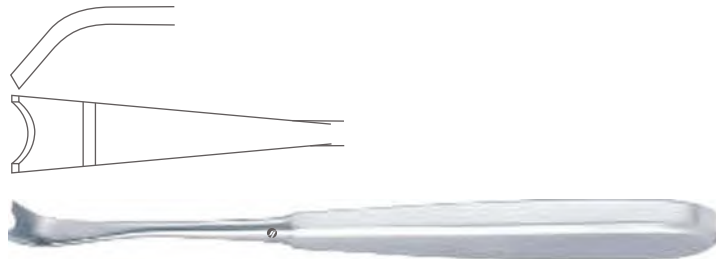

**Lambotte Periosteal Raspatory / Elevator**

Catalog #	Size, Width
OR-684-10	21.5 cm (8 1/2"), 10 mm
OR-684-15	21.5 cm (8 1/2"), 15 mm
OR-684-20	21.5 cm (8 1/2"), 20 mm
OR-684-25	21.5 cm (8 1/2"), 25 mm



**Adson Periosteal Raspatory / Elevator**

Catalog #	Size
OR-685-01	17 cm (6 3/4")
OR-685-02	17 cm (6 3/4")
OR-685-03	17.5 cm (7")
OR-685-04	17 cm (6 3/4")

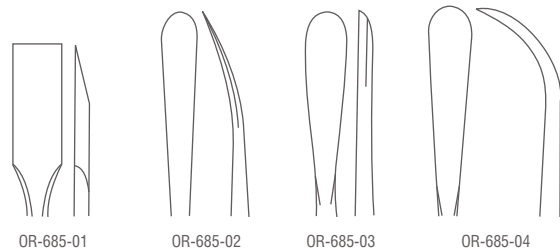

**Cobb Periosteal Raspatory / Elevator**

Catalog #	Size, Width
OR-687-10	28 cm (11"), 10 mm
OR-687-13	28 cm (11"), 13 mm
OR-687-19	28 cm (11"), 19 mm
OR-687-26	28 cm (11"), 26 mm
OR-687-32	28 cm (11"), 32 mm

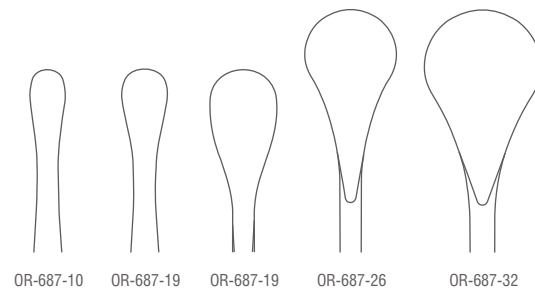



Periosteal Elevators  
Raspatorien  
Periostótomos  
Rugines-raspatoires  
Periostotomi

**Langenbeck Periosteal Elevator**



Catalog #	Size, Blade Width
OR-691-20	19.5 cm (7 3/4"), 8 mm

**Langenbeck Periosteal Elevator**

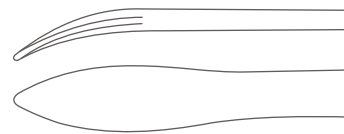

Catalog #	Size, Blade Width
OR-693-20	19.5 cm (7 3/4"), 10 mm

**Martin-Langenbeck Periosteal Elevator**

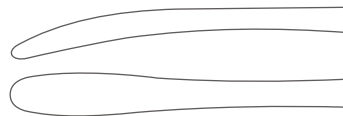

Catalog #	Size, Blade Width
OR-695-01	17 cm (6 3/4"), 5 mm
OR-695-02	17 cm (6 3/4"), 7 mm
OR-695-03	17 cm (6 3/4"), 8 mm
OR-695-04	19.5 cm (7 3/4"), 10 mm

**Williger Periosteal Elevator**

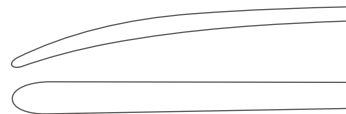

Catalog #	Size, Blade Width
OR-697-04	16 cm (6 1/4"), 4 mm
OR-697-07	17 cm (6 3/4"), 7 mm

**Micro Elevator**



Catalog #	Size
OR-699-16	16 cm (6 1/4")



Periosteal Elevators  
Raspatorien  
Periostótomos  
Rugines-raspatoires  
Periostotomi

OR

BONE SURGERY

**Phalangeal Elevator**

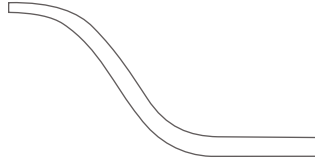

Catalog #	Size
OR-701-16	16 cm (6 1/4")



**Alderdyce Periosteal Elevator**  
Double Ended



Catalog #	Size
OR-703-21	21 cm (8 1/4")



**McDonald Periosteal Elevator**  
Double Ended

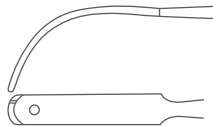

Catalog #	Size
OR-705-19	18.5 cm (7 1/4")



**Watson-Cheyne Periosteal Elevator**



OR-707-13



OR-707-13



OR-707-19



OR-707-19

Catalog #	Size
OR-707-13	13 cm (5 1/4")
OR-707-19	19 cm (7 1/2")



**Swedish Periosteal Elevator**



Catalog #	Size
OR-709-18	18 cm (7")
OR-709-20	20 cm (8")





Periosteal Elevators  
Raspatorien  
Periostótomos  
Rugines-raspatoires  
Periostotomi

**Pennybaker Periosteal Elevator**



Catalog #	Size
OR-711-23	23 cm (9")

**O'Connell Periosteal Elevator**



Catalog #	Size
OR-713-22	22 cm (9")

**Toennis Periosteal Elevator**



Catalog #	Size
OR-715-24	24 cm (9 1/2")

**Bone Lever**



Catalog #	Size
OR-721-06	16 cm (6 1/4")

**Mini-Hohmann Bone Lever**

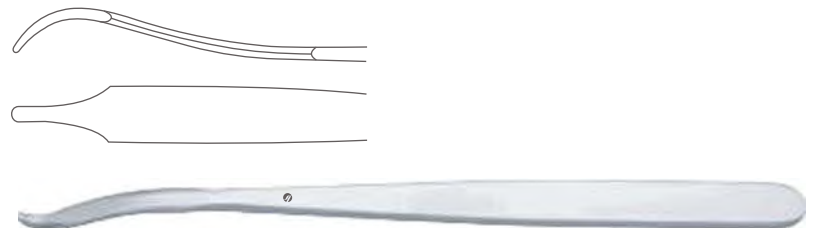

Catalog #	Size, Blade Width
OR-723-06	16 cm (6 1/4"), 6 mm
OR-723-08	16 cm (6 1/4"), 8 mm



Bone Levers  
Knochenhebel  
Elevadores para hueso  
Leviers à os  
Elevatori per ossa

OR

BONE SURGERY

**Bone Lever**

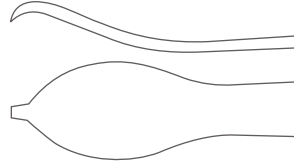

Catalog #      Size, Blade Width  
OR-725-15      16 cm (6 1/4"), 15 mm



**Bone Lever**

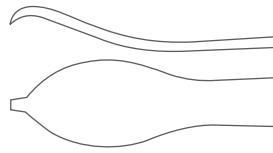

Catalog #      Size, Blade Width  
OR-727-16      12 cm (4 3/4"), 15 mm



**Wagner Bone Lever**

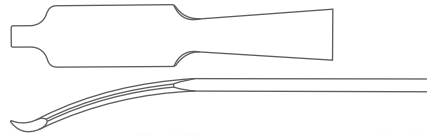

Catalog #      Size  
OR-729-22      22 cm (8 3/4")



**Bone Lever**

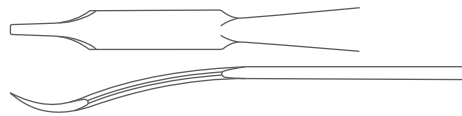

Catalog #      Size  
OR-731-22      22 cm (8 3/4")



**Hohmann Bone Lever  
Narrow Tip**



Catalog #      Size, Blade Width  
OR-733-08      22 cm (8 3/4"), 8 mm





Bone Levers  
Knochenhebel  
Elevadores para hueso  
Leviers à os  
Elevatori per ossa

**Hohmann Bone Lever**  
Narrow Tip



Catalog #	Size, Blade Width
OR-733-18	23.5 cm (9 1/2"), 18 mm

**Hohmann Bone Lever**  
Narrow Tip



Catalog #	Size, Blade Width
OR-733-43	23.5 cm (9 1/2"), 43 mm

**Hohmann Bone Lever**  
Narrow Tip



Catalog #	Size, Blade Width
OR-733-70	25 cm (9 3/4"), 70 mm

**Hohmann Bone Lever**  
Narrow Tip



Catalog #	Size, Blade Width
OR-735-43	23.5 cm (9 1/4"), 43 mm

**Hohmann Bone Lever**  
Wide Tip



Catalog #	Size, Blade Width
OR-737-22	25.5 cm (10"), 22 mm



Bone Levers  
Knochenhebel  
Elevadores para hueso  
Leviers à os  
Elevatori per ossa

**Hohmann Bone Lever**  
Wide Tip



Catalog #	Size, Blade Width
OR-737-35	29 cm (11 1/2"), 35 mm

**Hohmann Bone Lever**  
Wide Round Tip



Catalog #	Size, Blade Width
OR-739-24	27.5 cm (10 3/4"), 24 mm

**Lange-Hohmann Bone Lever**  
Wide Tip With groove



Catalog #	Size, Blade Width
OR-741-22	25.5 cm (9 3/4"), 22 mm

**Lange-Hohmann Modif Bone Lever**

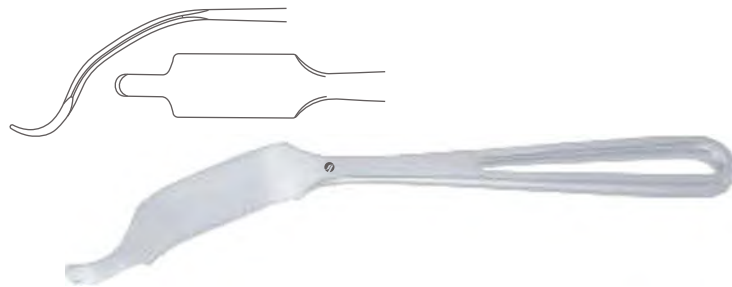

Catalog #	Size, Blade Width
OR-743-30	26.5 cm (10 1/2"), 30 mm

**Lange-Hohmann Modif Bone Lever**

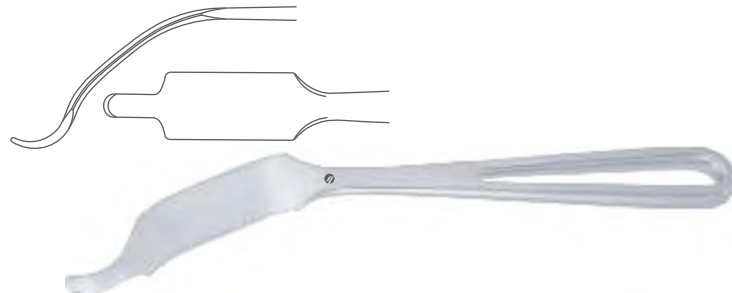

Catalog #	Size, Blade Width
OR-743-33	29 cm (11 1/2"), 33 mm



Bone Levers  
Knochenhebel  
Elevadores para hueso  
Leviers à os  
Elevatori per ossa

**Verbrugge-Mueller Bone Lever**



Catalog #	Size, Blade Width
OR-745-44	24 cm (9 1/2"), 44 mm

**Verbrugge-Mueller Bone Lever**



Catalog #	Size, Blade Width
OR-745-65	25.5 cm (10"), 65 mm

**Bone Lever**

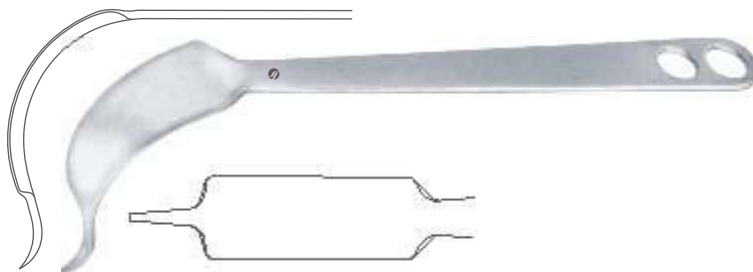

Catalog #	Size, Blade Width
OR-749-40	29 cm (11 1/2"), 40 mm

**Bone Lever**



Catalog #	Size, Blade Width
OR-751-22	30 cm (12"), 22 mm

**Hohmann-Aldinger Bone Lever**



Catalog #	Size, Blade Width
OR-753-24	27 cm (10 3/4"), 24 mm





Bone Levers  
Knochenhebel  
Elevadores para hueso  
Leviers à os  
Elevatori per ossa

OR

BONE SURGERY

**Schumacher (Wagner) Bone Lever**  
Toothed Edge



Catalog #	Size, Blade Size
OR-755-37	34.5 cm (13 1/2"), 37 mm, 18 mm

**Schumacher Bone Lever**

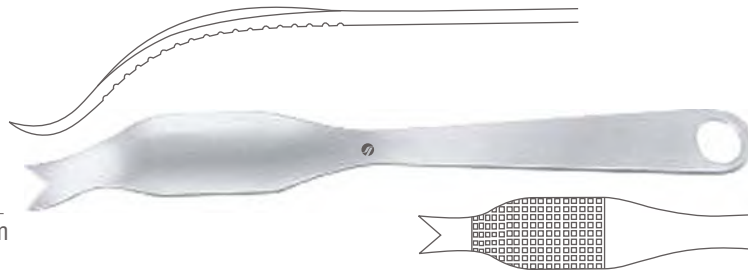

Catalog #	Size, Blade Size
OR-757-35	29 cm (11 1/2"), 35 mm, 18 mm

**Watson-Jones Bone Lever**



Catalog #	Size
OR-759-28	28 cm (11")

**Bennett Bone Lever**



Catalog #	Size, Blade Width
OR-761-43	24 cm (9 1/2"), 43 mm
OR-761-60	23.5 cm (9 1/4"), 60 mm

**Murphy-Lane Bone Lever**



Catalog #	Size, Blade Width
OR-763-30	32 cm (12 1/2"), 30 mm



Bone Levers, Knee Retractors, Spinal Retractors  
Knochenhebel, Kniehaken, Spinalhaken  
Elevadores para hueso, Separadores para rodilla, Separadores espinales  
Leviers à os, Ecarteurs pour le genou, Ecarteurs spinaux  
Elevatori per ossa, Divaricatori per il ginocchio, Divaricatori spinali

**Lane-Terthowan Bone Lever**



Catalog #	Size
OR-765-21	21.5 cm (8 1/2")

**Lane Bone Lever**

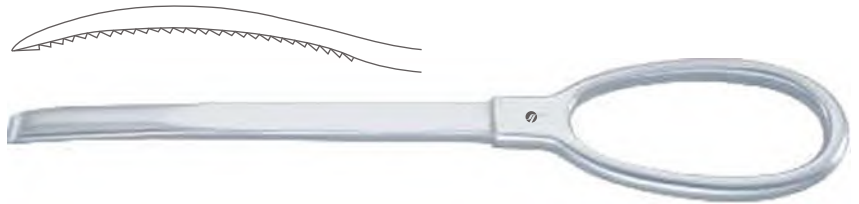

Catalog #	Size
OR-765-25	25.5 cm (10")

**Bristow Bone Lever**



Catalog #	Size
OR-765-23	23 cm (9")

**Chandler Bone Lever**

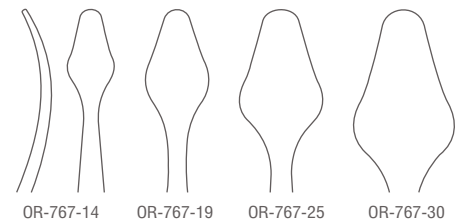

Catalog #	Size, Blade Width
OR-767-14	18 cm (7"), 14 mm
OR-767-19	20 cm (8"), 19 mm
OR-767-25	23 cm (9"), 25 mm
OR-767-30	25 cm (9 3/4"), 30 mm



**Smillie Knee Retractor**

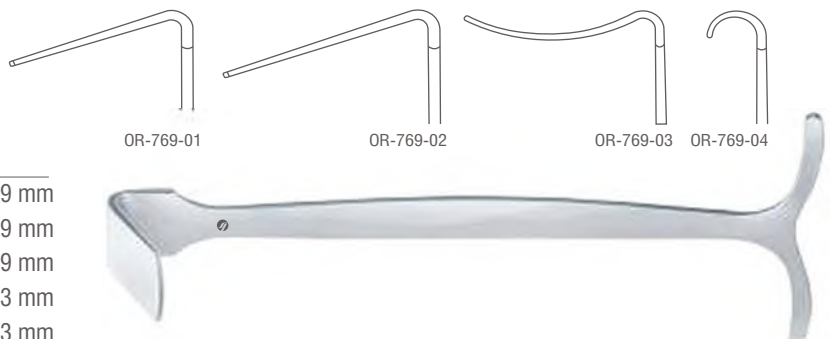

Catalog #	Size, Blade Size
OR-769-01	14 cm (5 1/2"), 32 x 19 mm
OR-769-02	14 cm (5 1/2"), 48 x 19 mm
OR-769-03	14 cm (5 1/2"), 57 x 19 mm
OR-769-04	14 cm (5 1/2"), 52 x 13 mm
OR-769-05	14 cm (5 1/2"), 12 x 13 mm



Knee Retractors, Spinal Retractors  
Kniehaken, Spinalhaken  
Separadores para rodilla, Separadores espinales  
Ecarteurs pour le genou, Ecarteurs spinaux  
Divaricatori per il ginocchio, Divaricatori spinali

**Blount Knee Retractor**  
Blunt



Catalog #	Size
OR-771-26	26.5 cm (10 1/2")

**Blount Knee Retractor**



Catalog #	Size
OR-773-26	26.5 cm (10 1/2")

**Blount Knee Retractor**



Catalog #	Size
OR-775-17	17.5 cm (7")

**Taylor Knee Retractor**



Catalog #	Size, Blade Size
OR-777-16	16 cm (6 1/4"), 75 x 30 mm

**Taylor Knee Retractor**



Catalog #	Size, Blade Size
OR-779-16	16cm (6 1/4"), 100 x 30 mm



Meniscus Knives  
Meniskotome, Meniskussmesser  
Cuchillos para menisco  
Bistouris à ménisque  
Meniscotomi

**Hibbs Knee Retractor**

Catalog #	Size, Blade Size
OR-781-13	23.5 cm (9 1/4"), 13 x 25 mm
OR-781-20	23.5 cm (9 1/4"), 20 x 50 mm
OR-781-25	23.5 cm (9 1/4"), 25 x 75 mm

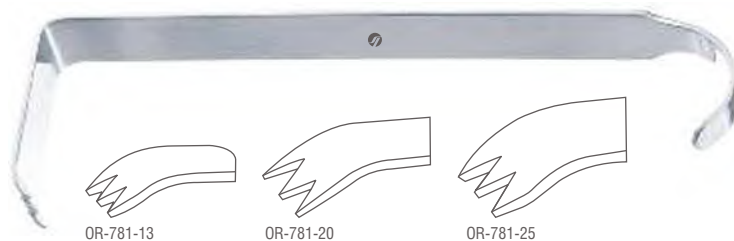

**Smillie Meniscus Knife**

Catalog #	Size
OR-790-17	17.5 cm (7")



**Smillie Meniscus Knife  
Left**

Catalog #	Size
OR-791-17	17.5 cm (7")



**Smillie Meniscus Knife  
Right**

Catalog #	Size
OR-793-17	17.5 cm (7")



**Meniscus Knife**

Catalog #	Size
OR-795-18	18 cm (7")





Meniscus Knives, Tendon Strippers  
Meniskotome, Meniskusmesser, Sehnenstripper  
Cuchillos para menisco, Enucleadores de tendones  
Bistouris à ménisque, Instruments à écorcher les tendons  
Meniscotomi, Scollatendini

**Neff Meniscus Knife**  
Fig. 1



Catalog #	Size
OR-797-22	22 cm (8 3/4")

**Neff Meniscus Knife**  
Fig. 2



Catalog #	Size
OR-799-22	22 cm (8 3/4")

**Selenius Meniscus Knife**  
Fig. 1



Catalog #	Size
OR-801-22	21 cm (8 1/4")

**Selenius Meniscus Knife**  
Fig. 2



Catalog #	Size
OR-803-22	21 cm (8 1/4")

**Bunnell Tendon Stripper**

Catalog #	Size, Profile
OR-810-01	15 cm (6"), Fig. 1
OR-810-02	15 cm (6"), Fig. 2
OR-810-03	15 cm (6"), Fig. 3
OR-810-04	15 cm (6"), Fig. 4
OR-810-05	15 cm (6"), Fig. 5





Tendon Strippers  
Sehnenstripper  
Enucleadores de tendones  
Instruments à écorcher les tendons  
Scollatendini

**Tendon Stripper**  
Flexible Shaft



Catalog #	Size, Diameter
OR-812-40	23 cm (9"), 4.0 mm
OR-812-45	23 cm (9"), 4.5 mm
OR-812-55	23 cm (9"), 5.5 mm

**Tendon Passing Instruments**



Catalog #	Size
OR-814-00	33.5 cm (13 1/4")

**Screw Only for Tendon Passing Instruments**



Catalog #	Size
OR-814-90	31 cm (12 1/4")

**Fischer Tendon Stripper**  
Blunt



Catalog #	Size
OR-816-31	28.5 cm (11 1/4")

**Tendon Stripper**



Catalog #	Size
OR-818-29	23 cm (9")



Tendon Holding Forceps, Tendon Tunnelling Forceps  
Sehnenfasszangen, Sehnedurchzugzangen  
Pinzas para coger tendones, Pinzas para pasar tendones  
Pincas pour saisir les tendons, Pincas pour passer les tendons  
Pinze per afferrare tendini, Pinze passa-tendini

**Bunnell Tendon Passer**  
Malleable



Catalog #	Size
OR-820-23	16 cm (6 1/4")

**Steinmann Tendon Holding Forcep**



Catalog #	Size
OR-824-16	15 cm (6")

**Brand Tendon Tunnelling Forcep**  
1 x 2 Teeth



Catalog #	Size
OR-827-15	19 cm (7 1/2")
OR-827-19	24 cm (9 3/4")
OR-827-24	21 cm (8 1/4")

**Tendon Tunnelling Forcep**  
1 x 2 Teeth



Catalog #	Size
OR-828-21	21 cm (8 1/4")

**Tendon Tunnelling Forcep**  
1 x 2 Teeth



Catalog #	Size
OR-829-21	21 cm (8 1/4")



Tendon Holding Forceps, Tendon Interlacing Forceps  
 Sehnenfasszangen, Sehneneinflechtklemmen  
 Pinzas para coger tendones, Pinzas para entrelazar tendones  
 Pincas pour saisir les tendons, Pincas pour entrelacer les tendons  
 Pinze per afferrare tendini, Pinze per allacciare tendini

**Carroll Tendon Tunnelling Forcep**



Catalog #	Size
OR-831-11	11.5 cm (4 1/2")

**Tendon Holding Forcep**



Catalog #	Size
OR-832-13	11.5 cm (4 1/2")

**Kleinert-Kutz Tendon Holding Forcep**

1 x 2 Teeth



Catalog #	Size
OR-834-20	21 cm (8 1/4")

**Tendon Interlacing Forcep**

Pointed



Catalog #	Size
OR-836-15	15.5 cm (6")

**Tendon Interlacing Forcep**

Pointed

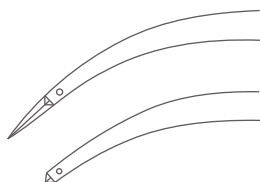

Catalog #	Size
OR-837-15	15 cm (6")





Reposition Forceps  
Repositionszangen  
Pinzas para reposición  
Pinces à réduction  
Pinze per riposizioni

**Bone Repositioning Forcep**  
Long Ratchet, Pointed

Catalog #	Size
OR-851-09	9 cm (3 1/2")
OR-851-14	15 cm (6")



**Steinhauser Bone Repositioning Forcep**

Catalog #	Size
OR-853-13	13 cm (5")



**Reill Bone Repositioning Forcep**

Catalog #	Size
OR-855-17	17 cm (6 3/4")

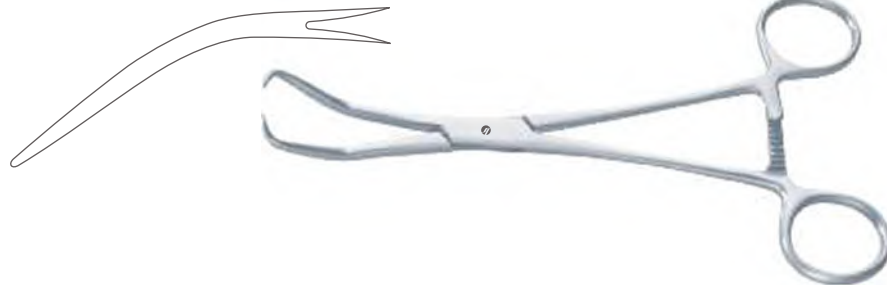

**Bone Repositioning Forcep**

Catalog #	Size
OR-857-20	20.5 cm (8")

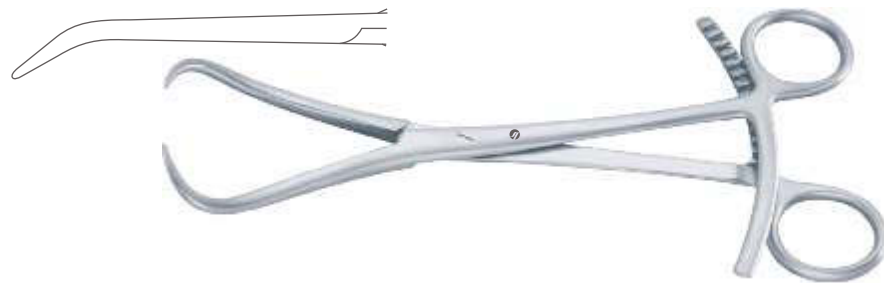

**Bone Repositioning Forcep**  
Long Ratchet, Pointed

Catalog #	Size
OR-859-12	13.5 cm (5 1/4")





Reposition Forceps, Bone Holding Forceps  
Repositionszangen, Knochenhalte-zangen  
Pinzas para reposición, Pinzas para hueso  
Pinces à réduction, Daviers porte-os  
Pinze per riposizioni, Tenaglie per ossa

**Lewin Bone Repositioning Forcep**



Catalog #	Size
OR-862-17	18.5 cm (7 1/4")

**Bone Repositioning Forcep  
Delicate**



Catalog #	Size
OR-864-14	14 cm (5 1/2")

**Bone Repositioning Forcep / Patella Forceps  
Self, Centering**



Catalog #	Size
OR-866-18	18.5 cm (7 1/2")

**Bone Repositioning Forcep / Malleolar Forceps**



Catalog #	Size
OR-868-21	21 cm (8 1/4")

**Bone Holding Forcep**



Catalog #	Size
OR-869-14	14 cm (5 1/2")



Reposition Forceps, Bone Holding Forceps  
Repositionszangen, Knochenhalte-zangen  
Pinzas para reposición, Pinzas para hueso  
Pinces à réduction, Daviers porte-os  
Pinze per riposizioni, Tenaglie per ossa

**Bone Repositioning Forcep**  
With Tread Fixation

Catalog #	Size
OR-871-16	17 cm (6 3/4")
OR-871-24	24 cm (9 1/2")



**Langenbeck Bone Holding Forcep**

Catalog #	Size
OR-874-21	21 cm (8 1/4")



**Fergusson Bone Holding Forcep**  
Heavy Pattern

Catalog #	Size
OR-876-21	21 cm (8 1/4")



**Bone Holding Forcep**  
Heavy Pattern

Catalog #	Size
OR-878-20	20 cm (8")



**Bone Holding Forcep / Sequestrum Forcep**

Catalog #	Size, Profile
OR-880-20	20 cm (8"), Straight
OR-881-20	20 cm (8"), Curved





Reposition Forceps, Bone Holding Forceps  
Repositionszangen, Knochenhaltezangen  
Pinzas para reposición, Pinzas para hueso  
Pinces à réduction, Daviers porte-os  
Pinze per riposizioni, Tenaglie per ossa

**Bircher-Ganske Cartilage Seizing Forcep**

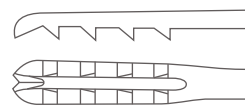

Catalog #	Size, Profile
OR-882-01	20.5 cm (8"), Straight
OR-882-02	20.5 cm (8"), Curved Upwards
OR-882-03	20 cm (8"), Curved Sideways

**Salyer Bone Holding Forcep**  
Curved Sideways

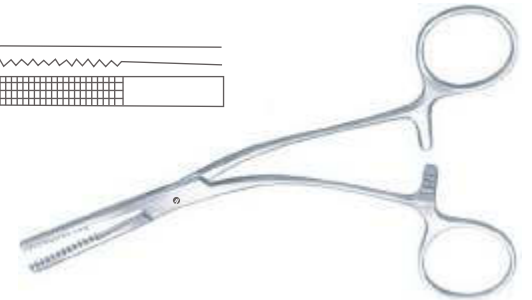
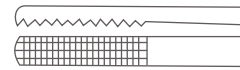

Catalog #	Size
OR-885-16	16 cm (6 1/4")

**Van Buren Bone Holding Forcep**



Catalog #	Size
OR-887-01	23 cm (9")

**Semb Bone Holding Forcep**

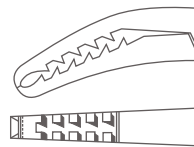

Catalog #	Size
OR-887-02	19 cm (7 1/2")

**Dingmann Cartilage Seizing Forcep**

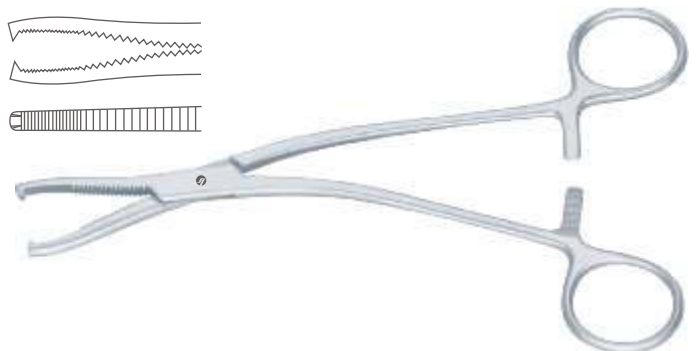
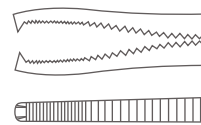

Catalog #	Size
OR-889-19	18.5 cm (7 1/4")



Bone Holding Forceps  
Knochenhaltezaugen  
Pinzas para hueso  
Daviers porte-os  
Tenaglie per ossa

OR

BONE SURGERY

**Martin Cartilage Seizing Forcep**



Catalog #	Size
OR-892-19	18.5 cm (7 1/4")

**Frosch Bone Holding Forcep**

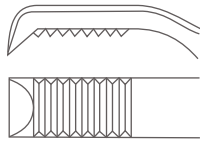

Catalog #	Size
OR-894-18	18 cm (7")

**Kern Bone Holding Forcep**

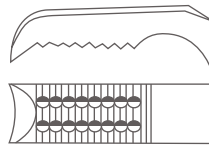
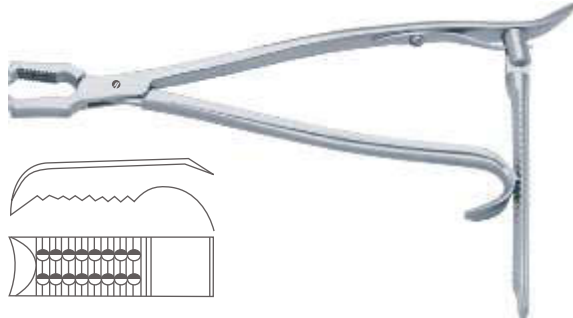

Catalog #	Size
OR-896-17	17 cm (6 3/4")
OR-896-21	21 cm (8 1/4")

**Heygroves Bone Holding Forcep**  
With Thread Fixations



Catalog #	Size
OR-899-21	21 cm (8 1/4")
OR-899-27	27 cm (10 3/4")
OR-899-30	30 cm (12")

**Semb Bone Holding Forcep**  
Curved Sideways, With Ratchet

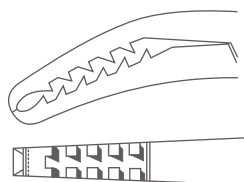

Catalog #	Size
OR-901-19	19 cm (7 1/2")



Bone Holding Forceps  
Knochenhaltezaugen  
Pinzas para hueso  
Daviers porte-os  
Tenaglie per ossa

**Farabeuf Bone Holding Forcep**



Catalog #	Size
OR-904-23	23 cm (9")
OR-904-26	26 cm (10 1/4")

**Farabeuf Bone Holding Forcep  
With Ratchet**



Catalog #	Size
OR-906-26	26 cm (10 1/4")

**Lambotte Bone Holding Forcep  
Straight**



Catalog #	Size
OR-908-22	22 cm (8 3/4")

**Lambotte Bone Holding Forcep  
Straight, One Jaw Moveable**



Catalog #	Size
OR-908-26	26 cm (10 1/4")
OR-908-33	33 cm (13")

**Ulrich Bone Holding Forcep  
Straight, With Thread Fixation**

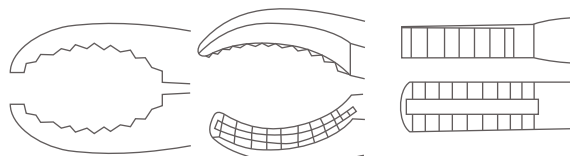

Catalog #	Size
OR-910-23	23 cm (9")
OR-910-25	25 cm (9 3/4")
OR-910-28	28 cm (11")







Bone Holding Forceps  
Knochenhaltezangen  
Pinzas para hueso  
Daviers porte-os  
Tenaglie per ossa

**Ulrich Bone Holding Forcep**  
Curved, With Thread Fixation

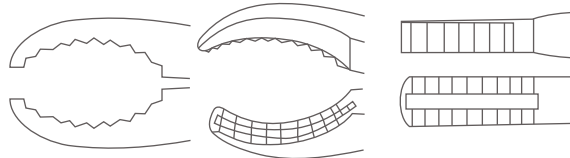

Catalog #	Size
OR-911-23	22 cm (8 3/4")
OR-911-25	24 cm (9 1/2")
OR-911-28	27 cm (10 3/4")



**Bone Holding Forcep**  
Self Centering, With Thread Fixation

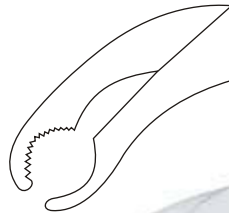

Catalog #	Size
OR-913-15	15 cm (6")
OR-913-19	19 cm (7 1/2")
OR-913-24	24 cm (9 1/2")
OR-913-26	26 cm (10 1/4")
OR-913-28	28 cm (11")



**Lane Bone Holding Forcep**  
Without Ratchet

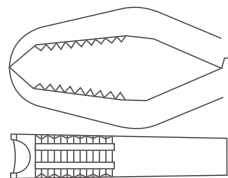

Catalog #	Size
OR-916-33	33 cm (13")



**Lane Bone Holding Forcep**  
With Ratchet

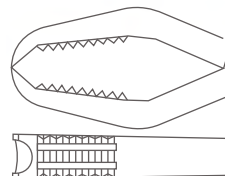

Catalog #	Size
OR-918-33	33 cm (13")

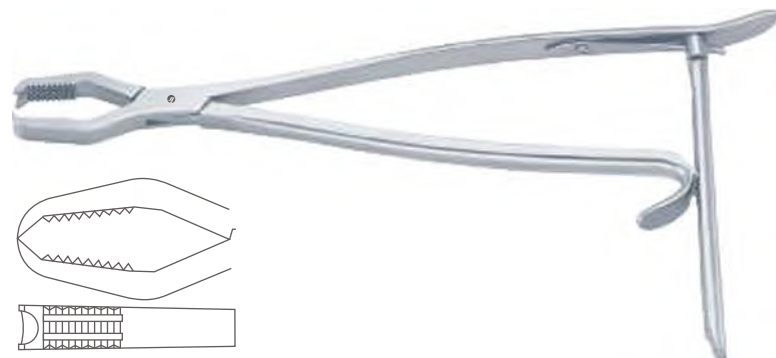



Bone Holding Forceps, Bone Rongeurs  
Knochenhaltezaugen, Hohlmeißelzaugen  
Pinzas para hueso, Pinzas gubias  
Daviers porte-os, Pincen-gouges  
Tenaglie per ossa, Pinze-sgorbie

**Verbrugge Bone Holding Forcep**

Catalog #	Size
OR-921-01	25 cm (9 3/4")
OR-921-02	26 cm (10 1/4")
OR-921-03	27 cm (10 3/4")



**Verbrugge Bone Holding Forcep**

Catalog #	Size
OR-923-01	17.5 cm (7")



**Percy Amputation Shield**  
Detachable

Catalog #	Size
OR-925-00	Standard



**Stellbrink Bone Rongeur**

Catalog #	Size
OR-931-01	17.5 cm (7")
OR-931-02	16.5 cm (6 1/2")



**Friedman Bone Rongeur**

Catalog #	Size
OR-932-12	12.5 cm (5")







Bone Rongeurs  
Hohlmeißelzangen  
Pinzas gubias  
Pinces-gouges  
Pinze-sgorbie

OR

BONE SURGERY

**Friedman Bone Rongeur**

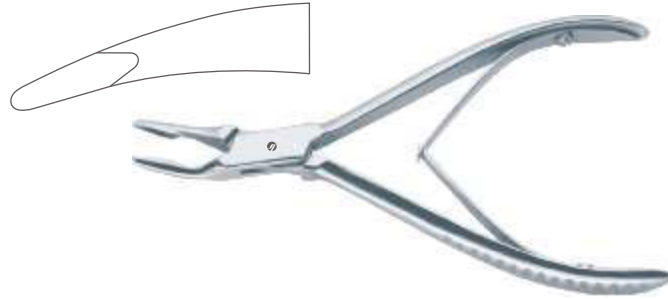

Catalog #      Size  
OR-933-01      13.5 cm (5 1/4")

**Friedman Bone Rongeur**

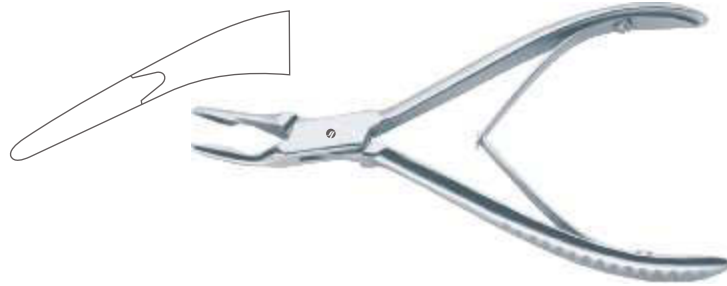

Catalog #      Size  
OR-934-02      13.5 cm (5 1/4")

**Cleveland Bone Rongeur**



Catalog #      Size  
OR-935-01      13.5 cm (5 1/4")

**Cleveland Bone Rongeur**



Catalog #      Size  
OR-935-02      16.5 cm (6 1/2")

**Mead Bone Rongeur**

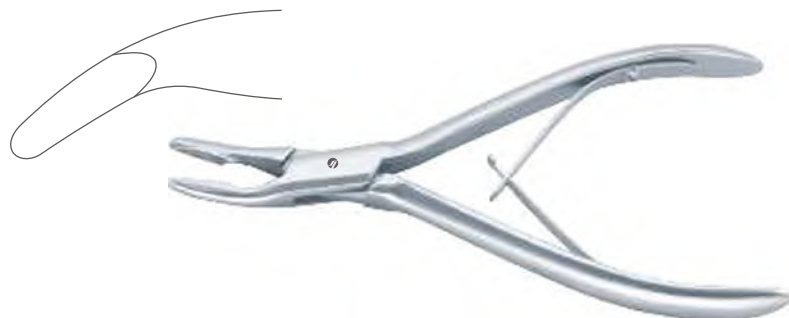

Catalog #      Size  
OR-937-16      16.5 cm (6 1/2")



Bone Rongeurs  
Hohlmeißelzangen  
Pinzas gubias  
Pincas-gouges  
Pinze-sgorbie

**Hartmann Bone Rongeur**



Catalog #	Size
OR-937-18	17.5 cm (7")

**Jansen Bone Rongeur  
Straight**



Catalog #	Size
OR-938-18	18 cm (7")

**Jansen Bone Rongeur  
Curved**



Catalog #	Size
OR-939-18	18 cm (7")

**Lempert Bone Rongeur**



Catalog #	Size
OR-940-19	19 cm (7 1/2")

**Blumenthal Bone Rongeur**



Catalog #	Size
OR-941-01	15 cm (6")



Bone Rongeurs  
Hohlmeißelzangen  
Pinzas gubias  
Pinces-gouges  
Pinze-sgorbie

**Blumenthal Bone Rongeur**

Catalog #	Size
OR-941-02	15 cm (6")



**Blumenthal Bone Rongeur**

Catalog #	Size
OR-941-03	14 cm (5 1/2")



**Luer Bone Rongeur  
Straight**

Catalog #	Size
OR-942-18	18.5 cm (7 1/4")



**Luer Bone Rongeur  
Curved**

Catalog #	Size
OR-943-18	18 cm (7")



**Luer Bone Rongeur**

Catalog #	Size
OR-945-01	14.5 cm (5 3/4")
OR-945-02	14.5 cm (5 3/4")
OR-945-03	14.5 cm (5 3/4")





Bone Rongeurs  
Hohlmeißelzangen  
Pinzas gubias  
Pincés-gouges  
Pinze-sgorbie

**Bohler Bone Rongeur**  
Straight, Compound Action



Catalog #	Size
OR-946-15	15.5 cm (6")

**Bohler Bone Rongeur**  
Curved, Compound Action



Catalog #	Size
OR-947-15	15.5 cm (6")

**Beyer Bone Rongeur**  
Compound Action



Catalog #	Size
OR-949-18	18 cm (7")

**Zaufal-Jansen Bone Rongeur**  
Compound Action



Catalog #	Size
OR-951-18	18 cm (7")

**Mayfield Bone Rongeur**  
Compound Action



Catalog #	Size
OR-953-17	18 cm (7")



Bone Rongeurs  
Hohlmeißelzangen  
Pinzas gubias  
Pinces-gouges  
Pinze-sgorbie

OR

BONE SURGERY

**Marquard Bone Rongeur**  
Compound Action

Catalog #      Size  
OR-953-20      20.5 cm (8")



**Ruskin Bone Rongeur**  
Compound Action

Catalog #      Size  
OR-955-18      19 cm (7 1/2")



**Ruskin Bone Rongeur**  
Compound Action

Catalog #      Size  
OR-955-24      24 cm (9 1/2")



**Semb Bone Rongeur**  
Compound Action

Catalog #      Size  
OR-957-22      23.5 cm (9 1/4")



**Stille Bone Rongeur**  
Compound Action

Catalog #      Size  
OR-957-23      22.5 cm (8 3/4")





Bone Rongeurs  
Hohlmeißelzangen  
Pinzas gubias  
Pinces-gouges  
Pinze-sgorbie

**Echlin Bone Rongeur**  
Compound Action

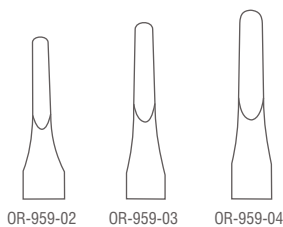

Catalog #	Size, Bite Size
OR-959-02	23 cm (9"), 2 x 10 mm
OR-959-03	23 cm (9"), 3 x 10 mm
OR-959-04	23 cm (9"), 4 x 10 mm

**Stille-Ruskin Bone Rongeur**  
Compound Action



Catalog #	Size
OR-959-23	23.5 cm (9 1/4")

**Roettgen-Ruskin Bone Rongeur**  
Compound Action



Catalog #	Size
OR-959-24	24.5 cm (9 3/4")

**Leksell-Stille Bone Rongeur**  
Compound Action



Catalog #	Size
OR-961-01	24.5 cm (9 3/4")

**Leksell-Stille Bone Rongeur**  
Compound Action



Catalog #	Size
OR-961-02	24.5 cm (9 3/4")

INCHES  
MILLIMETERS





Bone Rongeurs  
Hohlmeißelzangen  
Pinzas gubias  
Pincas-gouges  
Pinze-sgorbie

**Frykholm Bone Rongeur**  
Compound Action



Catalog #	Size
OR-963-24	24.5 cm (9 3/4")

**Stille-Luer Bone Rongeur**  
Straight, Compound Action



Catalog #	Size
OR-964-22	22.5 cm (8 3/4")

**Stille-Luer Bone Rongeur**  
Curved, Compound Action



Catalog #	Size
OR-965-22	22.5 cm (8 3/4")

**Stille-Luer Bone Rongeur**  
Straight, Compound Action



Catalog #	Size
OR-966-23	23 cm (9")
OR-966-27	26.5 cm (10 1/2")

**Stille-Luer Bone Rongeur**  
Curved, Compound Action



Catalog #	Size
OR-967-23	23 cm (9")
OR-967-27	26.5 cm (10 1/2")



Bone Rongeurs, Bone Cutting Forceps  
Hohlmeißelzangen, Knochensplitterzangen  
Pinzas gubias, Pinzas cortantes para hueso  
Pincers-gouges, Pincers coupantes à os  
Pinze-sgorbie, Cesioie per ossa

**Sauerbruch Bone Rongeur**  
Compound Action

Catalog #	Size
OR-968-01	31 cm (12 1/4")
OR-968-02	31 cm (12 1/4")

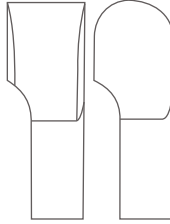

**Cottle-Kazanjian Bone Cutting Forcep**

Catalog #	Size
OR-970-19	18.5 cm (7 1/4")

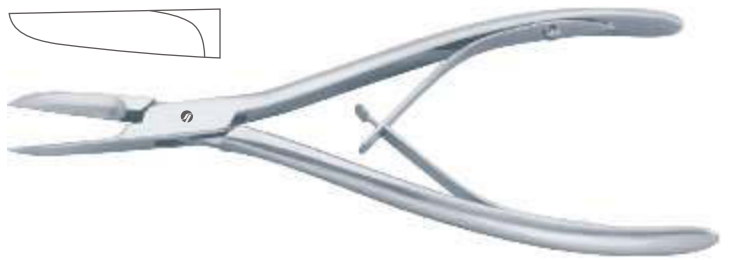

**Liston Bone Cutting Forcep**  
Straight

Catalog #	Size
OR-972-14	14 cm (5 1/2")
OR-972-17	17 cm (6 3/4")
OR-972-19	20 cm (8")
OR-972-22	22 cm (8 3/4")

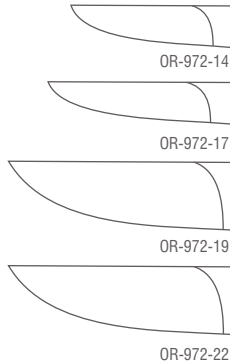

**Liston Bone Cutting Forcep**  
Curved

Catalog #	Size
OR-973-14	14 cm (5 1/2")
OR-973-17	17 cm (6 3/4")
OR-973-19	20 cm (8")
OR-973-22	22 cm (8 3/4")

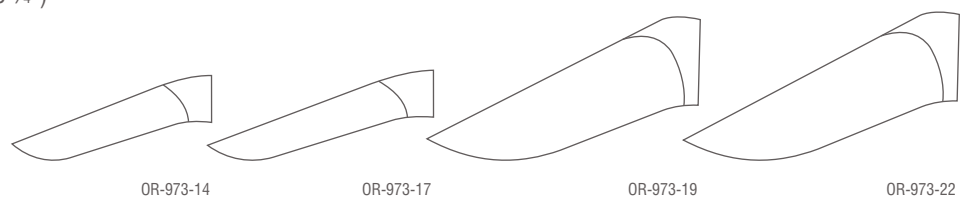

OR-973-14      OR-973-17      OR-973-19      OR-973-22





Bone Cutting Forceps  
Knochensplitterzangen  
Pinzas cortantes para hueso  
Pinces coupantes à os  
Cesoie per ossa

**Cleveland Bone Cutting Forcep**

Catalog #	Size
OR-975-15	14.5 cm (5 3/4")
OR-975-17	17 cm (6 3/4")



**Bohler Bone Cutting Forcep**  
Compound Action, Light

Catalog #	Size
OR-976-15	14.5 cm (5 3/4")



**Bohler Bone Cutting Forcep**  
Compound Action, Heavy

Catalog #	Size
OR-977-15	14.5 cm (5 3/4")



**Cleveland Bone Cutting Forcep**

Catalog #	Size
OR-979-15	16 cm (6 1/4")



**Ruskin-Liston Bone Cutting Forcep**  
Straight, Compound Action

Catalog #	Size
OR-980-18	18 cm (7")





Bone Cutting Forceps  
Knochensplitterzangen  
Pinzas cortantes para hueso  
Pincès coupantes à os  
Cesoie per ossa

**Ruskin-Liston Bone Cutting Forcep**  
Curved, Compound Action



Catalog #	Size
OR-981-18	18 cm (7")

**Stille-Liston Bone Cutting Forcep**

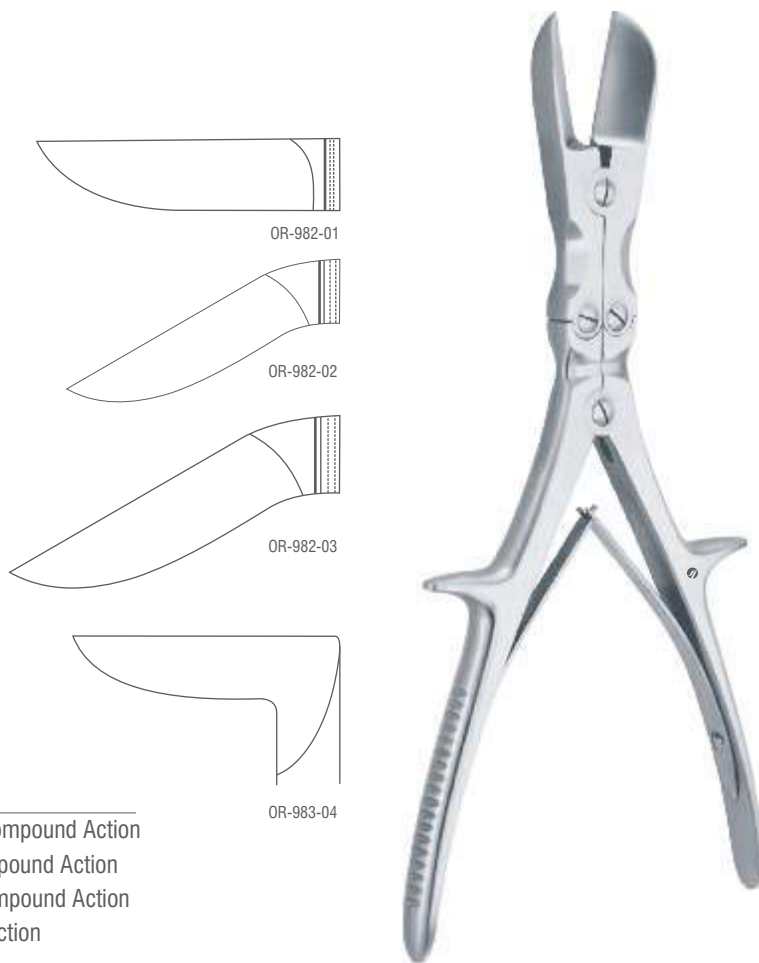

Catalog #	Size, Profile
OR-982-01	27.5 cm (10 3/4"), Straight, Compound Action
OR-982-02	23.5 cm (9 1/4"), Curved Compound Action
OR-982-03	27.5 cm (10 3/4"), Curved Compound Action
OR-983-04	26 cm (10 1/4"), Compound Action

**Liston-Key Bone Cutting Forcep**  
Compound Action



Catalog #	Size
OR-985-27	25.5 cm (10")



Hand Restrainer, Tourniquet  
Handhalter, Kompressorium  
Sujetador de mano, Compresor  
Reteneur pour main, Compresseur  
Fissatore per mano, compressorio

**Semb Bone Cutting Forcep**  
Compound Action



Catalog #	Size
OR-987-25	24.5 cm (9 3/4")

**Hand Immobilizer**  
Aluminium



Catalog #	Profile
OR-988-01	For Children
OR-988-02	For Adults

**Feldheim Tourniquet**



Catalog #	Size
OR-990-10	10 cm (4")

**Ideal Finger Nail Drill Complete**  
With Drill Ref: OR-992-01 to OR-992-03



Catalog #	Size
OR-992-00	Standard

**Spare Drill**



Catalog #	Profile
OR-992-01	Small
OR-992-02	Medium
OR-992-03	Large



Finger Ring Saws, Finger Nail Drill  
Fingerringsägen, Fingernagelbohrer  
Sierras para abrir anillos, Dedo clavo perforación  
Scies pour couper les bagues, Foret d'angle de doigt  
Seghe per anelli, Dito trivello del chiodo

### Martin Finger Ring Saw



Catalog #	Size
OR-994-17	18.5 cm (7 1/4")

### Spare Saw Blade



Catalog #	Size
OR-994-90	Standard

### Walton Finger Ring Saw



Catalog #	Size
OR-995-16	16 cm (6 1/4")

### Spare Saw Blade



Catalog #	Size
OR-995-01	Standard

### Finger Ring Saw



Catalog #	Size
OR-996-17	17 cm (6 3/4")



Nail Extracting Forceps  
Nagelextraktionszangen  
Pinzas para arrancar uñas  
Pincas pour extraire les ongles  
Pinze per la lacerazione delle unghie

**Spare Saw Blade**

Catalog #	Size
OR-996-10	N/A



**Anvil Nail Extracting Forcep**

Catalog #	Size
OR-998-12	12.5 cm (5")

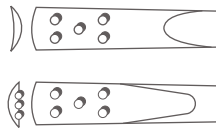

**Radolf Nail Extracting Forcep**

Catalog #	Size
OR-999-13	14 cm (5 1/2")

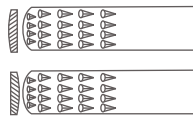





**SURTEX**  
INSTRUMENTS

*Crafted to Excellence*

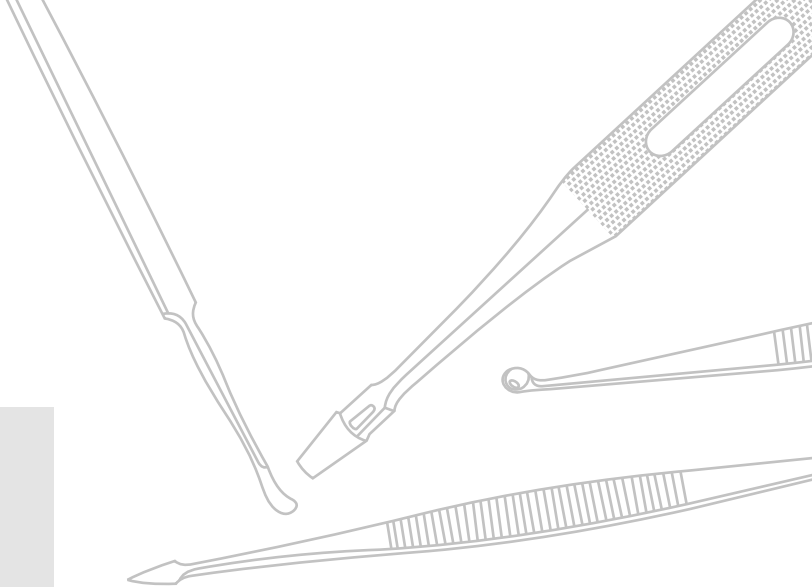

DM



## DERMATOLOGY

A dermatology practice requires an instrument provider that is fast, reliable and manufactures products of premium quality. This is precisely why dermatologists recommend our dermatology instruments to their colleagues without hesitation. At Surtex Instruments we specialize in scissors, curettes and punches most often used by dermatologists.

Dermatologie

Dermatología

Dermatologie

Dermatologia



Milium Knife, Lupus Instruments  
 Milienmesser, Lupusinstrumente  
 Chuchillo para milium, Instrumentos para lupus  
 Couteau pour milium, Instruments pour les lupus  
 Bisturi per milie, Strumenti per lupus

**Monocorps Milium Knife**



Catalog #	Size
DM-100-14	14 cm (5 1/2")

**Vidal Lupus Scraper**



Catalog #	Size
DM-111-14	13 cm (5")

**Fox Lupus Curette**



Catalog #	Size, Profile
DM-200-01	14 cm (5 1/2"), Fig. 1
DM-200-02	14 cm (5 1/2"), Fig. 2
DM-200-03	14 cm (5 1/2"), Fig. 3
DM-200-04	14 cm (5 1/2"), Fig. 4



**Wolff Lupus Curette**



Catalog #	Size, Profile
DM-220-01	14 cm (5 1/2"), Fig. 1
DM-220-02	14 cm (5 1/2"), Fig. 2
DM-220-03	14 cm (5 1/2"), Fig. 3
DM-220-04	14 cm (5 1/2"), Fig. 4
DM-220-05	14 cm (5 1/2"), Fig. 5
DM-220-06	14 cm (5 1/2"), Fig. 6

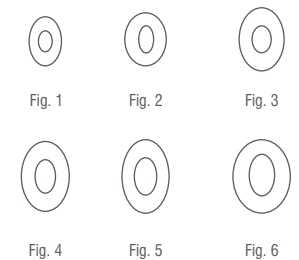





Dermal Punches  
Hauttrephine  
Trépanos para piel  
Trépanos cutanés  
Trefine cutanee

**Kaye Face-Lift Hook**



Catalog #	Size, Profile
DM-225-04	13 cm (5"), 4 Prongs
DM-225-05	13 cm (5"), 5 Prongs

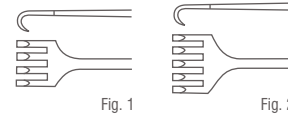

**Dermal Punch**  
Sharp



Catalog #	Size, Diameter
DM-300-00	8 cm (3 1/4"), Handle Only
DM-300-02	5.5 cm (2 1/4"), 2.0 mm Ø
DM-300-04	5.5 cm (2 1/4"), 4.0 mm Ø
DM-300-06	5.5 cm (2 1/4"), 6.0 mm Ø
DM-300-08	5.5 cm (2 1/4"), 8.0 mm Ø
DM-300-10	5.5 cm (2 1/4"), 10.0 mm Ø
DM-300-12	5.5 cm (2 1/4"), 12.0 mm Ø

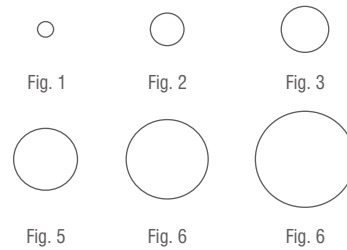

**Keyes Dermal Punch**  
Sharp



Catalog #	Size, Diameter
DM-320-02	11 cm (4 1/2"), 2.0 mm Ø
DM-320-03	11 cm (4 1/2"), 3.0 mm Ø
DM-320-04	11 cm (4 1/2"), 4.0 mm Ø
DM-320-05	11 cm (4 1/2"), 5.0 mm Ø
DM-320-06	11 cm (4 1/2"), 6.0 mm Ø
DM-320-07	11 cm (4 1/2"), 7.0 mm Ø
DM-320-08	11 cm (4 1/2"), 8.0 mm Ø

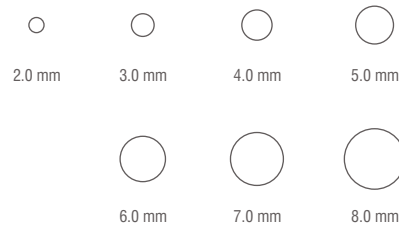

**Unna Comedone Extractor**



Catalog #	Size
DM-351-14	14.5 cm (5 3/4")





Comedone Extractors  
Komedoneninstrumente  
Extractores para comedones  
Tire-comédons  
Tiracomedoni

**Unna Comedone Extractor**



Catalog #	Size
DM-353-14	14.5 cm (5 3/4")

**Saalfeld Comedone Extractor**



Catalog #	Size
DM-361-10	11 cm (4 1/2")

**Saalfeld Comedone Extractor**



Catalog #	Size
DM-365-14	14.5 cm (5 3/4")

**Schamberg Comedone Extractor**



Catalog #	Size
DM-371-10	9.5 cm (3 3/4")

**Katsch Comedone Extractor**



Catalog #	Size
DM-381-14	16 cm (6 1/4")



Comedone Extractors  
Komedoneninstrumente  
Extractores para comedones  
Tire-comédons  
Tiracomedoni

**Unna-Vidal Comedone Extractor**

Catalog #	Size
DM-390-11	11.5 cm (4 1/2")

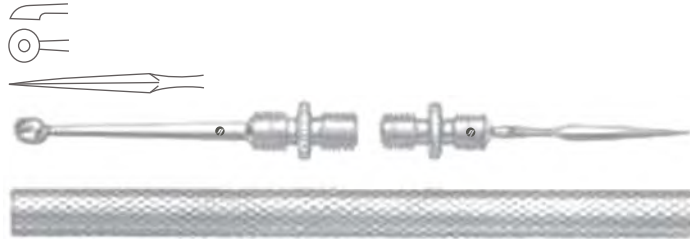





**SURTEX**  
INSTRUMENTS

*Crafted to Excellence*

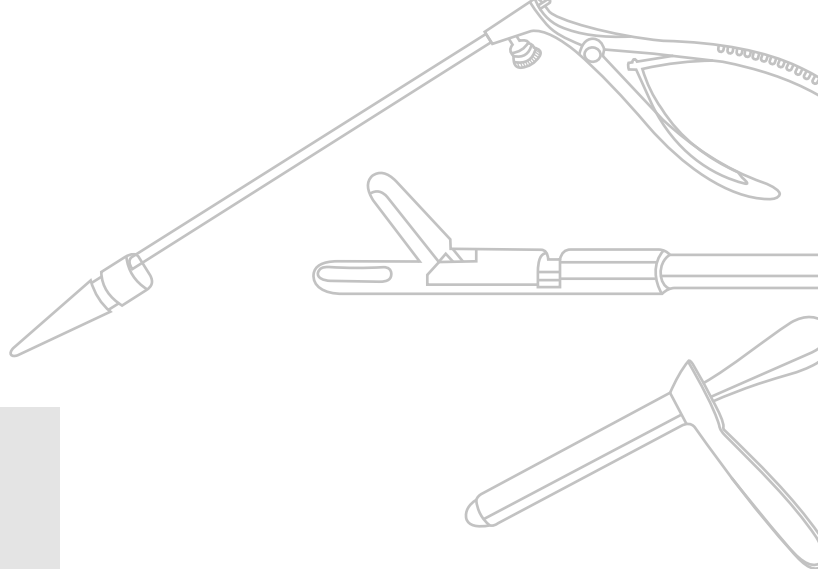

SI



## STOMACH, INTESTINES, RECTUM

Surtex manufactures a broad range of instruments for specialist field of stomach, intestine and rectum surgery. Our range includes but is not limited to the following intestinal and tissue grasping forceps, intestinal clamps, rectal specula, rectal spreaders, anoscope, proctoscopes, rectoscopes, hemorrhoidal ligator & rectal biopsy forceps.

Magen, Darm, Rektum

Estómago, Intestinos, Recto

Estomac, Intestins, Rectum

Stomaco, Intestini, Retto



Intestinal and Tissue Grasping Forceps  
Darm- und Gewebefasszangen  
Pinzas para intestinos y tejidos  
Pinces pour saisir intestins et tissus  
Pinze per afferrare intestino e tessuti

**Allis-Baby Intestinal and Tissue Grasping Forcep**  
4 x 5 Teeth

Catalog #	Size
SI-010-12	13 cm (5")



**Allis Intestinal and Tissue Grasping Forcep**  
4 x 5 Teeth

Catalog #	Size
SI-012-15	15.5 cm (6")



**Allis Intestinal and Tissue Grasping Forcep**  
5 x 6 Teeth

Catalog #	Size
SI-015-15	15.5 cm (6")
SI-015-19	19 cm (7 1/2")
SI-015-25	25.5 cm (10")



**Allis Atrauma Intestinal and Tissue Grasping Forcep**

Catalog #	Size
SI-020-16	15.5 cm (6")
SI-020-20	20 cm (8")
SI-020-25	24.5 cm (9 3/4")
SI-020-30	30 cm (11 3/4")



**Allis-Adair Intestinal and Tissue Grasping Forcep**  
10 x 11 Teeth

Catalog #	Size
SI-024-15	16 cm (6 1/4")





Intestinal and Tissue Grasping Forceps  
Darm- und Gewebefasszangen  
Pinzas para intestinos y tejidos  
Pinces pour saisir intestins et tissus  
Pinze per afferrare intestino e tessuti

**Boys-Allis Intestinal and Tissue Grasping Forcep**  
5 x 6 Teeth



Catalog #	Size
SI-026-15	15.5 cm (6")

**Judd-Allis Intestinal and Tissue Grasping Forcep**  
3 x 4 Teeth



Catalog #	Size
SI-028-15	15.5 cm (6")
SI-028-19	19 cm (7 1/2")

**Thomas-Allis Intestinal and Tissue Grasping Forcep**  
6 x 7 Teeth



Catalog #	Size
SI-030-20	20.5 cm (8")

**Allis Intestinal and Tissue Grasping Forcep**  
5 x 6 Teeth



Catalog #	Size
SI-032-20	20 cm (8")

**Lockwood Intestinal and Tissue Grasping Forcep**



Catalog #	Size
SI-040-20	20 cm (8")



Intestinal and Tissue Grasping Forceps  
Darm- und Gewebefasszangen  
Pinzas para intestinos y tejidos  
Pincas pour saisir intestins et tissus  
Pinze per afferrare intestino e tessuti

**Littlewood Intestinal and Tissue Grasping Forcep**



Catalog #	Size
SI-042-18	18.5 cm (7 1/4")

**Williams Intestinal and Tissue Grasping Forcep**

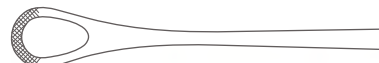

Catalog #	Size
SI-050-16	16.5 cm (6 1/2")

**UltaGrip™ TC Babcock Intestinal and Tissue Grasping Forcep**

**ULTRA Grip™**

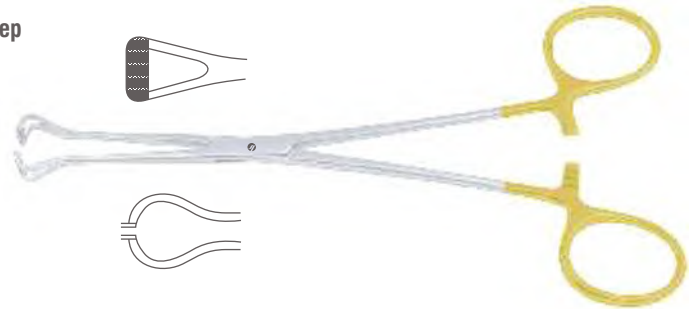
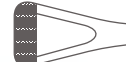

Catalog #	Size
SI-056-16	16.5 cm (6 1/2")
SI-056-20	21 cm (8 1/4")

**Babcock Intestinal and Tissue Grasping Forcep**



Catalog #	Size
SI-060-16	15.5 cm (6")
SI-060-18	17.5 cm (7")
SI-060-20	21 cm (8 1/4")
SI-060-24	24 cm (9 1/2")

**Babcock Atrauma Intestinal and Tissue Grasping Forcep**



Catalog #	Size
SI-062-16	16 cm (6 1/4")
SI-062-20	20.5 cm (8")





Intestinal and Tissue Grasping Forceps  
Darm- und Gewebefasszangen  
Pinzas para intestinos y tejidos  
Pinces pour saisir intestins et tissus  
Pinze per afferrare intestino e tessuti

**UltraGrip™ TC Duval Intestinal and Tissue Grasping Forcep**



Catalog #	Size
SI-070-20	20.5 cm (8")

**Duval Intestinal and Tissue Grasping Forcep  
Narrow Jaw**



Catalog #	Size
SI-072-18	18 cm (7")

**Duval Intestinal and Tissue Grasping Forcep  
Wide Jaw**



Catalog #	Size
SI-074-23	23 cm (9")

**Doyen-Baby Intestinal Clamp  
Straight**



Catalog #	Size
SI-100-18	18 cm (7")

**Doyen-Baby Intestinal Clamp  
Curved**



Catalog #	Size
SI-101-18	17.5 cm (7")



Intestinal Clamps  
Darmklemmen  
Pinzas intestinales  
Pinces intestinales  
Pinze intestinali

**Doyen Intestinal Clamp**  
Straight



Catalog #	Size
SI-102-23	23.5 cm (9 1/4")

**Doyen Intestinal Clamp**  
Curved



Catalog #	Size
SI-103-23	23 cm (9")

**Mayo-Robson Intestinal Clamp**  
Straight



Catalog #	Size
SI-110-21	21.5 cm (8 1/2")
SI-110-23	23.5 cm (9 1/4")
SI-110-25	25.5 cm (10")

**Mayo-Robson Intestinal Clamp**  
Curved



Catalog #	Size
SI-111-21	21.5 cm (8 1/2")
SI-111-23	23 cm (9")
SI-111-25	24.5 cm (9 3/4")

**Kocher-Baby Intestinal Clamp**  
Straight



Catalog #	Size
SI-120-13	13 cm (5")



Intestinal Clamps  
Darmklemmen  
Pinzas intestinales  
Pinces intestinales  
Pinze intestinali

**Kocher-Baby Intestinal Clamp**  
Curved



Catalog #	Size
SI-121-13	13 cm (5")

**Kocher Intestinal Clamp**  
Straight

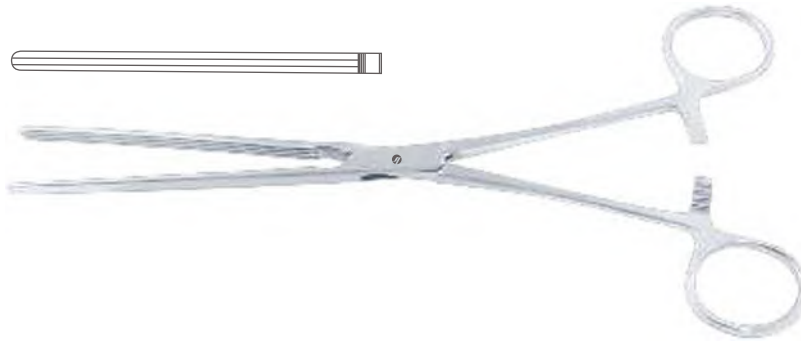

Catalog #	Size
SI-122-22	22.5 cm (8 3/4")
SI-122-25	25 cm (9 3/4")
SI-122-28	28.5 cm (11 1/4")

**Kocher Intestinal Clamp**  
Curved



Catalog #	Size
SI-123-22	22.5 cm (8 3/4")
SI-123-25	24.5 cm (9 3/4")
SI-123-28	27.5 cm (10 3/4")

**Allen Intestinal Clamp**



Catalog #	Size
SI-128-16	16 cm (6 1/4")

**Payr-Baby Intestinal Clamp**



Catalog #	Size
SI-131-15	15 cm (6")



Intestinal Clamps  
Darmklemmen  
Pinzas intestinales  
Pinces intestinales  
Pinze intestinali

**Payr Intestinal Clamp**



Catalog #	Size
SI-133-21	20.5 cm (8")
SI-133-29	29 cm (11 1/2")
SI-133-35	34.5 cm (13 1/2")

**Nussbaum Intestinal Clamp**  
Straight

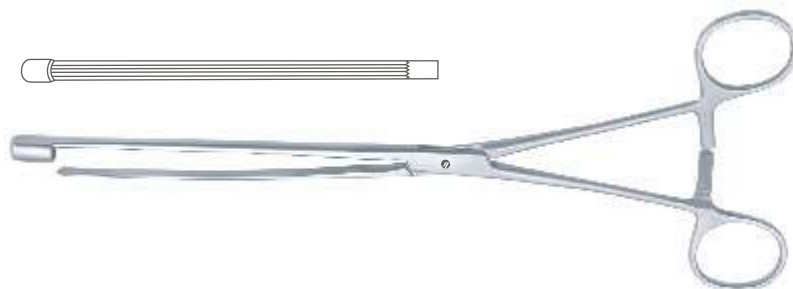

Catalog #	Size
SI-138-25	25 cm (9 3/4")

**Nussbaum Intestinal Clamp**  
Curved

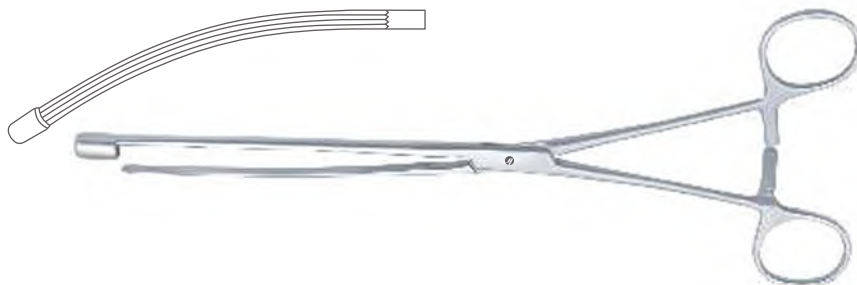

Catalog #	Size
SI-139-25	25 cm (9 3/4")

**Lane Intestinal Clamp**  
Straight

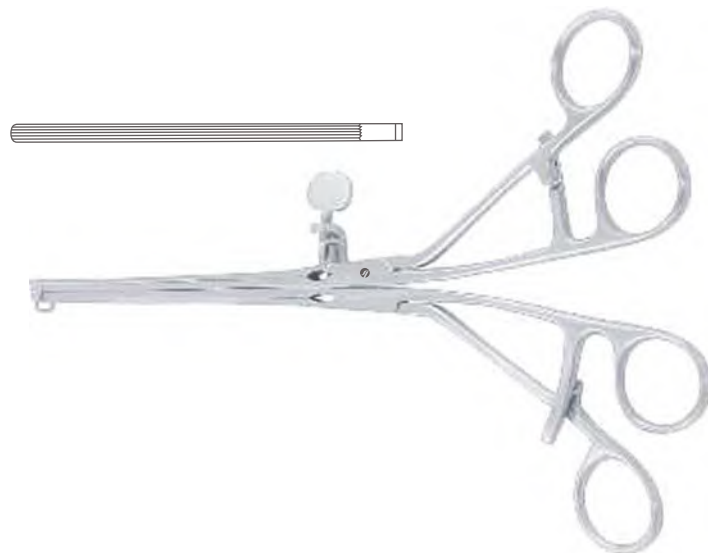

Catalog #	Size
SI-150-30	30 cm (11 3/4")



Intestinal Clamps  
Darmklemmen  
Pinzas intestinales  
Pinces intestinales  
Pinze intestinali

**Lane Intestinal Clamp**  
Curved

Catalog #	Size
SI-151-30	30 cm (11 3/4")

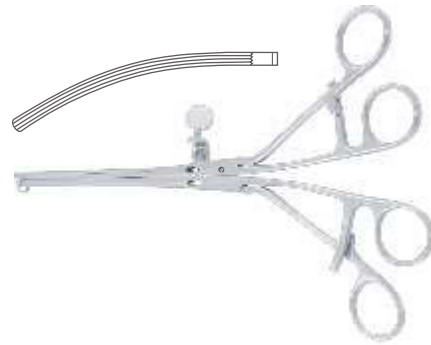

**Haberer Intestinal Clamp**

Catalog #	Size
SI-156-36	36 cm (14 1/4")

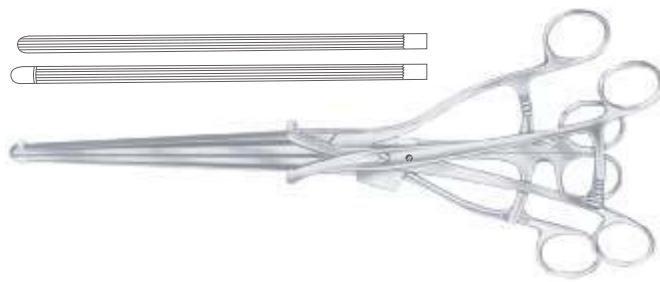

**Scudder Intestinal Clamp**  
Straight

Catalog #	Size
SI-160-33	33.5 cm (13 1/4")

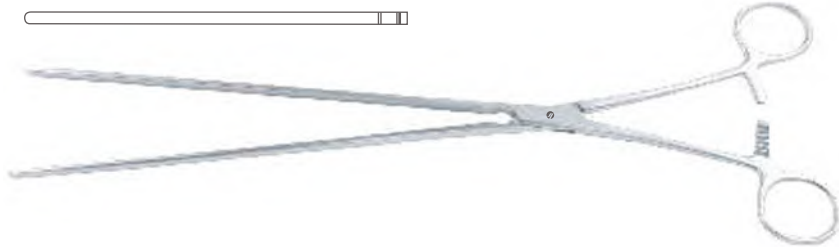

**Scudder Intestinal Clamp**  
Curved

Catalog #	Size
SI-161-33	32.5 cm (12 3/4")

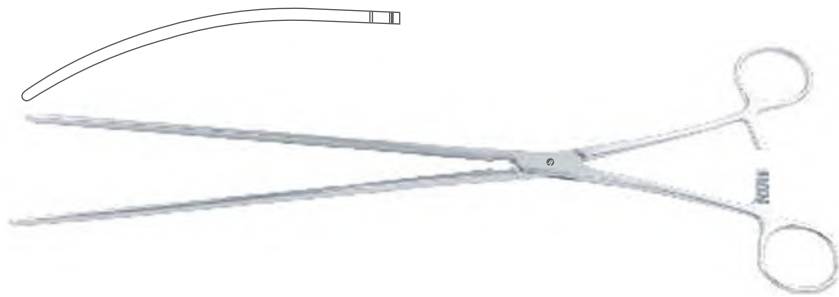

**Brunner Sigmoid Anastomosis Clamp**

Catalog #	Size
SI-165-24	24 cm - (9 1/2")





Intestinal Clamps  
Darmklemmen  
Pinzas intestinales  
Pinces intestinales  
Pinze intestinali

**De Martel-Wolfson Intestinal Anastomosis Clamp**

Set of 3 Ref: SI-172-01 to SI-172-03

Catalog #	Size
SI-170-00	Standard

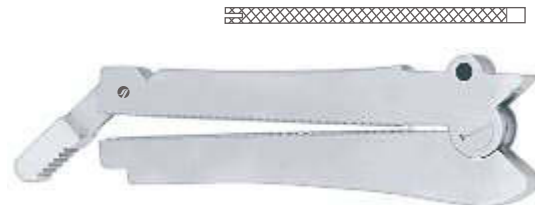

**De Martel-Wolfson Intestinal Anastomosis Clamp**

Catalog #	Jaw Length
SI-172-01	65 mm
SI-172-02	80 mm
SI-172-03	110 mm



**De Martel-Wolfson Closing Forcep**

Catalog #	Size
SI-179-25	25 cm (9 3/4")



**De Martel-Wolfson Clamp Holder**

Catalog #	Size
SI-180-09	9.5 cm (3 3/4")
SI-180-23	23 cm (9")



**Benson Pylorus Spreader**

Catalog #	Size
SI-186-15	15.5 cm (6")





**Scheibe (Collin) Atrauma Organ Grasping**

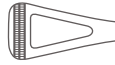

Catalog #	Size, Profile
SI-190-18	18 cm (7"), Narrow Jaw
SI-190-20	20.5 cm (8"), Medium Jaw
SI-190-23	23 cm (8"), Wide Jaw

**Doyen-Baby Atrauma Intestinal Clamp**  
Straight



Catalog #	Size
SI-200-13	14 cm (5")

**Doyen-Baby Atrauma Intestinal Clamp**  
Curved



Catalog #	Size
SI-201-13	13.5 cm (5 1/4")

**Doyen Atrauma Intestinal Clamp**  
Straight

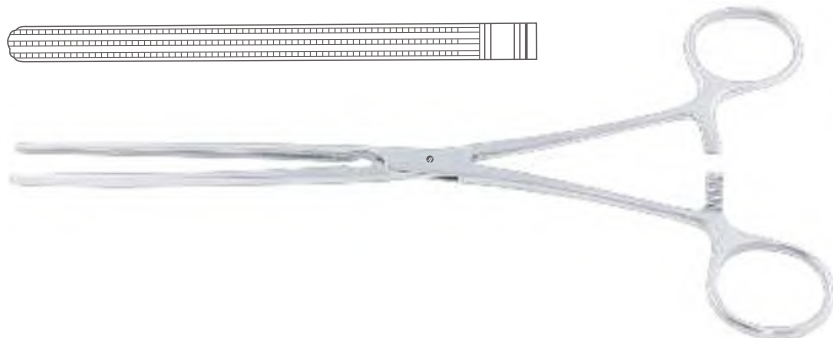
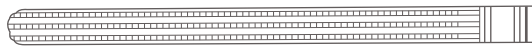

Catalog #	Size
SI-202-16	17 cm (6 3/4")
SI-202-18	18.5 cm (7 1/4")
SI-202-21	21.5 cm (8 1/2")
SI-202-23	23.5 cm (9 1/4")





Intestinal Clamps  
Darmklemmen  
Pinzas intestinales  
Pinces intestinales  
Pinze intestinali

**Doyen Atrauma Intestinal Clamp**  
Curved

Catalog #	Size
SI-203-16	17 cm (6 3/4")
SI-203-18	18 cm (7")
SI-203-21	21 cm (8 1/4")
SI-203-23	23 cm (9")

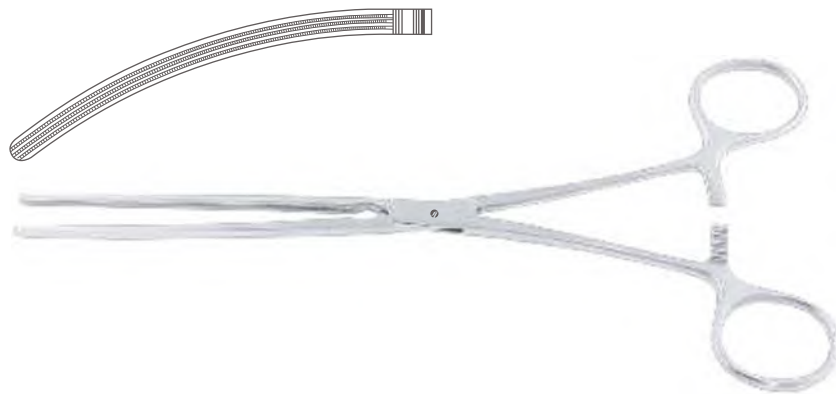

**Mayo-Robson Atrauma Intestinal Clamp**  
Straight

Catalog #	Size
SI-210-25	26 cm (10 1/4")



**Mayo-Robson Atrauma Intestinal Clamp**  
Curved

Catalog #	Size
SI-211-25	25 cm (9 3/4")

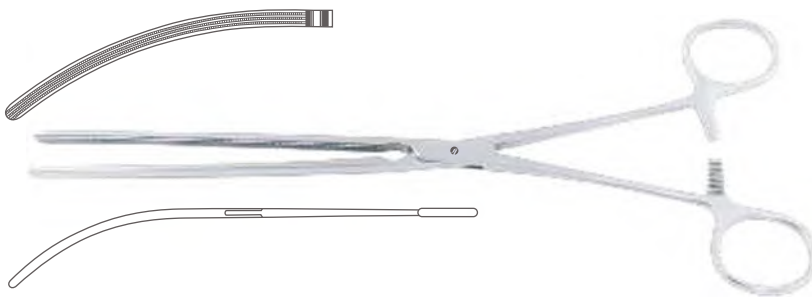

**Kocher Atrauma Intestinal Clamp**  
Straight

Catalog #	Size
SI-220-22	22.5 cm (8 3/4")
SI-220-25	25.5 cm (10")
SI-220-28	28 cm (11")







Intestinal Clamps  
Darmklemmen  
Pinzas intestinales  
Pinces intestinales  
Pinze intestinali

SI

STOMACH, INTESTINES, RECTUM

**Kocher Atrauma Intestinal Clamp**  
Curved

Catalog #	Size
SI-221-22	22 cm (8 3/4")
SI-221-25	25 cm (9 3/4")
SI-221-28	27.5 cm (10 3/4")

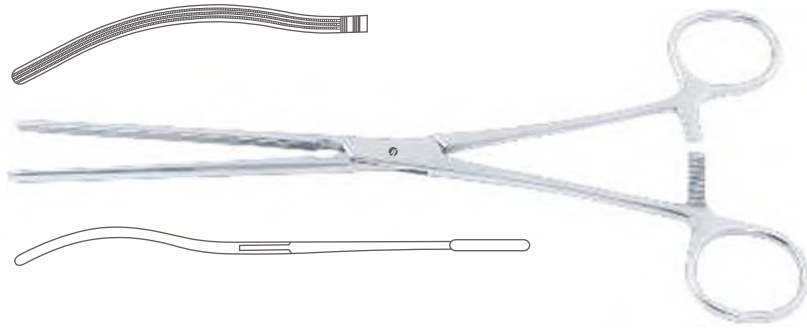

**Scudder Atrauma Intestinal Clamp**  
Straight

Catalog #	Size
SI-230-33	33.5 cm (13 1/4")



**Scudder Atrauma Intestinal Clamp**  
Curved

Catalog #	Size
SI-231-33	32.5 cm (12 3/4")

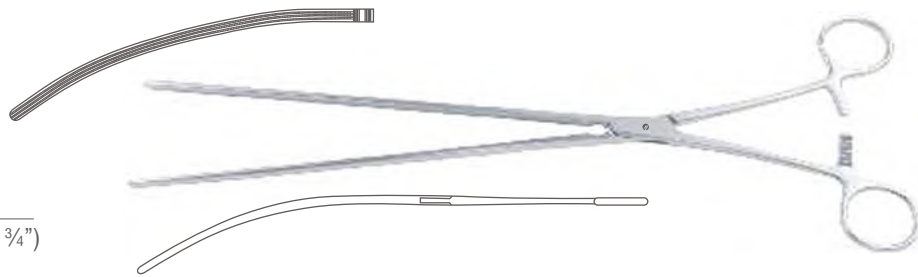

**Brunner Atrauma Sigmoid Anastomosis Clamp**

Catalog #	Size
SI-241-27	27 cm (10 3/4")

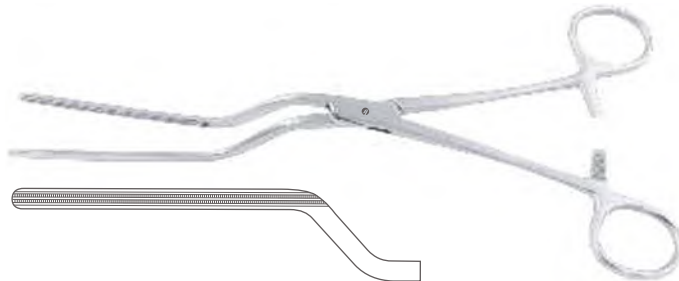

**Hayes Atrauma Sigmoid Anastomosis Clamp**

Catalog #	Size
SI-251-26	27 cm (10 3/4")
SI-251-28	28 cm (11")





Intestinal Clamps, Rectal Specula  
Darmklemmen, Mastdarmspekula  
Pinzas intestinales, Espéculos rectales  
Pinces intestinales, Spéculum rectaux  
Pinze intestinali, Specoli rettali

**Veidenheimer Atrauma Sigmoid Anastomosis Clamp**

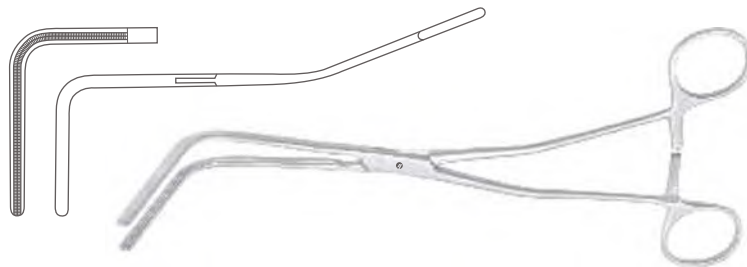

Catalog #	Size
SI-255-23	25 cm (9 3/4")

**Fehland Atrauma Sigmoid Anastomosis Clamp**



Catalog #	Size
SI-259-24	24 cm (9 1/2")

**Resano Atrauma Sigmoid Anastomosis Clamp**

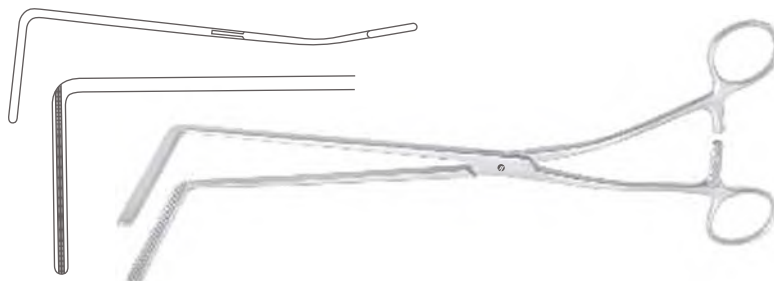

Catalog #	Size
SI-261-30	28 cm (11")

**Czerny Rectal Speculum**



Catalog #	Size
SI-301-22	22 cm (8 3/4")

**Pratt Rectal Speculum**



Catalog #	Size, Blade Size
SI-311-20	20.5 cm (8"), 80 x 25 mm



Rectal Specula  
Mastdarmspekula  
Espéculos rectales  
Spéculums rectaux  
Specoli rettali

**Sims Rectal Speculum**



Catalog #	Size, Blade Size
SI-321-15	15.5 cm (6"), 70 x 15 mm

**Sims Rectal Speculum**  
With Fiber Optic Illumination



Fiber Optic No Shown

Catalog #	Size
SI-323-15	15.5 cm (6")

**Sims Rectal Speculum**  
Fenestrated Blades



Catalog #	Size, Blade Size
SI-327-15	15.5 cm (6"), 70 x 15 mm

**Sims (Schulze-Bergmann) Rectal Speculum**



Catalog #	Size, Blade Size
SI-331-01	22 cm (8 3/4"), 60 mm
SI-331-02	22 cm (8 3/4"), 80 mm
SI-331-03	22 cm (8 3/4"), 125 mm
SI-331-04	22 cm (8 3/4"), 150 mm

**Sims (Schulze-Bergmann) Rectal Speculum**  
With Fiber Optic Illumination



Fiber Optic No Shown

Catalog #	Size
SI-335-22	22 cm (8 3/4")



Rectal Specula  
Mastdarmspekula  
Espéculos rectales  
Spéculums rectaux  
Specoli rettali

**Mathieu Rectal Speculum**



Catalog #	Size, Blade Length
SI-341-19	19.5 cm (7 3/4"), 90 mm

**Barr Rectal Speculum**



Catalog #	Size, Blade Size
SI-343-17	17 cm (6 3/4"), 70 x 22 mm

**Parks Rectal Speculum**



Catalog #	Size
SI-351-00	Standard

**Parks Rectal Speculum  
With Fiber Optic Illumination**

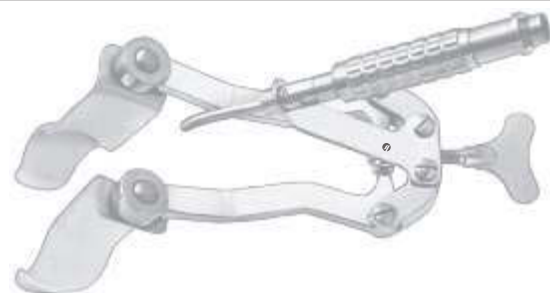

Catalog #	Size
SI-355-00	Standard

**Alan-Parks Rectal Speculum**



Catalog #	Size
SI-361-00	Standard



Rectal Spreaders, Anuscope  
Analspreizer, Anuskop  
Separadores rectales, Anoscopio  
Ecarteurs rectaux, Anuscope  
Divaricatori rettali, Anoscopio

**Alan-Parks Rectal Speculum**  
With Fiber Optic Illumination

Catalog #	Size
SI-365-00	Standard



**Roschke Anal Retractor**

Catalog #	Blade Size
SI-371-00	70 x 30 mm



**Roschke Anal Retractor**  
With Fiber Optic Illumination

Catalog #	Blade Size
SI-375-00	70 x 30 mm



**Hirschmann Anoscope**

Catalog #	Diameter, Working Length, Profile
SI-381-01	Ø 16 mm, 60 mm, Fig. 1
SI-381-02	Ø 19 mm, 70 mm, Fig. 2
SI-381-03	Ø 24 mm, 90 mm, Fig. 3
SI-381-04	Ø 24 mm, 130 mm, Fig. 4



**Hirschman Anoscope**  
With Fiber Optic Illumination

Catalog #	Diameter, Working Length, Profile
SI-385-01	Ø 16 mm, 60 mm, Fig. 1
SI-385-02	Ø 19 mm, 70 mm, Fig. 2
SI-385-03	Ø 24 mm, 90 mm, Fig. 3
SI-385-04	Ø 24 mm, 130 mm, Fig. 4





Anuscope  
Anuskop  
Anoscopio  
Anuscope  
Anoscopio

**Ives-Fansler Anoscope**



Catalog #	Diameter, Working Length
SI-391-00	Ø 22 mm, 95 mm

**Ives-Fansler Anoscope  
With Fiber Optic Illumination**



Catalog #	Diameter, Working Length
SI-395-00	Ø 22 mm, 95 mm

**Anoscope  
With Obturator**



Catalog #	Diameter, Working Length
SI-401-00	Ø 21 mm, 80 mm

**Anoscope  
With Obturator**



Catalog #	Diameter, Working Length
SI-403-01	Ø 26 mm, 60 mm
SI-403-02	Ø 24 mm, 80 mm

**Kelly Proctoscope**



Catalog #	Diameter, Working Length, Profile
SI-411-01	Ø 22 mm, 50 mm, Fig. 1
SI-411-02	Ø 22 mm, 100 mm, Fig. 2
SI-411-03	Ø 22 mm, 140 mm, Fig. 3
SI-411-04	Ø 22 mm, 200 mm, Fig. 4



Proctoscopes  
Proktoskope  
Proctoscopios  
Proctoscopes  
Protoscopi

**Proctoscope**  
With Obturator



Catalog #	Diameter, Working Length
SI-415-00	Ø 22 mm, 120 mm

**Blond Proctoscope Complete**

With Conventional Illumination and Tube Ref: SI-440-01



Catalog #	Size
SI-431?-00	Standard

**Battery Handle Only**

For 2 x "C" Type Batteries



Catalog #	Size
SI-431-01	Standard

**Head End Only**



Catalog #	Size
SI-431-02	Standard

**Bulb**

Head End Only



Catalog #	Power Rating
SI-431-09	2.5





Proctoscopes  
Proktoskope  
Proctoscopios  
Proctoscopes  
Protoscopi

**Bulb**  
Short for Head End Only



Catalog #	Power Rating
SI-431-10	2.5

**Blond Proctoscope Complete**  
With Fiber Optic Illumination and Tube Ref: SI-440-01



Catalog #	Size
SI-435-00	Standard

**Illumination Handle only**  
With Head End



Catalog #	Size
SI-435-01	Standard

**Adaptor**  
Storz Type



Catalog #	Size
SI-435-05	Standard

**Blond Proctoscope Tube**



SI-440-01



SI-440-02



SI-440-03

Catalog #	Diameter, Working Length
SI-440-01	Ø 18:24 mm, 75 mm
SI-440-02	Ø 15:23 mm, 75 mm
SI-440-03	Ø 18:25 mm, 105 mm





Proctoscopes  
Proktoskope  
Proctoscopios  
Proctoscopes  
Protoscopi

**Blond Proctoscope Tube**  
Circular Fenestration



Catalog #	Diameter, Working Length
SI-442-01	Ø 18:24 mm, 75 mm

**Morgan Proctoscope**  
With Fiber Optic Illumination



Catalog #	Diameter, Working Length
SI-451-01	Ø 17 mm, 65 mm
SI-451-02	Ø 17 mm, 80 mm
SI-451-03	Ø 20 mm, 65 mm
SI-451-04	Ø 20 mm, 80 mm
SI-451-05	Ø 24 mm, 65 mm
SI-451-06	Ø 24 mm, 80 mm

**Morgan Fibre Optic Illuminator**  
Connectors Type Storz, Wolf, ACM



Catalog #	Size
SI-455-00	Standard

**Kelly Sphincteroscope**



Catalog #	Diameter, Diameter, Profile
SI-471-01	Ø 21 mm, 50 mm, Fig. 1
SI-471-02	Ø 27 mm, 50 mm, Fig. 2



Sphincteroscopes, Rectoscopes  
Sphinkteroskope, Rektoskope  
Esfincteroscopios, Rectoscopios  
Sphinctérosopes, Rectoscopes  
Sfincteroscopi, Rectotoscopi

**Rectoscope Complete**

Catalog #	Size
SI-500-00	Standard



**Strauss Rectoscope Complete**

Catalog #	Size
SI-510-00	Standard



**Recto-Proctoscope Complete**

Catalog #	Size
SI-520-00	Standard

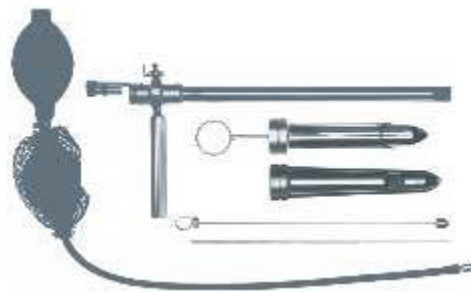

**Battery Handle Only**

For 2 x "AAA" Type Batteries

Catalog #	Size
SI-530-01	Standard



**Spare Bulb**  
Xenon

Catalog #	Power Rating
SI-530-09	2.5 V





Sphincteroscopes, Rectoscopes  
Sphinkterskope, Rektoskope  
Esfincteroscopios, Rectoscopios  
Sphinctéroscoptes, Rectoscopes  
Sfincteroscopi, Rectotoscopi

**Adapter**  
Wolf Type

Catalog #	Size
SI-532-01	Standard



**Adapter**  
Storz / Olympus Type

Catalog #	Size
SI-532-02	Standard



**Adapter**  
Storz / Olympus Type / Aesculap Type

Catalog #	Size
SI-532-03	Standard



**Rectoscope Head**  
With 2 Way Stopcock, Connector Type Wolf

Catalog #	Size
SI-534-01	Standard



**Handle for Rectoscope Head**

Catalog #	Size
SI-534-02	Standard





Rectoscopes  
Rektoskope  
Rectoscopios  
Rectoscopes  
Rectotoscopi

**Rectoscope Obturator**

Catalog #	Size
SI-536-01	Standard
SI-536-02	Standard
SI-536-03	Standard



**Rectoscope Tube**

Catalog #	Size
SI-538-01	Standard
SI-538-02	Standard
SI-538-03	Standard



**Fiber Optic Light Guide**

Catalog #	Size
SI-540-01	Standard
SI-540-02	Standard
SI-540-03	Standard



**Conical Tube**

Catalog #	Size
SI-542-01	Standard



**Anuscope  
With Obturator**

Catalog #	Size
SI-544-01	Standard





Rectoscopes  
Rektoskope  
Rectoscopios  
Rectoscopes  
Rectotoscopi

**Telescope**

Catalog #	Size
SI-546-00	Standard



**Swivel Lens**

Catalog #	Size
SI-548-00	Standard



**Cover**

Catalog #	Size
SI-550-00	Standard



**Double-Blower**  
With Luer Lock

Catalog #	Size
SI-560-00	Standard



**Norwood Rectal Snare**

Catalog #	Size
SI-601-30	30 cm (11 3/4")





Hemorrhoidal Ligator  
Hämorrhoidal-Faßzange  
Ligador para hemorroides  
Ligateur pour hémorroïdes  
Legatore emorroidale

**Blue Rectal Aspiration Cannula**  
10 Charr.

Catalog #	Size, Diameter
SI-607-40	40 cm (15 3/4"), Ø 3.3 mm

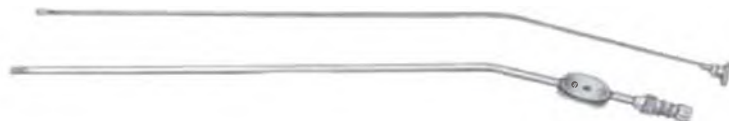

**McGivney Suction Hemorrhoidal Ligator Complete**  
With 10 mm Suction Head and Charging Cone

Catalog #	Size
SI-651-00	Standard



**Suction Hemorrhoidal Ligature Complete**  
Angled 30° Up, With 10 mm Suction Head and Charging Cone

Catalog #	Size
SI-655-00	Standard



**Suction Hemorrhoidal Ligator Complete**  
Angled 30° Down, With 10 mm Suction Head and Charging Cone

Catalog #	Size
SI-657-00	Standard



**Rudd Hemorrhoidal Ligator Complete**  
With 12 mm Charging Cone

Catalog #	Size
SI-670-00	31.5 cm (12 1/2")





Hemorrhoidal Ligator, Rectal Biopsy Forceps  
Hämorrhoidal-Faßzange, Rektum-Biopsiefasszangen  
Ligador para hemorroides, Pinzas para biopsia rectal  
Ligateur pour hémorroïdes, Pincés pour biopsie rectale  
Legatore emorroidale, Pinze per biopsia rettale

**McGivney Hemorrhoidal Ligator Complete**  
With 12 mm Charging Cone



Catalog #	Size
SI-675-00	Standard

**Ford Dixon Hemorrhoidal Ligator Complete**  
With 12 mm Charging Cone



Catalog #	Size
SI-677-00	Standard

**Rubber Ligator Rings**  
Pack of 100



Catalog #	Size
SI-680-00	Standard

**McGivney Hemorrhoidal Grasping Forcep**

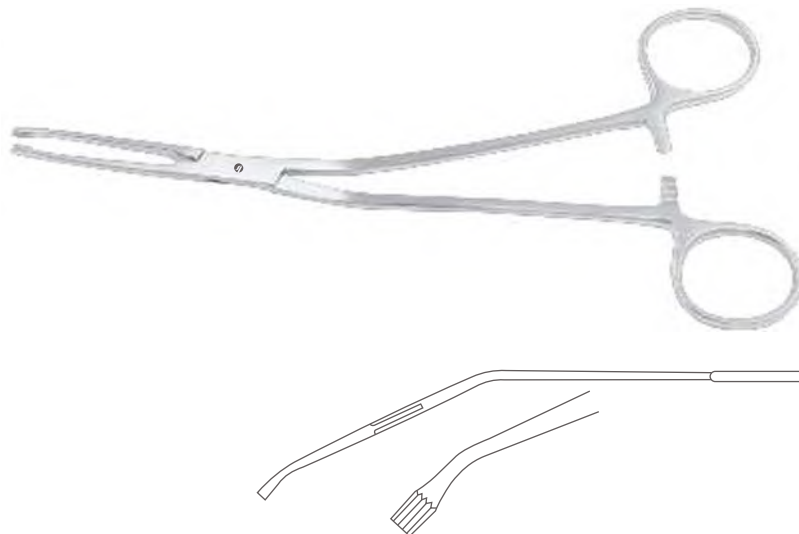

Catalog #	Size
SI-691?-19	19 cm (7 1/2")



Rectal Biopsy Forceps  
 Rektum-Biopsiefasszangen  
 Pinzas para biopsia rectal  
 Pinces pour biopsie rectale  
 Pinze per biopsia rettale

**Yeoman (Turrell) Rectal Biopsy Forcep Without Handle**  
 Rotatable

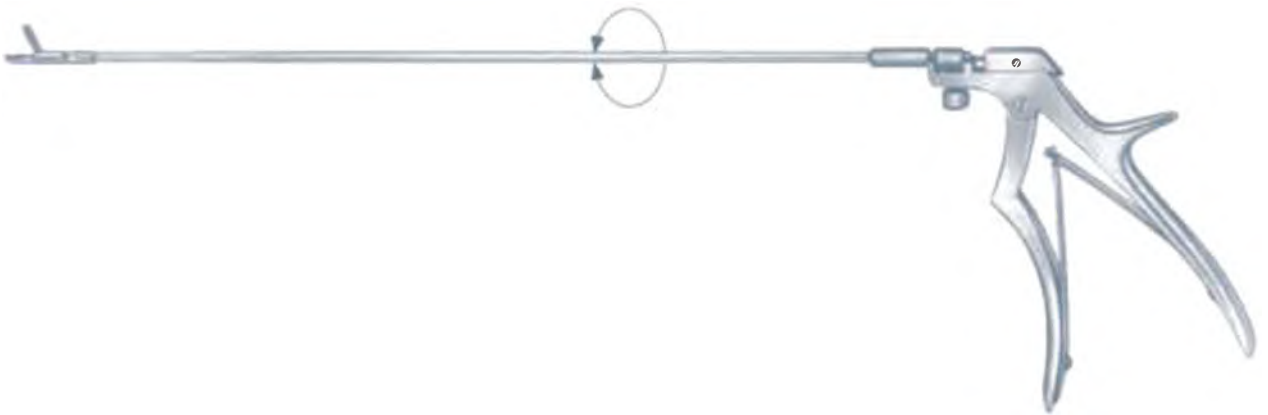

Catalog #	Size
SI-725-42	42 cm (16 1/2"), Straight
SI-727-42	42 cm (16 1/2"), Down
SI-729-42	42 cm (16 1/2"), Straight
SI-731-42	42 cm (16 1/2"), Down
SI-733-42	42 cm (16 1/2"), Straight



SI-725-42, Straight



SI-727-42, Down



SI-729-42, Straight



SI-731-42, Down



SI-733-42, Straight

**Handle Only**

Catalog #	Size
SI-735-00	Standard







Rectal Biopsy Forceps  
Rektum-Biopsiefasszangen  
Pinzas para biopsia rectal  
Pinces pour biopsie rectale  
Pinze per biopsia rettale

**Yeoman (Turrell) Rectal Biopsy Forcep Complete**



Catalog #	Size, Profile
SI-735-01	42 cm (16 1/2"), Straight
SI-735-02	42 cm (16 1/2"), Down
SI-735-03	42 cm (16 1/2"), Straight
SI-735-04	42 cm (16 1/2"), Down
SI-735-05	42 cm (16 1/2"), Straight

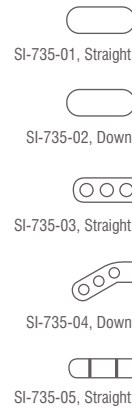





**SURTEX**  
INSTRUMENTS

*Crafted to Excellence*

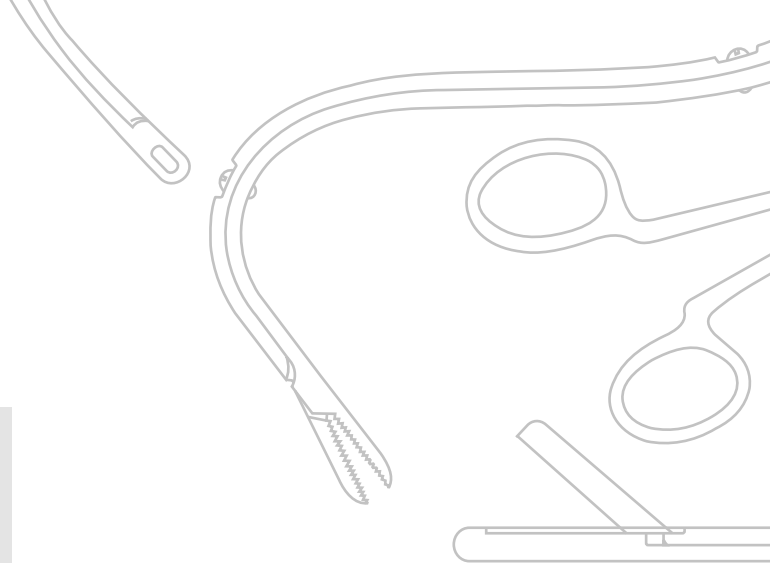

UR



## LIVER, GALL BLADDER, KIDNEY, UROLOGY

Surtext manufactures a broad range of instruments for specialist field of Liver, Gall Bladder, Kidney and Urology surgery. Our range of liver instruments, gall bladder instruments, kidney instruments and urology instruments includes but is not limited to the following non scalpel vasectomy forceps, kidney stone forceps, nephrostomy forceps, gull duct dilators, gall stone forceps, gall stone scoops, prostate retractors, capsule forceps, urethral sounds, female catheters, urethrotomes, circumcision instruments, urethrography instruments, foreign body instruments, penis clamps & hernia instruments.

Leber, Galle, Niere, Urologie

Higado, Biliares, Renales, Urología

Foie, Biliaire, Rénaux, Urologie

Fegato, Biliari, Renali, Urologia



Kidney Stone Forceps  
Nierensteinzangen  
Pinzas para cálculos renales  
Pinces pour les calculs du bassinet  
Pinze per calcoli renali

**Vasectomy Dissecting Forcep**

Catalog #	Size
UR-011-01	Standard



**Vasectomy Fixation Clamp**

Catalog #	Size
UR-014-02	Standard



**Randall Kidney Stone Forcep  
Fig. 1**

Catalog #	Size
UR-051-23	23 cm (9")

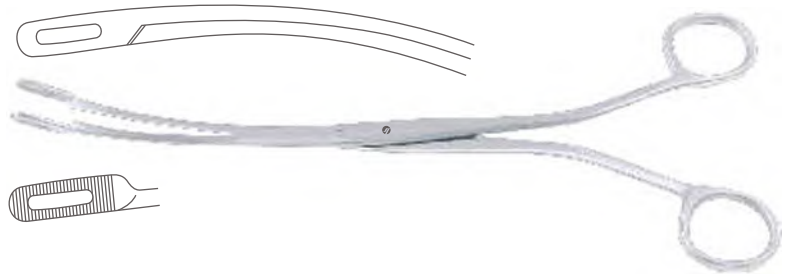

**Randall Kidney Stone Forcep  
Fig. 2**

Catalog #	Size
UR-053-21	21 cm (8 1/4")



**Randall Kidney Stone Forcep  
Fig. 3**

Catalog #	Size
UR-055-19	19 cm (7 1/2")

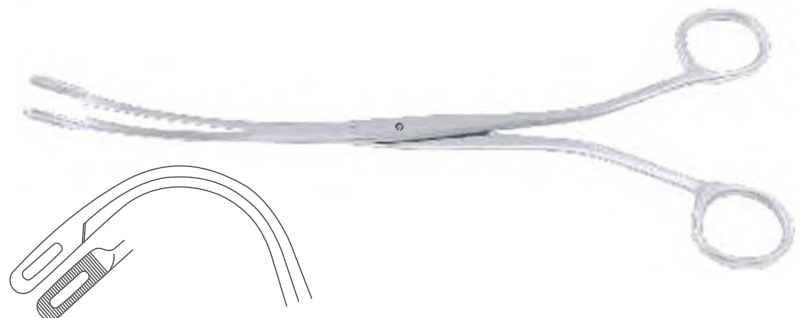



Kidney Stone Forceps  
Nierensteinzangen  
Pinzas para cálculos renales  
Pinces pour les calculs du bassin  
Pinze per calcoli renali

**Randall Kidney Stone Forcep**  
Fig. 4

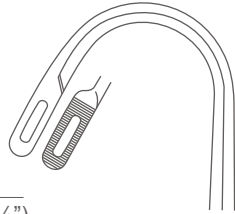

Catalog #	Size
UR-057-18	18.5 cm (7 1/2")



**Randall Kidney Stone Forcep**  
Fig. 5

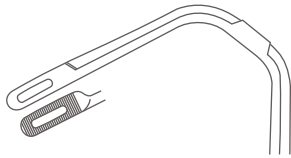

Catalog #	Size
UR-059-19	19 cm (7 1/2")



**Randall Kidney Stone Forcep**  
Fig. 6

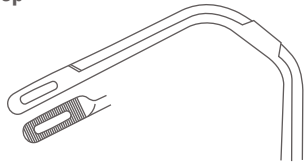

Catalog #	Size
UR-061-19	19 cm (7 1/2")



**Randall Kidney Stone Forcep**  
Fig. 1, Slender Pattern

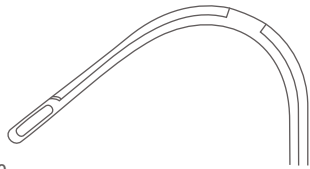

Catalog #	Size
UR-071-23	23 cm (9")



**Randall Kidney Stone Forcep**  
Fig. 2, Slender Pattern

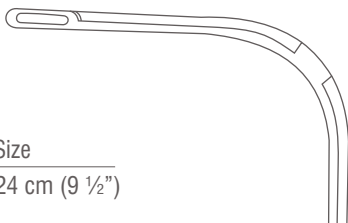

Catalog #	Size
UR-073-24	24 cm (9 1/2")





Kidney Stone Forceps  
Nierensteinzangen  
Pinzas para cálculos renales  
Pinces pour les calculs du bassinet  
Pinze per calcoli renali

**Heiming Kidney Stone Forcep**  
Fig. 1

Catalog #	Size
UR-081-16	16 cm (6 1/4")



**Heiming Kidney Stone Forcep**  
Fig. 2

Catalog #	Size
UR-083-17	17 cm (6 3/4")



**Elsaesser Nephrectomy Forcep**

Catalog #	Size, Profile
UR-091-01	21 cm (8 1/4"), Fig. 1
UR-091-02	21 cm (8 1/4"), Fig. 2

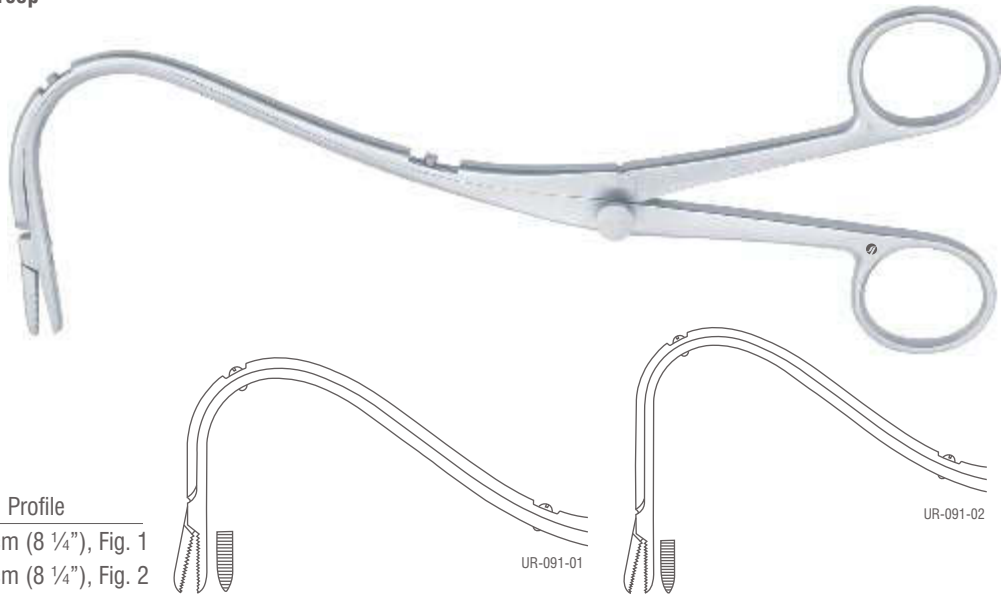

**Bakes Gall Duct Dilators**  
Set of 13 Ref: UR-150-01 to UR-150-13

Catalog #	Size
UR-150-00	Standard





Gall Duct Dilators  
Gallenkanaldilatatoren  
Dilatadores para conducto biliar  
Dilateurs pour les voies biliaires  
Dilatatori per condotti biliari

**Bakes Gall Duct Dilator**



Catalog #	Size, Diameter, Profile
UR-150-01	32 cm (12 1/2"), Ø 1 mm, Fig. 1
UR-150-02	32 cm (12 1/2"), Ø 2 mm, Fig. 2
UR-150-03	32 cm (12 1/2"), Ø 3 mm, Fig. 3
UR-150-04	32 cm (12 1/2"), Ø 8 mm, Fig. 4
UR-150-05	32 cm (12 1/2"), Ø 6 mm, Fig. 5
UR-150-06	32 cm (12 1/2"), Ø 7 mm, Fig. 6
UR-150-07	32 cm (12 1/2"), Ø 8 mm, Fig. 7
UR-150-08	32 cm (12 1/2"), Ø 9 mm, Fig. 8
UR-150-09	32 cm (12 1/2"), Ø 10 mm, Fig. 9
UR-150-10	32 cm (12 1/2"), Ø 11 mm, Fig. 10
UR-150-11	32 cm (12 1/2"), Ø 12 mm, Fig. 11
UR-150-12	32 cm (12 1/2"), Ø 13 mm, Fig. 12
UR-150-13	32 cm (12 1/2"), Ø 13 mm, Fig. 13

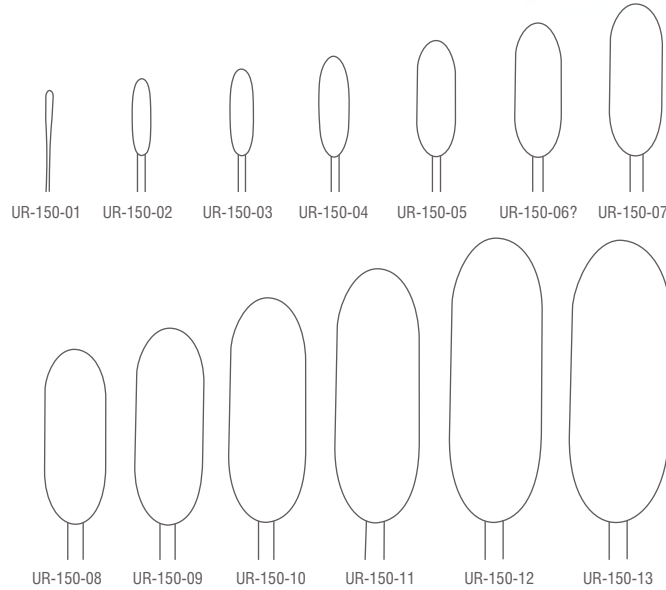

**Bakes Gall Stone Forcep**  
Straight



Catalog #	Size
UR-180-20	21 cm (8 1/4")

**Bakes Gall Stone Forcep**  
Curved



Catalog #	Size
UR-181-20	21 cm (8 1/4")

**Mayo-Bakes Gall Stone Forcep**  
Straight



Catalog #	Size
UR-184-20	21 cm (8 1/4")



Gall Stone Forceps  
Gallensteinzangen  
Pinzas para cálculos biliares  
Pinces pour calculs biliaires  
Pinze per calcoli biliari

**Mayo-Bakes Gall Stone Forcep**  
Curved

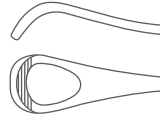

Catalog #	Size
UR-185-20	21 cm (8 1/4")

**Mixer Gall Stone Forcep**



Catalog #	Size
UR-189-22	22 cm (8 3/4")

**Desjardins Gall Stone Forcep**  
Fig. 1



Catalog #	Size
UR-191-23	23 cm (9")

**Desjardins Gall Stone Forcep**  
Fig. 2



Catalog #	Size
UR-193-23	23 cm (9")





Prostatic Retractors  
Prostatahaken  
Separadores para próstata  
Ecarteurs prostatiques  
Divaricatori prostatici

**Luer-Koerte Gall Stone Scoop**

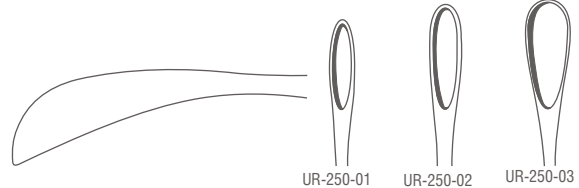

Catalog #	Size, Scoop Size, Profile
UR-250-01	32 cm (12 1/2"), Ø 2.7 mm, Fig. 000
UR-250-02	32 cm (12 1/2"), Ø 3.4 mm, Fig. 00
UR-250-03	32 cm (12 1/2"), Ø 4.3 mm, Fig. 0
UR-250-04	32 cm (12 1/2"), Ø 5.5 mm, Fig. 1
UR-250-05	32 cm (12 1/2"), Ø 6.6 mm, Fig. 2
UR-250-06	32 cm (12 1/2"), Ø 8.0 mm, Fig. 3
UR-250-07	32 cm (12 1/2"), Ø 11.0 mm, Fig. 4
UR-250-08	32 cm (12 1/2"), Ø 15.0 mm, Fig. 5

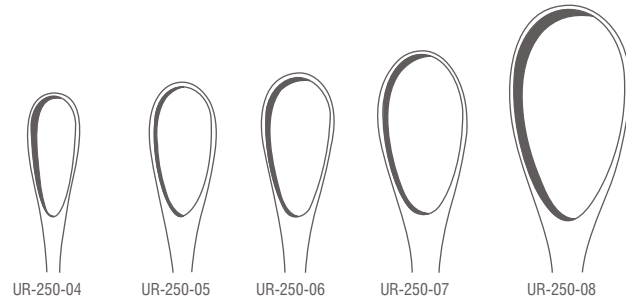

**Young Prostatic Retractor**

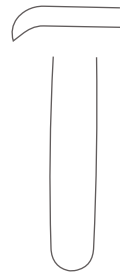

Catalog #	Size
UR-301-22	22 cm (8 3/4")

**Young Prostatic Retractor**

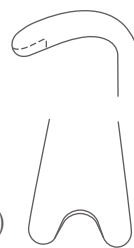

Catalog #	Size
UR-305-21	21.5 cm (8 1/2")

**Young Prostatic Retractor**

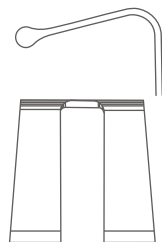

Catalog #	Size
UR-309-23	23 cm (9")



Capsule Forceps  
Kapselasszangen  
Pinzas capsulares  
Pincas pour saisir les capsules  
Pinze per afferrare capsule

**Millin Atrauma Capsule Forcep**

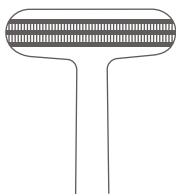

Catalog #	Size
UR-451-24	24.5 cm (9 1/2")

**Millin Atrauma Capsule Forcep**

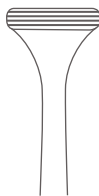

Catalog #	Size
UR-453-22	22.5 cm (8 3/4")

**Millin Capsule Forcep**

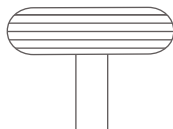

Catalog #	Size
UR-457-24	24.5 cm (9 1/2")

**Millin Capsule Forcep**

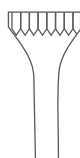

Catalog #	Size
UR-461-22	22 cm (8 3/4")

**Van Buren Urethral Sound / Dilating Bougie**

Set of 15 Ref: UR-501-08 to UR-501-36



Catalog #	Size
UR-501-00	Standard

INCHES  
MILLIMETERS



**Van Buren Urethral Sound / Dilating Bougie**

Catalog #	Size, Profile
UR-501-08	27 cm (10 3/4"), 8 Charr.
UR-501-10	27 cm (10 3/4"), 10 Charr.
UR-501-12	27 cm (10 3/4"), 12 Charr.
UR-501-14	27 cm (10 3/4"), 14 Charr.
UR-501-16	27 cm (10 3/4"), 16 Charr.
UR-501-18	27 cm (10 3/4"), 18 Charr.
UR-501-20	27 cm (10 3/4"), 20 Charr.
UR-501-22	27 cm (10 3/4"), 22 Charr.
UR-501-24	27 cm (10 3/4"), 24 Charr.
UR-501-26	27 cm (10 3/4"), 26 Charr.
UR-501-28	27 cm (10 3/4"), 28 Charr.
UR-501-30	27 cm (10 3/4"), 30 Charr.
UR-501-32?	27 cm (10 3/4"), 32 Charr.?
UR-501-34	27 cm (10 3/4"), 34 Charr.
UR-501-36	27 cm (10 3/4"), 36 Charr.



**Guyon Urethral Sound / Dilating Bougie**

Set of 24 Ref: UR-511-10 to UR-511-30 and UR-580-03 to UR-580-06 in Metal Case

Catalog #	Size
UR-511-00	Standard

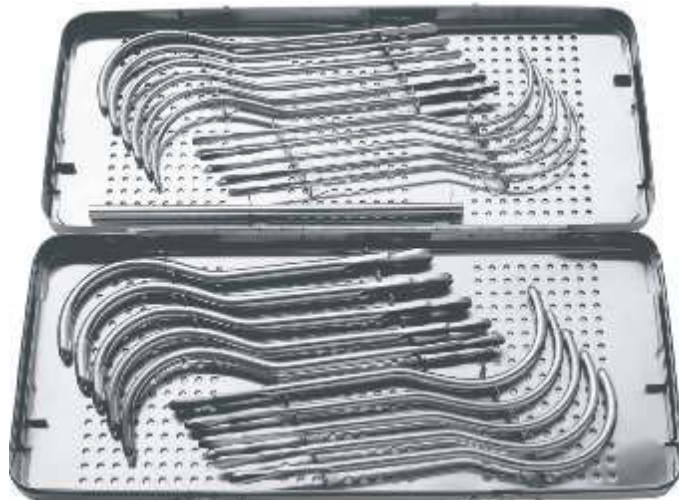



Urethral Sounds  
Harnröhrenbougies  
Bujias uretrales  
Bougies urétrales  
Candelette dilatatrice

**Guyon Urethral Sound / Dilating Bougie**

Catalog #	Size, Profile
UR-511-10	26.5 cm (10 1/2"), 10 Charr.
UR-511-11	26.5 cm (10 1/2"), 11 Charr.
UR-511-12	26.5 cm (10 1/2"), 12 Charr.
UR-511-13	26.5 cm (10 1/2"), 13 Charr.
UR-511-14	26.5 cm (10 1/2"), 14 Charr.
UR-511-15	26.5 cm (10 1/2"), 15 Charr.
UR-511-16	26.5 cm (10 1/2"), 16 Charr.
UR-511-17	26.5 cm (10 1/2"), 17 Charr.
UR-511-18?	26.5 cm (10 1/2"), 18 Charr.
UR-511-19	26.5 cm (10 1/2"), 19 Charr.
UR-511-20	26.5 cm (10 1/2"), 20 Charr.
UR-511-21	26.5 cm (10 1/2"), 21 Charr.
UR-511-22	26.5 cm (10 1/2"), 22 Charr.
UR-511-23	26.5 cm (10 1/2"), 23 Charr.
UR-511-24	26.5 cm (10 1/2"), 24 Charr.
UR-511-25	26.5 cm (10 1/2"), 25 Charr.
UR-511-26	26.5 cm (10 1/2"), 26 Charr.
UR-511-27	26.5 cm (10 1/2"), 27 Charr.
UR-511-28	26.5 cm (10 1/2"), 28 Charr.
UR-511-30	26.5 cm (10 1/2"), 30 Charr.



**Female Catheter**

Catalog #	Size, Profile
UR-515-10	15 cm (6"), 10 Charr.
UR-515-12	15 cm (6"), 12 Charr.
UR-515-14	15 cm (6"), 14 Charr.
UR-515-16	15 cm (6"), 16 Charr.
UR-515-18	15 cm (6"), 18 Charr.
UR-515-20	15 cm (6"), 20 Charr.



**Catheter Introducer**

Catalog #	Size
UR-519-00	46 cm (18")





Urethrotome, Urethrography- and Circumcision Instruments  
Urethrotom, Urethrographie- u. Circumcisions-Instrumente  
Uretrótomo, Instrumentos para uretrografía y circuncisión  
Urétrotome, Instruments pour uréthrographie et circoncision  
Uretrotomi, Strumenti per uretrografia e circoncisione

**Otis Urethrotome**  
With 2 Knives and 3 Tips

Catalog #	Size
UR-550-00	Standard

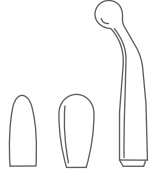

**Otis Spare Blade**

Catalog #	Size
UR-550-01	Standard



**Filiform Urethral Sound / Dilating Bougie**

Catalog #	Profile
UR-580-03	3 Charr.
UR-580-04	4 Charr.
UR-580-05	5 Charr.
UR-580-06	6 Charr.

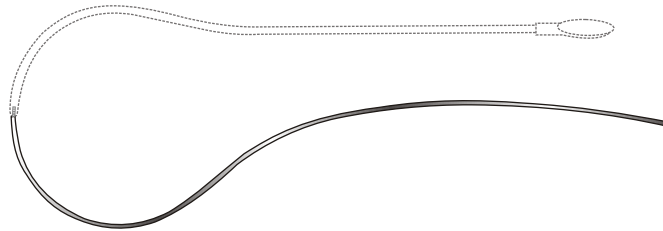

**Knutson Urethrography Instrument**

Catalog #	Size
UR-700-00	Standard





Circumcision Instruments  
Circumcisions-Instrumente  
para uretrografia y circuncisión  
pour urétrographie et circoncision  
per uretrografia e circoncisione

**Gomco Circumcision Clamp**

Catalog #	Diameter
UR-720-08	Ø 8 mm
UR-720-11	Ø 11 mm
UR-720-13	Ø 13 mm
UR-720-16	Ø 16 mm
UR-720-21	Ø 21 mm
UR-720-26	Ø 26 mm
UR-720-32	Ø 32 mm



**Mogen Circumcision Clamp**

Catalog #	Size
UR-740-00	7.5 cm (3")



**Mathieu Foreign Body Forcep**

Catalog #	Size
UR-801-20	20 cm (8")
UR-801-28	28 cm (11")



**Sachse Meatotome**

Catalog #	Size
UR-815-12	Standard





Circumcision Instruments  
Circumcisions-Instrumente  
para uretrografia y circuncisión  
pour urétrographie et circoncision  
per uretrografia e circoncisione

**Stockman Penis Clamp**

Catalog #	Size
UR-851-08	8 cm (3 1/4")



**Strauss Penis Clamp**

Catalog #	Size
UR-861-11	11 cm (4 1/2")



**Collingwood-Stewart Hernia Ring Forcep**

Catalog #	Size
UR-870-13	13 cm (5")









## TERMS & CONDITIONS

### 1. Definitions

**Company** means Surtex Instruments Ltd (registered in the United Kingdom under registration number 7035724).

**Customer** means the company, firm or organization who's Order for the Goods is accepted by the Company.

**Contract** means the Order accepted by the Company and incorporating these conditions.

**Goods** means the goods which the Company agrees to supply in accordance with these conditions and which are identified on the Order.

**Order** means the order for the purchase of the Goods submitted by the Customer.

- i. Any reference to a law is a reference to it as in force for the time being taking account of any amendment, extension, application or re-enactment and includes any subordinate legislation for the time being in force made under it.
- ii. Where a condition provides for a list of items following the word "including" or "includes", then such list is not to be interpreted as being an exhaustive list.

### 2. Incorporation of Conditions

- i. These conditions shall apply to the Contract to the exclusion of all other terms and conditions, including any terms and conditions which the Customer may purport to apply under any order (including the Order), confirmation of order or similar document or in any correspondence.
- ii. No variation to these conditions shall be binding unless agreed in writing by an authorized representative of the Company.
- iii. The Contract constitutes the entire understanding between the Company and the Customer with respect to the Goods and supersedes all previous agreements and understandings between the parties. The Customer acknowledges that it has not relied upon any statement made orally or in writing by the Company, its employees or agents to the Customer, which are not expressly incorporated into the contract.

### 3. Ordering

- i. Each order (whether submitted by telephone, fax, post, email or electronic ordering system) shall be deemed to be an offer by the Customer to purchase the Goods pursuant to these conditions. The Company may, at its complete discretion, refuse to accept any Order.
- ii. The Customer shall be responsible to the Company for ensuring the accuracy of the terms of any Order (including the description of the Goods ordered).

#### Samples and Free of Charge Goods

- iii. For the avoidance of doubt, where no order is placed and the Company provides Samples, to familiarize the Customer with the goods, as part of a sampling program or where the Company provides Free of Charge Goods to the Customer as part of a clinical trial or compassionate use program these conditions shall, to the extent applicable, apply to such Samples and Free of Charge Goods.

### 4. Price and Payments

- i. Subject to the condition 4.5, unless and otherwise agreed by the Company in writing, the price of the Goods shall be the price listed in the Company's published price list current at the date of the Company's acceptance of the Order. Subject to the condition 4.4, any price may be altered from time to time by the Company on giving not less than thirty days notice to the Customer.
- ii. Standard delivery shall be in accordance with the condition 6.1 or as stated on the Pro Forma offer whichever is greater. If the Customer requires delivery within an alternative time period, the Customer shall contact the Company's customer Support Centre to agree an alternative time period, which will be charged at an additional cost to the Customer. All delivery times are subject to the Goods being in stock at the time of the Company's acceptance of the Order.
- iii. The price is exclusive of VAT and all other applicable taxes and duties, which the Customer shall be additionally liable to pay the Company.
- iv. The Company reserves the right, by giving notice to the Customer at any time before delivery, to increase the price of the Goods to reflect any increase in the cost of the Company which is due to any factor beyond the reasonable control of the Company.
- v. The Customer shall pay the price within ten days of the date of the Company's invoice (the "Due Date"). In the case of payment other than by cash, payment shall only be deemed to have been made on receipt of cleared funds. The time of payment of the price shall be of the essence.
- vi. If the Customer fails to make payment on the due date then the Company shall be entitled to charge the Customer interest (both before and after judgment) on the amount unpaid, in accordance with the Late Payment of Commercial Debts (Interest) Act 1998.
- vii. The Customer shall not in any circumstances or for any reason whatsoever be entitled to make any deduction or withhold any sum from the price by way of set-off or otherwise.
- viii. All payments payable to the Company under the Contract shall become due immediately on its termination, despite any other provision.

### 5. The Goods

- i. The quantity and description of the Goods shall be as set out in the Order.
- ii. The Goods shall be supplied in accordance with the description in the Order. The Company may from time to time make changes to the specification(s) of the Goods, which are required to comply with any applicable safety or statutory requirements or which do not materially affect the quality or fitness for purpose of the Goods.
- iii. The specifications and designs of the Goods (including the copyright, design right and other intellectual property in them) shall as between the parties be and remain the property of the Company.
- iv. The Customer undertakes not to use any trademarks or trade names applied by the Company to the Goods, nor do or permit anything to be done where by the good will or reputation of such trademarks or trade names may be prejudiced or damaged.
- v. All samples must be clearly identified as such, and the Customer must not sell any Samples to any third party.

### 6. Delivery

- i. Subject to the conditions 4.2 and 6.2, delivery of the Goods shall be made to the delivery address specified in the Order normally within 30 days or as stated on the Pro Forma Invoice whichever is greater after the date of the Company's acceptance of the Order.
- ii. The Company reserves the right to withhold delivery of any Goods if any sum due to the Company under any contract with the Customer is overdue or if, in the reasonable opinion of the Company, the financial standing of the customer has been impaired for any other reason.
- iii. Time of delivery shall not be of the essence and, subject to condition 8.6; the Company shall not be liable for any loss or damage whatever due to any failure by the Company to deliver the Goods (or any of them) promptly or at all.



- iv. The Company may deliver the Goods by separate installments. Each separate installment shall be invoiced and paid for in accordance with the provisions of the Contract. Each installment shall be a separate Contract and no cancellation or termination of any Contract relating to an installment shall entitle the Customer to repudiate or cancel any other Contractor installment.
- v. The Customer shall take delivery of the Goods promptly whenever they are tendered for delivery (which shall include signing the relevant delivery note). If, for any reason, the Customer fails to take such delivery of the Goods or otherwise causes or requests a delay in delivery:
  - a. The Goods shall be deemed to have been delivered;
  - b. Risk in Goods shall pass to the Customer; and
  - c. The Company shall be entitled to store or arrange for the storage of the Goods until actual delivery, and charge the Customer for the reasonable costs (including insurance) of such storage and any additional charges incurred in delivering the Goods at a later date.
- vi. The Customer shall ensure that adequate and safe facilities and procedures exist at the Customer's premises for the delivery of the Goods.
- vii. The Customer shall immediately notify the Company's Customer Support Centre if the Goods are not received within 30 days of receipt of the invoice.

#### Acceptance of the Goods

- viii. Subject to condition 6.9, the Customer shall be deemed to have accepted the Goods seven days after the date of delivery to the Customer. After acceptance, the Customer shall not be entitled to reject Goods which are not in accordance with the terms of the Contract and the Company shall have no liability whatsoever to the customer in respect of the Goods.
- ix. The Customer must notify to the Company's Customer Support Centre any alleged defect, shortage in quantity, damage, loss or failure to comply with description within seven days of receipt and hold the Goods for inspection by the Company.

#### Return of the Goods

- x. Any requests to return Goods must be made to the Company's Customer Support Centre within seven days after the date of delivery of the Goods to the Customer. Goods which have specialist storage requirements or short expiry dates will not be accepted for return.
- xi. If the company agrees to accept any Goods for return, the Company will issue a "return reference number" and the Customer shall be liable to pay a handling charge of 20% of the price. No return will be accepted after 15 days. Custom-made, made to order, color-coded, etched, and specially sourced instruments are non-returnable. Instruments that have been used/sterilized are also non-returnable. All products being returned should be sent in their original unopened packaging. All Goods must be returned to the Company carriage-paid. The Customer must provide the Company with proof of carriage. For the avoidance of doubt, the Goods shall be at the Customer's risk until return delivery is accepted by the Company.
- xii. Goods returned without the prior written approval of the Company may be returned to the Customer at the absolute discretion of the Company.

#### Recall of the Goods

- xiii. In the event that any Goods are subject to be called by the Company, the Customer shall provide to the Company as much information as is reasonably possible regarding the whereabouts of the Goods.

#### 7. Title and Risk

- i. The Goods shall be at the Customer's risk at the time of delivery, unless the parties have agreed in writing that the Goods are to be collected from the Company's premises, in which case, the Goods shall be at the Customer's risk when the Company notifies the Customer that the Goods are available for collection.
- ii. Property in the Goods shall not pass from the Company until:
  - a. The Customer has paid the price in full; and
  - b. No other sums whatsoever are due from the Customer to the Company.
- iii. Until property in the Goods passes to the Customer in accordance with the condition 7.2, the Customer shall:
  - a. Hold the Goods on a fiduciary basis as bailed for the Company;
  - b. Store the Goods separately from all other goods in its possession and mark them in such a way that they are clearly identified as the Company's property; and
  - b. Maintain the Goods in satisfactory condition and keep them insured on the Company's behalf for their full price.
- iv. The Customer may sell at full market value or use the Goods only in the ordinary course of the Customer's business. Any such sale or dealing shall be a sale or use of the Company's property on the Customer's own behalf and the Customer shall deal as principal when making such sales or dealings. Until property in the Goods passes from the Company, the proceeds of sale or otherwise of the Goods, to the full extent of the price of the Goods, shall be held in trust for the Company and shall not be mixed with other money or paid in to any over drawn bank account and shall be at all material times identified as the Company's money.
- v. The Company shall be entitled to recover the price notwithstanding that property in any of the Goods has not passed from the Company.
- vi. Until such time as property in the Goods passes from the Company, if the Customer:
  - a. Enters into liquidation or has a winding up order made against it or has an administrator, receiver or manager appointed in respect of its assets; or
  - b. Fail to make payment in accordance with these conditions, the Customer shall upon request deliver up to the Company such of the Goods as have not ceased to be in existence or resold. If the Customer fails to do so, the Company may enter upon any premises owned, occupied or controlled by the Customer where the Goods are situated and repossess the Goods.
- vii. The Customer shall not pledge or in any way charge by way of security for any indebtedness, any of the Goods which are the property of the Company. If the Customer does so, all sums whatever owing by the Customer to the Company shall forth with become due and payable.
- viii. On termination of the Contract, howsoever caused, the Company's rights contained in this condition 7 shall remain in effect.

#### 8. Warranties and Liability

- i. Subject as expressly provided in the Contract, all warranties, conditions or other terms implied by statute or common law are excluded to the fullest extent permitted by law.
- ii. Subject as expressly provided in the Contract, all terms and conditions, warranties and representations (whether implied or made expressly) whether by the Company, its servants or agents or otherwise relating to the quality and /or fitness for the purposes of the Goods are excluded to the fullest extent permitted by the law.
- iii. The Company shall be under no liability in respect of any damage arising from fair wear and tear. Fire or accident, will full damage, negligence, abnormal working conditions, failure to follow the Company's instructions. Misuse [or unauthorized installation, alteration or repair] of the Goods. The Customer must pass the Company's instructions on to any purchasers or potential users of the Goods.



- iv. The Customer shall indemnify the Company for any losses incurred by the Company in respect of any claim brought for:
  - a. Use of Goods by the Customer in breach of section 6 of the Health and Safety at Work Act etc 1974 or any other relevant safety legislation; or
  - b. Infringement of any patent, copyright or other third party intellectual rights relating to the Goods by the customer.
- v. The Company shall not be liable to the Customer for any indirect or consequential losses (including indirect loss of profit, loss of use, loss of production, loss of business, loss of business opportunity, loss of business revenue and loss of good will) arising under or in connection with the Contract.
- vi. Subject to the condition 8.8, when any valid claim in respect of the Goods is notified to the Company in accordance with these conditions, the Company shall be entitled to repair or replace the Goods (or the part in question) or, at the Company's sole discretion, refund to the Customer the price of the Goods (or proportionate part of the price), and the Company shall have no further liability to the Customer.
- vii. Subject to the condition 8.8, the entire liability of the Company arising under or in connection with the performance of the Contract howsoever arising shall not exceed £5,000,000 (in line with the NHS Purchasing and Supply Agency conditions of contract for the purchase of goods).
- viii. Nothing in these conditions shall exclude or limit the liability of the Company for death or personal injury caused by the Company's negligence, fraud or fraudulent misrepresentation, or any other matter in relation to which it would be illegal for the Company to exclude or attempt to exclude its liability.

#### 9. Force Majeure

- i. The Company shall not be responsible for any failure to fulfill its obligations under these conditions and/or in relation to the Goods if such failure is caused by an event which is beyond its reasonable control including acts of God, war, armed conflict, acts of terrorism, riot, strikes, industrial action (including action involving the Company's employees), fire, flood, any natural disaster, any defaults by the Company's suppliers or subcontractors, difficulties obtaining workmen or materials, and breakdown of machinery.
- ii. If such event continues for more than one month, the Company may terminate the Contract without liability.

#### 10. Assignment

- i. The Company may assign the Contractor any part of it to any company, firm or organization.
- ii. The Customer shall not be entitled to assign the Contractor any part of it without the prior written consent of the Company (such consent not to be unreasonably withheld or delayed).

#### 11. Export

- i. Where the Customer intends to export the Goods from the United Kingdom, the Customer shall be responsible for obtaining all necessary licenses and complying with all applicable legislation and regulations governing the export of the Goods from the United Kingdom and the importation of the Goods into the country of destination and shall be responsible for the payment of all duties on the Goods.

#### 12. Miscellaneous

- i. All communications between the parties about the Contract shall be in writing and delivered by pre-paid first class post or by hand to the party's registered office, principal place of business or such other address as may at the relevant time have been notified pursuant to this provision to the party giving notice. In the absence of evidence of earlier receipt, any notices shall be deemed to be duly served:
  - a. If sent by first class post, two working days after posting; or
  - b. If delivered personally, when left at the relevant address.
- ii. Save as required to be disclosed by law:
  - a. Where the Customer is an NHS body, both parties, their employees and agents shall at all times keep confidential and secret and shall not disclose to any person the price or specification relating to the Goods (unless otherwise published); or
  - b. Where the Customer is not an NHS body, both parties, their employees and agents shall at all times keep confidential and secret and shall not disclose to any person any information, materials or documents acquired in connection with the Contract which concerns the other party, its employees or business, Unless otherwise disclosed other than due to a failure of the relevant party to comply with the Contract. On termination of the Contract, howsoever caused, the parties' obligations contained in this condition 12.2 shall remain in effect.
- iii. Neither party, its employees or agents shall offer, give or agree to give to any person any gift or consideration of any kind as an inducement or reward for doing or for bearing to do, or for having done or for borne to do, any action in relation to the obtaining or execution of any contract with the other party.
- iv. Each right or remedy of the Company under these conditions is without prejudice to any other right or remedy of the Company.
- v. On termination of the Contract, howsoever caused, all obligations which are expressed to remain in effect shall survive termination of the Contract, together with such conditions the survival of which is implied or is necessary for the interpretation or enforcement of the Contract.
- vi. A person who is not a party to the Contract shall have no rights pursuant to the Contracts (Rights of Third Parties) Act 1999 to enforce any terms of such contract.
- vii. If any provision of the Contract is held to be wholly or partly illegal, invalid, void, voidable, unenforceable or unreasonable it shall. To the extent of such illegality, invalidity, voidness, voidability, unenforceability or unreasonableness, be deemed to be severable and the remaining provisions of the Contract and the remainder of the provision shall continue in full force and effect.
- viii. No waiver or forbearance by the Company (whether express or implied) in enforcing any of its rights under these conditions shall prejudice its right to do so in the future.
- ix. These conditions are subject to the law of England and Wales. All disputes arising in relation to these conditions or the Contract shall be subject to the exclusive jurisdiction of the courts of England and Wales.

ALPHABETICAL INDEX



**SURTEX**  
INSTRUMENTS

*Crafted to Excellence*



## Alphabetical Index

### A

	Page
Abdominal Spatula	325
Abraham Tonsil Knife	22
Adlercreutz Dissecting Forcep	152-153
Adson	
Dissecting Forcep	153, 211
Dressing Forcep	144, 211
Haemostatic Forcep	240
Needle Holder	430
Periosteal Elevator	563
Retractor Self-Retaining Retractor	336-337, 343-344
Suction Tube	401
Adson-Baby Dissecting & Ligature Forcep	251
Adson-Brown Dissecting Forcep	154, 211
Adson-Micro	
Dissecting Forcep	153
Dressing Forcep	144
Adson-Mini	
Dissecting Forcep	153
Dressing Forcep	144
Adventitia Micro Scissor	108
Akahoshi Phaco PreChopper	203
Alan-Parks Rectal Speculum	620-621
Albee Burr	503
Albee Pointed Cutter	503
Alderdyce Periosteal Elevator	565
Alexander	
Bone Chisel	522
Bone Gouge	522
Periosteal Elevator	562
Alfonso Nucleus Grasping Forcep	203
Allen Intestinal Clamp	611
Allis Intestinal & Tissue Grasping Forcep	606-607
Allis-Adair Intestinal & Tissue Grasping Forcep	606
Allis-Baby Intestinal & Tissue Grasping Forcep	606
Allport Wound Spreader	332
Alm Wound Spreader	332
Anaestophon Stethoscope	390
Anderson-Adson Self-Retaining Retractor	334
Anoscope	622
Anvil Nail Extracting Forcep	599
Arruga	
Capsule Forcep	203
Micro Needle Holder	439
Needle Holder	440, 457
Aston Facelift Scissor	48
Austin Micro Suturing Forcep	168

### B

	Page
Babcock Intestinal & Tissue Grasping Forcep	608
Babinsky Percussion Hammer	388
Backhaus Towel Clamp	275
Bainbridge Haemostatic Forcep	245
Baird Chalazion Forep	208
Bakes Gall Duct Dilators	637-638
Bakes Gall Stone Forcep	638
Balfour Modell USA Retractor	362
Balfour Self Retaining Retractor	360-362
Balfour-Baby Self Retaining Retractor	360
Bandage Scissor	93
Baron-Schuknecht Suction Tube	403
Barr Rectal Speculum	620
Barraquer	
Blade Breaker	25
Cilia Forcep	187
Iris Scissor	99
Micro Needle Holder	442-444, 455
Barraquer-Troutman Micro Needle Holder	441-442
Barre	
Dissecting & Ligature Forcep	261
Vascular Scissor	67
Baumgartner Wire Twisting Forcep	512
Battery Operated Drill	491
Battery Operated Sagittal Saw	494
Battery Operated Sternum Saw	494
Bechert Lens Holding Forcep	205
Beckmann Self Retaining Retractor	343
Beckmann-Adson Self Retaining Retractor	344-345
Beckmann-Eaton Self Retaining Retractor	346
Bed Pan	655
Beebee Crown Scissor	90-91
Beer Cilia Forcep	186
Beeson Plaster Spreader	486
Bengolea Haemostatic Forcep	246
Bennett Bone Lever	571
Benson Pylorus Spreader	614
Bergh Cilia Forcep	186
Bergmann	
Bandage Scissor	94
Bone Mallet	538
Operating Knife	16
Sponge Holding Forcep	285
Berke Ptosis Forcep	207
Berkeley-Bonney Hysterectomy Forcep	270
Bernhard Towel Clamp	276



## Alphabetical Index

### B

	Page
Berry Wire Twisting Forcep	512
Beyer Bone Rongeur	590
Biemer	
Clip Applying Forcep	216
Vein Scissor	107
Vessel Clip	216
Biemer-Mueller Nerve Approximator	217
Bier Amputation Saw	490
Bier Saw Blade	490
Bircher-Ganske Bone Holding Forcep	582
Birkett Haemostatic Forcep	245
Bishop-Harmon	
Dressing Forcep	195
Iris Forcep	194
Blaydes Lens Holding Forcep	206
Blond Proctoscope	623-625
Blount Knee Retractor	573
Blue Rectal Aspiration Cannula	630
Blumenthal Bone Rongeur	588-589
Bohler	
Bone Cutting Forcep	595
Bone Rongeur	590
Extension Bows	505
Boley Caliper	396
Bonaccolto Conjunctival Forcep	201
Bone Chisel	518, 520, 530
Bone Curette	549-550
Bone File	535
Bone Gouge	520, 531, 532
Bone Holding Forcep	580-581, 585
Bone Lever	566-567, 570
Bone Mallet	538, 540-542
Bone Osteotome	519
Bone Reamer	494-495
Bone Repositioning Forcep	579-581
Bone Tamper	536
Bonn	
Corneal Forcep	192
Iris Scissor	78-79
Bonner-Modell Dissecting Forcep	156
Bonney	
Dissecting Forcep	162, 210
Dressing Forcep	148
Borchardt Burr	503
Borchardt Flat Trephine	500
Borchardt Twist Drill	499-503

### B

	Page
Bose Fat Spreader	331
Botvin Iris Forcep	189
Bowel Dissecting Scissor	88
Bowl	648-649, 651
Bowman Probe	381
Boys-Allis Intestinal & Tissue Grasping Forcep	607
Bozemann	
Gynecological Scissor	39
Knot Tier	481
Needle Holder	461
Sponge Holding Forcep	284-285
Bozemann-Douglas Sponge Holding Forcep	285
Brand Tendon Tunnelling Forcep	577
Braun-Stadler Episiotomy Scissor	73
Bridge Haemostatic Forcep	248
Bristow Bone Lever	572
Brodie Butterfly Probe	380
Brom Vein Hook	300
Brompton Tube Milking Roller	278
Brophy	
Dissecting Forcep	156
Dressing Forcep	147
Brown Needle Holder	430
Brunetti Post Mortem Chisel	518
Brunner	
Intestinal Clamp	613, 617
Ligature Conductor	479
Ligature Needle	478
Retractor	314
Bruns	
Bone Curettes	544, 545
Plaster of Paris Shear	96
Bryant Dressing Forcep	281
Buchs	
Periosteal Elevator	556
Retractor	312
Buck	
Percussion Hammer	388
Stitch Scissor	89
Buckley Wound Spreader	332
Bunnell	
Hand Drill	504
Tendon Passer	577
Tendon Stripper	575
Buratto	
IOL Inserting Forcep	205



## Alphabetical Index

### B

	Page
Buratto	
LASIK Flap Forcep	197
Burke Hysterectomy Forcep	271
Busch Umbilical Cord Scissor	74
Butterfly Probe	380
Byrd Suction Tube	410

### C

Cairns Haemostatic Forcep	241-242
Caplan Septum Scissor	70
Carrel Haemostatic Forcep	228
Carroll	
Finger Goniometer	394
Tendon Tunnelling Forcep	578
Caspar	
Bone Curette	546
Bone Tamper	536
Ligature Adjuster	481
Periosteal Elevator	555
Retractor	313, 372-374
Scalpel Handle	9
Castroviejo	
Blade Breaker	25
Caliper	396-397
Corneoscleral Scissor	99
Keratoplasty Scissor	101
Micro Needle Holder	436-440, 447-449, 454-457
Suture Tying Forcep	193-194
Universal Corneal Scissor	101
Castroviejo-Colibri Corneal Forcep	191
Castroviejo-Epker Corneal Forcep	396
Catheter Introducer	643
Catlin Amputation Knife	20
Cawthorne Probe	378
Chadwick Delicate Scissor	84
Chandler Bone Lever	572
Chaput Haemostatic Forcep	225
Charnley	
Dissecting Forcep	165
Retractor	364
Charriere Amputation Saw	490-491
Charriere Saw Blade	490
Cheron Dressing Forcep	284

### C

	Page
Childe Approximation Forcep	482
Cinelli Nasal Scissor	49
Clar Head Light	391
Claus Van Eicken Ligature Needle	471
Clayman Lens Holding Forcep	206
Cleveland	
Bone Cutting Forcep	595
Bone Rongeur	587
Clip Applying Forcep	219
Cloward	
Bone Gouge	528
Bone Osteotome	527
Lamina Spreader	374-375
Retractor	367-368
Cobb	
Bone Curette	547
Bone Gouge	531-532
Periosteal Elevator	563
Cogswell Suction Tube	410
Colibri Corneal Forcep	190
Coller Haemostatic Forcep	239
Collier Needle Holder	428
Collin	
Bone Mallet	537
Clip Applying Forcep	483
Dressing Forcep	284
Dynamometer	395
Organ Grasping Forcep	226
Scalpel Handle	4
Self-Retaining Retractor	348-352
Tumor Grasping Forcep	226
Collin-Baby Self-Retaining Retractor	348
Collin-Duval Intestinal Forcep	163
Collin-Hartmann Retractor	327
Collingwood-Stewart Hernia Ring Forcep	646
Combi Wire Twisting & Cutting Forcep	512-515
Conical Burr	497, 501-502
Converse	
Alar Hook	293
Nasal Scissor	72
Needle Holder	428, 459
Converse (Graefe) Nasal Scissor	72
Cooley	
Atrauma Dissecting Forcep	183
Dressing Forcep	148
Retractor	323



## Alphabetical Index

### C

	Page
Cooley	
Suction Tube	407-408
Vascular Scissor	67
Cooper Ligature Needle	472
Corwin Wire Twisting Forcep	512
Coryllos Retractor	314
Cottle	
Alar Hook	294
Bone Mallet	538
Bulldog Scissor	83
Lid Retractor	296
Nasal Hook	290
Nasal Scissor	71, 133
Periosteal Elevator	554
Cottle-Kazanjian Bone Cutting Forcep	594
Cottle-Masing Plastic Surgery Scissor	49
Cotton Applicator	385
Coupland Suction Tube	409
Crafoord Haemostatic Forcep	247
Crafoord-Sellors Haemostatic Forcep	248
Cranny-Ryall Retractor	330
Crile	
Haemostatic Forcep	233-234
Needle Holder	435
Nerve Hook	291
Crile-Murray Needle Holder	430
Crile-Rankin Haemostatic Forcep	234
Crile-Wood Needle Holder	430, 458, 460
Cushing	
Dissecting Forcep	156
Dressing Forcep	146, 212
Flat Trephine	497
Nerve Hook	291
Periosteal Elevator	557
Retractor	299-300
Cushing-Kocher Retractor	310
Cushing-Taylor Dressing Forcep	212
Czerny	
Rectal Speculum	618
Retractor	329

### D

	Page
Dahmen	
Bone Gouge	534
Bone Osteotome	533
Dandy Haemostatic Forcep	241
Dandy-Mosquito Haemostatic Forcep	241
Daubenspeck Bone Curette	548
Davidson Scapula Retractor	314
De Martel-Wolfson Clamp Holder	614
De Martel-Wolfson Closing Forcep	614
De Martel-Wolfson Intestinal Clamp	614
Dean Tonsil Scissor	70, 140
Deaver	
Operating Scissor	31
Retractor	320-322
DeBakey	
Arteriotomy Scissor	59
Atrauma Dissecting Forcep	181-183, 213-214
Needle Holder	454, 462
Offset Scissor	66
Suction Tube	408
Vascular Scissor	60, 138
DeBakey-Diethrich Atrauma Bulldog Clamp	222
DeBakey-Hess Atrauma Bulldog Clamp	223
Deep Saw Blade	488
Dejerine Percussion Hammer	388
Delicate Gum Scissor	77
Delicate Scissor	84
Demel	
Wire Guide	504
Wire Tightener	505
Dennis-Browne	
Intestinal Forcep	163
Retractor	366-367
Denture Cup	654
Derf Needle Holder	428, 458
Dermal Punch	602
Dermatoscope	394
Deschamps Ligature Needle	472-477
Desjardins	
Bile Duct Clamp	264
Gall Stone Forcep	639
Desmarres	
Chalazion Forcep	209
Entropian Forcep	209
Lid Retractor	296
Dick Atrauma Vaginal Clamp	267





## Alphabetical Index

### D

	Page
Dieffenbach	
Bulldog Clamp	220
Operating Knife	14-16
Diethrich	
Bulldog Clamp	221
Micro Needle Holder	457
Vascular Scissor	60
Diethrich-Potts Vascular Scissor	63-65
Diethrich-Salyer Cleft Palate Scissor	60
Dingmann Cartilage Seizing Forcep	582
Diplomat Manometer	390
Dissecting & Ligature Forcep	250
Dissecting Forcep	155, 157
Dissecting Hook	311
Dissecting Scissor	57
Dockhorn Retractor	313
Dodick	
IOL Folding Forcep	204
Nucleus Cracker	203
Douglas Cilia Forcep	186
Downes Lid Clamp	208
Doyen	
Bone Mallet	537
Butterfly Probe	380
Conical Burr	502
Cylindrical Burr	502
Gynecological Scissor	37
Intestinal Clamp	610, 615-616
Needle Holder	429
Retractor	317
Rib Raspatory	562
Spherical Burr	501-502
Towel Clamp	274
Doyen-Baby Intestinal Clamp	609, 615
Doyen-Stille Retractor	318
Dressing Forcep	147-148
Dressing Jar	653
Drill Handle	495
Dunhill Haemostatic Forcep	240, 242
Duplay Sponge Holding Forcep	283
Duplex Stethoscope	390
Duplex-Baby Stethoscope	389
Durante Dissecting Forcep	162
Durham Retractor	312
Duval Intestinal & Tissue Grasping Forcep	163, 609

### E

	Page
Echlin Bone Rongeur	592
EENT Diagnostic Set	393
Eiselberg Stitch Scissor	90
Elsaesser Nephrectomy Forcep	637
Elschnig Fixation Forcep	195
Emmet Dressing Forcep	284
Engel Plaster Saw	486
Enterotomy Scissor	87-88
Enucleation Scissor	83
Erhardt Lid Forcep	208
Ernest Nucleus Cracker	203
Esmarch	
Bandage Scissor	95
Plaster of Paris Shear	485
Extension Bows	506

### F

Farabeuf	
Bone Holding Forcep	584
Periosteal Elevator	558
Retractor	328
Farrell Cotton Applicator	384
Fat Spreader	332
Faulkner Lens Holding Forcep	205
Faure Peritoneum Forcep	274
Favaloro Offset Scissor	66
Fechtner Conjunctival Forcep	191
Fehland Sigmoid Anastomosis Clamp	618
Feilchenfeld Splinter Forcep	185
Feldheim Tourniquet	597
Female Catheter	643
Female Urinal	656
Fergusson	
Angiotribe	272
Bone Holding Forcep	581
Suction Tube	401
Ferris-Smith Dissecting Forcep	162, 213
Fickling Haemostatic Forcep	244-245
Filiform Urethral Sound	644
Fine	
Dissecting Forcep	150
Dressing Forcep	143
Micro Scissor	103



## Alphabetical Index

### F

	Page
Fine	
Operating Scissor	76
Suture Tying Forcep	200
Stitch Scissor	103
Finger Ring Saw	598
Finochietto	
Dissecting & Ligature Forcep	262
Needle Holder	433, 462
Finsen Wound Spreader	330-331
Finsen-Martin Wound Spreader	331
Finsterer Suction Tube	408
Fischer Tendon Stripper	576
Flat Burr	503
Flat Nose Plier	513-515
Foerster Sponge Holding Forcep	286-287
Fomon Nasal Scissor	50, 71, 133
Ford Dixon Hemorrhoidal Ligator	631
Foreign Body Forcep	202
Foster-Gillies Needle Holder	465
Fowler Tonsil Knife	22
Fox Lupus Curette	601
Francis Chalazion Forcep	209
Fraser-Kelly Haemostatic Forcep	239
Frazier	
Delicate Hook	289
Suction Tube	401
Freeman-Kaye Facelift Scissor	135
Freer Mucus Hook	293
Friedmann	
Bone Rongeur	586-587
Retractor	346
Fritsch Retractor	318
Frosch Bone Holding Forcep	583
Frykholm Bone Rongeur	593

### G

Gardner Bone Chisel	519
Gelpi Self Retaining Retractor	347
Gemini Dissecting & Ligature Forcep	257
Gemini, Mini Dissecting & Ligature Forcep	257
Gerald	
Dissecting Forcep	155, 210
Dressing Forcep	146

### G

	Page
Gerald	
Micro Forcep	180
Micro Ring Forcep	180
Micro Suturing Forcep	181
Gerald-DeBakey Micro Atrauma Forcep	180
Gerl Suture Tying Forcep	200-201
Gerster Traction Bar	511
Gerster-Lowman Bone Holding Clamp	511
Gerzog Bone Mallet	537
Gil-Vernet Retractor	300
Gillies	
Dissecting Forcep	154, 210
Dressing Forcep	147
Needle Holder	434, 465
Skin Hook	289
Gillies-Mini Needle Holder	465
Gills Capsulotomy Scissor	106
Gills-Colibri Corneal Forcep	189
Gills-Vannas	
Capsulotomy Scissor	104
Micro Scissor	105
Girard Corneoscleral Forcep	194
Glover, Mini Bulldog Clamp	223-224
Goelet Retractor	330
Gold Punctal Plug Forcep	202
Goldman-Fox Gum Scissor	74-75, 137
Goligher Retractor	363
Gomco Circumcision Clamp	645
Good Tonsil Scissor	71
Gorney Facelift Scissor	48, 134-135
Gosset Retractor	359
Gosset-Baby Retractor	358
Gradle Cilia Forcep	201
Graduated Measure	649-650
Graduated Triangular Basin	656
Graefe	
Delicate Hook	289
Eye Dissecting Forcep	188-189
Eye Dressing Forcep	188
Fixation Forcep	195
Nerve Hook	291
Gray Dissecting & Ligature Forcep	265
Greene Retractor	312
Gregory Facelift Scissor	134
Grey-Turner Haemostatic Forcep	241
Gross-Maier Sponge Holding Forcep	282-283



## Alphabetical Index

### G

	Page
Guthrie Skin Retractor	292
Guyon	
Kidney Pedicle Clamp	263-264
Urethral Sound	642-643
Gwilliam Hysterectomy Forcep	270

### H

Haberer Intestinal Clamp	613
Haemostatic Forcep	228
Hajek	
Bone Mallet	537
Retractor	329
Halle Bone Curette	548
Halsey Needle Holder	428-429, 459
Halsted-Mosquito Haemostatic Forcep	228-231
Hand Immobilizer	597
Harms Suture Tying Forcep	200
Harms-Colibri Corneal Forcep	190-191
Harrington Retractor	320
Harris Chuck	492
Hartmann	
Bone Rongeur	588
Cotton Applicator	385
Haemostatic Forcep	227-228
Harvey Wire Cutting Scissor	90
Harvey-Jackson Self Retaining Retractor	344
Hatfield Bone Curette	547
Hayes Sigmoid Anastomosis Clamp	617
Head Light	392
Heaney	
Hysterectomy Forcep	266-268
Needle Holder	432, 461
Heaney (Rogers) Hysterectomy Forcep	268
Heaney-Ballentine Hysterectomy Forcep	266
Heaney-Razek Hysterectomy Forcep	266
Heath Bone Mallet	539
Heberer Abdominal Spatula	326
Hegar Needle Holder	460
Hegar-Baumgartner Needle Holder	429, 459
Hegar-Vascular Needle Holder	464
Hegenbarth Clip Applying Forcep	482
Heifetz Tumor Grasping Forcep	166
Heiming Kidney Stone Forcep	637

### H

	Page
Heiss Haemostatic Forcep	249
Helveston Suture Tying Forcep	200
Hemingway Bone Curette	550-551
Henley Retractor	354
Hennig Plaster Spreader	486
Hepp-Scheidel Micro Needle Holder	454, 457
Herbert Bone Mallet	542
Herrick Kidney Pedicle Clamp	264
Heygroves Bone Holding Forcep	583
Heymann Nasal Scissor	72
Heywood-Smith Sponge Holding Forcep	285
Hibbs	
Bone Chisel	526
Bone Gouge	527
Bone Osteotome	526
Knee Retractor	574
Hirschman Anoscope	621
Hoer Periosteal Elevator	557
Hoesel	
Retractor	319
Needle Holder	435
Hoffer-McPherson Tissue Forcep	193
Hoffmann Tubing Clamp	279
Hohmann Bone Lever	567-569
Hohmann-Aldinger Bone Lever	570
Hohmann-Mini Bone Lever	566
Hoke Osteotome	526
Holzbach Hysterectomy Forcep	269
Hopkins Plaster Knife	485
Hoskins Tissue Forcep	191
House Suction Tube	403-404
Hudson	
Chuck	492
Hand Drill	497
Humby Skin Graft Knife	23
Hunt	
Chalazion Forcep	208
Tumor Grasping Forcep	166
Hunter Splinter Forcep	185
Hurd Ligature Needle	477
Hypodermic Needle	410
Hypodermic Syringe	414



## Alphabetical Index

### I

	Page
Ideal Finger Nail Drill	597
Incision Scissor	30
Inge Lamina Spreader	375
Instrument Box	652-653
Instrument Tray	650-651
Interosseous Knife	20
Iris	
Micro Scissor	103
Scissor	78-80, 137-139
Israel Retractor	306
Ives-Fansler Anoscope	622
Iwanson Clipper	397

### J

Jaboma Micro Scissor	121-122
Jackson-Burrows	
Dissecting Forcep	165
Self-Retaining Retractor	348
Jacobs Chuck	491, 499
Jacobson	
Haemostatic Forcep	240
Micro Needle Holder	438, 456
Micro Scissor	108, 119
Jaffe	
Capsulorhexis Forcep	198
Stitch Scissor	102
Suture Tying Forcep	198-199
Utility Forcep	202
Jameson	
Caliper	394
Dissecting Scissor	58
Muscle Forcep	206-207
Needle Holder	432
Jameson-Werber Dissecting Scissor	58
Janet Syringe	414
Jansen	
Bone Curette	550
Bone Rongeur	588
Periosteal Elevator	556
Self-Retaining Retractor	333
Jefferson Self-Retaining Retractor	340
Jeweller Forcep	157-159
Jobson-Horne Ear Probe	385

### J

	Page
John-Hopkins Bulldog Clamp	221
John-Hopkins Clip Applying Forcep	221
Johnson Needle Holder	433
Joll (Friedman) Self-Retaining Retractor	346
Jones Towel Clamp	274
Jonesco Ligature Needle	471
Joseph	
Dissecting Scissor	40-41, 129
Mucus Hook	290, 293
Judd-Allis Intestinal & Tissue Grasping Forcep	607
Judd-Masson Retractor	356

### K

Kader Abdominal Retractor	325
Kahre-Williger Periosteal Elevator	561
Kalt Micro Needle Holder	439
Kantrowitz Dissecting & Ligature Forcep	261
Karp Aorta Punch	25
Katsch Comedone Extractor	603
Katzin Corneal Transplant Scissor	100
Kaye	
Facelift Hook	602
Facelift Scissor	47, 134
Scalpel Handle	5
Kaye-Millard Retractor	301
Kelly	
Dissecting & Ligature Forcep	255-256
Dissecting Scissor	39-40, 139
Haemostatic Forcep	232-233
Proctoscope	622
Retractor	316, 324
Sphincteroscope	625
Kelly-Rankin Haemostatic Forcep	233
Kelman-McPherson	
Tissue Forcep	193
Suture Tying Forcep	197
Kern Bone Holding	583
Kerpel Bone Curette	551
Key Periosteal Elevator	556
Keyes Dermal Punch	602
Kidney Dish	655
Kieback	
Dissecting & Ligature Forcep	258



## Alphabetical Index

### K

	Page
Kieback	
Hysterectomy Forcep	270
Parametrium Scissor	39
Killian	
Bone Shear	69
Probe	379
Kilner	
Alar Hook	293
Dissecting Scissor	56, 83, 139
Needle Holder	429, 458
Skin Hook	289
Kirsch Retractor	310
Kirschner	
Extension Bows	506
Ligature Conductor	479
Ligature Needle	478
Retractor	365-366
Wire Drill	507-510
Klapp Retractor	301
Kleinert-Kutz	
Delicate Hook	289
Tendon Holding Forcep	578
Klinikum Berlin Tubing Clamp	277
Klinkenberg-Loth Vascular Scissor	68
Knapp Fine Wound Retractor	292
Knowles Bandage Scissor	93
Knutson Urethrography Instrument	644
Kocher	
Haemostatic Forcep	236-237
Intestinal Clamp	611, 616-617
Ligature Needle	472
Retractor	304, 308, 311, 318
Kocher-Baby Intestinal Clamp	610-611
Kocher-Langenbeck Retractor	309
Kocher-Nippon Haemostatic Forcep	237-238
Kocher Delicate Haemostatic Forcep	238-239
Koenig	
Ligature Conductor	480
Periosteal Elevator	552
Retractor	310
Koerte Retractor	305-306, 323
Korenlein Haemostatic Forcep	225
Kraemer	
Periosteal Elevator	555-556
Retractor	313
Kraff Capsule Tag Forcep	198

### K

	Page
Kratz Lens Holding Forcep	206
Kronecker Ligature Needle	472
Kummel	
Abdominal Spatula	324
Retractor	323
Kurstin Flap Stretching Forcep	197

### L

La Grange Gum Scissor	76
Lagueu Retractor	356
Lahey	
Bile Duct Clamp	262
Dissecting & Ligature Forcep	261
Retractor	308
Lahey (Sweet) Bile Duct Clamp	262
Lambert Chalazion Forcep	208
Lambotte	
Bone Holding Forcep	584
Bone Osteotome	523
Periosteal Elevator	563
Lambotte-Mini Bone Osteotome	522-523
Landolt	
Dissecting Suction Tube	405
Periosteal Elevator	555
Scalpel Handle	9-10
Lane	
Bone Holding Forcep	585
Bone Lever	572
Dissecting Forcep	164
Intestinal Clamp	612-613
Retractor	329
Towel Clamp	277
Lane-Terthowan Bone Lever	572
Lange-Hohmann Bone Lever	569
Langenbeck	
Amputation Saw	490
Bone Holding Forcep	581
Flap Knife	20
Needle Holder	435, 467
Periosteal Elevator	557-558, 564
Resection Knife	21
Retractor	307-308
Langenbeck-Green Retractor	297



## Alphabetical Index

### L

	Page
Langenbeck-Mini Retractor	297
Lawrence	
Dissecting & Ligature Forcep	256
Needle Holder	430
Lazar Micro Suturing Forcep	167
Leksell-Stille Bone Rongeur	592
Lempert Bone Rongeur	588
Lerche Dissecting Forcep	152
Leriche	
Haemostatic Forcep	232
Retractor	322
Lewin Bone Repositioning Forcep	580
Lexer	
Dissecting Scissor	48-49, 129-130
Bone Chisel	529-530
Bone Gouge	528, 530
Bone Osteotome	529-530
Lexer-Baby Dissecting Scissor	50
Lexer-Fine Dissecting Scissor	50-51
Lexer-Mini	
Bone Gouge	529
Bone Osteotome	528
Lichtenberg Needle Holder	434, 466
Lichtwitz Antrum Puncture Needle	412
Lid Retractor	296
Ligature Adjuster	481
Ligature Conductor	479
Ligature Needle	471, 478
Lister	
Bandage Scissor	94, 140
Sinus Forcep	281
Lister (Eccentric) Bandage Scissor	94
Liston	
Amputation Knife	19
Bone Cutting Forcep	594
Liston-Key Bone Cutting Forcep	596
Littauer	
Cilia Forcep	186
Stitch Scissor	90
Little Retractor	308
Littler Dissecting Scissor	83
Littlewood Intestinal & Tissue Grasping Forcep	608
Livernois	
IOL Folding Forcep	204
IOL Holding Forcep	204-205
Livernois-McDonald IOL Inserting Forcep	205

### L

	Page
Lloyd-Davies (Goligher) Rectal Scissor	88
Lockhart-Mummery Fistula Probe	381-382
Locklin Gum Scissor	77, 140
Lockwood Intestinal & Tissue Grasping Forcep	607
Logan Wound Spreader	331
Lorenz Bandage Scissor	93
Lorna Towel Clamp	276
Loute Wire Tightener	505
Lovelace Haemostatic Forcep	242
Lucae Bone Mallet	538
Lucas Bone Curette	551
Luer Bone Rongeur	589
Luer Suction Tube	404
Luer-Koerte Gall Stone Scoop	640

### M

M.G. Hospital Needle Holder	431
Magill Catheter Introducing Forcep	418
Magnifying Glass	392
Maingot Hysterectomy Forcep	265
Male Urinal	656
Malleolar Forcep	580
Manhattan Eye & Ear Fixation Forcep	195
Manometer	390
Marquard Bone Rongeur	591
Martel-Rees Facelift Forcep	227
Martin	
Abdominal Spatula	326
Cartilage Seizing Forcep	583
Dressing Forcep	281-282
Finger Ring Saw	598
Hand Drill	498
Ligature Needle	478
Needle Holder	463
Plaster Knife	485
Retractor	313
Self-Retaining Retractor	346
Martin-Cushing Periosteal Elevator	557
Martin-Fuchsig Haemostatic Forcep	243
Martin-Jones Towel Clamp	275
Martin-Langenbeck Periosteal Elevator	564
Martini Needle Holder	464



## Alphabetical Index

### M

	Page
Masing	
Cartilage Slitting Knife	22
Lid Retractor	296
Masson Needle Holder	432, 461
Masson-Luethy Needle Holder	432
Mathieu	
Foreign Body Forcep	645
Needle Holder	434, 465-466
Rectal Speculum	620
Retractor	329
Mayfield Bone Rongeur	590
Mayo	
Common Duct Probe	379
Dissecting Scissor	31-32, 124-125
Mayo (Russian) Dissecting Forcep	162
Mayo-Bakes Gall Stone Forcep	638-639
Mayo-Harrington Dissecting Scissor	33
Mayo-Hegar Needle Holder	431, 460
Mayo-Lexer Dissecting Scissor	130
Mayo-Noble Dissecting Scissor	35-36
Mayo-Robson Intestinal Clamp	610, 616
Mayo-Stille Dissecting Scissor	34-35, 125-126
McDonald Periosteal Elevator	565
McGiveny Hemorrhoidal Ligator	630-631
McIndoe	
Cartilage Scissor	47
Dissecting Forcep	156
Dressing Forcep	144, 210
Wound Retractor	293
McIntosh Laryngoscope	419-421, 424
McIntosh-Baby Laryngoscope	419
McKenzie Burr	498
McKissock Periosteal Elevator	555
McPherson	
Micro Needle Holder	435-436
Suture Tying Forcep	192, 196
McPherson-Vannas Iris Scissor	105
McPherson-Westcott	
Conjunctival Scissor	101
Stitch Scissor	102
McQuigg-Mixter Dissecting & Ligature Forcep	260
Mead	
Bone Mallet	539
Bone Rongeur	587
Periosteal Elevator	553
Measuring Caliper	396

### M

	Page
Measuring Tape	397
Medicine Cup	654
Medicine Spoon	654
Meeker Dissecting & Ligature Forcep	256
Mendez Multipurpose LASIK Forcep	197
Menghini Liver Puncture Needle	412
Meniscus Knife	574
Metal Cup	654
Metal Jar	652
Methot Cotton Dispenser	657
Metzenbaum	
Dissecting Scissor	41-44, 46, 126-128
Needle Holder	431
Nerve Dissecting Scissor	47
Metzenbaum-Thorek Dissecting Scissor	128
Metzenbaum-Fine Delicate Dissecting Scissor	51-54, 130-133
Metzenbaum-Lahey Dissecting Forcep	132-133
Metzenbaum-Nelson Dissecting Scissor	45-46
Meyerdig Retractor	298, 317
Michel Clip Applying & Removing Forcep	482-483
Michel Clip Applying Forcep	482
Michel Suture Clips	483
Micro Atrauma Forcep	174, 179-180
Micro Coronary Scissor	111-113, 115-116
Micro Dissecting Forcep	171-172
Micro Dissecting Scissor	108
Micro Dressing Forcep	169-170, 181
Micro Elevator	564
Micro Mosquito Haemostatic Forcep	229-230
Micro Needle Holder	438, 440-441, 445-447, 449-453, 456
Micro Pierce Forcep	160-161, 175-177
Micro Ring Forcep	173, 175, 177-179
Micro Scalpel Blade	10-11
Micro Scissor	98, 107-109, 114, 117-121
Micro Suturing Forcep	168-169, 174-176, 178 -179
Micro Vascular Needle Holder	464
Micro Vessel Dilator	160-161, 175-177
Middeldorf Retractor	312
Mikulicz	
Peritoneum Forcep	273
Retractor	324
Mikulicz-Baby Peritoneum Forcep	272
Miller Laryngoscope	418-419, 422, 425
Millesi Micro Scissor	110
Milligan Self-Retaining Retractor	342



## Alphabetical Index

### M

	Page
Millin	
Capsule Forcep	641
Ligature Holding Forcep	481
Retractor	355-356
Mixing Bowl	649
Mixer	
Dissecting & Ligature Forcep	259
Gall Stone Forcep	639
Mixer-Baby Dissecting & Ligature Forcep	258-259
Mixer-O'Shaughnessy Dissecting & Ligature Forcep	260
Mock Heparin Flushing Needle	414
Modell Wien Ligature Catcher	481
Modell. USA	
Bone Curette	547-548
Dissecting Forcep	151
Dressing Forcep	143
Umbilical Cord Scissor	73
Moeltgen Flexometer	395
Mogen Circumcision Clamp	645
Mohr Pinchcocks	279
Moldestad Vessel Hook	295
Mollison Self-Retaining Retractor	340-341
Molt Bone Curette	552-553
Molt Periosteal Elevator	553
Monocorps Miliium Knife	601
Moore Hand Drill	498
Moorfield Conjunctival Forcep	201
Morgan Proctoscope	625
Morris Retractor	316
Moynihan Hysterectomy Forcep	271
Muehling Bone Shear	70
Mueller	
Nerve Approximator	218
Rectal Scissor	89
Murphy Retractor	305
Murphy-Lane Bone Lever	571
Myrtle Leaf Probe	378

### N

Nabatoff Vein Probe	382-383
Nail Scissor	91-92
Naunton-Morgan Needle Holder	462
Needle Holder	462

### N

	Page
Neff Meniscus Knife	575
Negus Haemostatic Forcep	243-244
Neivert Needle Holder	429
Nelaton Butterfly Probe	380
Nelson	
Dissecting Forcep	163
Trocar	399
Nerve Approximator	218-219
Nerve Dissecting Scissor	57, 84
Nissen	
Bile Duct Clamp	264
Haemostatic Forcep	243
Non Perforating Towel Clamp	276
Norfolk-Norwich Self-Retaining Retractor	335
Northbent Stitch Scissor	89
Norwood Rectal Snare	629
Noyes Iris Scissor	97-98
Nuboer Suction Tube	409
Nugent Utility Forcep	201-202
Nussbaum Intestinal Clamp	612

### O

O'Connell Periosteal Elevator	566
O'Connor Skin Hook	290
O'Sullivan-O'Connor Retractor	364
Ochsner	
Dressing Forcep	148
Gall Stone Probe	379
Trocar	399
Ochsner-Kocher Haemostatic Forcep	235-236
Oehler Dissecting Forcep	213
Olivecrona	
Trigeminal Knife	21
Trigeminal Scissor	68
Ollier Retractor	305
Olsen-Hegar Needle Holder	433, 465
Omberdanne Bone Mallet	539
Operating	
Knife	16-18
Loupe	392
Scissor	27-30, 123-124
Ophthalmoscope	393-394
Organ Grasping Forcep	226





## Alphabetical Index

### O

	Page
Oscillating Sagittal Saw	493
Osher Iris Forcep	202
Otis Urethrotome	644
Otoscope	393-394
Overholt Dissecting & Ligature Forcep	254
Overholt-Baby Dissecting & Ligature Forcep	251
Overholt-Fine Dissecting & Ligature Forcep	254
Overholt-Geissendoerfer Dissecting & Ligature Forcep	252-253
Overholt-Martin Dissecting & Ligature Forcep	250
Overholt-Mini Dissecting & Ligature Forcep	255
Overholt-Mixer Dissecting & Ligature Forcep	251

### P

Parametrium Hysterectomy Scissor	136
Parker Retractor	328
Parker-Langenbeck (US Army) Retractor	329
Parker-Mott Retractor	328
Parks Rectal Speculum	620
Partsch	
Bone Chisel	520-521
Bone Gouge	521
Bone Mallet	540
Periosteal Elevator	552
Partsch Mod. Lange	552
Passow Bone Tamper	536
Patella Forcep	580
Payr	
Intestinal Clamp	612
Ligature Conductor	480
Payr-Baby Intestinal Clamp	611
Pean Delicate Haemostatic Forcep	238
Pean Haemostatic Forcep	224
Pean-Nippon Haemostatic Forcep	237
Peck-Joseph Facelift Scissor	55-56
Peers-Bretram Towel Clamp	277
Peet Splinter Forcep	187
Pelkmann Foreign Body Forcep	283
Pennington Organ Grasping Forcep	226
Pennybaker Periosteal Elevator	556, 566
Percy Amputation Shield	586
Periosteal Elevator	559-562
Perkins Self-Retaining Retractor	339-340
Perthes Bone Reamer	494

### N

	Page
Phalangeal Knife	20
Phaneuf Hysterectomy Forcep	265
Pierce-Colibri Corneal Forcep	190
Pinard Stethoscope	389
Placenta Pan	656
Plaster of Paris Shear	96
Plaster Saw	487
Plester Self-Retaining Retractor	341-342
Polloson Retractor	319
Poole Suction Tube	407
Poole-Baby Suction Tube	407
Post Mortem Chisel	518
Post Mortem Hammer	518
Potts	
Dissecting Scissor	59
Micro Scissor	120
Potts-De Martel Vascular Scissor	66
Potts-Smith	
Dissecting Forcep	156
Dressing Forcep	146, 212
Vascular Scissor	60-62, 67
Pratt	
Fistula Probe	382
Haemostatic Forcep	227
Rectal Speculum	618
Presbyterian Tubing Clamp	278
Pressofix Tourniquet	391
Prince Tonsil Scissor	70
Proctoscope	623
Probe	377-379
Prostate Retractor	326
Providence-Hospital Haemostatic Forcep	231
Pudendus Anaesthesia Needle	411
Putti Bone Rasp	534-535

### Q

Quattro (Mod. USA) Plaster Spreader	486
Quimby Delicate Scissor	84
Quinke Lumbar Puncture Needle	411



## Alphabetical Index

### R

	Page
Rabiner Percussion Hammer	389
Rachietome	518
Radolf Nail Extracting Forcep	599
Ragnell (Kilner) Dissecting Scissor	56, 139
Ragnell-Davis Retractor	298
Ralk	
Hand Drill	504
Splinter Forcep	187-188
Rampley Sponge Holding Forcep	287
Ramsey	
Dissecting Forcep	164
Dressing Forcep	148
Randall Kidney Stone Forcep	635-636
Razor Knife	22-23
Record-Arkansas Sharpening Stone	23
Rectal Scissor	88
Recto-Proctoscope	626-629
Rectoscope	626
Redon Guide Needle	415-416
Rees Facelift Scissor	134
Reill	
Bone Repositioning Forcep	579
Micro Needle Holder	445
Reiner Plaster Knife	485
Resano	
Cartilage Scissor	41
Sigmoid Anastomosis Clamp	618
Resection Knife	20
Reverdin	
Abdominal Spatula	325
Ligature Needle	467-469
Reynolds Dissecting Scissor	57-58
Ribbon	
Grade Scissor	87
Iris Scissor	85
Kaye Facelift Scissor	87
Salyer Scissor	85
Stevens Tenotomy Scissor	86-87
Strabismus Scissor	86
Ricard Retractor	352-353
Richardson Retractor	315
Richardson-Eastman Retractor	315
Richter Clip Applying Forcep	483
Roberts	
Haemostatic Forcep	247
Periosteal Elevator	554

### R

	Page
Robin Towel Clamp	275
Rochester-Carmalt Haemostatic Forcep	244
Rochester-Ochsner Haemostatic Forcep	236
Rochester-Pean Haemostatic Forcep	235
Roeder Towel Clamp	276
Roettgen-Ruskin Bone Rongeur	592
Rollet Fine Wound Retractor	292
Roschke Anal Retractor	621
Rosenwasser Donor Lamella Inserting Forcep	204
Ross Aorta Retractor	319
Round Bowl	648, 651
Round Dish	649
Round Saw Blade	487
Roux Retractor	327-328
Roux-Baby Retractor	327
Roux-Mini Retractor	327
Rudd Hemorrhoidal Ligator	630
Ruler	397
Rumel Dissecting and Ligature Forcep	257
Ruskin Bone Rongeur	591
Ruskin-Liston Bone Cutting Forcep	595-596
Russian Modell Dissecting Forcep	161
Ryder Needle Holder	463
Ryder-Vascular Needle Holder	454, 463

### S

Saalfeld Comedone Extractor	603
Sachse Meatotome	645
Salyer	
Bone Holding Forcep	582
Cleft Palate Scissor	54
Samii Tumor Grasping Forcep	165
Sanvenero Dissecting Scissor	55
Sarot	
Haemostatic Forcep	247
Needle Holder	432, 460
Satinsky Thoracic Scissor	59
Satterlee Amputation Saw	491
Satterlee Saw Blade	491
Sauer Fixation Forcep	195
Sauerbruch	
Bone Rongeur	594
Retractor	309, 315



## Alphabetical Index

### S

	Page
Scalp-Contour Self-Retaining Retractor	333-334
Scalpel Blade	5-8
Scalpel Handle	2-4, 9
Scalpel Blade Remover	8
Schaedel Towel Clamp	274
Schamberg Comedone Extractor	603
Schede Bone Curette	543
Scheibe (Collin) Organ Grasping Forcep	615
Schink Skin Graft Knife	24
Schink Skin Graft Knife Blade	24
Schmid Vessel Irrigation Cannula	414
Schmieden	
Ligature Conductor	479
Ligature Needle	470
Schmieden-Dick Ligature Needle	470
Schmieden-Payr Ligature Conductor	480
Schmieden-Taylor Dissecting Scissor	68
Schmidt Haemostatic Forcep	243
Schoenborn Retractor	311
Schumacher	
Bone Lever	571
Umbilical Cord Scissor	73
Schumacher (Wagner) Bone Lever	571
Scoville	
Bone Curette	545-546
Retractor	369-371
Scoville-Haverfield Retractor	369-370
Scoville-Richter Retractor	371
Scudder Intestinal Clamp	613, 617
Sedillot Periosteal Elevator	555, 559
Segment Saw Blade	487
Segond Hysterectomy Forcep	269
Segond-Landau Hysterectomy Forcep	269
Seiffert Probe	379
Seldin Periosteal Elevator	554
Selenius Meniscus Knife	575
Selman Dissecting Forcep	161
Semb	
Bone Cutting Forcep	597
Bone Holding Forcep	582-583
Bone Rongeur	591
Periosteal Elevator	563
Semken	
Dissecting Forcep	154, 210
Dressing Forcep	145
Micro Dissecting Forcep	211

### S

	Page
Senn-Green Retractor	298
Senn-Miller Retractor	299
Sequestrum Bone Holding Forcep	581
Seutin Plaster of Paris Shear	95
Sewall Periosteal Elevator	553
Shaaf Splinter Forcep	185
Shea Vein Graft Scissor	56
Shepard Lens Holding Forcep	206
Silver	
Probe	378
Skin Graft Knife	24
Silver Skin Graft Knife Blade	25
Simon	
Bone Curette	546
Fistula Knife	21
Retractor	313
Sims	
Gynecological Scissor	36-38, 135
Rectal Speculum	619
Sims (Schulze-Bergmann) Rectal Speculum	619
Sims-Siebold Gynecological Scissor	37-38
Singley-Tuttle Dissecting Forcep	163
Skin Fixation Plate	24
Skin Graft Knife Blade	24
Skin Hook	290
Skull Breaker	517
Slender Pattern	
Dissecting Forcep	150
Dressing Forcep	142
Smillie	
Knee Retractor	572
Meniscus Knife	574
Smith (Mod. USA) Bandage Scissor	93
Smith-Peterson	
Bone Gouge	525
Bone Osteotome	524-525
Snyder-O.S.U Bone Gouge	519
Solution Bowl	649
Spencer Stitch Scissor	89
Spencer-Wells Haemostatic Forcep	225
Spherical Burr	496-497, 500
Spirit Lamp	657
Splinter Forcep	184-185
Spratt Bone Curette	544
Sputum Cup	655
St. Marks Pelvis Retractor	324



## Alphabetical Index

### S

	Page
Stacke (Silver) Probe	378
Standard Pattern	
Dissecting Forcep	149-150
Dressing Forcep	142
Steinert IOL Inserting Forcep	204
Steinhauser Bone Repositioning Forcep	579
Steinmann	
Extension Pins	505
Tendon Holding Forcep	577
Stella-S Facelift Scissor	134
Stellbrink Bone Rongeur	586
Stelzner Rectal Scissor	88-89
Stern-Gills Micro Scissor	106
Sternberg Retractor	327
Sternum Saw	493
Stevens Tenotomy Scissor	80-82, 136-137
Stieglitz Splinter Forcep	187
Stille	
Bone Chisel	524
Bone Gouge	524
Bone Osteotome	524
Bone Rongeur	591
Dissecting Forcep	152
Dissecting Scissor	35
Dressing Forcep	143-144
Drill Handle	496
Kidney Pedicle Clamp	264
Plaster of Paris Shear	485
Stille-Barraya Dissecting Forcep	162
Stille-Liston Bone Cutting Forcep	596
Stille-Luer Bone Rongeur	593
Stille-Ruskin Bone Rongeur	592
Stille-Sherman Hand Drill	496
Stockman Penis Clamp	646
Stone Dissecting Forcep	152
Strabismus Scissor	82-83
Strandell-Stille Retractor	300
Strassburger Modell Dissecting Forcep	165
Stratte Needle Holder	433, 461
Strauss	
Penis Clamp	646
Rectoscope	626-629
Strully	
Neurological Scissor	68
Vascular Scissor	67
Suction Haemorrhoidal Ligator	630

### S

	Page
Suction Raspatory	405
Suction Tube	399-400
Swedish Periosteal Elevator	565
Syme	
Ligature Needle	471
Periosteal Elevator	554
Systrunk Nail Splitting Scissor	30

### T

Tablet Tray	654
Taylor	
Dissecting Forcep	154-155
Dressing Forcep	145
Knee Retractor	573
Retractor	371
Taylor Mod. USA Percussion Hammer	388
Tendon Holding Forcep	578
Tendon Interlacing Forcep	578
Tendon Passing Instrument	576
Tendon Stripper	576
Tendon Tunnelling Forcep	577
Tennant Suture Tying Forcep	199
Tenotomy Scissor	55
Terrier Haemostatic Forcep	228
Thomas-Allis Intestinal & Tissue Grasping Forcep	607
Thorek Dissecting Scissor	50
Tibolt Punctal Scissor	102
Tissue Picker	294
Toennis	
Dissecting Scissor	69
Needle Holder	435, 467
Periosteal Elevator	566
Toennis-Adson Dissecting Scissor	69, 133
Tohoku Towel Clamp	276
Tonsil Needle	412-413
Toti Trepine	503
Towel Clamp	277
Townley Caliper	395
Traverse Self-Retaining Retractor	335
Trelat Periosteal Elevator	553
Trepine	496
Treves Dissecting Forcep	164
Trigeminal Knife	22



## Alphabetical Index

### T

	Page
Troutman	
Micro Needle Holder	444-445
Superior Rectus Forcep	196
Troutman-Castroviejo Corneoscleral Scissor	100
Troutman-Chris Blade Breaker	25
Troutman-Katzin Corneal Transplant Scissor	100
Tubing Clamp	278
Tudor-Edwards Retractor	316
Tuffier	
Abdominal Spatula	326
Haemostatic Forcep	226
Retractor	316
Tunneling Forcep	284
Tuohy Lumbar Puncture Needle	411
Turner Micro Dressing Forcep	145
Twist Drill	496-498, 501

### U

Ulrich	
Bone Holding Forcep	584-585
Dressing Forcep	281
Fistula Knife	21
Universal	
Bandage Scissor	95
Tray	650-651
Trocar	399
Wire Cutting Scissor	90, 139
Unna Comedone Extractor	602-603
Unna-Vidal Comedone Extractor	604
Urethral Retractor	326
Uro Tangential Forcep	263
Utrata Capsulorhexis Forcep	198

### V

Vacuum Cleaner	488
Van Buren	
Bone Holding Forcep	582
Urethral Sound	641-642

### V

	Page
Vannas	
Capsulotomy Scissor	103-104
Micro Scissor	106-107, 109
Varady Varix Instrument	385-386
Vascular Scissor	59, 66-67
Vasectomy Dissecting Forcep	635
Vasectomy Fixation Clamp	635
Veidenheimer Sigmoid Anastomosis Clamp	618
Vein Cannula	411
Verbrugge Bone Holding Forcep	586
Verbrugge-Mueller Bone Lever	570
Verhoeven Suction Cannula	403
Vernier Calliper	395-396
Verres Insufflation Cannula	413
Very Delicate Operating Scissor	77-78
Vessel Clip, Mini	219
Vickers	
Bone Mallet	542
Low Profile Retractor	357-358
Vidal Lupus Scraper	601
Virchow	
Autopsy Knife	18
Brain Knife	19
Cartilage Knife	18
Skull Breaker	517
Vise Grip Plier	515
Vise Micro Jeweller Forcep	160
Volkmann	
Bone Curette	543-544, 549
Retractor	301-303
Vollmar	
Stripper	383-384
Vessel Irrigation Cannula	413

### W

Wachenfeldt Clip Applying Forcep	482
Wagner	
Bone Gouge	531
Bone Lever	567
Operating Scissor	75
Periosteal Elevator	561
Waisted Saw Blade	487
Walb Post Mortem Knife	19



## Alphabetical Index

### W

	Page
Waldmann Nasal Scissor	73
Walton Finger Ring Saw	598
Wangensteen	
Dressing Forcep	213
Needle Holder	433, 462
Ward Periosteal Elevator	553
Wartenberg Sensibility Instrument	389
Wassmund Retractor	305
Watson Skin Graft Knife	23
Watson-Cheyne Periosteal Elevator	565
Watson-Jones Bone Lever	571
Waugh	
Dissecting Forcep	154
Dressing Forcep	147
Webster Needle Holder	428, 458-459
Wecker Iris Scissor	98-99
Weitlaner Self-Retaining Retractor	335-338
Weitlaner-Baby Self-Retaining Retractor	342
Weitlaner-Wullstein Self Retaining Retractor	339
Weller Dissecting Scissor	41
Wertheim	
Gynecological Scissor	38, 135
Hysterectomy Forcep	269, 271-272
Vaginal Clamp	267
Wertheim (Rogers) Hysterectomy Forcep	268
Wertheim-Cullen Vaginal Clamp	267
Westcott	
Stitch Scissor	102
Tenotomy Scissor	101-102
Wickstroem Dissecting & Ligature Forcep	261
Wies Chalazion Forcep	209
Williams Intestinal & Tissue Grasping Forcep	608
Williger	
Bone Curette	549-550
Bone Mallet	537, 539
Periosteal Elevator	561, 564
Wilson Haemostatic Forcep	244
Wire Cutting Plier	515-517
Wire Strainer	506
Wire Twisting Forcep	511-512
Wolff	
Lupus Curette	601
Plaster Breaker	486
Wound Retractor	294-295, 297-298, 301, 311
Wound Spreader	333
Wullstein Suction Tube	402-403

### V

	Page
Yankauer Suction Tube	406-407
Yasargil	
Micro Forcep	167
Micro Needle Holder	438-439, 441
Micro Scissor	110
Suction Tube	404-405
Tumor Grasping Forcep	166
Yeoman (Turrell) Rectal Biopsy Forcep	631-633
Young	
Ligature Needle	469-470
Prostatic Retractor	640

### Z

Zaufal-Jansen Bone Rongeur	590
Zenker	
Dissecting & Ligature Forcep	258
Retractor	310
Ziegler Head Mirror	391
Zielke Bone Gouge	532
Zoellner Suction Tube	402
Zweifel Needle Holder	434, 466











#### COPYRIGHT NOTICE

The copyright, trademarks, domain names and other intellectual property rights in all materials and information in this presentation belongs to Surtex Instruments Ltd. All rights are reserved. Technical alterations are possible. This presentation may be used for no other purpose than offering, buying and selling of Surtex Instruments products. No part may be reproduced or copied in any form. In the event of misuse we retain the right to recall our catalogues and take appropriate legal action.

#### DISCLAIMER

This documents provides general information about Surtex Instruments Ltd, its products and services, and summarises general capabilities and offerings, which we deem to be relevant to our customers. Whilst Surtex Instruments has taken appropriate steps to ensure the accuracy of the information contained in the document Surtex Instruments gives no warranty regarding the accuracy or completeness of such information.

The presentation was prepared to provide information and does not constitute a contract. Surtex reserves the right, without prior notice, to change, delete, supplement, or otherwise amend at any time the information, images and offerings contained in the presentation or other documents. Surtex shall not be liable for any loss or damage of whatever nature (whether direct, indirect, consequential or other) may arise as a result of any third party relying on the information contained in this document.

For further detailed information, prices, terms and conditions, customer should contact Surtex Instruments at [sales@surtex-instruments.co.uk](mailto:sales@surtex-instruments.co.uk).

© 2015 SURTEX INSTRUMENTS. ALL RIGHTS RESERVED. PRINTED IN UNITED KINGDOM. BT1-01 Rev 1.0



47 Kingston Hill, London  
KT2 7PS, United Kingdom  
Phone: +44 (0) 208 123 3513

E-mail: [sales@surtex-instruments.co.uk](mailto:sales@surtex-instruments.co.uk)  
Website: [www.surtex-instruments.co.uk](http://www.surtex-instruments.co.uk)

