



Page 01-37

○ Wound Retractors



HI-001 Sharp
HI-002 Blunt
GRAEFE
125 mm



HI-003 125 mm
HI-004 130 mm
Sharp
GUTHRIE



HI-005 130 mm
HI-006 135 mm
Sharp
ROLLET
HI-007 135 mm
Blunt



HI-008
FRAZIER
Dura Retractors
130 mm

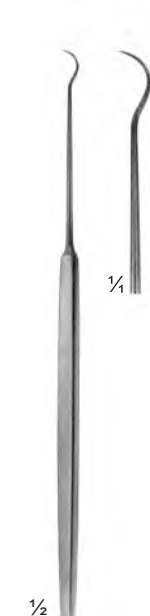

HI-009
TONNIS
Dura Retractors
150 mm



HI-010
KILNER
160 mm

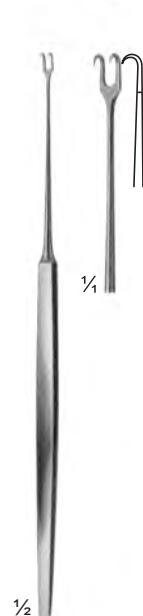

HI-011
FREER
150 mm



HI-012
MULLER
150 mm



HI-013
MULLER
150 mm
HI-013-1
MULLER
180 mm

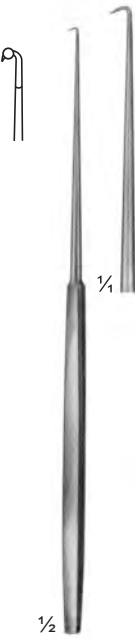

HI-014
COTTLE
160 mm



HI-015
COTTLE
160 mm

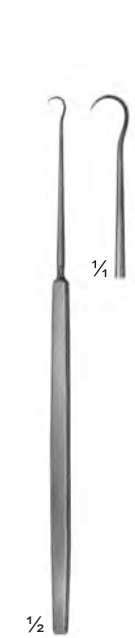

HI-016
JAEGAR
135 mm



HI-017 - 020
JOSEPH
165 mm



HI-021 - 022
GILLIES
180 mm



HI-023
KILNER
Sharp
80 mm

HI-024
CONVERSE
Blunt
120 mm

WOUND - TRACHEA RETRACTORS

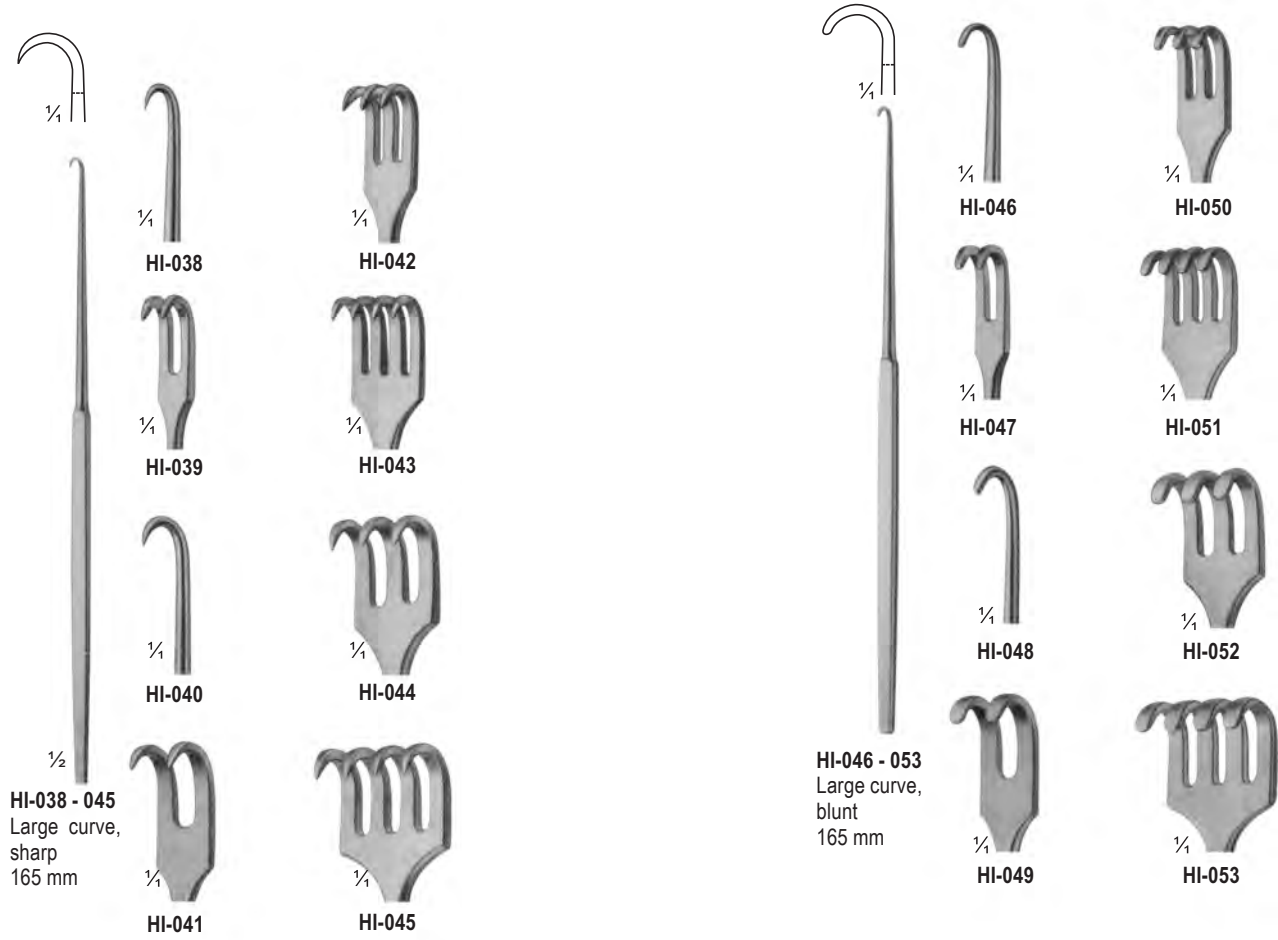
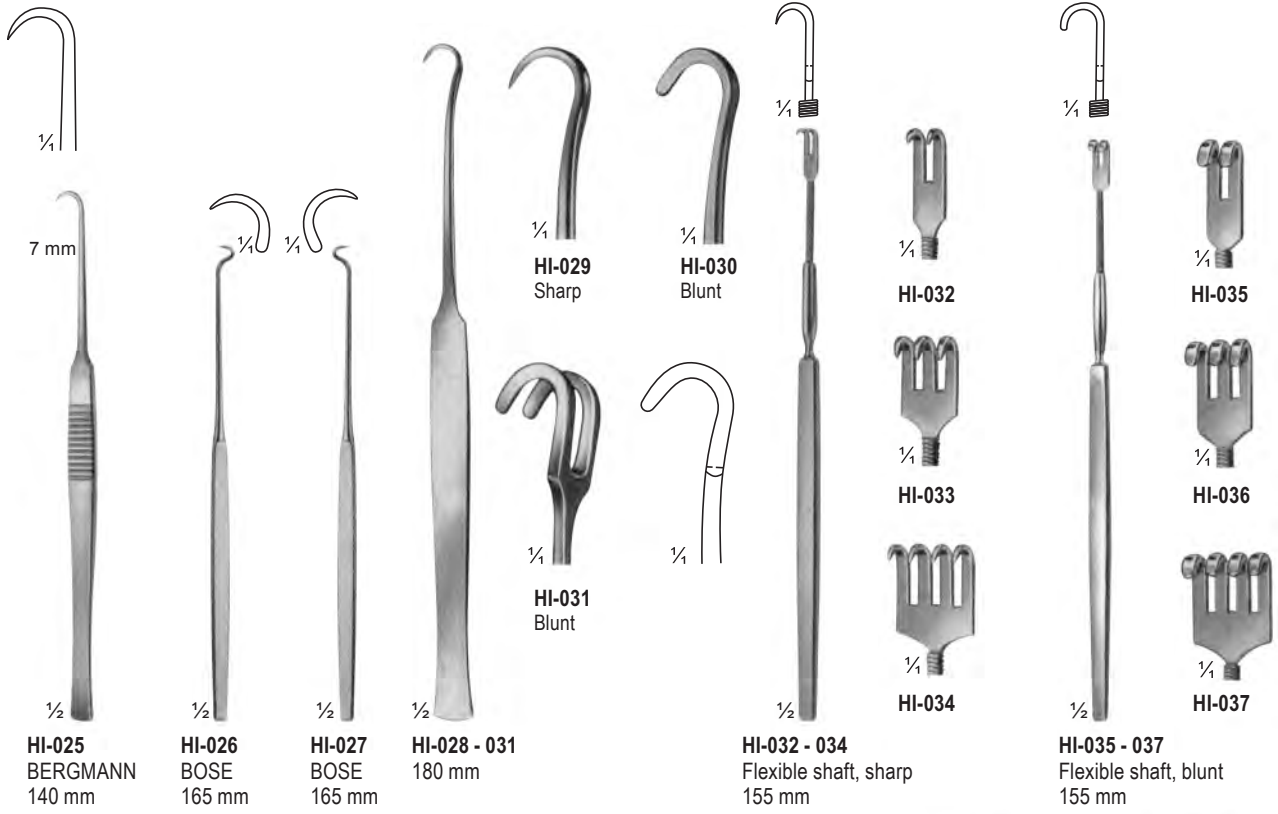

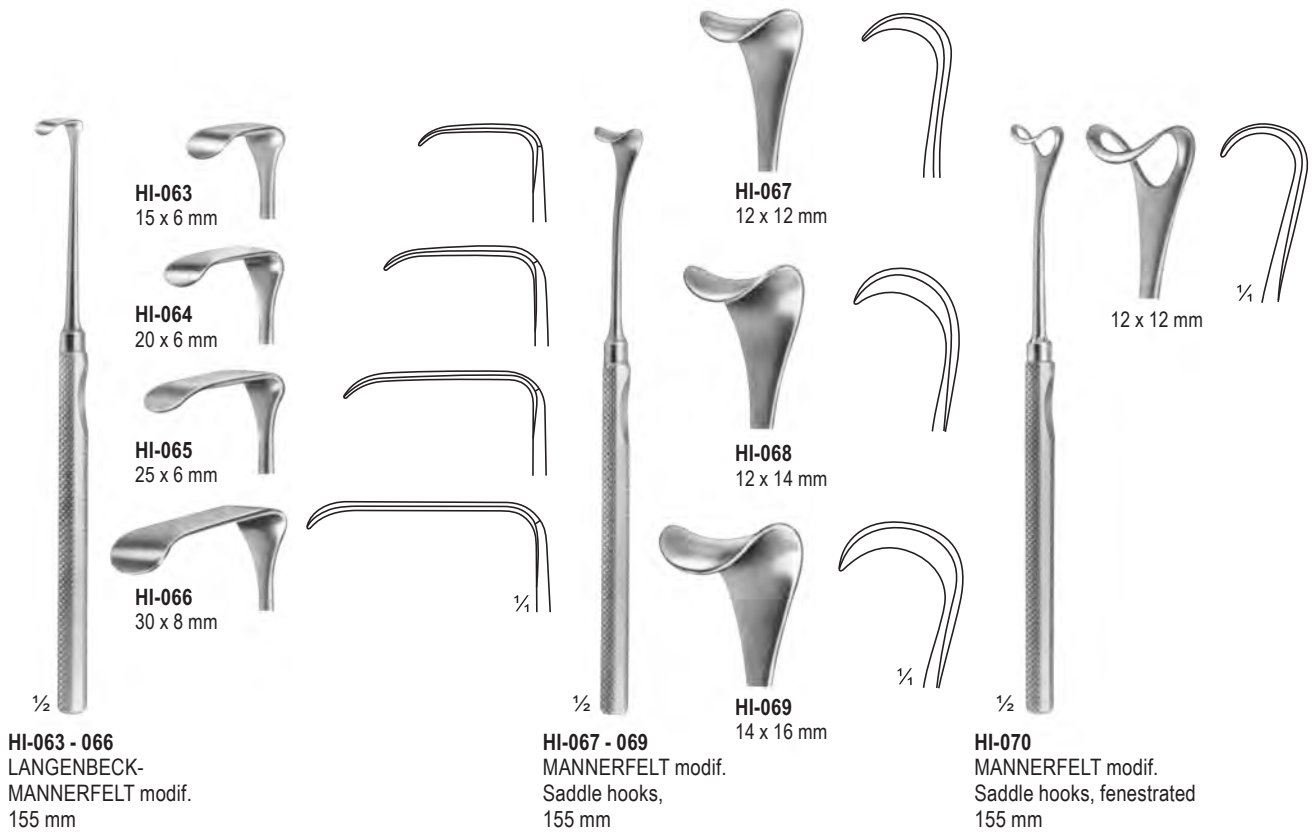
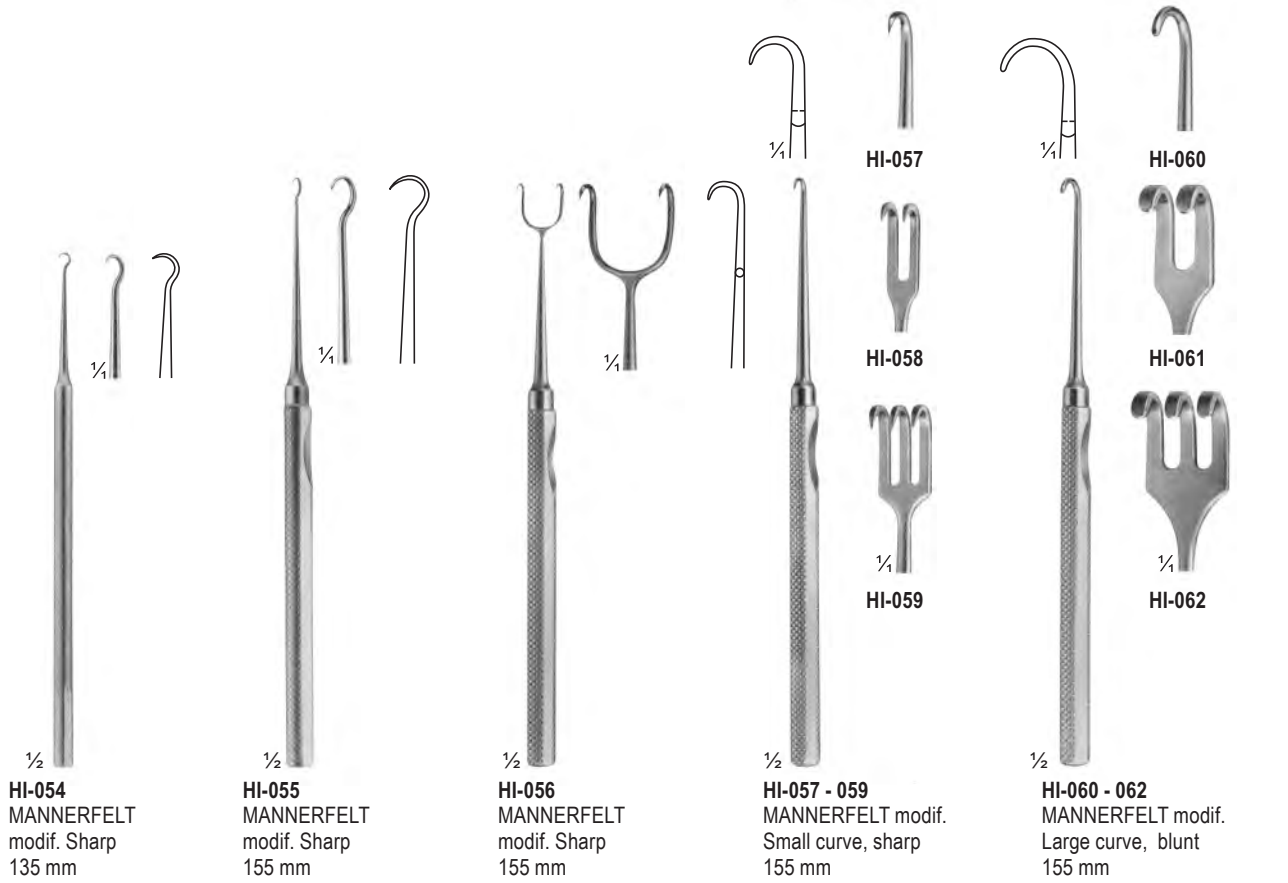



RETRACTORS

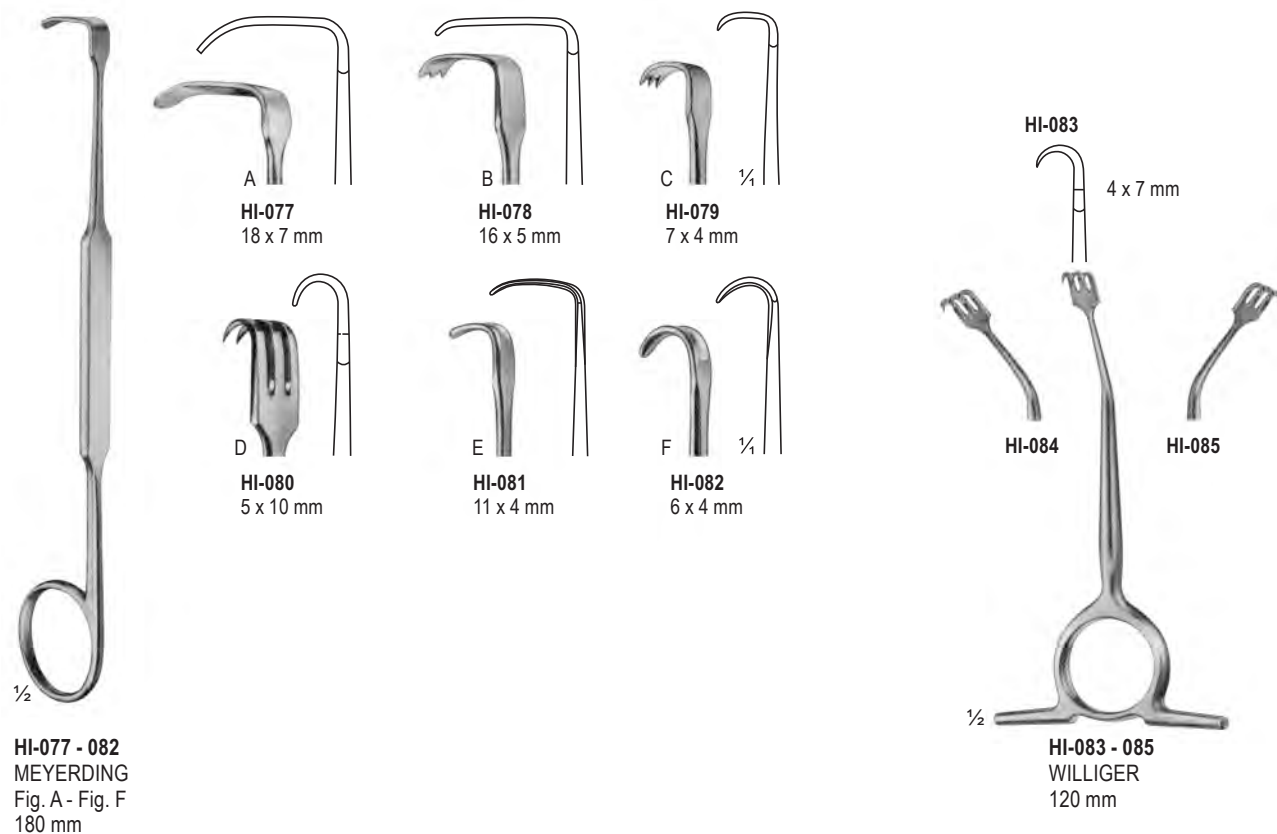
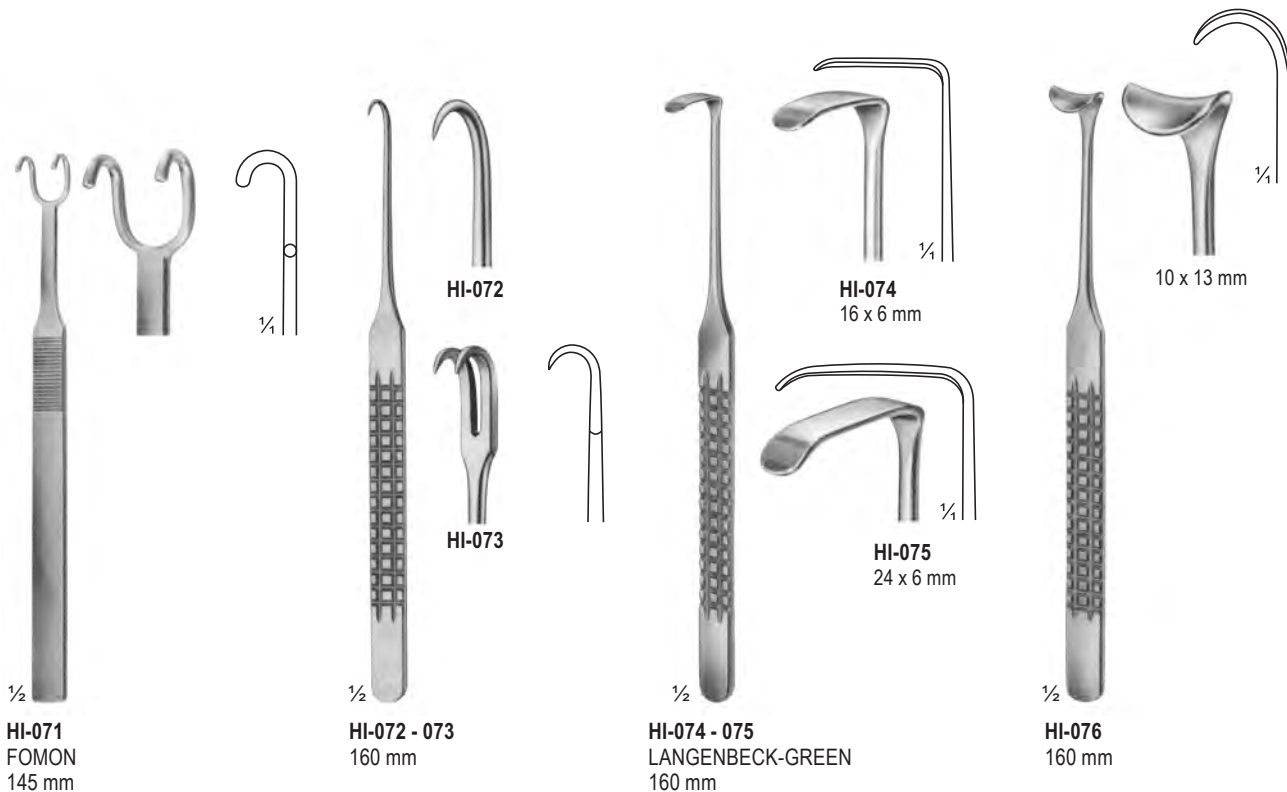



1/2
HI-086
EMMETT
Fistula hook
220 mm



1/2
HI-087
SIMON
Fistula hook
220 mm



1/2
HI-088
SIMON
Fistula hook
220 mm

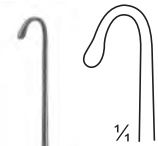

1/2
HI-089
LANGE
Fistula hook
230 mm

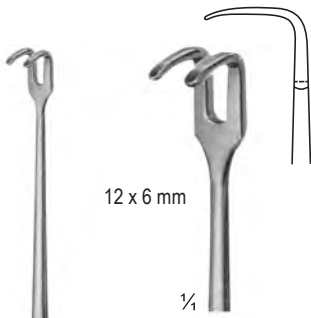

12 x 6 mm

1/4
HI-090



12 x 11 mm

1/4
HI-091

1/2
HI-090 - 091
Tendon hooks
175 mm

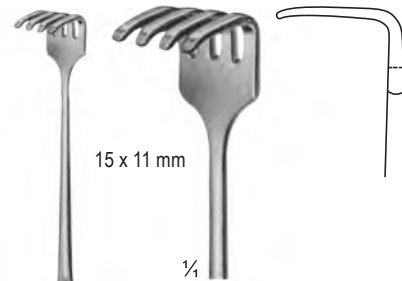

15 x 11 mm

1/4

1/2
HI-092
KLAPP
Tendon hooks
175 mm

WOUND AND VEIN RETRACTORS

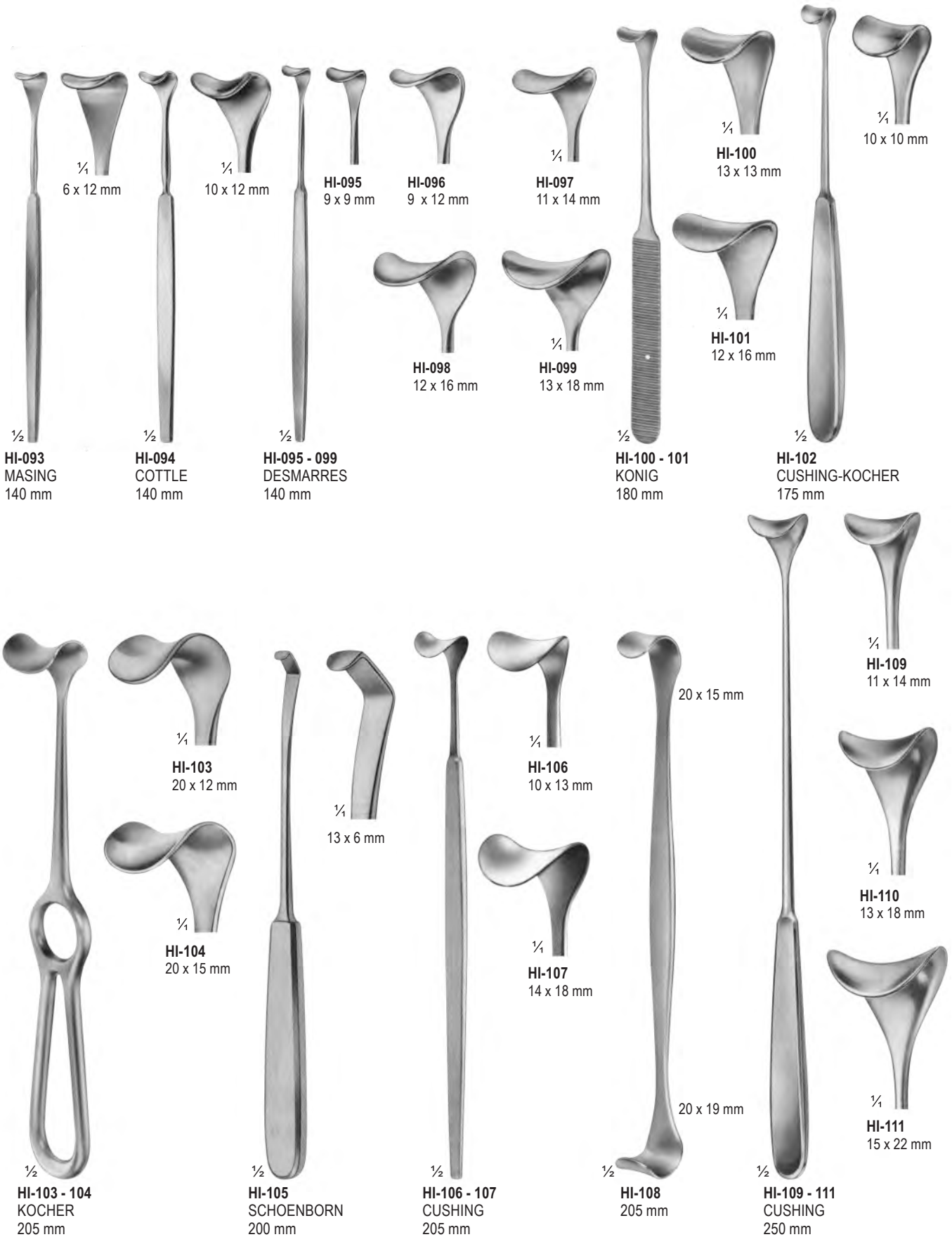

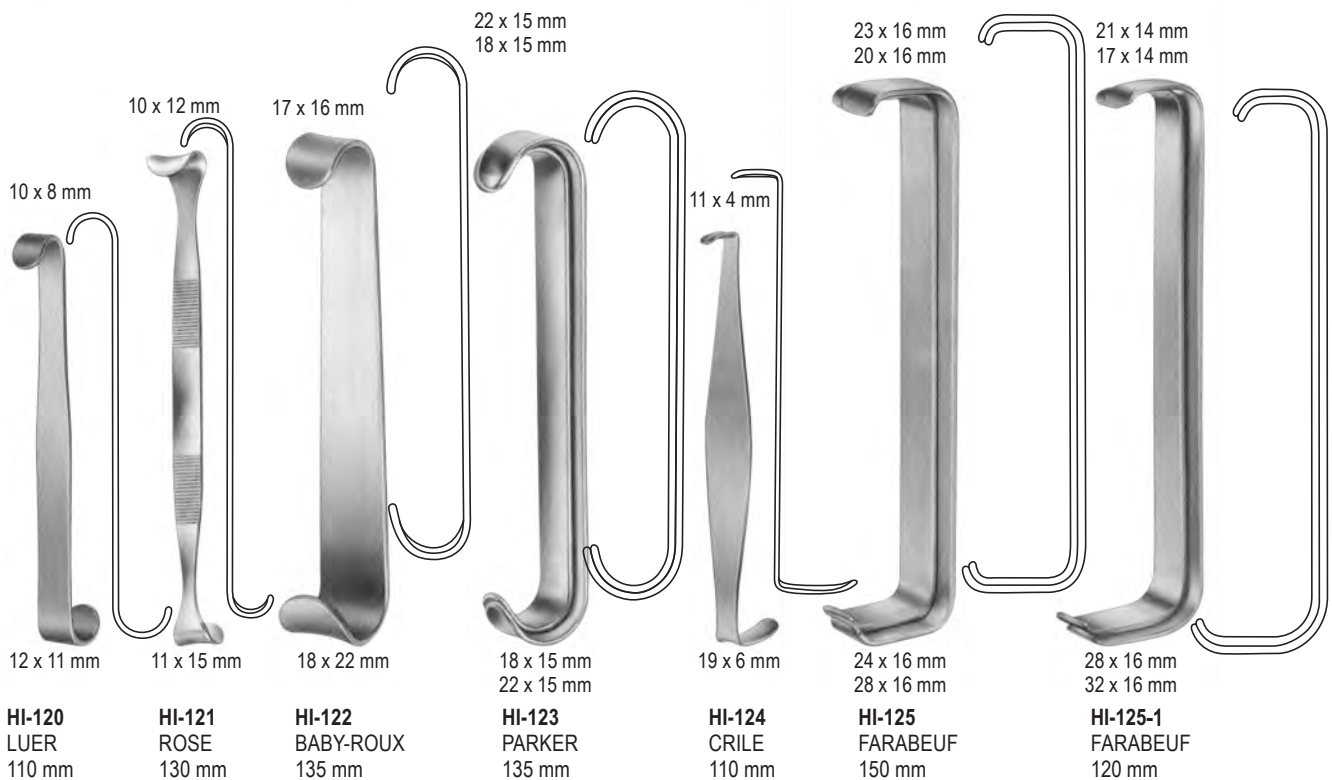
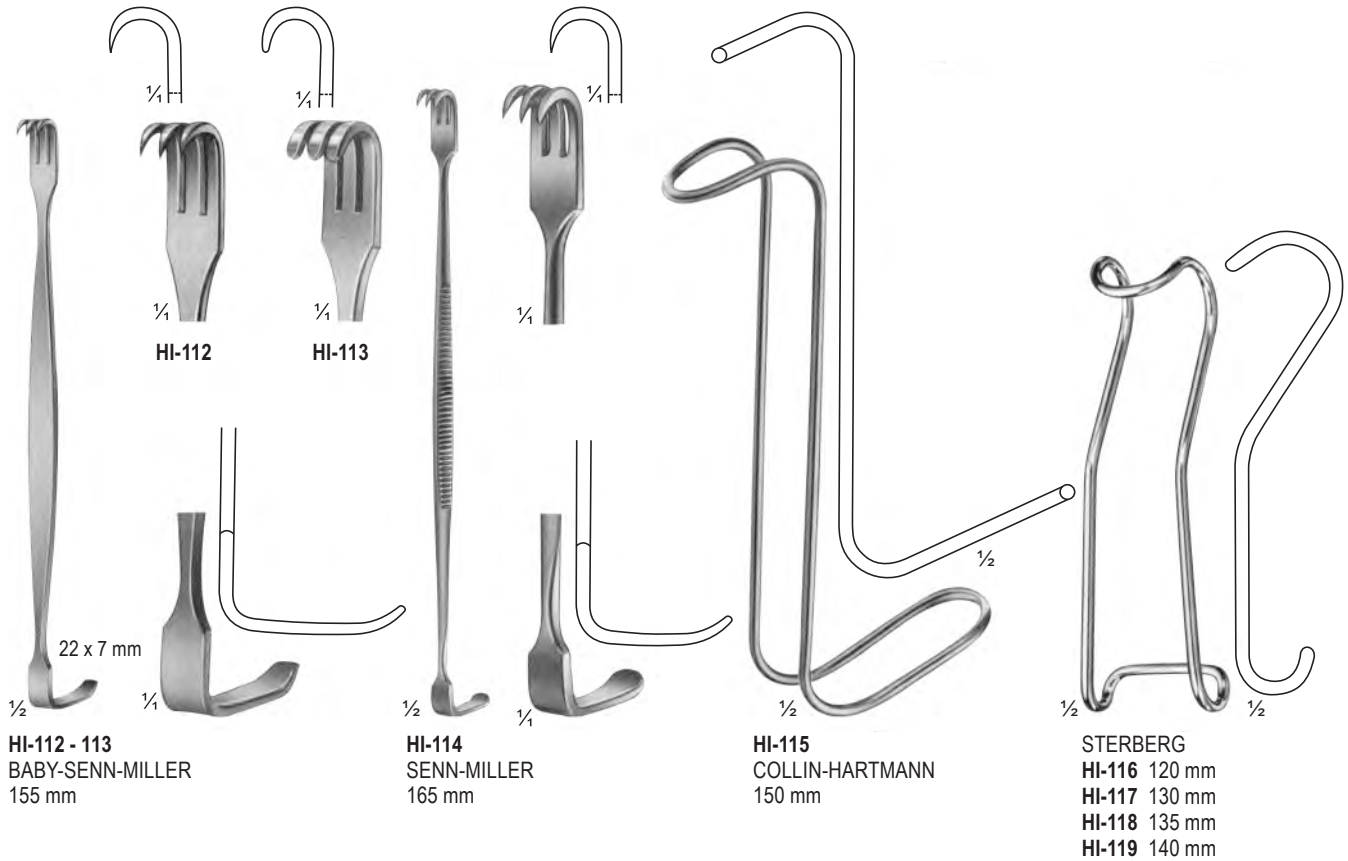

RETRACTORS

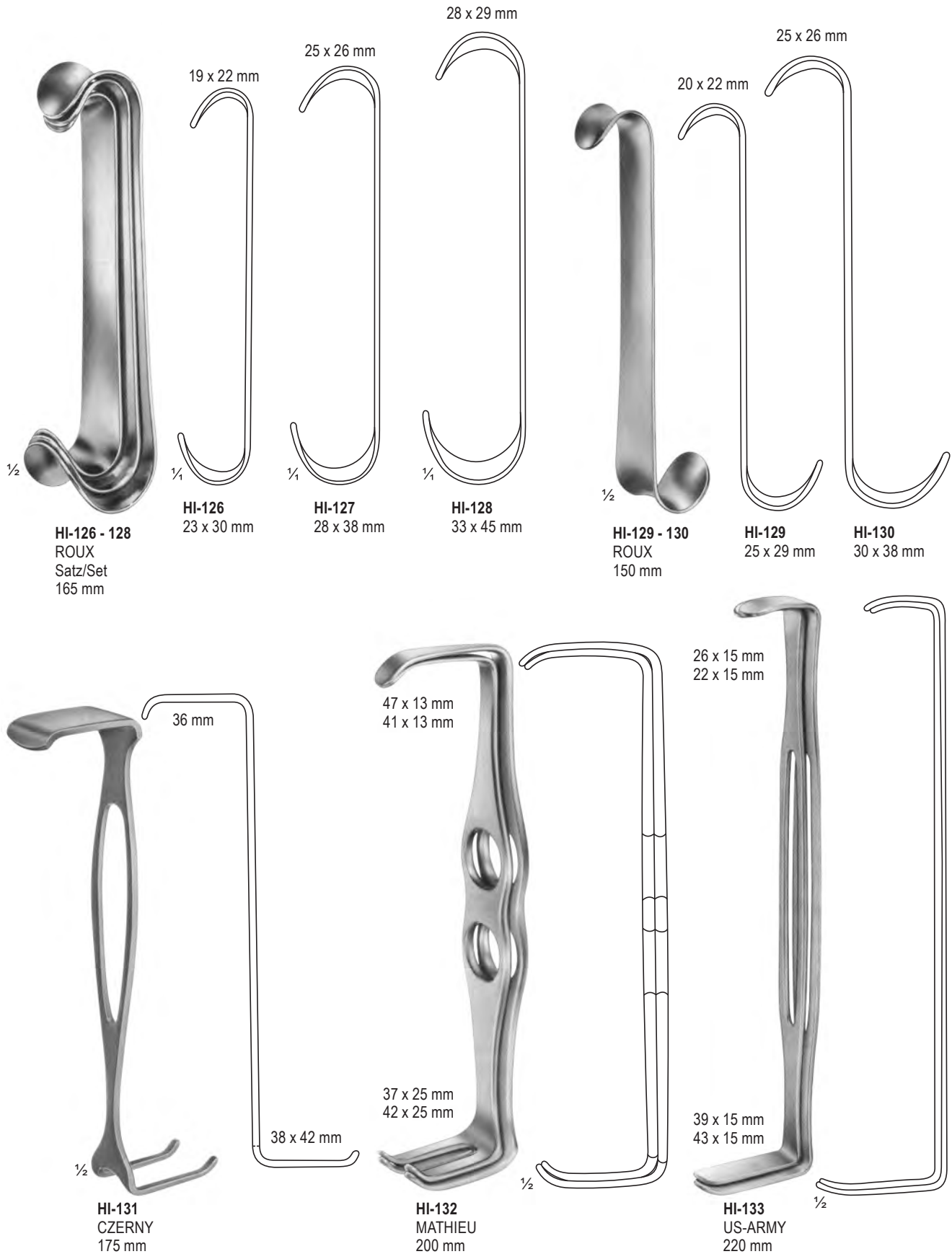



HI-134
KOCHER
Sharp
205 mm



HI-135
KOCHER
Sharp
220 mm



HI-136
KOCHER
Blunt
220 mm



HI-137
VOLKMANN
Sharp
220 mm



HI-138
VOLKMANN
Sharp
220 mm



HI-139 - 146
VOLKMANN
225 mm

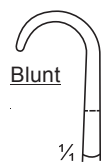
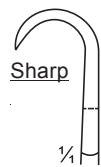

HI-139
9 x 8 mm



HI-140
9 x 13 mm



HI-141
9 x 19 mm



HI-142
9 x 29 mm



HI-143
8,5 x 8 mm



HI-144
8,5 x 13 mm



HI-145
8,5 x 19 mm



HI-146
8,5 x 29 mm

RETRACTORS

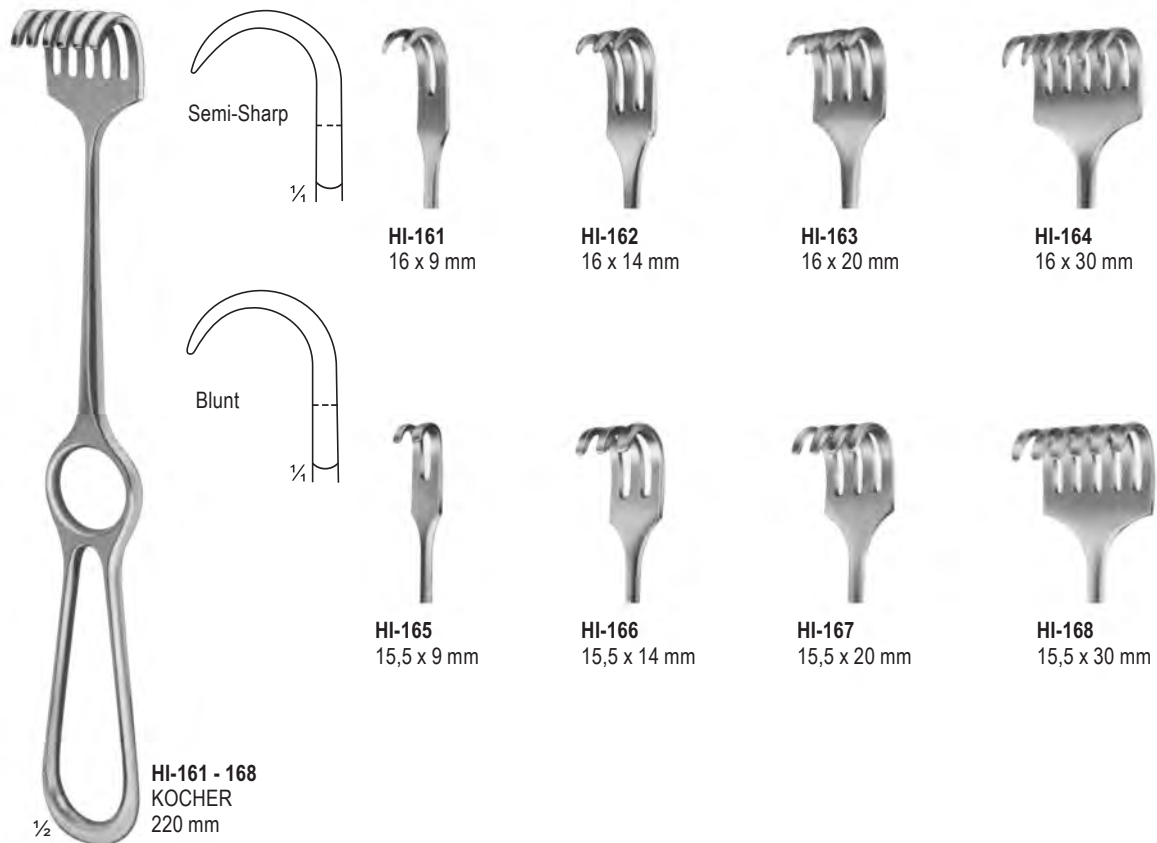
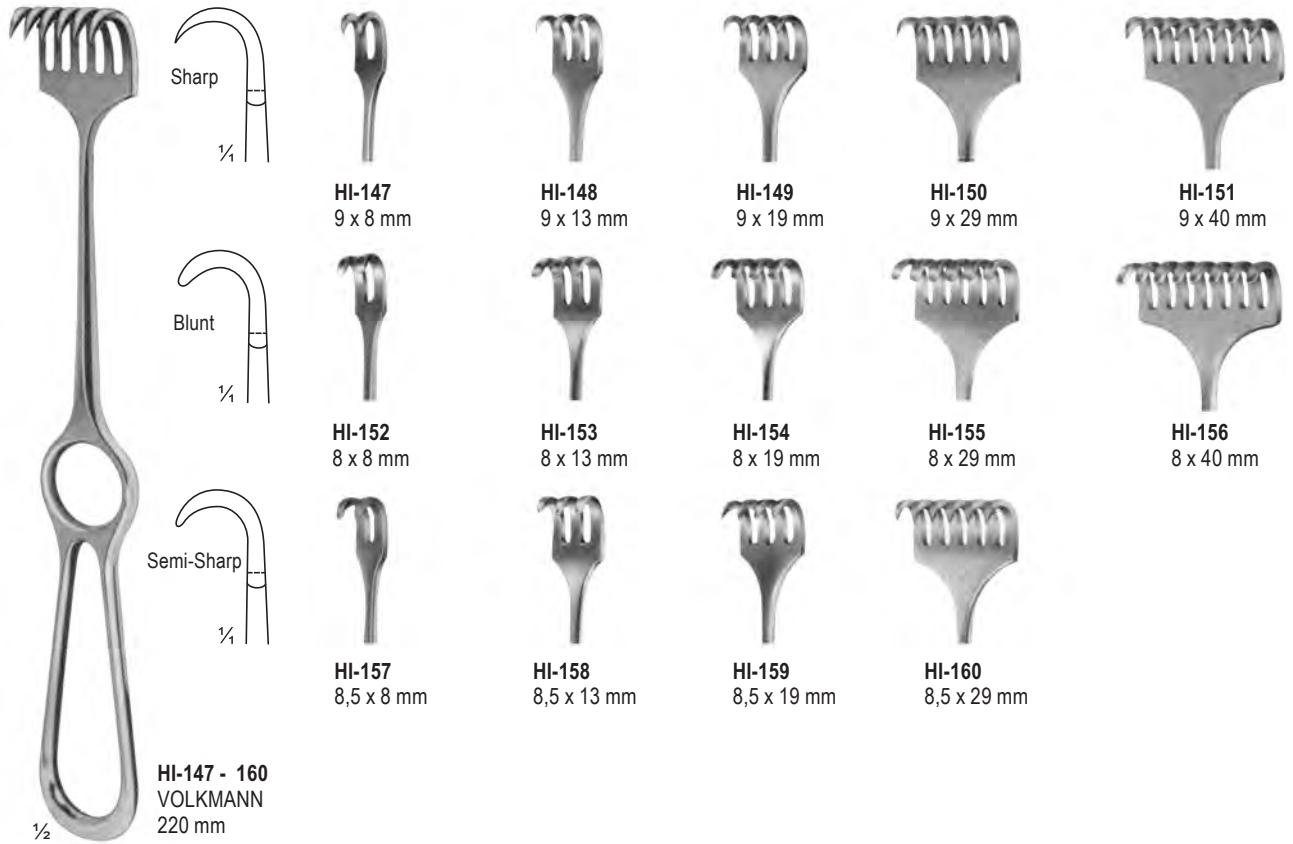



HI-168 - 170
KORTE
240 mm



HI-169
8 Prongs, blunt



HI-170
8 Prongs, sharp



HI-171 - 174
ISRAEL
255 mm

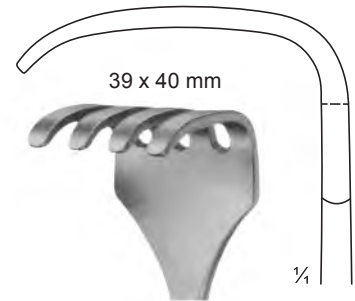

HI-171
4 Prongs, blunt

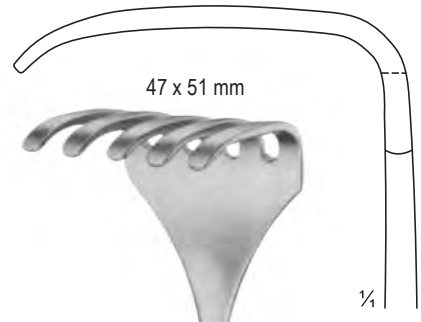

HI-172
5 Prongs, blunt

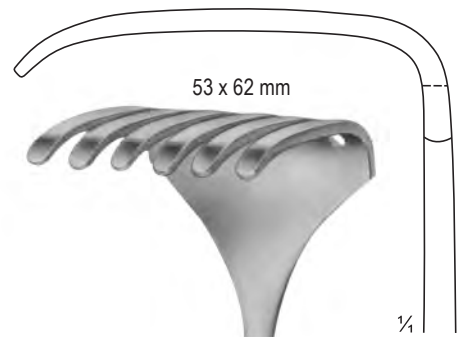

HI-173
6 Prongs, blunt

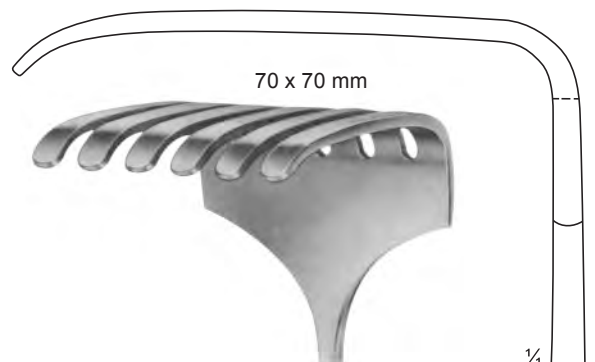

HI-174
6 Prongs, blunt



RETRACTORS



HI-175

HI-175 - 180
LANGENBECK
210 mm

- HI-175 28 x 10 mm
- HI-176 28 x 14 mm
- HI-177 33 x 14 mm
- HI-178 28 x 16 mm
- HI-179 40 x 10 mm
- HI-180 40 x 13 mm



HI-181

HI-181 - 187
KOCHER-LANGENBECK
215 mm

- HI-181 25 x 6 mm
- HI-182 35 x 8 mm
- HI-183 35 x 11 mm
- HI-184 35 x 15 mm
- HI-185 41 x 11 mm
- HI-186 55 x 11 mm
- HI-187 70 x 14 mm

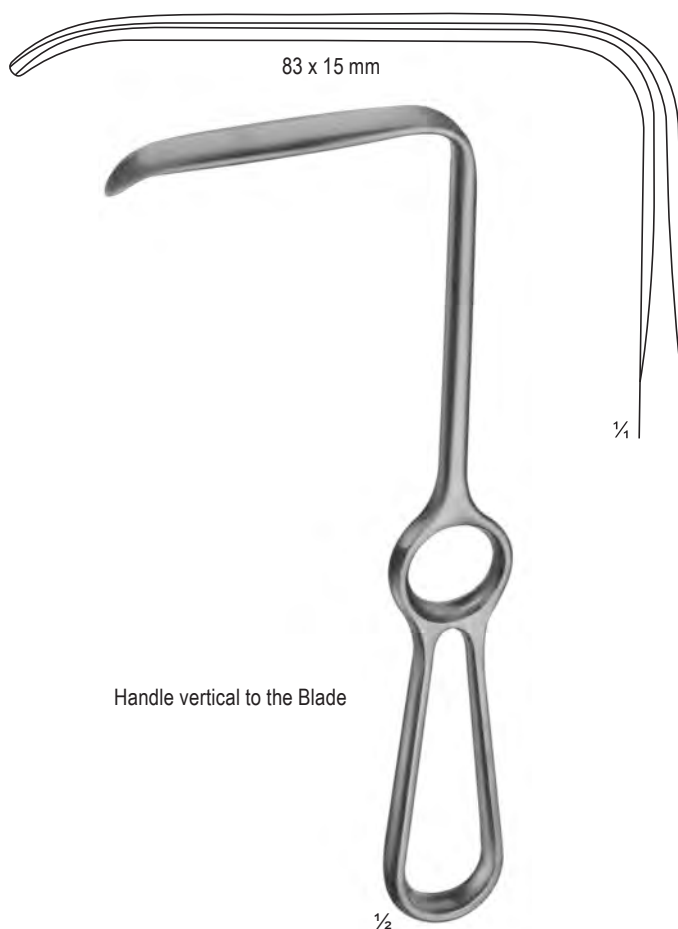

83 x 15 mm

Handle vertical to the Blade

HI-188
LANGENBECK
215 mm



HI-189 - 193
KOCHER
230 mm

1/2



HI-194 - 196
SAUERBRUCH
225 mm

1/2

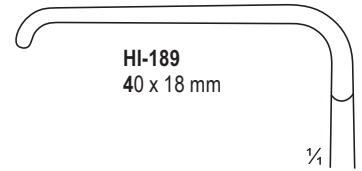

HI-189
40 x 18 mm

1/4

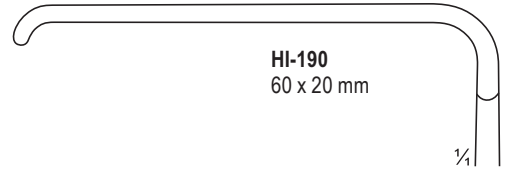

HI-190
60 x 20 mm

1/4

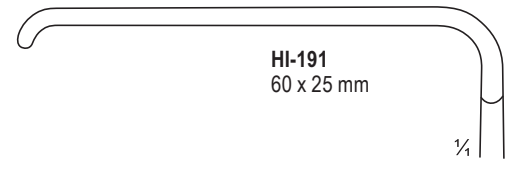

HI-191
60 x 25 mm

1/4

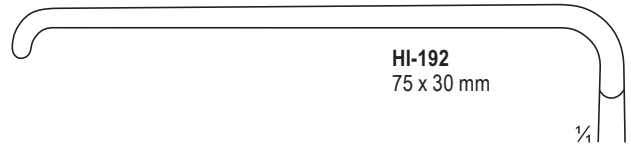

HI-192
75 x 30 mm

1/4

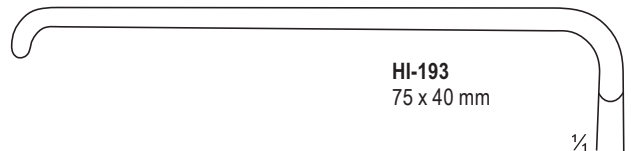

HI-193
75 x 40 mm

1/4

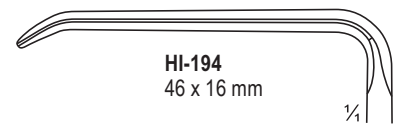

HI-194
46 x 16 mm

1/4

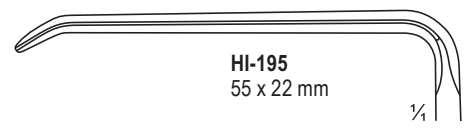

HI-195
55 x 22 mm

1/4

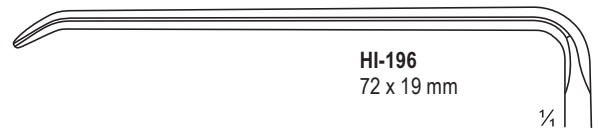

HI-196
72 x 19 mm

1/4



RETRACTORS



HI-197 -199
MIDDELDORPF



HI-197
15 x 15 mm
220 mm



HI-198
20 x 22 mm
215 mm



HI-199
28 x 28 mm
235 mm

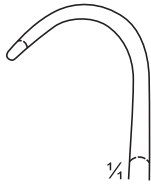

1/4

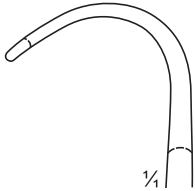

1/4

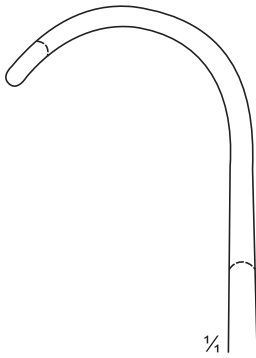

1/4



HI-200
BUCHS
205 mm



38 x 18 mm

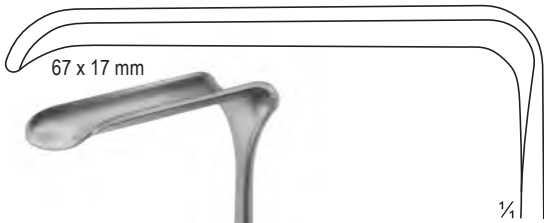

67 x 17 mm

1/4



HI-201
CASPAR
210 mm

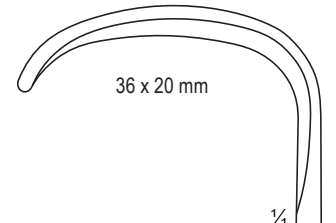

36 x 20 mm

1/4

HI-202
KOCHER
230 mm



$\frac{1}{2}$
HI-203 - HI-208
 HOSEL
 250 mm

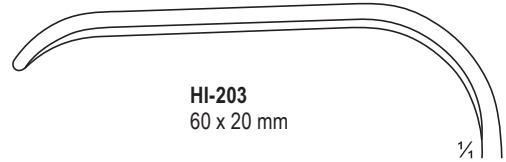

HI-203
 60 x 20 mm

$\frac{1}{4}$

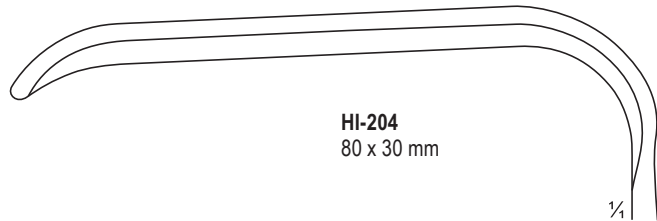

HI-204
 80 x 30 mm

$\frac{1}{4}$

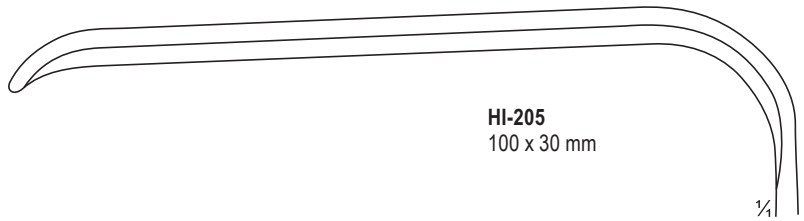

HI-205
 100 x 30 mm

$\frac{1}{4}$

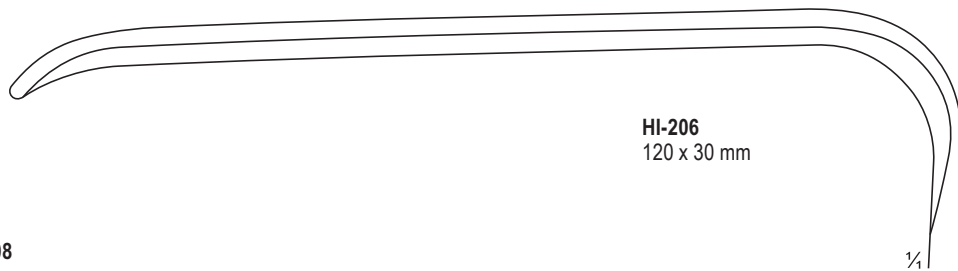

HI-206
 120 x 30 mm

$\frac{1}{4}$

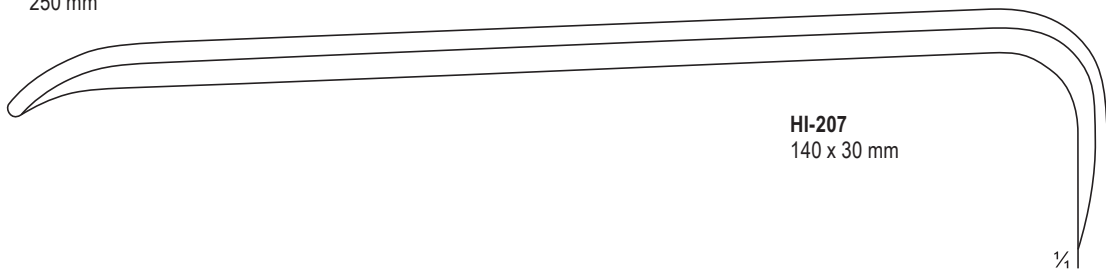

HI-207
 140 x 30 mm

$\frac{1}{4}$

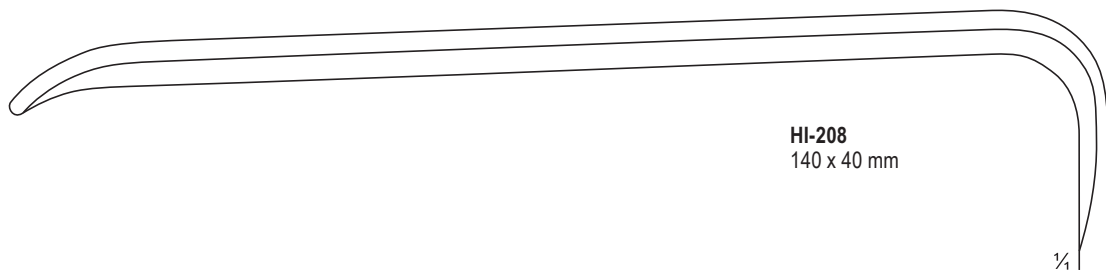

HI-208
 140 x 40 mm

$\frac{1}{4}$



RETRACTORS

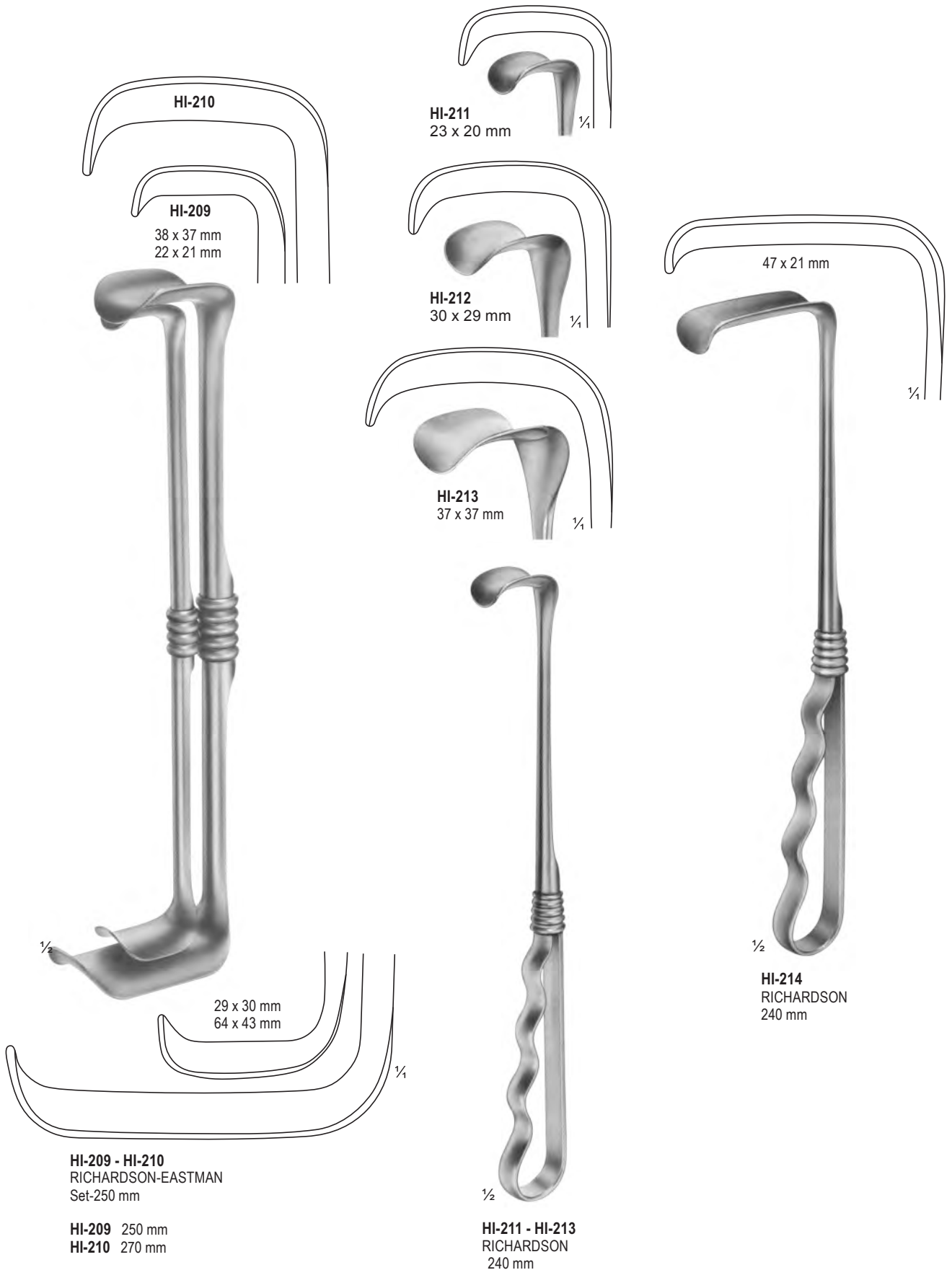

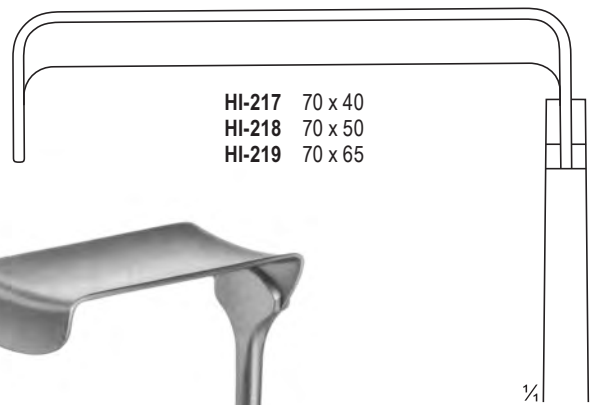
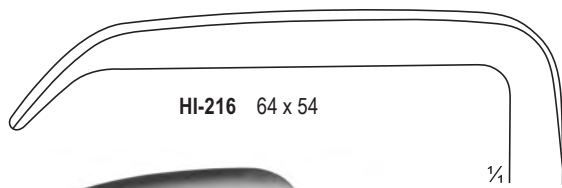
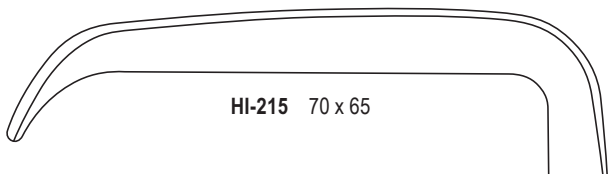

HI-215 - HI-216
 KELLY
 260 mm



HI-217 - HI-219
 MORRIS
 245 mm



RETRACTORS FOR DEEP SURGERY

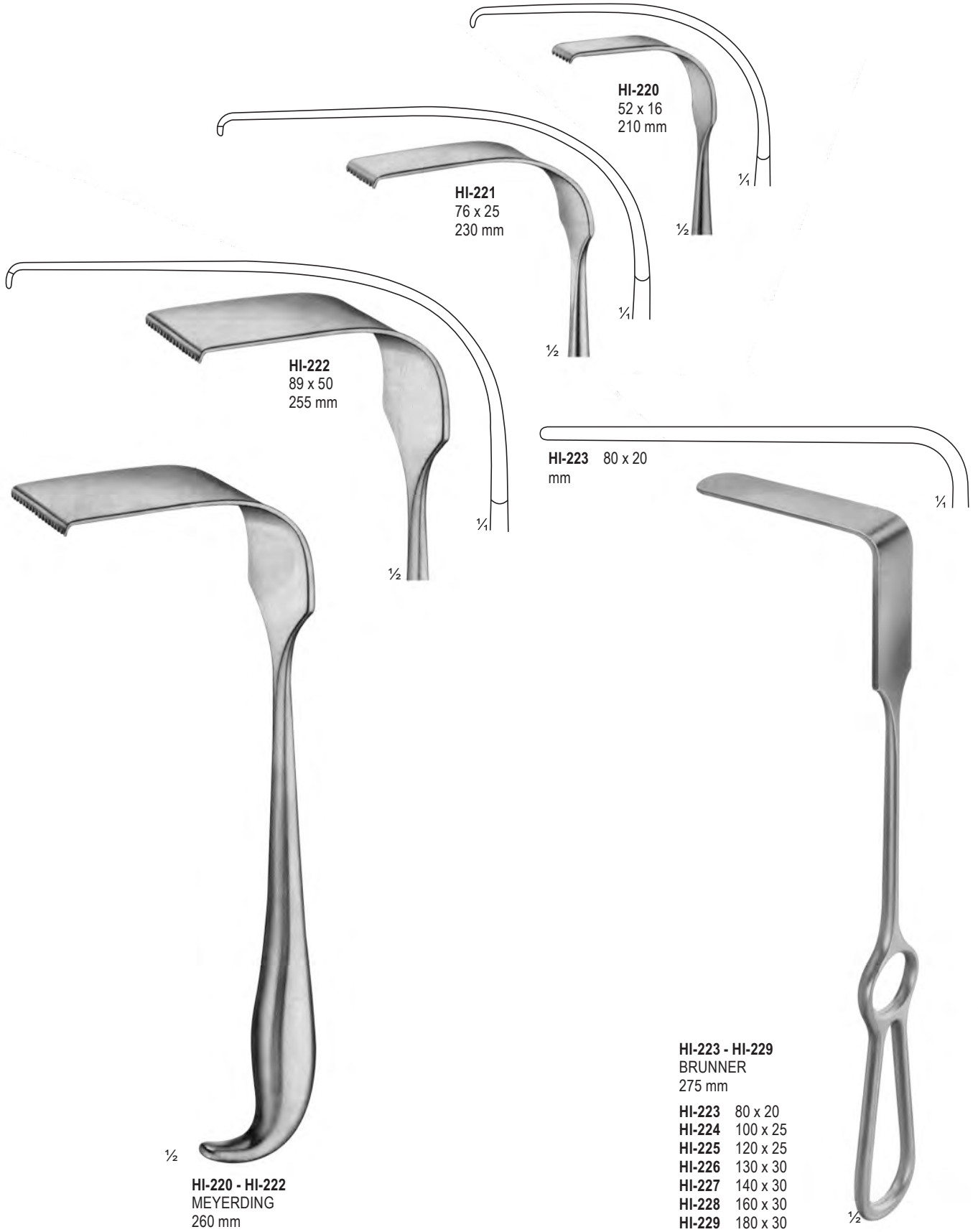

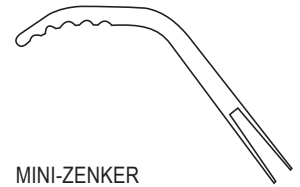

**MINI-ZENKER
HI-230**
180 mm
10 X 3 mm

1/4

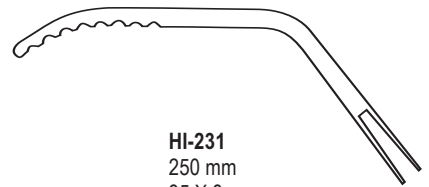

HI-231
250 mm
35 X 8 mm

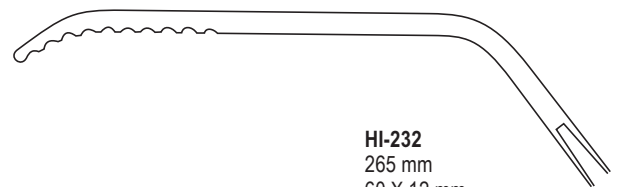

HI-232
265 mm
60 X 12 mm

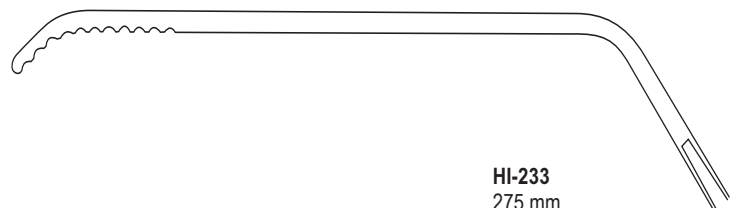

HI-233
275 mm
75 X 12 mm

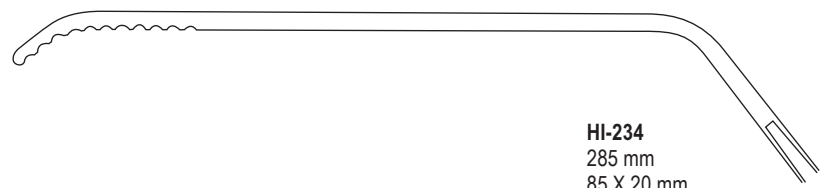

HI-234
285 mm
85 X 20 mm

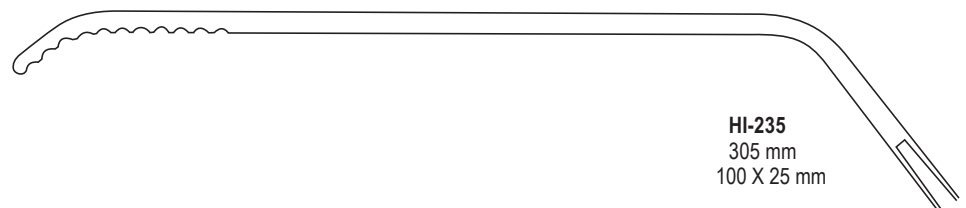

HI-235
305 mm
100 X 25 mm



1/2

**ZENKER
HI-230 - HI-235**



RETRACTORS



HOSEL
HI-236 - HI-241
250 mm

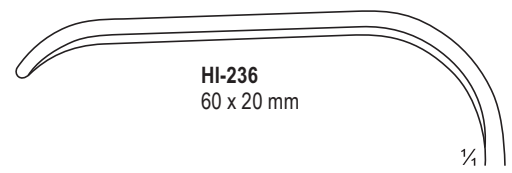

HI-236
60 x 20 mm

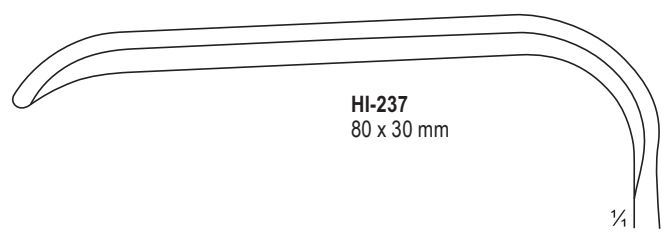

HI-237
80 x 30 mm

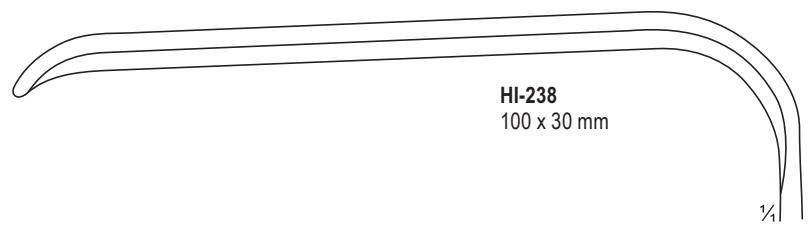

HI-238
100 x 30 mm

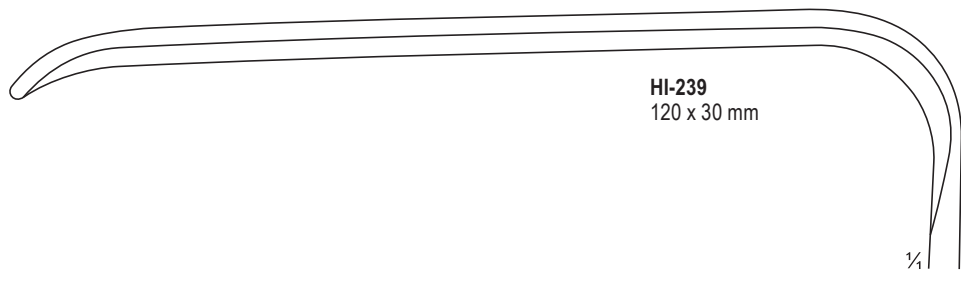

HI-239
120 x 30 mm

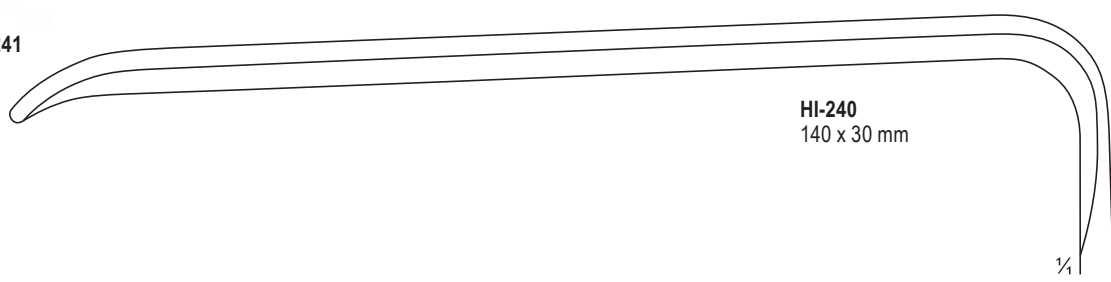

HI-240
140 x 30 mm

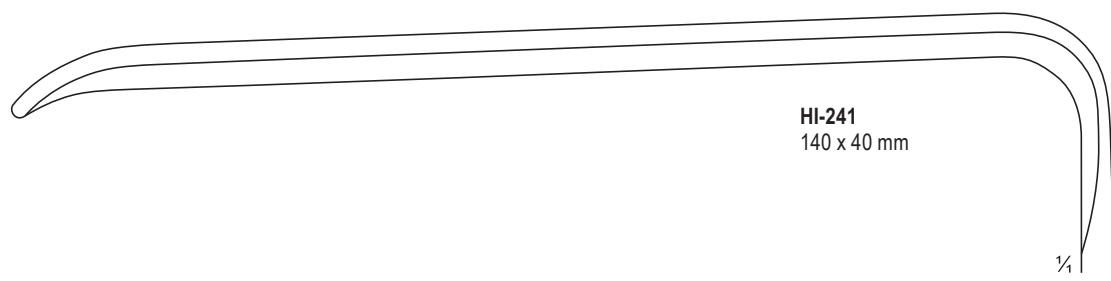

HI-241
140 x 40 mm



HÖSEL
HI-242 - HI-247
260 mm

1/2

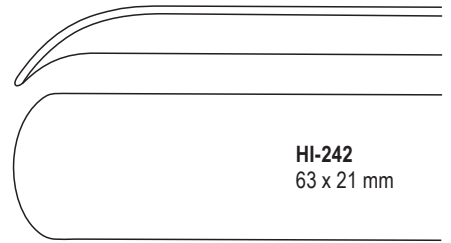

HI-242
63 x 21 mm

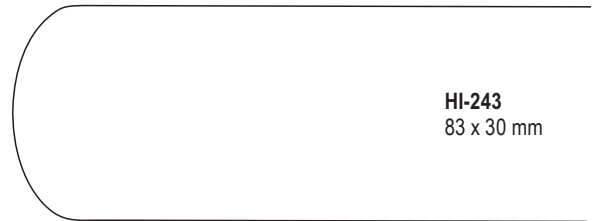

HI-243
83 x 30 mm

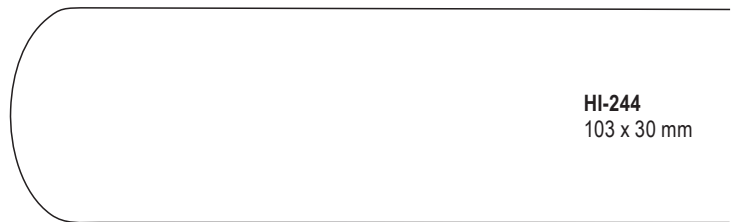

HI-244
103 x 30 mm

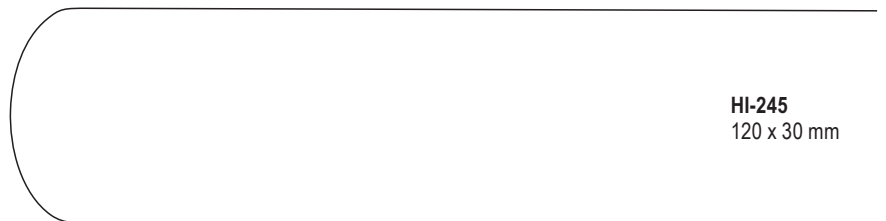

HI-245
120 x 30 mm

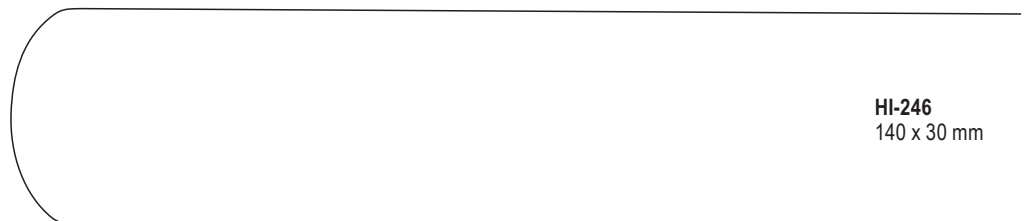

HI-246
140 x 30 mm

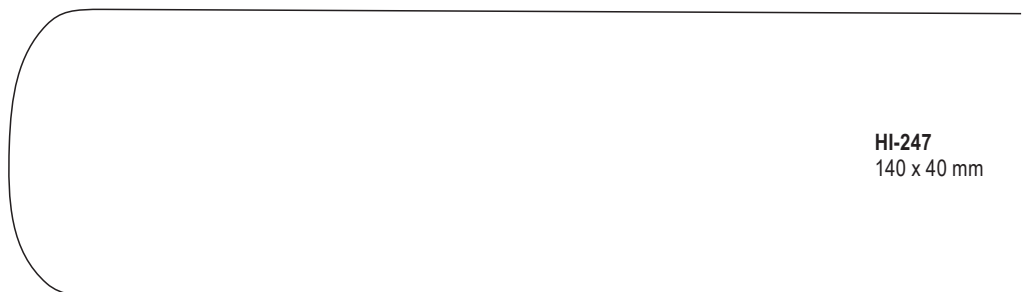

HI-247
140 x 40 mm



RETRACTORS



¼

HI-248
270 mm
43 X 45 mm

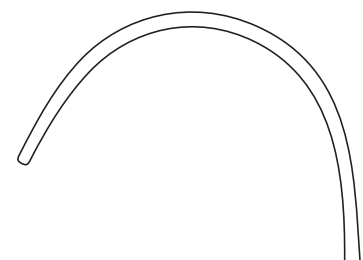

½

MIDDENDORPF
HI-248 - HI-250



HI-249
270 mm
52 X 50 mm

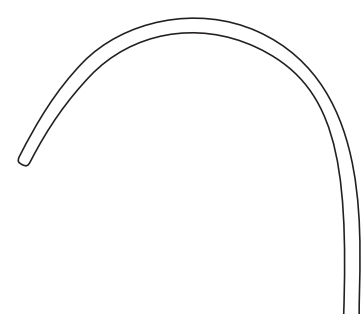

HI-250
280 mm
52 X 70 mm

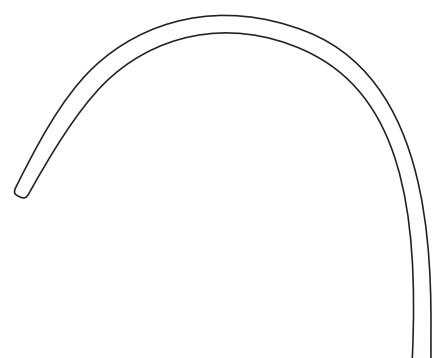

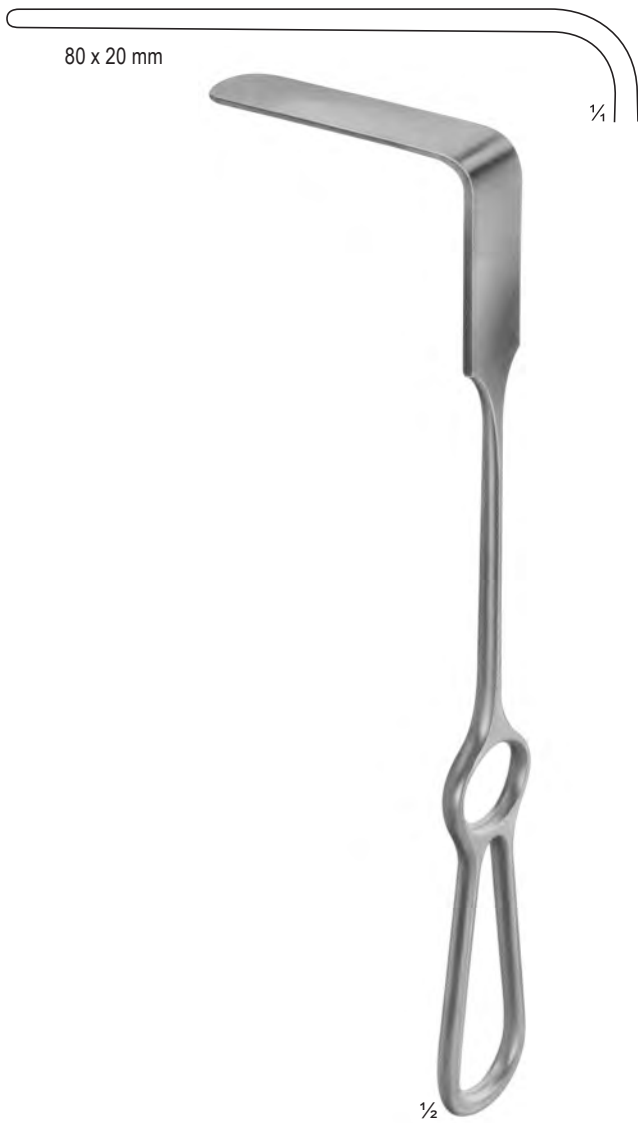

BRUNNER
HI-251 - HI-257
 275 mm

- HI-251** 80 x 20
- HI-252** 100 x 25
- HI-253** 120 x 25
- HI-254** 130 x 30
- HI-255** 140 x 30
- HI-256** 160 x 30
- HI-257** 180 x 30

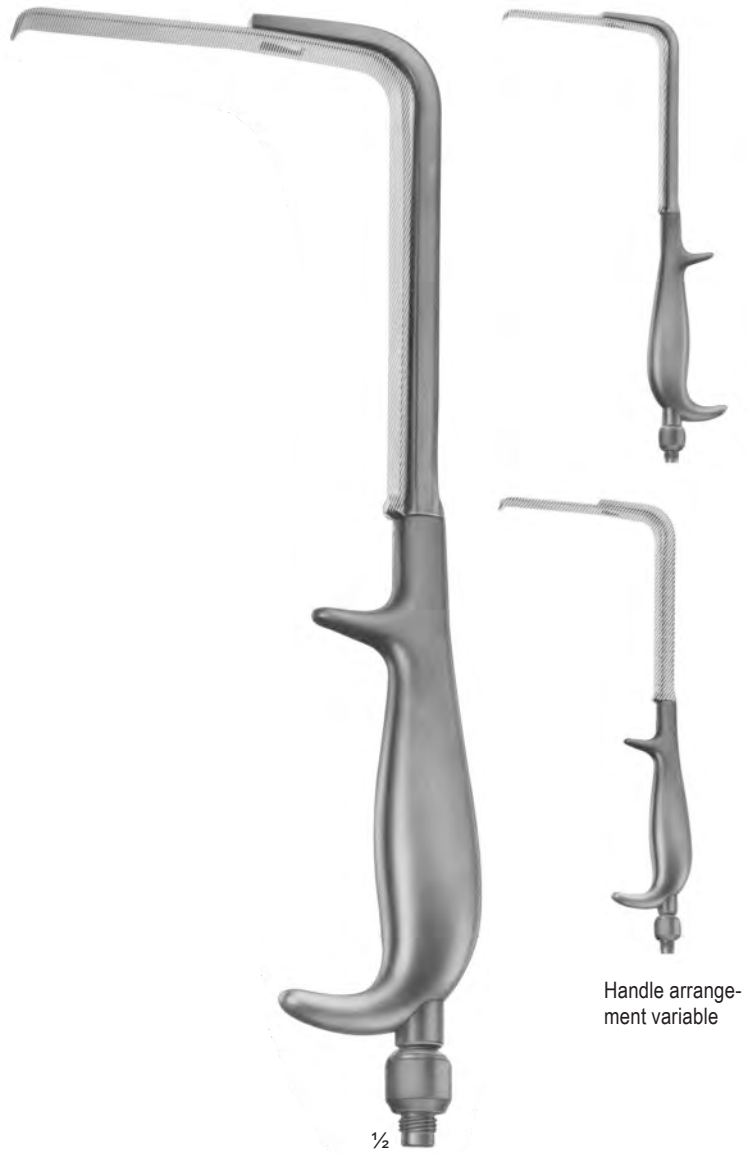

HI-258
 Handle with cold
 light carrier for
 retractor blades.
 280 mm

Handle arrange-
 ment variable



RETRACTORS

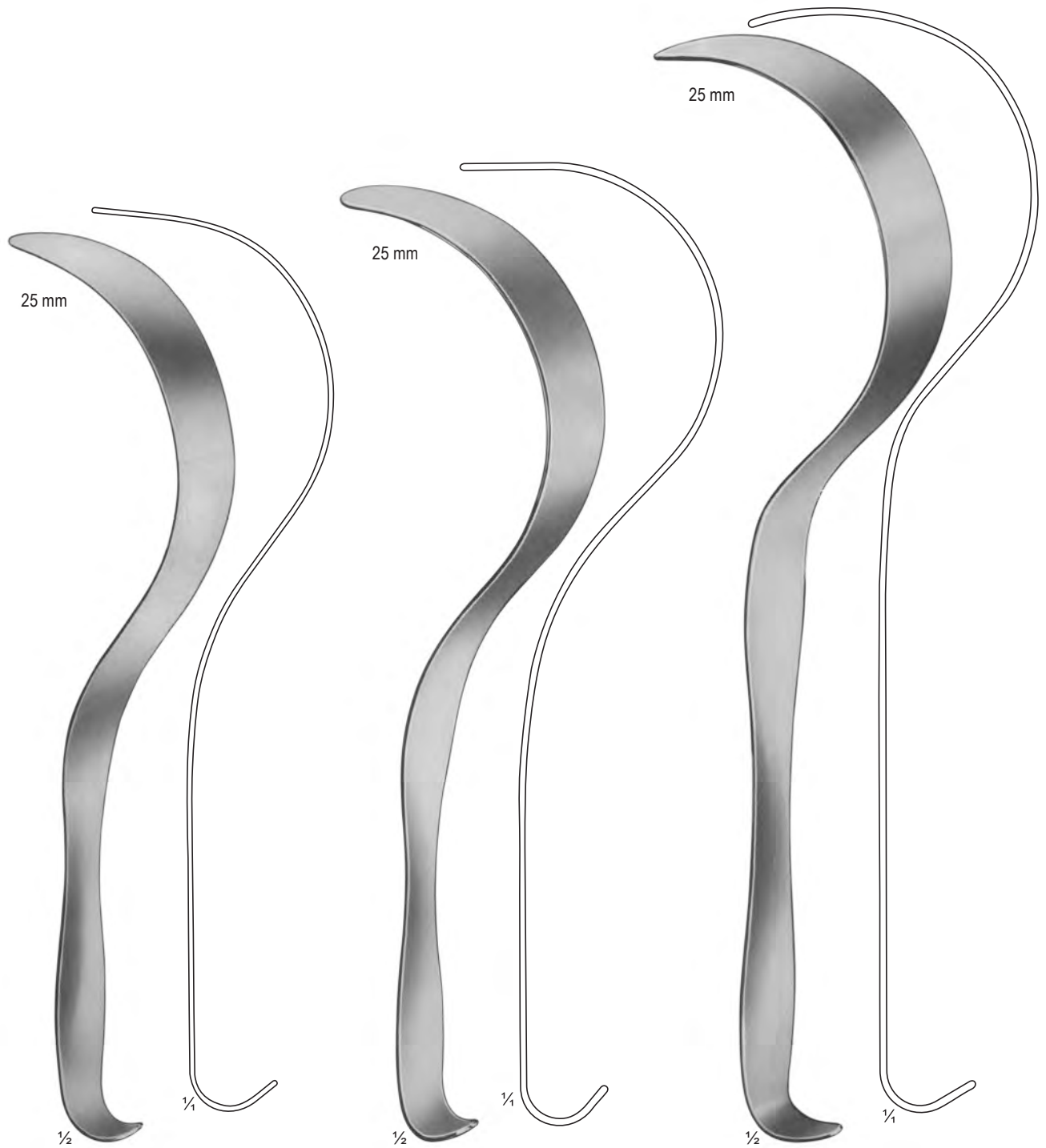

HI-259
DEAVER
300 mm
Fig. 1

HI-260
DEAVER
315 mm
Fig. 2

HI-261
DEAVER
365 mm
Fig. 2



Fig. 3
DEAVER
HI-262
300 mm

Fig. 4
DEAVER
HI-263
310 mm

Fig. 5
DEAVER
HI-264
320 mm



RETRACTORS

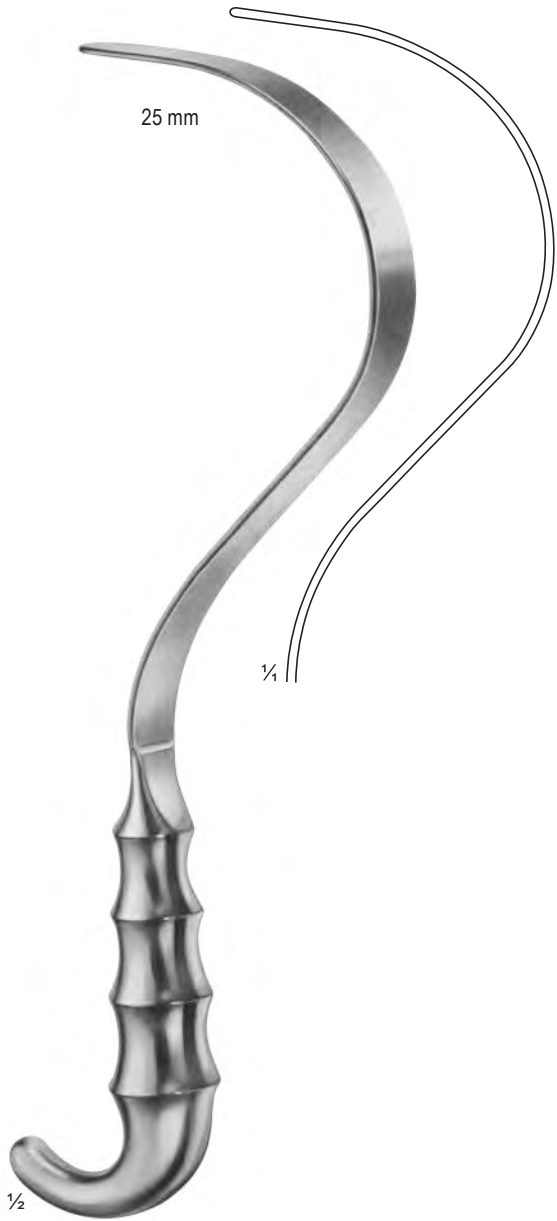

HI-265
DEAVER
310 mm
Fig. 1



HI-266
DEAVER
310 mm
Fig. 3



1/2

COOLEY
HI-267
 250 mm
 Right
 48 X 48 mm



1/2

COOLEY
HI-268
 250 mm
 Right, Serrated
 48 X 48 mm



1/2

COOLEY
HI-269
 275 mm
 Left
 30 X 48 mm

ABDOMINAL RETRACTORS



ROCHARD
HI-270 - HI-274
 310 mm
HI-270 48 x 90 mm
HI-271 48 x 105 mm
HI-272 48 x 120 mm
HI-273 48 x 135 mm
HI-274 48 x 155 mm



HI-275



DOYEN
HI-276 - HI-279
 280 mm
HI-276 48 x 90 mm
HI-277 48 x 105 mm
HI-278 48 x 120 mm
HI-279 48 x 135 mm



DOYEN-CHILD
HI-280
 Fixation device
 220 mm



HI-281
 Chain with
 weight (747 / 645g)
 790 mm



SENN-GREEN
HI-282 - HI-283
160 mm



Fig. 1
HI-282
20 X 6 mm



Fig. 2
HI-283
10 X 6 mm



RAGNELL-DAVIS
HI-284
150 mm



Fig. 1
1/4
8 X 4.5 mm

Fig. 2
15 X 5.5 mm



CUSHING
HI-285
205 mm

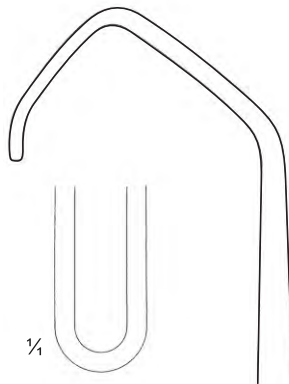

Fig. 1
1/4

19 x 15 mm
19 x 15 mm



22 x 15 mm
22 x 15 mm

PARKER
HI-286
140 mm



RETRACTORS FOR DEEP SURGERY

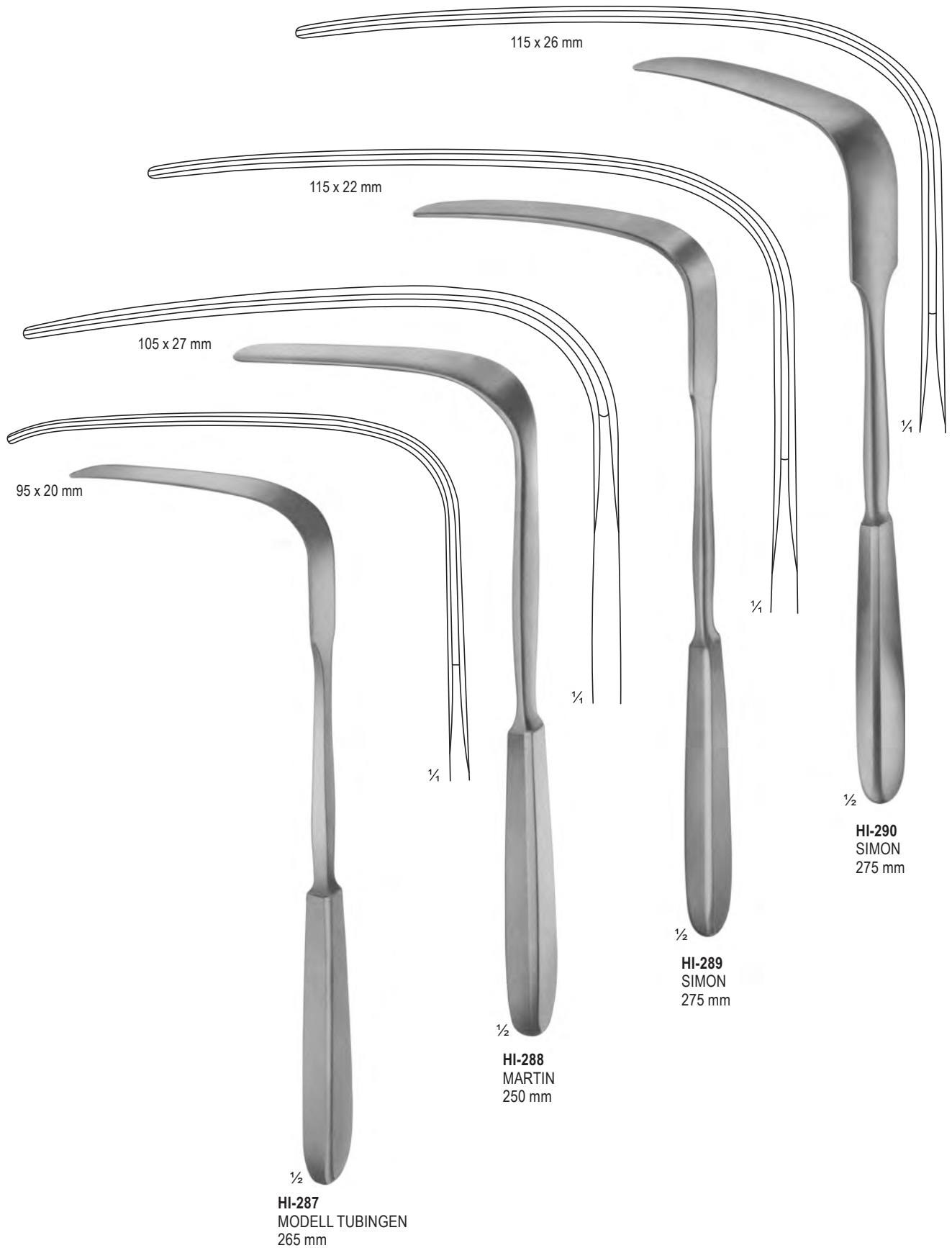

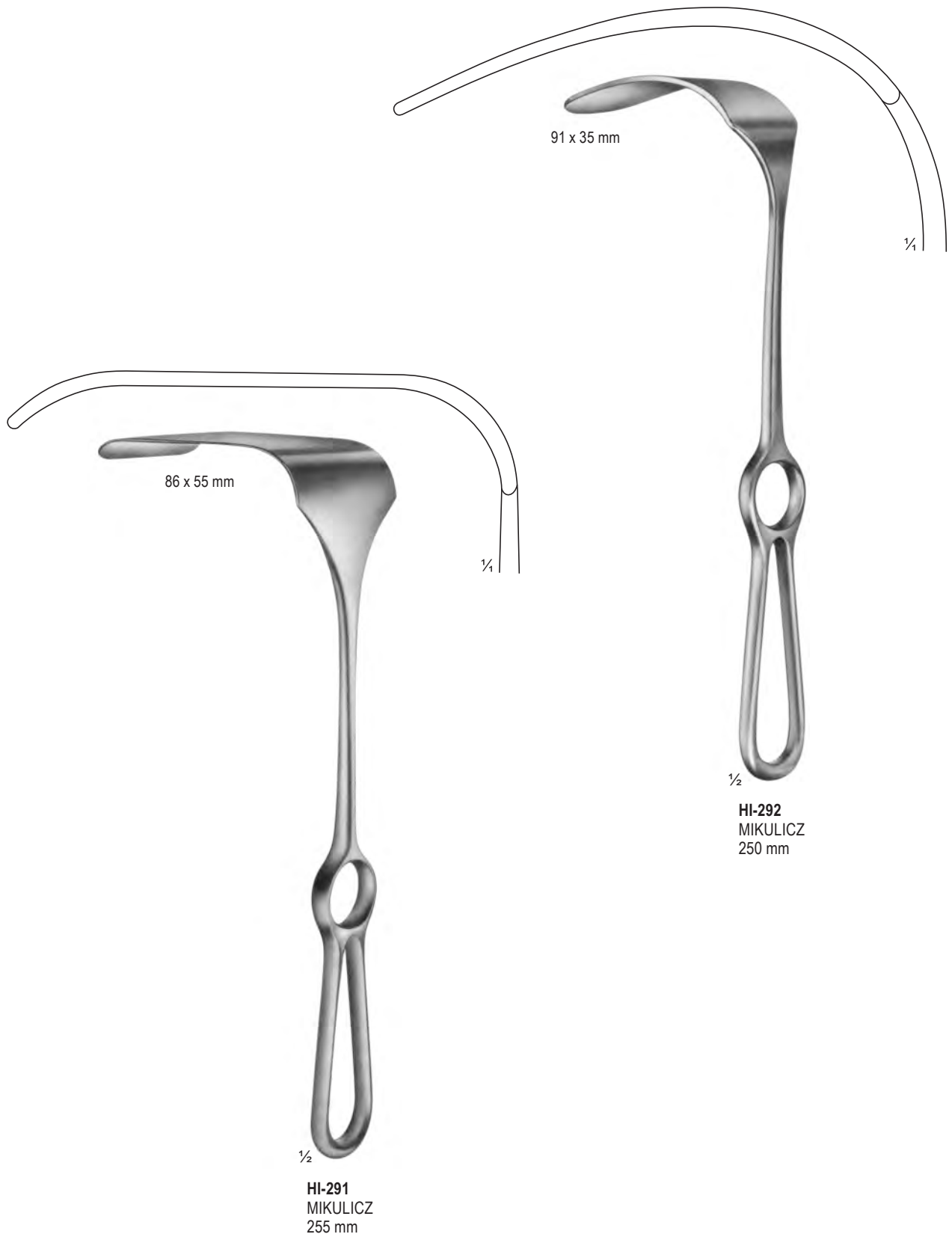

ABDOMINAL RETRACTORS

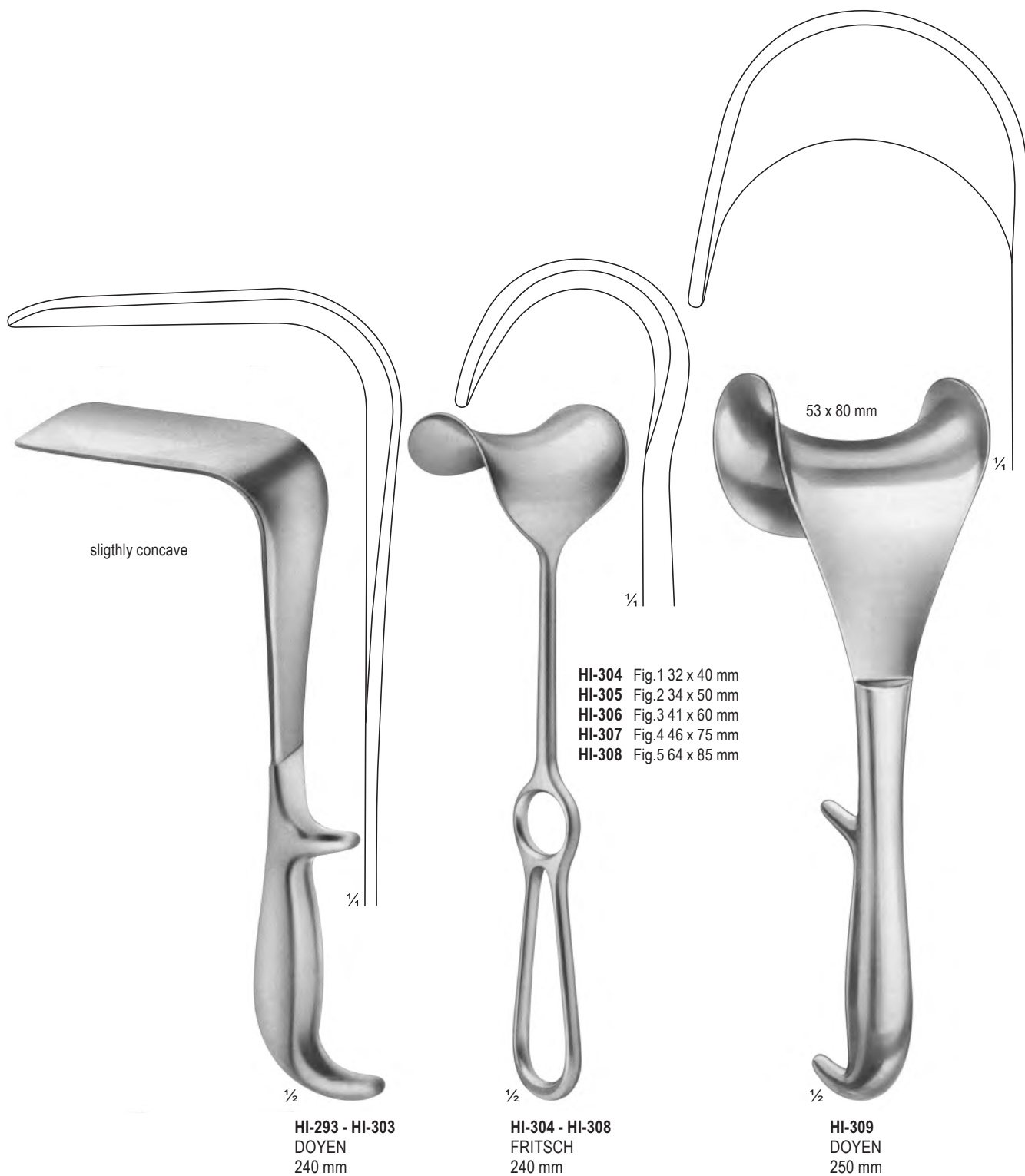

- HI-304 Fig.1 32 x 40 mm
- HI-305 Fig.2 34 x 50 mm
- HI-306 Fig.3 41 x 60 mm
- HI-307 Fig.4 46 x 75 mm
- HI-308 Fig.5 64 x 85 mm

HI-293 - HI-303
DOYEN
240 mm

HI-304 - HI-308
FRITSCH
240 mm

HI-309
DOYEN
250 mm

Width of Blades
35 mm, 45 mm, 60 mm

Length of Blades
62 mm HI-293 , HI-297 , HI-301
92 mm HI-294 , HI-298 , HI-302
122 mm HI-295 , HI-299 , HI-303
160 mm HI-296 , HI-300

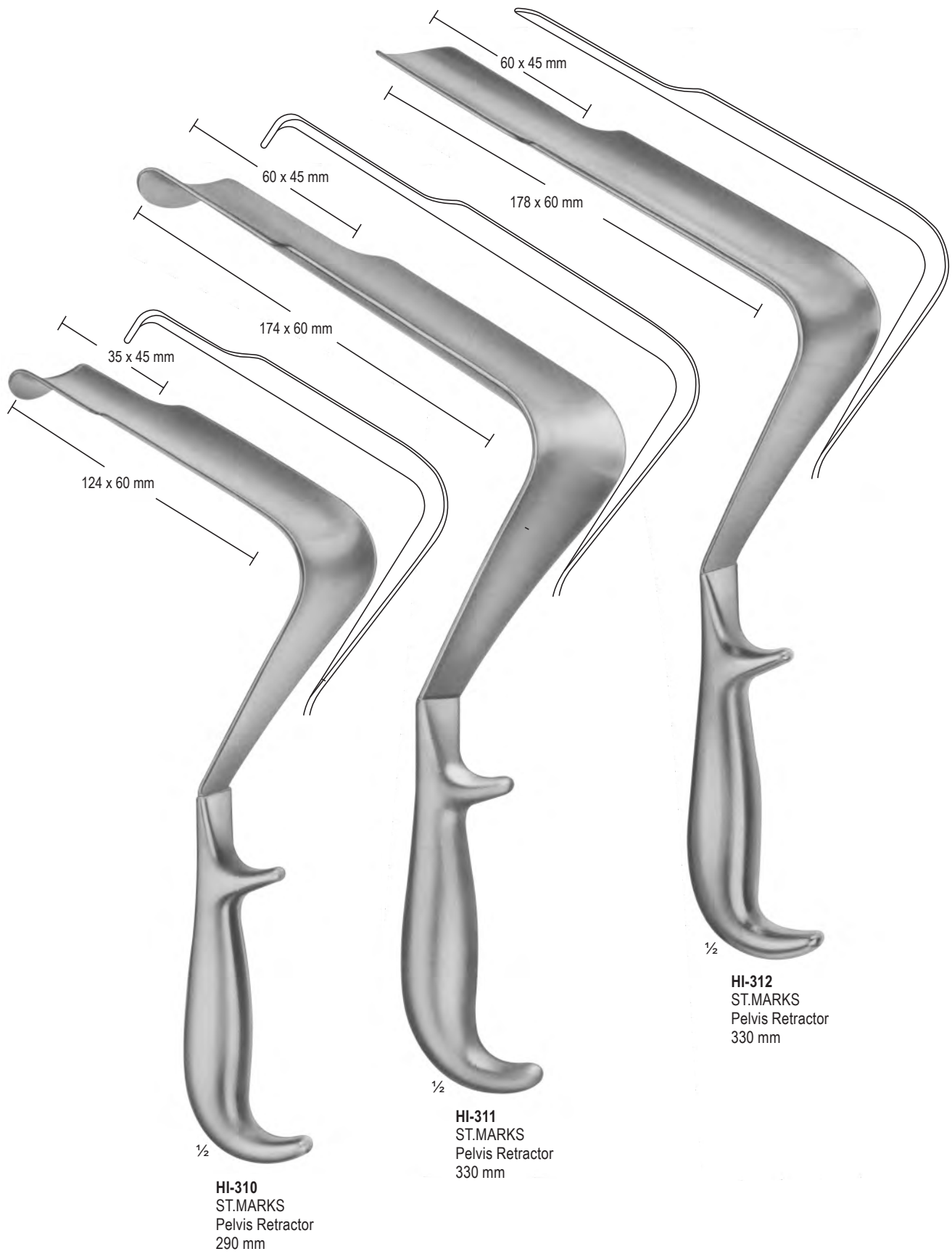

ABDOMINAL- AND INTESTINAL SPATULAS



1/2
HI-313
 LERICHE
 255 mm

1/2
HI-314
 KUMMEL
 Malleable
 285 mm

1/2
HI-315
 MIKULICZ
 29 mm
 250 mm

1/2
HI-316 - HI-317
 KADER
HI-316 30 mm
HI-317 40 mm
 270 mm



HI-318
REVERDIN
285 mm



HI-319
HABERER
Malleable
305 mm



HI-320 - 322
HI-320 30 mm
HI-321 40 mm
HI-322 50 mm
Malleable
330 mm



HI-323
TUFFIER
Malleable
200 mm



RETRACTORS

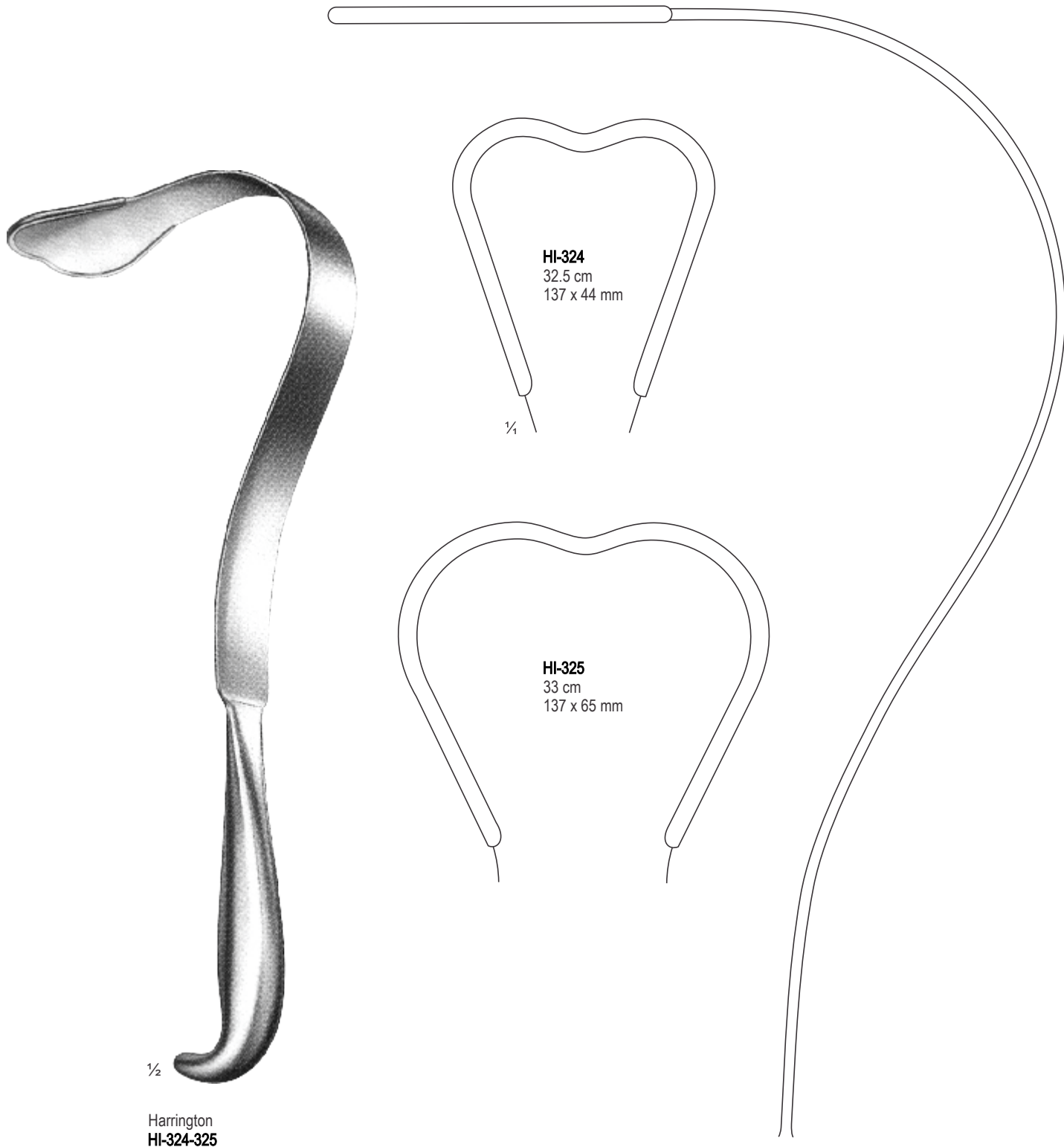



Deaver
HI-326
18 cm
19 mm

Deaver
HI-327
21.5 cm
22 mm

Deaver
HI-328
21.5 cm
25 mm

Deaver
HI-329
30.5 cm
25 mm

Deaver
HI-330
33.5 cm
25 mm